

**ADVERTIMENT.** La consulta d'aquesta tesi queda condicionada a l'acceptació de les següents condicions d'ús: La difusió d'aquesta tesi per mitjà del servei TDX ([www.tesisenxarxa.net](http://www.tesisenxarxa.net)) ha estat autoritzada pels titulars dels drets de propietat intel·lectual únicament per a usos privats emmarcats en activitats d'investigació i docència. No s'autoritza la seva reproducció amb finalitats de lucre ni la seva difusió i posada a disposició des d'un lloc aliè al servei TDX. No s'autoritza la presentació del seu contingut en una finestra o marc aliè a TDX (framing). Aquesta reserva de drets afecta tant al resum de presentació de la tesi com als seus continguts. En la utilització o cita de parts de la tesi és obligat indicar el nom de la persona autora.

**ADVERTENCIA.** La consulta de esta tesis queda condicionada a la aceptación de las siguientes condiciones de uso: La difusión de esta tesis por medio del servicio TDR ([www.tesisenred.net](http://www.tesisenred.net)) ha sido autorizada por los titulares de los derechos de propiedad intelectual únicamente para usos privados enmarcados en actividades de investigación y docencia. No se autoriza su reproducción con finalidades de lucro ni su difusión y puesta a disposición desde un sitio ajeno al servicio TDR. No se autoriza la presentación de su contenido en una ventana o marco ajeno a TDR (framing). Esta reserva de derechos afecta tanto al resumen de presentación de la tesis como a sus contenidos. En la utilización o cita de partes de la tesis es obligado indicar el nombre de la persona autora.

**WARNING.** On having consulted this thesis you're accepting the following use conditions: Spreading this thesis by the TDX ([www.tesisenxarxa.net](http://www.tesisenxarxa.net)) service has been authorized by the titular of the intellectual property rights only for private uses placed in investigation and teaching activities. Reproduction with lucrative aims is not authorized neither its spreading and availability from a site foreign to the TDX service. Introducing its content in a window or frame foreign to the TDX service is not authorized (framing). This rights affect to the presentation summary of the thesis as well as to its contents. In the using or citation of parts of the thesis it's obliged to indicate the name of the author



PLANTA MESANINA Y SALIDAS

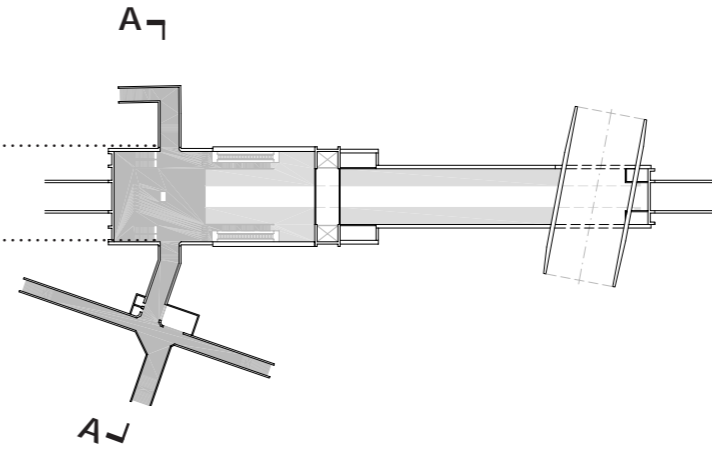

METRO DE SANTIAGO DE CHILE:

ESTACION **CENTRAL** / LINEA 1, 1ª ETAPA: 1975



SECCION A-A





METRO DE SANTIAGO DE CHILE:

## ESTACION CENTRAL / LINEA 1, 1ª ETAPA: 1975

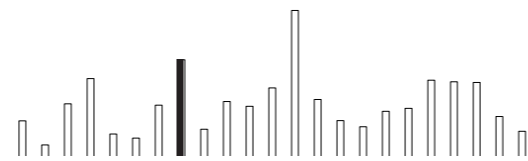

42.600 VIAJES/DIA (2005)





EMPLAZAMIENTO

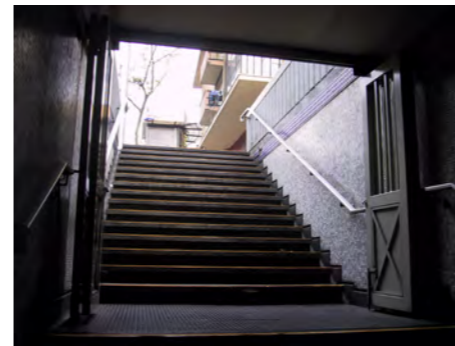
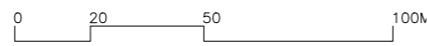

PLANTA MESANINA Y SALIDAS

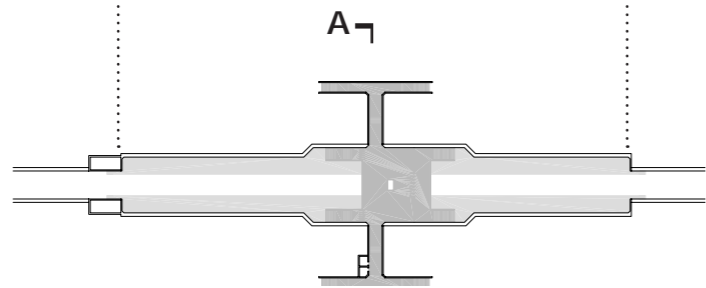

A-1

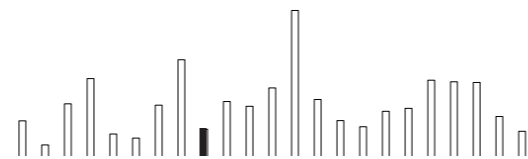

METRO DE SANTIAGO DE CHILE:

ESTACION U. L. A. / LINEA 1, 1ª ETAPA: 1975

12.000 VIAJES/DIA (2005)

A-2

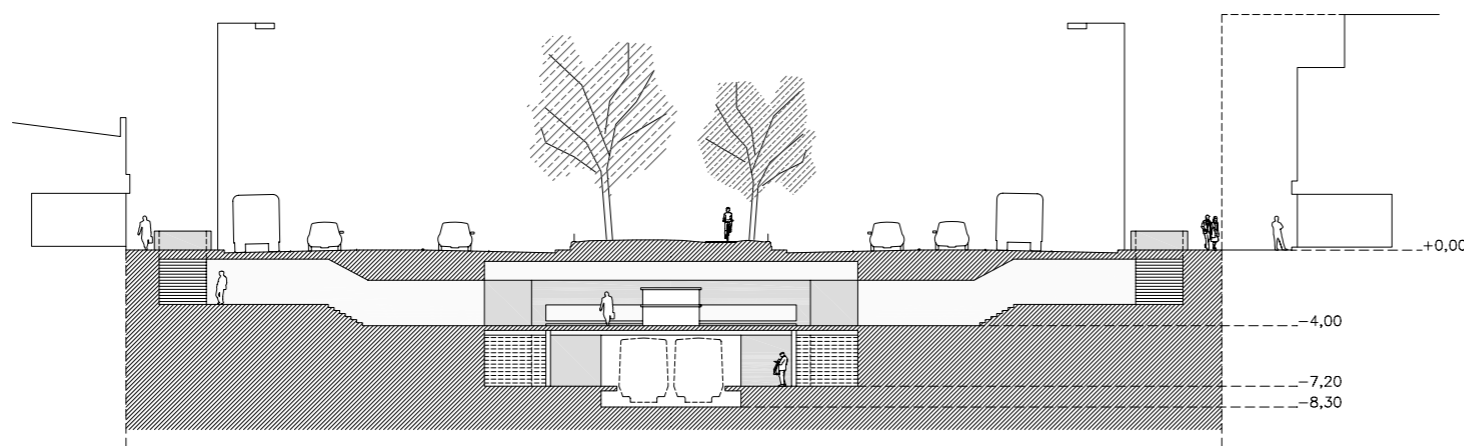

SECCION A-A

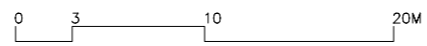



EMPLAZAMIENTO

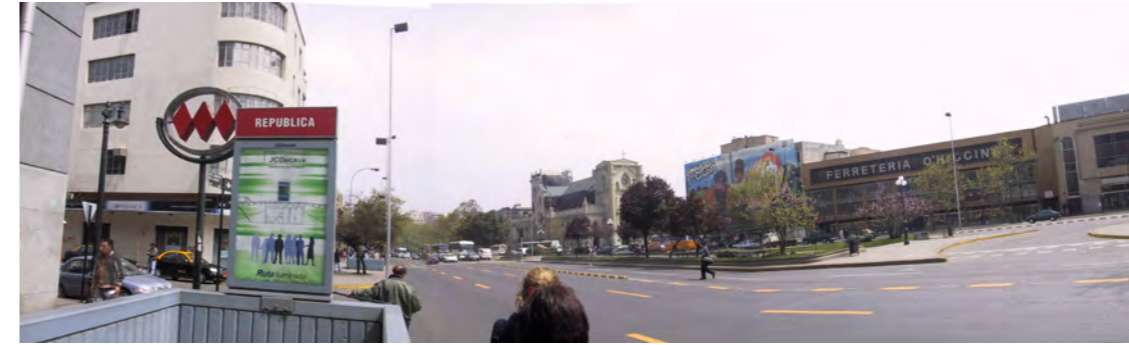

PLANTA MESANINA Y SALIDAS

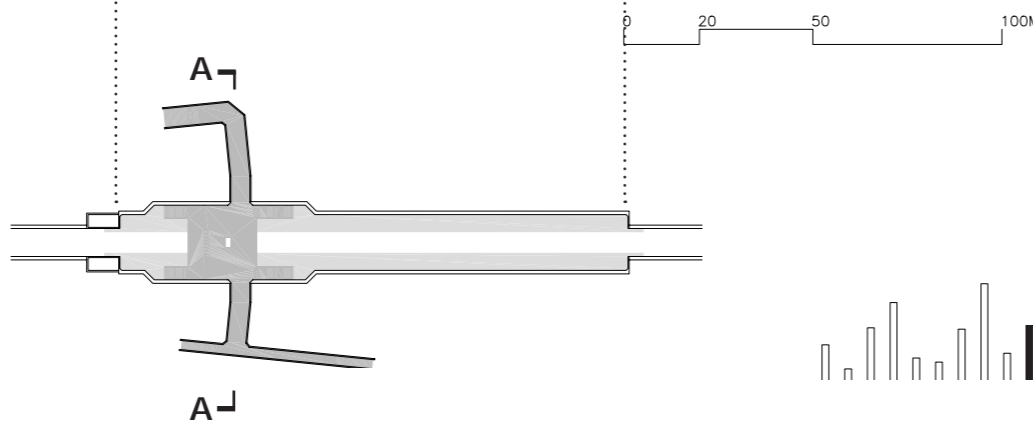

METRO DE SANTIAGO DE CHILE:

**ESTACION REPUBLICA / LINEA 1, 1ª ETAPA: 1975**

24.200 VIAJES/DIA (2005)

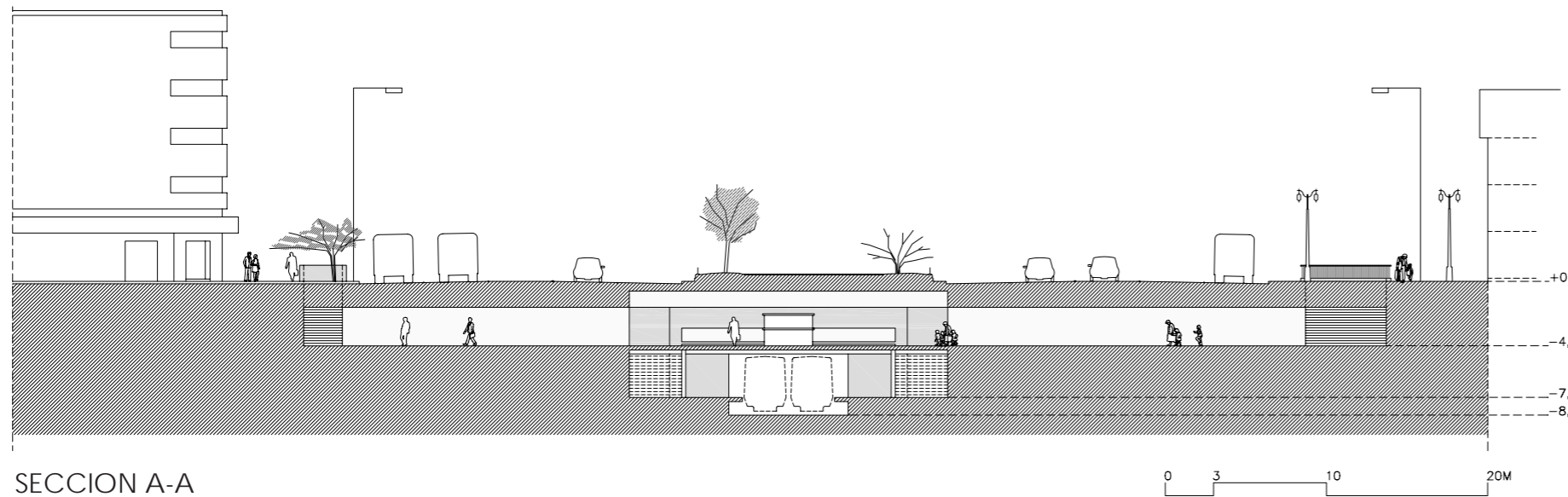
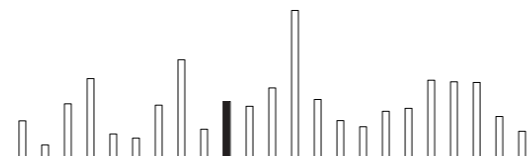

SECCION A-A

