



Universitat de les Illes Balears

Chemistry Department

DOCTORAL THESIS

Jessica Avivar Cerezo

2012



Universitat de les Illes Balears

Automated flow systems for total and
isotopic analysis of thorium and uranium
in samples of environmental interest

Doctoral Thesis

Jessica Avivar Cerezo

Palma de Mallorca, March 2012

Cover image: Gabriel Morell Capó

Cover design: David Lorenzo Patiño



Universitat de les Illes Balears

Dr. Víctor Cerdà Martín, Professor of Analytical Chemistry at the Chemistry Department of the University of the Balearic Islands and **Dr. Laura Ferrer Trovato**, director of the Laboratory of Environmental Radioactivity (LaboRA) of the University of the Balearic Islands, as directors of this Doctoral Thesis,

CERTIFY:

That the present work entitled: “Automated flow systems for total and isotopic analysis of thorium and uranium in samples of environmental interest” has been developed by Jessica Avivar Cerezo at the research group Analytical Chemistry, Automation and Environment of the Chemistry Department of the University of the Balearic Islands, as a requirement to get the degree of Doctor in Chemical Science and Technology, with European mention.

Palma de Mallorca, 3rd February 2012

Dr. Víctor Cerdà Martín

Dr. Laura Ferrer Trovato



Universitat de les Illes Balears

El **Dr. Víctor Cerdà Martín**, Catedrático de Química Analítica del Departamento de Química de la Universitat de les Illes Balears y la **Dra. Laura Ferrer Trovato**, directora del Laboratorio de Radioactividad Ambiental (LaboRA) de la Universitat de les Illes Balears, en calidad de directores de esta tesis doctoral,

HACEN CONSTAR:

Que el presente trabajo titulado: “Automated flow systems for total and isotopic analysis of thorium and uranium in samples of environmental interest” ha sido realizado por Jessica Avivar Cerezo en el grupo de Química Analítica, Automatización y Medioambiente del Departamento de Química de la Universitat de les Illes Balears, como requisito para optar al Título de Doctor en Ciencia y Tecnología Química, con mención europea.

Palma de Mallorca, 3 de Febrero de 2012

Dr. Víctor Cerdà Martín

Dra. Laura Ferrer Trovato

ACKNOWLEDGEMENTS/ AGRADECIMIENTOS

To all the people who in one way or another have helped me, supported me and shared with me all these years in which has been carried out this thesis.

To Víctor Cerdà and Laura Ferrer for being my supervisors, for their support throughout all this time and for being directly responsible for this work. Also, for their optimism and for making of every moment a great memory.

To Montserrat Casas for her time, suggestions and excellent contributions.

To the University of the Balearic Islands for the collaboration grant 2008/81.

To Jose Manuel Estela for introducing me in the group as a collaborator-student. All this would not have been possible if he would have not trusted on me.

To Gillian M. Greenway for giving me the opportunity to work in her laboratory, and her support during my stay at the University of Hull. To all the people in the lab of Hull for making of my stay a great experience.

To the College of Chemists of the Balearic Islands, for the 2010 St. Albert Chemical Research award.

Especially to all the colleagues of the laboratory, with whom I've had the pleasure to work during all these years, for all the good times we've had together in the lab and outside of it and for every wonderful day we've spent together. Also to all the visitors who have been at our lab.

To Rogelio Rodriguez and Montse Mola for all the fun we had working together and for their innate charm and friendliness.

To Lindomar Portugal and José González for their advice and their help.

To my friends (to my sister and best friend Marie, David, Marina, Gabi and David) for always being there, listening, helping me and providing me a lot of joy. To Gabi for the photographs and to David for the cover design.

To my family because I am who I am because of them, for being part of everything I do and of my daily life. And because they are the most important and the best of my life. To whom I dedicate this thesis.

To all and every one of you thanks for everything.

A todas aquellas personas, que de un modo u otro me han ayudado, apoyado y han compartido estos años en los que ha sido llevada a cabo esta tesis.

A Víctor Cerdà y Laura Ferrer por ser mis directores de tesis, por su apoyo durante todo este tiempo y por ser directamente responsables de este trabajo. Por su optimismo y por hacer que todos y cada uno de mis recuerdos sean maravillosos.

A Montserrat Casas por su tiempo, sugerencias y excelentes aportaciones.

A la Universidad de las Islas Baleares por concederme la beca de colaboración 2008/81.

A José Manuel Estela por introducirme en el grupo como alumna colaboradora, todo esto no habría sido posible si no hubiera confiado en mí.

A Gillian M. Greenway por darme la oportunidad de trabajar en su laboratorio, y el apoyo recibido durante mi estancia en la Universidad de Hull. A todos los compañeros del laboratorio de Hull por hacer de mi estancia una gran experiencia.

Al Colegio de Químicos de las Islas Baleares, por la concesión del premio San Alberto de Investigación Química 2010.

En especial a todos los compañeros del laboratorio, con los que he tenido el placer de trabajar durante todos estos años, por todos los buenos momentos que hemos vivido en el laboratorio y fuera de él y por un ambiente y un día a día maravilloso. También a todos los visitantes que han pasado por el laboratorio.

A Rogelio Rodríguez y Montse Mola por lo bien que lo hemos pasado trabajando juntos, por su alegría y simpatía innata.

A Lindomar Portugal y José González por sus consejos y gran ayuda.

A mis amigos (mi hermana y mejor amiga Marie, David, Marina, Gabi y David) por estar ahí, escuchando, ayudándome a desconectar y dándome alegrías. A Gabi por las fotos y a David por el diseño de la portada.

A mi familia porque soy cómo soy gracias a ellos, por formar parte de lo que hago y de mi día a día. Y porque son lo más importante y lo mejor de mi vida. A quienes dedico esta tesis.

A todos y cada uno gracias.

Abbreviations

BI: Bead injection

CMPO: octylphenyl-N,N-di-isobutyl carbamoylphosphine oxide

CSN: Consejo de Seguridad Nuclear

DAAP: Diamyl, amyl phosphonate

ETFE: poly(ethylene-co-tetrafluoroethylene)

EURATOM: European Atomic Energy Community

FIA: Flow injection analysis

IAEA: International Atomic Energy Agency

IUPAC: International Union of Pure and Applied Chemistry

ICP-MS: Inductively coupled plasma mass spectrometry/spectrometer

LOD: Limit of detection

LOV: Lab-on-valve

LWCC: Liquid waveguide capillary cell

MCFIA: Multicommutated flow injection analysis

MPFS: Multipumping flow system

MSFIA: Multisyringe flow injection analysis

NORM: Naturally occurring radioactive materials

PTFE: poly(tetrafluoroethylene)

PVDF: polyvinylidene fluoride

SIA: Sequential injection analysis

SPE: Solid phase extraction

TBP: tri-n-butyl phosphate

TENORM: Technically enhanced naturally occurring radioactive materials

TEVA[®]: Tetravalent actinides and technetium resin

TRU: Transuranide resin

UNSCEAR: United Nations Scientific Committee on the Effects of Atomic Radiation

USEPA: United States Environmental Protection Agency

UTEVA[®]: Uranium and tetravalent actinide resin

WHO: World Health Organization

Index

Abstract	1
Resumen	3
Chapter 1 General Introduction	5
1.1 Uranium and thorium generalities	7
1.1.1 Natural Radioactivity	8
1.1.2 Anthropogenic radioactivity	11
1.1.3 Uranium	12
1.1.4 Thorium	13
1.1.5 Legislation	15
1.2 Laboratory automation	17
1.2.1 Multisyringe flow injection analysis – MSFIA	17
1.2.2 Multipumping flow systems – MPFS	18
1.2.3 Lab-on-Valve – LOV.....	19
1.3 Detectors	21
1.3.1 Spectrophotometric detection	21
1.3.2 Inductively Coupled Plasma Mass Spectrometry - ICP-MS	22
1.4 Solid phase extraction-SPE	24
1.5 Objectives	27
1.6 Submitted manuscript	28
Chapter 2 State of the art of automation in radiochemical analysis	53
2.1 Introduction	55
2.2 Original paper	57
Chapter 3 Experimental section: instrumentation and common materials.....	69
3.1 Flow instrumentation.....	71
3.1.1 Multisyringe burette.....	71
3.1.2 Multipumping flow system.....	73
3.1.3 Lab-on-valve.....	75
3.1.4 Manifold components	76
3.2 Detectors	77
3.2.1 Spectrophotometric detection basis.....	77
3.2.2 ICP-MS detection.....	80
3.3 Separation and preconcentration techniques used	85
3.3.1 TRU resin.....	85
3.3.2 UTEVA [®] resin.....	86

3.4 Software.....	88
3.4.1 System configuration.....	88
3.4.2 Method edition.....	89
3.4.3 Data processing.....	90
3.5 Multivariate optimization	92
3.5.1 Screening.....	94
3.5.1.1 Factorial designs.....	94
3.5.2 Response surface.....	95
3.5.2.1 Desirability function.....	97
Chapter 4 Automated determination of uranium(VI) at ultra trace levels exploiting flow techniques and spectrophotometric detection using a liquid waveguide capillary cell.....	99
4.1 Introduction.....	101
4.2 Original paper.....	102
4.3 Additional optimization information.....	111
Chapter 5 Lab on valve-multisyringe flow injection system (LOV-MSFIA) for fully automated uranium determination in environmental samples	119
5.1 Introduction.....	121
5.2 Original paper.....	123
5.3 Additional optimization information.....	133
Chapter 6 Smart thorium and uranium determination exploiting renewable solid-phase extraction applied to environmental samples in a wide concentration range.....	141
6.1 Introduction.....	143
6.2 Original paper.....	144
6.3 Additional optimization information.....	155
Chapter 7 Fully automated LOV-MSFIA-ICP-MS system: an effective tool for fast, sensitive and selective determination of thorium and uranium at environmental levels exploiting solid phase extraction.....	171
7.1 Introduction.....	173
7.2 Original paper.....	174
7.3 Additional optimization information.....	183
Chapter 8 Conclusions.....	195
Conclusiones.....	199
Annex	201

Abstract

As a result of the different uses of radioactivity during the last decades, there has been an increase in the concentration of natural and artificial radionuclides in the environment. This together with some accidents with high impact on the public opinion (e.g. Chernobyl and Fukushima) has led to establish or increase environmental radioactivity monitoring programs. Actually, present trends in legislation and research are focused in the development of accurate, precise, reliable and rapid analytical methods with low detection limits to determine radionuclides, such as thorium and uranium, in environmental samples.

In this thesis, two comprehensive reviews and four automated analytical systems for total and isotopic thorium and uranium determination are presented. The developed methods have been applied to environmental samples with low concentrations of the above cited elements. These methodologies have been automated exploiting multicommutated flow techniques, such as Multisyringe Flow Injection Analysis (MSFIA), Multipumping Flow Systems (MPFS) and Lab-on-valve (LOV), which provide minimal sample handling, low reagent consumption and waste generation and a high frequency of analysis. Long path length spectrophotometry and ICP-MS have been implemented in the developed methods as detection techniques instead of radiometric detectors in order to obtain fully automated, low cost and fast thorium and uranium analyzers.

The works presented are listed below:

1. A comprehensive review with a detailed description of flow techniques, their evolution, their hyphenation advantages and a critical comparison between current developed methods exploiting flow techniques aimed to solve present analytical needs.
2. The state of the art of flow analysis applied to the fully automated and semi-automated determination of radioactive isotopes in environmental samples, including automatic procedures for separation and preconcentration of radioisotopes is reviewed. We discuss in detail advantages and drawbacks of automatic protocols exploiting various generations of flow techniques using a variety of detection systems, including scintillation counting, α -spectrometers, proportional counters, mass spectrometry and spectrophotometry.

3. An automated, low-cost, robust, portable and rapid MSFIA-MPFS analyzer for total uranium determination in environmental samples exploiting solid phase extraction (SPE) using TRU resin and spectrophotometric detection with a liquid waveguide capillary cell.
4. A LOV-MSFIA method with spectrophotometric detection for total uranium determination going a step forward by automating the column replacement of the SPE exploiting the LOV technique and the UTEVA[®] resin. In this method the amount of resin used is reduced and its reuse is increased.
5. A fully automated multiparametric smart LOV-MSFIA analyzer with spectrophotometric detection for total thorium and uranium determination in samples of environmental interest in a wide concentration range. On-line separation and preconcentration of thorium and uranium are carried out by means of UTEVA[®] resin. The main feature of this analyzer is its capability to work autonomously and to take its own decisions thanks to the implementation of feedback mechanisms in the control software.
6. A LOV-MSFIA-ICP-MS system for simultaneous and isotopic analysis of thorium and uranium at trace levels. This system has proved to be an effective tool for fast, isotopic, sensitive and selective determination of thorium and uranium at environmental levels exploiting solid phase extraction by UTEVA[®] resin.

Resumen

En las últimas décadas, como consecuencia de los diferentes usos de la radioactividad, se ha ido produciendo un aumento en las concentraciones de diferentes radionúclidos, tanto artificiales como naturales, que se encuentran hoy en el medio ambiente. Esto, junto a algunos accidentes de amplia repercusión en la opinión pública (Chernóbil, Fukushima), ha llevado a establecer o incrementar los programas de vigilancia de radioactividad ambiental. De hecho, las nuevas tendencias en legislación y en investigación están dirigidas hacia el desarrollo de métodos exactos, precisos, robustos y rápidos con bajos límites de detección para determinar radionúclidos, tales como torio y uranio, en muestras ambientales.

En esta tesis se presentan dos revisiones exhaustivas y cuatro métodos analíticos para la determinación total e isotópica de torio y uranio. Los métodos desarrollados han sido aplicados a muestras ambientales con bajas concentraciones de los analitos de interés. Estas metodologías han sido automatizadas mediante el uso de técnicas de análisis en flujo multiconmutadas, tales como Análisis por Inyección en Flujo Multijeringa (MSFIA), Sistemas de Flujo Multibomba (MPFS) y Lab-on-valve (LOV), que proporcionan un importante ahorro de reactivos, con la consecuente reducción de coste por análisis y de generación de residuos permitiendo una mayor frecuencia de análisis, y una mínima manipulación de las muestras. La espectrofotometría de largo paso óptico y el ICP-MS fueron las técnicas de detección utilizadas en los métodos desarrollados como alternativas a detectores radiométricos con el fin de obtener métodos para torio y uranio totalmente automáticos, económicos y rápidos.

Los trabajos presentados son los siguientes:

1. Una revisión exhaustiva con una descripción detallada de las técnicas de análisis en flujo, su evolución, las ventajas de su acoplamiento y una comparación crítica de métodos recientemente desarrollados, basados en técnicas de flujo, con el objetivo de solventar necesidades analíticas actuales.
2. Una revisión del estado actual de la aplicación de las técnicas de análisis en flujo para la determinación totalmente automática y semiautomática de isótopos radioactivos en muestras ambientales, incluyendo procedimientos de separación y preconcentración de radioisótopos. En la que se discuten en detalle las ventajas y desventajas de protocolos automáticos utilizando diferentes generaciones de técnicas de análisis en

flujo y una variedad de sistemas de detección, incluyendo contadores de centelleo, espectrofotómetros alfa, contadores proporcionales, espectrometría de masas y espectrofotometría.

3. Un método MSFIA-MPFS rápido, económico, portátil y robusto, para la separación, preconcentración y determinación de uranio total en muestras ambientales, mediante extracción en fase sólida usando resina TRU y detección espectrofotométrica con una celda de largo paso óptico.
4. Un método LOV-MSFIA con detección espectrofotométrica para la determinación de uranio total, aumentando el grado de automatización con la renovación automática de la resina (UTEVA[®]) gracias a la técnica LOV. Con este método se consigue reducir la cantidad de resina utilizada y aumentar su reutilización.
5. Un sistema inteligente LOV-MSFIA multiparamétrico y totalmente automatizado para la determinación de torio y uranio en un amplio rango de concentraciones en muestras de interés ambiental. La separación y preconcentración en línea de torio y uranio se lleva a cabo con la resina UTEVA[®]. El rasgo más característico de este analizador es su capacidad para trabajar de forma autónoma y para tomar sus propias decisiones gracias a la implementación de mecanismos de retroalimentación en el software que controla el equipo.
6. Un sistema LOV-MSFIA-ICP-MS para el análisis simultáneo e isotópico de torio y uranio a niveles traza. Este sistema ha demostrado ser una herramienta efectiva para la determinación selectiva y rápida de torio y uranio a niveles ambientales utilizando la técnica de extracción en fase sólida con la resina UTEVA[®].

Chapter 1

General introduction

In this chapter, a general introduction to the analytes of interest, the applied and related analytical techniques used and the objectives for this thesis are presented.

1.1 Uranium and thorium generalities

Radioactive substances are defined as materials that contain unstable atoms which produce ionizing radiation through nuclear rearrangement. Radionuclides are widely distributed on Earth, partitioned between the atmosphere and the lithosphere. Over 320 isotopes have been currently identified in nature. The radioactivity on Earth consists of naturally produced radioisotopes and anthropogenic radioactive contamination initiated during the nuclear era. The wide use of nuclear power and nuclear waste disposal plants have made the public increasingly concerned about health hazards of radionuclide in nature.

Uranium and thorium are natural radioactive occurring elements members of the actinide series. Actinides are considered the most toxic radionuclides in the environment, as most of them are alpha emitters and have long half-lives. Alpha particles (α) consist of two protons and two neutrons bound together into a particle identical to a helium nucleus (${}^4_2\text{He}^{+2}$). Despite the low penetration capacity of these particles, they are dangerous due to their high ionizing energy.

Uranium and thorium isotopes determination has historically been a subject of interest mostly within the fields of geochronology and geochemistry. In recent years uranium isotopes has also been of major interest within the field of nuclear forensic analysis. Moreover, determination of uranium and thorium in environmental and biological samples has considerable potential as a tool for assessing human exposure. Despite the relatively low specific activity of natural uranium and thorium isotopes, there exists an important health concern because of their chemical toxicity and radio toxicity of their decay products.

These elements are enriched through numerous food chains to humans and, even in small amounts, can cause health hazards. The effective dose equivalent for a person due to natural radioactivity is in the range of 2-3 mSv per year. Some changes in blood cells can be observed above few hundreds of millisieverts obtained in a short time, whereas above 1 Sv, symptoms of acute radiation disease can be observed. There is a 50 % risk of death with an effective dose of 4 Sv and above 10 Sv it results in certain death¹. The increase in cancer risk or cancer mortality is the main factor taken into consideration. Another hazard related to radiation is the increase in mutation rate. Uranium and thorium are known to cause acute toxicological effects for human and their compounds are potential occupational carcinogens. These elements and compounds are highly toxic which cause progressive or irreversible renal injury².

¹ J.W. Mietelski. Anthropogenic radioactivity, in Radionuclides in the Environment, D. A. Atwood (Ed.), Wiley & sons, 2010. Chapter 2, 19-34.

² C. Galindo, L. Mougin, A. Nourredin. An improved radiochemical separation of uranium and thorium in environmental samples involving peroxide fusion. *Appl. Radiat. Isot.* 65 (2007) 9-16.

1.1.1 Natural radioactivity

The natural ionizing radiation present on our planet comes from many sources and generates most of the radioactivity that surrounds us. Radioactivity initiated by the successive decay of ^{232}Th , ^{235}U and ^{238}U is essentially responsible for the presence of radioisotopes of lead, polonium, bismuth, astatine, radon, francium, radium and protactinium on Earth³. Because of the short half-lives of these radioisotopes, which belong to the decay series of uranium and thorium, with respect to Earth's geologic timescale (4.6×10^9 years), the decay of these radionuclides is responsible for a significant portion of the radiation doses from natural radioactivity received by humans. With the exception of radiation exposure for medical purposes, natural radioactivity is responsible for the majority of the dose received by humans.

Natural radioactivity can be categorized into three categories based on the origin of production of the radioisotope: cosmogenic radionuclides, primordial radionuclides (defined as radionuclides present since the formation of Earth about 4.6×10^9 years ago) and radioactive decay series. Uranium (^{238}U and ^{235}U) and thorium (^{232}Th) are primordial radionuclides and radionuclides from natural decay series (^{230}Th , ^{234}Th , ^{227}Th , ^{228}Th , ^{229}Th , ^{231}Th , ^{233}U , ^{234}U) (Fig. 1.1). The vast majority of the natural radioactivity detected on Earth and its related dose results from radionuclides belonging to the decay series which have primordial origins (Fig. 1.2). Radon comes from the natural uranium found on Earth and is responsible for a significant part of the radioactivity received by human beings, as can be seen in Fig. 1.3. Actually, of the 3.71 mSv received per year by a Spanish citizen, 2.40 mSv are from natural radioactive sources⁴.

³ D. Larivière, N. Guérin. Natural radioactivity, in *Radionuclides in the Environment*, D. A. Atwood (Ed.), Wiley & sons, 2010. Chapter 1, 1-17.

⁴ Dosis de radiación, CSN (Consejo de Seguridad Nuclear), 2009. Legal deposit: M-26655-2004.

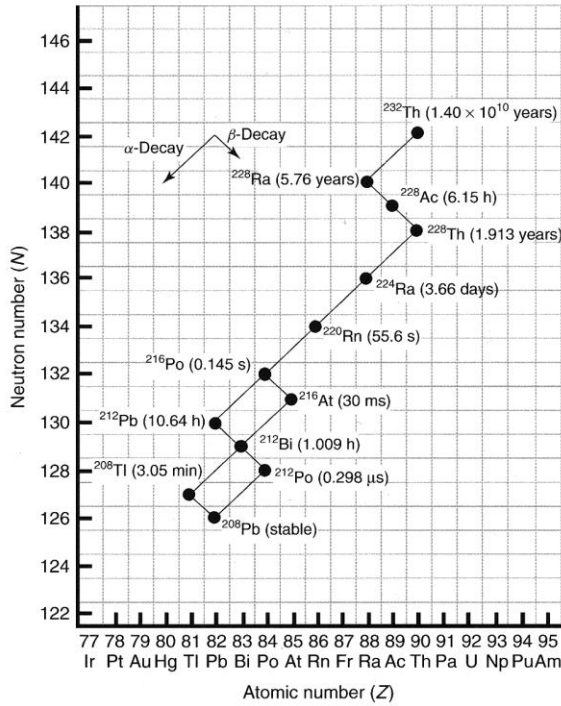

Thorium radioactive decay series (4n series)

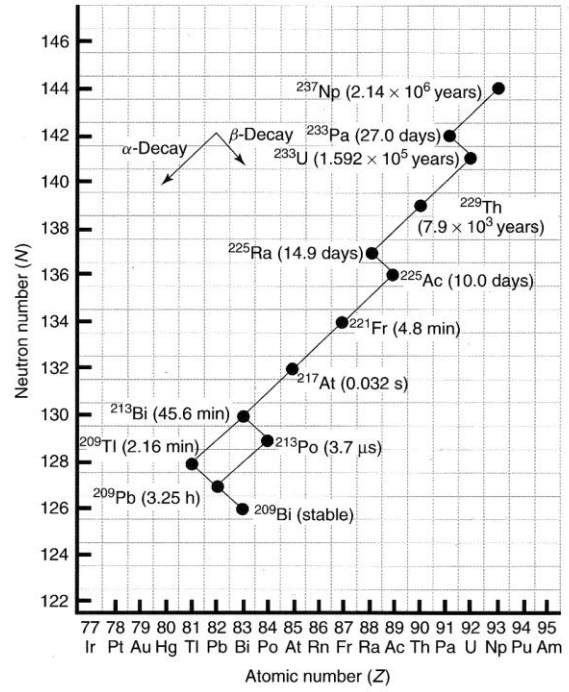

Neptunium radioactive decay series (4n + 1 series)

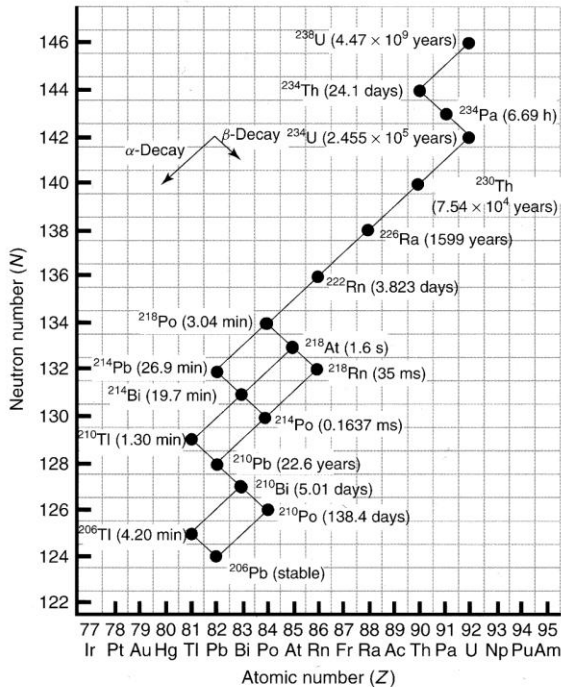

Uranium radioactive decay series (4n + 2 series)

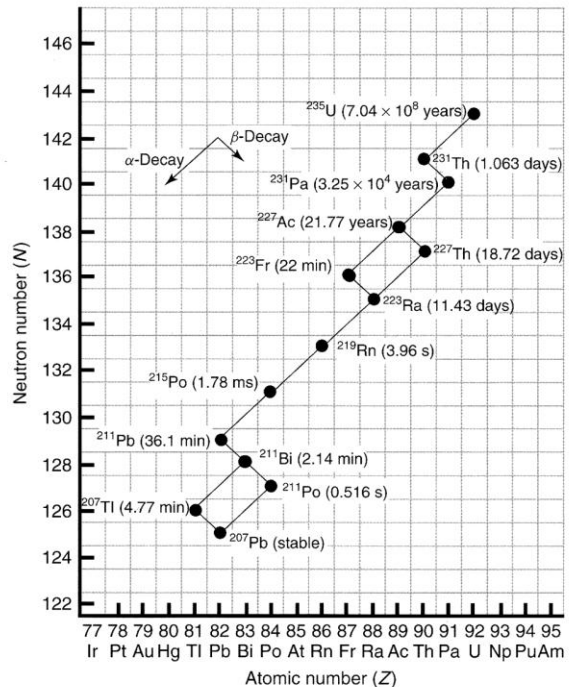

Actinium radioactive decay series (4n + 3 series)

Figure 1.1 Natural decay series.

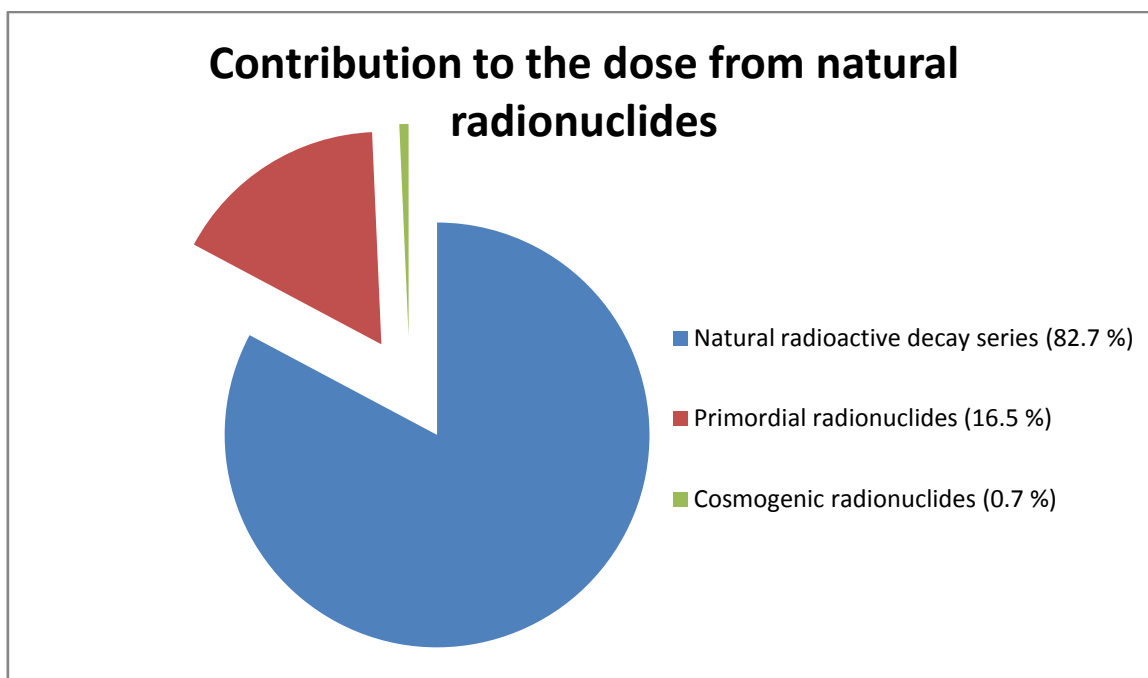

Figure 1.2 Percentage of contribution to the dose from natural radionuclides³.

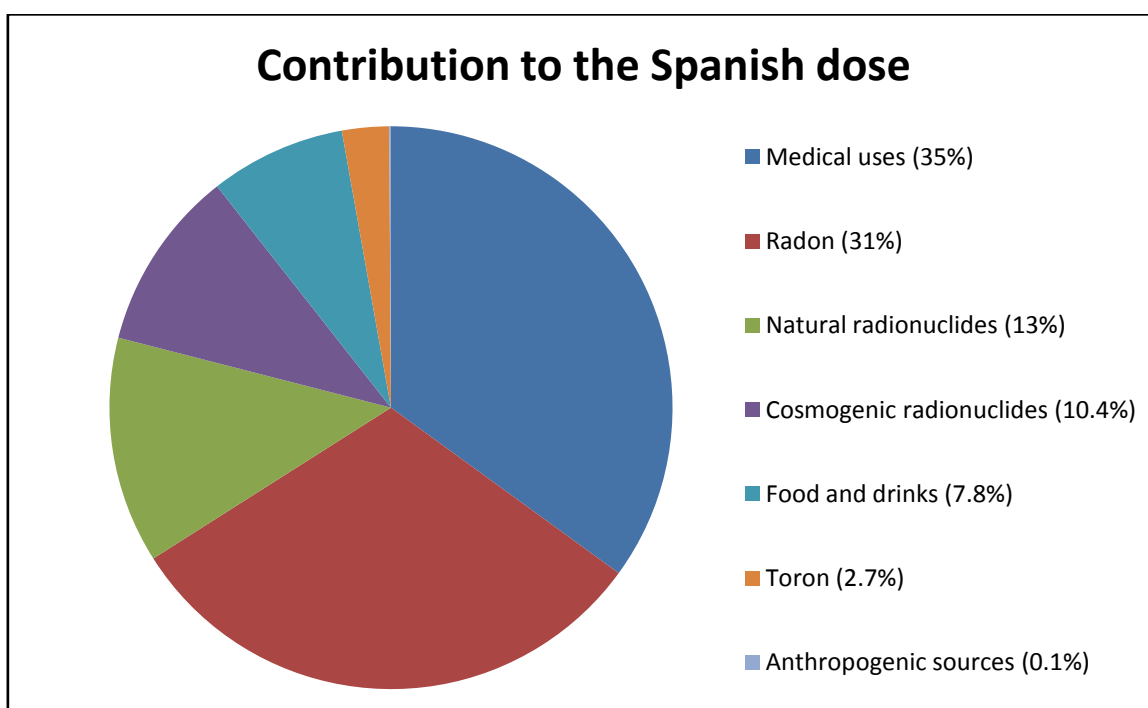

Figure 1.3 Percentage of contribution to the dose received by a Spanish citizen per year (3.71 mSv)⁴.

1.1.2 Anthropogenic radioactivity

The term anthropogenic radioactivity covers sources of radioactivity not present on the Earth in measurable amounts before the nuclear era (the so-called artificial radioactivity) and technically enhanced natural radioactivity (TENORM).

TENORM are the result of human activities that transform natural resources containing naturally occurring radioactive materials (NORM), generating by-products that find their way into the environment. Thus, TENORM are responsible for the distribution of many natural radionuclides in the environment. Mining and processing of ores, fossil fuel use or production of natural gas and oil⁵, fertilizer production, smelting, and water treatment and purification are examples of human activities known to modify the level of environmental radioactivity, especially in soil, water and air. For example, agricultural phosphorous, essential for the development of crops, is obtained from phosphate rocks found in sedimentation formations. These formations contain trace quantities of uranium, thorium and their progenies, incorporated in the structure of the mineral. During the treatment of phosphate rocks with sulfuric acid to form phosphoric acid, radionuclides become partitioned between the products and the waste stream. Typically, ²²⁶Ra (~80%), ²³²Th (~30%) and ²³⁸U (~14%) are left in the phosphogypsum produced through this approach⁶. Furthermore, in the fertilizer, uranium and thorium concentrations are generally approximately 150% of their original concentration in the phosphate rock. Radionuclides dispersed on agricultural land via the spreading of fertilizers are redistributed in the environment by means of soil erosion and surface water runoff. In the south of Spain, and between many chemical industries, there is one in Huelva dedicated to the production of phosphoric acid, from which a phosphogypsum sample was analyzed with some of the proposed methods in this thesis. This factory produces annually almost two million tons of sulfuric acid, phosphoric acid and ammonium phosphates, which are commercialized as such or used as intermediates to obtain: diammonium phosphate (DAP), complex fertilizers and soluble phosphates. There is another factory dedicated to produce titanium dioxide, which also works with raw materials (ilmenite) with high activity concentrations of natural radionuclides. An interesting study evaluating the radiologic impact of these two non-nuclear industries in the south of Spain was presented by the CSN⁷. Many geological and environmental events such as volcanic action, droughts, floods, hydrothermal

⁵ IAEA (International Atomic Energy Agency). Extent of Environmental Contamination by Naturally Occurring Radioactive Material (NORM) and Technological Options for Mitigation, Technical Reports Series 419, Vienna (2003), available at <http://www-pub.iaea.org/MTCD/publications/SeriesMain.asp>.

⁶ M.B. Cooper. Naturally occurring radioactive materials (NORM) in Australian industries – Review of current inventories and future generation. Rep. ERS-006, EnviroRad Services, Beaumaris, Australia, 2003.

⁷ Estudio y evaluación del impacto radiológico producido por las actividades de diversas industrias no nucleares del sur de España. CSN (Consejo de Seguridad Nuclear), Technical reports, 26, 2010. Legal deposit: M-52289-2010.

activity, ice melting, snow cap removal, earthquakes, and forest fire can also modify, as human activity does, the distribution of naturally occurring radionuclides.

There are several sources of anthropogenic radionuclides in the environment, e.g. nuclear weapons testing, nuclear industries, nuclear medicine (e. g. some radionuclides are used with diagnosis purposes and some for cancer treatment) and research laboratories. The most important are the military applications of nuclear energy. Officially, 2418 nuclear test explosions and two combat ones (Hiroshima and Nagasaki) have taken place on the Earth since 1945. Regarding to the dose received by humans, the UNSCEAR⁸ estimates that a citizen of a developed country receives 1.28 mSv per year from medical exposure (see Fig.1.3).

1.1.3 Uranium

Uranium is widely distributed throughout the world. It is a naturally occurring element member of the actinide series. It is found in all rocks and soils, as well as in natural water samples. The uranium content in various common rock types ranges between 0.5 and 4.7 mg kg⁻¹ (ppm). Mineral resources such as phosphate ore, monazite sands, or copper ore can have much higher uranium contents up to a factor of 5-1500 higher⁹. In Spain, there are some projects related to uranium mining in stand-by due to political, environmental and economical concerns. Spain is supposed to have the second largest global reserves of uranium, previously managed by the company ENUSA, which stopped its mining activities in 1994 due to profitability reasons. During the last years, there has been an increasing interest of some international companies (Berkeley Resources and Mawson) in exploiting the mines of uranium. In 2009, Berkeley Resources and ENUSA formed a consortium to study the uranium deposits located in Salamanca (Spain) and they plan to open the mine in 2012.

There are three main isotopes present in natural uranium, ²³⁴U (0.0055 %), ²³⁵U (0.72 %) and ²³⁸U (99.27%) with respective half-lives of 2.46 x 10⁵, 7.04 x 10⁸ and 4.47 x 10⁹ years. Given its long half-life, uranium is more chemotoxic than radiotoxic. Human activities have resulted in a number of additional uranium isotopes being released to the environment (e.g., ²³⁶U and ²³³U), as well as perturbations in natural uranium isotope ratios.

Regarding to speciation, uranium can occur either in its reduced state, U(IV), which is generally highly immobile, or in its more soluble and mobile higher state, U(VI). Usually uranium is present in oxidizing groundwater as the cationic uranyl species (UO₂⁺²). However,

⁸ Sources and Effects of Ionizing Radiation, UNSCEAR 2008 Report: Volume I: Sources - Report to the General Assembly Scientific Annexes A and B. ISBN 13: 9789211422740, 472 pp. United Nations (Ed.), United Nations Office at Vienna.

⁹ H.V. Vandenhove, C. Hurtgen, T.E. Payne. Uranium, in Radionuclides in the Environment, D. A. Atwood (Ed.), Wiley & sons, 2010. Chapter 26, 261-272.

this species usually exists only in an uncomplexed form at low pH values. Typically, the chemistry of uranyl ion in solution at higher pH values is dominated by a series of uranyl hydroxyl and uranyl carbonate complexes.

The bioavailability of uranium is dependent on its speciation or physicochemical form. The bioavailability of uranium in freshwater is influenced by a variety of physicochemical variables, including pH, humic substances, water hardness, and alkalinity. There is reasonable evidence from the literature to indicate that UO_2^{+2} and UO_2OH^+ are the major bioavailable forms of U(VI) in aquatic ecosystems. Uranyl complexation with inorganic ligands (e.g., carbonate or phosphate) and humic substances apparently reduces the bioavailability of uranium by reducing the activity of UO_2^{+2} and UO_2OH^+ . Thus, uranium mobility and bioavailability are governed by oxidation state, complexation by organic and inorganic ligands, pH, sorption by minerals including clays and hydroxides, and interactions with organic matter.

Uranium concentrations in groundwaters worldwide¹⁰ range from $< 0.001 \mu\text{g L}^{-1}$ to as high as $2600 \mu\text{g L}^{-1}$. Most groundwaters are low in uranium, typically in the range $0.1\text{-}1 \mu\text{g L}^{-1}$. Groundwaters often have higher concentrations of uranium than surface waters because of the large solid-solution ratios in aquifers and the greater influence of water-rock interactions. Concentrations in surface waters are usually low. For surface waters in Canada, uranium concentrations were in the range $0.1\text{-}4.3 \mu\text{g L}^{-1}$, but usually $< 1 \mu\text{g L}^{-1}$. Surveys of stream waters in Britain have shown concentrations mostly $< 1 \mu\text{g L}^{-1}$, although some samples with concentrations exceeding $15 \mu\text{g L}^{-1}$ have been found.

1.1.4 Thorium

Thorium is a naturally occurring radioactive member of the actinide series, usually associated with U and the rare-earth elements. Thorium is composed of 27 different isotopes with the common ones being ^{224}Th , ^{226}Th , ^{227}Th , ^{228}Th , ^{229}Th , ^{230}Th , ^{231}Th , ^{232}Th , ^{233}Th , and ^{234}Th ¹¹. Although thorium has 6 naturally occurring isotopes, none of these isotopes are stable; however, one isotope, ^{232}Th , is relatively stable, with a half-life of 14.05×10^9 years. Therefore, ^{232}Th is the only primordial isotope of thorium and makes up effectively all of natural thorium. Other particularly important isotopes of thorium are: ^{230}Th with a half-life of 75,380 years, occurs as the daughter product of ^{238}U decay, ^{229}Th with a half life of 7300 years and ^{228}Th with a half-life of 1.92 years. All of the remaining radioactive isotopes have

¹⁰ P.L. Smedley, B. Smith, C. Abesser, D. Lapworth. Uranium occurrence and behaviour in British groundwater. British Geological Survey. Groundwater systems and water quality programme, Commissioned report CR/06/050N Keyworth, Nottingham British Geological Survey, 2006.

¹¹ Z.U.W. Mahmood, C.A.R. Mohamed. Thorium, in Radionuclides in the Environment, D.A. Atwood (Ed.), Wiley & sons, 2010. Chapter 24, 247-253.

half-lives that are less than thirty days and the majority of these have half-lives that are less than ten minutes.

Thorium was formerly used commonly as for example as the light source in gas mantles, in ceramic glazes, welding rods, thermistors, catalysis, and others but most of these applications have declined due to concerns about its radioactivity. However, it is still recognized as a potential fuel for fast breeder reactors, where it is converted to fissile ^{233}U .

The intake of thorium isotopes by human being occurs mainly through animal products, cereals, vegetables and waters. Thorium is widely distributed in small amounts, with an average lithospheric concentration of 8-12 mg g⁻¹ in the earth's crust (at an average concentration of 6 mg g⁻¹ in soil). This is about two or three times as high as the concentration of uranium. However, thorium is not as soluble as uranium and is thus not as mobile as it is in the chemical environment, but does move by mechanical processes as discrete resistant mineral grains¹². Wind-blown terrestrial dust and volcanic eruptions are two important natural sources of thorium release in the air. Uranium and thorium mining, milling, and processing; phosphate fertilizer production; tin processing; phosphate rock processing; coal combustion; and industrial boilers are the primary anthropogenic sources of thorium released into the air, soil, and water.

The fate and mobility of thorium in water and soil are governed by its chemical and biological behaviors. Acidity and wet conditions enhance the solubility of thorium in soil. Thorium discharged as ThO₂ into surface waters from mining, milling, and processing will be present as suspended particles or sediment because of its low solubility. Other soluble thorium ions in water will hydrolyze at a pH above 5, forming insoluble Th(OH)₄ or hydroxyl complexes, e.g., [Th(OH)₂]⁺², [Th₂(OH)₂]⁺⁶, [Th₃(OH)₅]⁺⁷; then, the precipitates or complexes will be adsorbed by the particulate matter in water, with the result that the concentration of soluble thorium in water will be very low. In most cases, sediment resuspension and mixing may control the transportation of particle-sorbed thorium in water, but in some cases, the concentration of dissolved thorium in waters may increase due to the formation of soluble complexes with carbonate, humic materials, or other ligands in the water.

Thorium is a general health hazard and will persist long into the future as a component of residual radioactivity in the environment. Determination of thorium in nuclear wastes is important due to the long radioactive half-lives, high radiological toxicities, and criticality concerns of its isotopes. In addition, thorium determinations are necessary for waste classification purposes.

An accurate characterization of thorium interactions in the environment requires the expertise of many fields such as chemistry, biology, geochemistry, oceanography, geology,

¹² S.S. Johnson. Annual report. Virginia Minerals 37 (2) (1991) 9-16.

etc. Therefore, the development of improved analytical separation methods for thorium elements is of interest, and further progress is needed in developing analytical models, which allow for comparison and incorporation of data from these disciplines.

1.1.5 Legislation

In the case of uranium, water is one of the principal pathways for dispersal of uranium mining and mining pollutants into the environment. Water can become contaminated by surface runoff from overburden and waste rock piles, seepage through overburden and waste rock piles, and other actions where mining waste comes in contact with water. Where pyrite and other sulfidic minerals are present, acidic solutions may be generated, which increases the mobility of heavy metals and radionuclides in the ore. Since public water supplies derive their water from surface water bodies or underground sources through drilled wells, some directives/limit levels have been established. The WHO¹³ guidelines specify a provisional guideline value for uranium of 15 $\mu\text{g L}^{-1}$. The drinking water standard is 20 $\mu\text{g L}^{-1}$ of uranium in Canada¹⁴ and Australia, and 30 $\mu\text{g L}^{-1}$ in the United States¹⁵.

Regarding to thorium, as cited previously uranium and thorium mining, milling, and processing; phosphate fertilizer production; tin processing; phosphate rock processing; coal combustion; and industrial boilers are the primary anthropogenic sources of thorium released into the air, soil, and water. Although thorium pathways are well established there is no legislation on this element so far.

To date no European statutory limits have been imposed for uranium and thorium in drinking water. The European Directive (98/83/EC)¹⁶ stipulates that α -emitting radionuclides exceeding 0.1 Bq L^{-1} should be investigated to determine which corrective action, if any, is needed. There is a new proposal for a Council Directive laying down the requirements for the protection of the health of the general public with regard to radioactive substances in water intended for human consumption¹⁷ which would supersede the provisions of the Directive 98/83/EC with regard to radioactive substances. This proposal suggests the use of screening methodologies for individual radionuclides determination in replacement of gross

¹³ WHO (World Health Organization), Guidelines for drinking water quality. 3rd edition, World Health Organization, Geneva, Switzerland, 2004.

¹⁴ Health Canada. Guidelines for Canadian drinking water quality: Summary table, 2008.

¹⁵ USEPA (United States Environmental Protection Agency). A regulator's guide to the management of radioactive residuals from drinking water treatment technologies. Office of water (4606M), EPA 816-R-05-004, 2005.

¹⁶ European directive 98/83/EC. Related with drinking water quality intended for human consumption. European Directive, Brussels, Belgium, 1998, Vol. L330, p. 32.

¹⁷ Proposal for a Council Directive laying down the requirements for the protection of the health of the general public with regard to radioactive substances in water intended for human consumption. Interinstitutional File: 2011/0170 (NLE).

alpha activity or gross beta activity screening and if one of the activity concentrations exceeds 20% of its reference concentration, an analysis of additional radionuclides should be required. Therefore, accurate, precise, reliable and rapid analytical methods with low detection limits are needed to determine the concentrations of radionuclides in environmental samples, especially of naturally occurring long lived radionuclides, such as uranium and thorium.

1.2 Laboratory automation

Since the beginnings of automation of analytical methods, various different flow techniques have been developed and used for analytical or monitoring applications. They have gained importance for clinical, industrial and environmental purposes as they allow highly reproducible fast determinations. Automation and miniaturization of solution-based analysis are essential to make them fast and efficient for routine and research tasks¹⁸.

Sample preparation accounts for over 60-80% of the total analysis time and normally is the main contributor to analytical uncertainty. Thus, automation of sample preparation is of great value in order to maximize throughput and minimize costs, time, and analyst risks due to chemicals exposure. In this context, on-line coupling of solid phase extraction (SPE) to different detectors represents the automation milestone, as the overall analytical protocol can be fully mechanized.

Ideally, analytical equipment should be versatile, capable of accommodating a wide variety of assays without the need for system reconfiguration, and compatible with a wide range of detectors. Among the benefits of automation of analytical procedures, the increase of sample frequency, minimization of sample contamination or alteration, miniaturization of the analytical system, and lower reagent and sample consumption, implying less personal and consumable costs should be highlighted.

A comprehensive review on flow techniques has been submitted for publication. This review entitled "Laboratory automation" is enclosed at the end of this chapter. However, the flow techniques which have been used in this thesis are described in more detail below.

1.2.1 Multisyringe flow injection analysis – MSFIA

Multisyringe flow injection analysis¹⁹⁻²¹ (MSFIA) was firstly described in 1999 by our group and developed in collaboration with Crison (Barcelona, Spain), as a novel multichannel technique combining the multichannel operation and high injection throughput of Flow Injection Analysis (FIA) with the robustness and the versatility of Sequential Injection Analysis (SIA). By use of parallel moving syringes as liquid drivers, it overcomes the shortcomings of peristaltic pumping such as pulsation, required recalibration of flow rates

¹⁸ M. Trojanowicz. *Advances in flow analysis*, Wiley-VHC, Weinheim, Germany, 2008.

¹⁹ V. Cerdà, J.M. Estela, R. Forteza, A. Cladera, E. Becerra, P. Altimira, P. Sitjar. *Flow techniques in water analysis*. *Talanta* 50 (1999) 695-705.

²⁰ M. Miró, V. Cerdà, J.M. Estela. Multisyringe flow injection analysis: characterization and applications. *Trends Anal. Chem.* 21 (2002) 199-210.

²¹ V. Cerdà, R. Forteza, J.M. Estela. Potential of multisyringe flow-based multicommutated systems. *Anal. Chim. Acta* 600 (2007) 35-45.

and limitations regarding applicable reagents. Flow rates and propelled volumes are precisely known and defined by software-based remote control of the multisyringe device, as in SIA. Moreover, by implementation of the multicommutation concept, another shortcoming of FIA was overcome, since liquids are delivered to the system only when required and so the reagents and sample consumption are low. Thus, MSFIA is an ideal multichannel technique for challenging analytical procedures, which require high and precise flow rates, and high pressure stability such as those with sorbent columns implementation²², enabling at the same time, the handling of aggressive and volatile solutions. The only disadvantage of MSFIA in front of other flow techniques is the periodical syringe refilling which causes a lower injection frequency than using a FIA approach.

Recent trends in the development of MSFIA systems involve its hyphenation with Lab-on-Valve²³⁻²⁵, multipumping flow systems²⁶ and low pressure chromatography using monolithic columns²⁷⁻²⁹. This shows its versatility and ease of implementation.

A more detailed technical description of the MSFIA module is given in Chapter 3, section 3.1.1.

1.2.2 Multipumping flow systems - MPFS

Multipumping flow systems^{30,31} (MPFS) are based on using solenoid micropumps for propelling liquids. These low cost devices are responsible for both sample-reagent

²² M.I.G.S. Almeida, J.M. Estela, V. Cerdà. Multisyringe flow Injection potentialities for hyphenation with different types of separation techniques. *Anal. Letters* 44 (2011) 360-373.

²³ J.B. Quintana, M. Miró, J.M. Estela, V. Cerdà. Automated on-line renewable solid-phase extraction-liquid chromatography exploiting multisyringe flow injection-bead injection lab-on-valve analysis. *Anal. Chem.* 78 (2006) 2832-2840.

²⁴ X. Long, M. Miró, E.H. Hansen, J.M. Estela, V. Cerdà. Hyphenating multisyringe flow injection lab-on-valve analysis with atomic fluorescence spectrometry for on-line bead injection preconcentration and determination of trace levels of hydride-forming elements in environmental samples. *Anal. Chem.* 78 (2006) 8290-8298.

²⁵ H.M. Oliveira, M.A. Segundo, J.L.F.C. Lima, M. Miró, V. Cerdà. On-line renewable solid-phase extraction hyphenated to liquid chromatography for the determination of UV filters using bead injection and multisyringe-lab-on-valve approach. *J Chromatogr. A* 1217 (2010) 3575-3582.

²⁶ Y. Fajardo, L. Ferrer, E. Gómez, F. Garcías, M. Casas, V. Cerdà. Development of an automatic method for americium and plutonium separation and preconcentration using a multisyringe flow injection analysis multipumping flow system. *Anal. Chem.* 80 (2008) 195-202.

²⁷ H.M. Oliveira, M.A. Segundo, J.L.F.C. Lima, V. Cerdà. Multisyringe flow injection system for solid-phase extraction coupled to liquid chromatography using monolithic column for screening of phenolic pollutants. *Talanta* 77 (2009) 1466-1472.

²⁸ F. Maya, J.M. Estela, V. Cerdà. Interfacing on-line solid phase extraction with monolithic column multisyringe chromatography and chemiluminescence detection: An effective tool for fast, sensitive and selective determination of thiazide diuretics. *Talanta* 80 (2010) 1333-1340.

²⁹ F. Maya, J. M. Estela, V. Cerdà. Multisyringe ion chromatography with chemiluminescence detection for the determination of oxalate in beer and urine samples. *Microchim. Acta* 173 (2011) 33-41.

introduction and manifold commutation. Minimal reagent consumption is achieved, since each micropump is operated individually in inserting the solutions. In comparison with other flow techniques, the pulsed flow of the micropumps is better and faster at homogenizing the reaction zone³², which leads to higher analyte peaks. Main features to be highlighted are the simplicity and very low costs of the controlling circuits, favouring economic, portable and miniaturised flow analysers^{33,34}, which facilitate field measurements. Further advantages of MPFS are a high versatility and flexibility of the flow system networking, especially in combination with multicommutation selection valves (MCSV). However, some disadvantages of the micropumps are the susceptibility to blockage by particles and to backpressure, requiring recalibration of the volume dispensed.

A more detailed technical description of the MPFS is given in Chapter 3, section 3.1.2.

1.2.3 Lab-on-Valve – LOV

The recently proposed lab-on-valve^{35,36} (LOV) brings to flow-based analysis the third generation, which significantly facilitates integration of various analytical units in the valve and provides great potential for miniaturization of the entire instrumentation.

Precise volumes of sample and reagents are stacked in a holding coil by sequential aspiration from the microfluidic device mounted atop a rotary selection valve and propelled afterwards by flow reversal. It is shown that sample handling in the sequential injection mode, which employs forward, reversed and stopped flow, can be programmed to accommodate a wide variety of assays, such as solution metering, mixing, dilution, incubation and monitoring. In addition to compactness, another advantage of these “lab-on-valve” systems is the permanent rigid position of the sample processing channels that ensures repeatability of microfluidic manipulations. This provides proven robustness and reliability of operation, and makes the microfluidic system compatible with real life samples and peripheral instruments.

³⁰ R.A.S. Lapa, J.L.F.C. Lima, B.F. Reis, J.L.M. Santos, E.A.G. Zagatto. Multi-pumping in flow analysis: concepts, instrumentation, potentialities. *Anal. Chim. Acta* 466 (2002) 125-132.

³¹ J.L.F.C. Lima, J.L.M. Santos, A.C.B. Dias, M.F.T. Ribeiro, E.A.G. Zagatto. Multi-pumping flow systems: an automation tool. *Talanta* 64 (2004) 1091-1098.

³² C. Pons, R. Forteza, A.O.S.S. Rangel, V. Cerdà. The application of multicommutated flow techniques to the determination of iron. *Trends Anal. Chem.* 25 (2006) 583-588.

³³ B. Horstkotte, C.M. Duarte, V. Cerdà. A miniature and field-applicable multipumping flow analyzer for ammonium monitoring in seawater with fluorescence detection. *Talanta* 85 (2011) 380-385.

³⁴ B. Horstkotte, C.M. Duarte, V. Cerdà. Multipumping flow systems devoid of computer control for process and environmental monitoring. *Intern. J. Environ. Anal. Chem.* (2011). DOI: 10.1080/03067319.2010.548601.

³⁵ J. Ruzicka. Lab-on-valve: universal microflow analyzer based on sequential and bead injection. *Analyst* 125 (2000) 1053-1060.

³⁶ J. Wang, E. H. Hansen. Sequential injection lab-on-valve: the third generation of flow injection analysis. *Trends Anal. Chem.* 22 (2003) 225-231.

It is noteworthy that LOV-based techniques have not only been extensively employed in homogeneous solution-based assays, but have also shown promise in heterogeneous assays because flexible fluid manipulation is also suitable for delivering beads in flow-based manifolds, i.e. precise fluid manipulation by the LOV system and the channel configuration also make it a powerful platform for bead injection (BI)^{37,38}. In combination with the renewable surface concept, BI has been widely exploited for separation and preconcentration of analytes in the presence of complex matrix components. Most importantly, the automated transport of solid materials in such a system allows their renewal at will and thus provides measurement, packing and perfusion of beads with samples and reagents with a high degree of repeatability.

Furthermore, being operated in a closed system, LOV systems are characterized by low consumption of sample and reagent, reduced analysis time, high reproducibility and minimal sample contamination. Shortcomings of LOV are quite similar to those of classical SIA, such as a worse zone penetration and longer time of analysis than in FIA due to the use of wider tubes, the refilling of the syringe and the sequential injection mode. Another disadvantage is the impossibility of confluence mixing. Some of these disadvantages are overcome by coupling it to MSFIA as can be seen in some of the developed methods.

Summarizing, true advantages of using microfluidics are the compactness, the automation of all the steps of the experimental protocol and, last but not least, the integration of all manifold components into a permanent rigid structure that enhances the repeatability of sample processing operations.

A more detailed technical description of the LOV is given in Chapter 3, section 3.1.3.

³⁷ Y. Yu, Y. Jiang, M. Chen, J. Wang. Lan-on-valve in the miniaturization of analytical systems and sample processing for metal analysis. *Trends Anal. Chem.* 30 (2011) 1649-1658.

³⁸ S.S.M.P. Vidigal, I.V. Tóth, A.S.S. Rangel. Exploiting the bead injection LOV approach to carry out spectrophotometric assays in wine: Application to the determination of iron. *Talanta* 84 (2011) 1298-1303.

1.3 Detectors

In this section, the basis of the detection techniques used in the developed methods integrated in this thesis are presented. Spectrophotometric detection was used for total determination (screening methods) and finally, an ICP-MS method is proposed for isotopic analysis of uranium and thorium.

1.3.1 Spectrophotometric detection

In three of the proposed methods spectrophotometric detection has been chosen to the development of simple and inexpensive systems easily adaptable to field measurements. Spectrophotometry is always an acceptable alternative method for total element determination (e.g. either total-uranium or total-thorium determination), due to its robustness and acceptable precision and accuracy, associated with its lower cost compared with other techniques. Moreover, it is possible to automate these methods fully and to make them portable. The critical point against the use of spectrophotometry for determination of uranium and thorium is generally associated with low sensitivity and selectivity of the spectrophotometric determinations. These limitations can be solved by using selective extraction materials and a long path-length liquid core waveguide capillary cell (LWCC) to enhance the sensitivity of the detection system. The emerging potential of LWCCs for the determination of chemical species at low concentrations enhances the capability to investigate environmental processes and monitor environmental systems. Taking into account that the absorbance is directly proportional to the path length, as can be seen at the Lambert-Beer's law described below, an improvement of several orders of magnitude in the signal regarding to a 1 cm path length cell can be accomplished.

$$A = \epsilon \times b \times c$$

Where,

- A represents the absorbance,
- ϵ molar absorptivity,
- b optical path length,
- c analyte concentration.

It is expected in near future that new Directives will define reference values for single radionuclides. Since isotopic analyses usually require extensive protocols to separate the

single radionuclides, spectrophotometric methods used as screening tools will be very handy, enabling fast, sensitive and robust analyses.

1.3.2 Inductively Coupled Plasma Mass Spectrometry - ICP-MS

ICP-MS is the most frequently used mass spectrometric technique for the determination of elements and isotope ratios in the trace and ultratrace concentration range. In recent years, it has also increasingly been used for determination of radionuclides in environmental, biological and waste samples^{39,40}. In contrast to conventional inorganic solid mass spectrometric techniques, ICP-MS allows a simple sample introduction in an ion source operating at atmospheric pressure and an easy quantification procedure using aqueous standard solutions. In ICP-MS, the chemical compounds contained in the sample solution are decomposed into their atomic constituents in an inductively coupled argon plasma at a temperature of 6000-8000 K, this high temperature ensures a high degree of ionization (> 90% for most elements) with a low fraction of multiply charged ions. The positively charged ions are extracted from the inductively coupled plasma into a high vacuum of the mass spectrometer via an interface. The extracted ions are then separated by mass filters of either quadrupole type, time of flight or combination of magnetic and electrostatic sector, and finally measured by an ion detector. This way the number of atoms of the radionuclide of interest is directly measured. At present both MC-ICP-MS and Multi-collector thermal ionization mass spectrometry (MC-TIMS) instruments are considered the ultimate tools for isotope ratio measurement of the longer lived U and Th isotopes⁴¹. TIMS instruments show the best ion beam stability and better abundance sensitivity due to the lower spread in ion energy than ICP-MS instruments. However, for thorium in particular, ICP-MS is better than TIMS due to the low ionization efficiency at the TIMS filament. Another advantage with ICP-MS instruments is that other isotope than what is intended to be measured may be used to correct for the mass bias (in this thesis, bismuth was used as internal standard to improve the precision). ICP-MS is an increasingly important tool for the determination of longer-lived radionuclides. In general, the long-lived radioisotopes are best determined by mass spectrometric methods, while the short-lived ones are preferably determined by radiometric methods. Relative to radiometric detection techniques, ICP-MS can potentially offer lower detection limits for longer-lived radioisotopes, shorter analysis times, and more

³⁹ X. Hou, P. Roos. Critical comparison of radiometric and mass spectrometric methods for the determination of radionuclides in environmental, biological and nuclear waste samples. *Anal. Chim. Acta* 608 (2008) 105-139.

⁴⁰ D. Larivière, V.F. Taylor, R.D. Evans, R.J. Cornett. Radionuclide determination in environmental samples by inductively coupled plasma mass spectrometry. *Spectrochim. Acta Part B* 61 (2006) 877-904.

⁴¹ J.S. Becker. Mass spectrometry of long-lived radionuclides. *Spectrochim. Acta Part B* 58 (2003) 1757-1784.

straightforward analytical procedures. Main advantages of ICP-MS are speed and sensitivity, with the capability of determining all the actinide elements within a minute, at concentrations as low as 1 ng L^{-1} in liquid samples. In addition, there is no need to separate the elements one from another, as there is in alpha-spectrometry, because this is achieved by the mass spectrometer, hence the number of sample pretreatment stages and the time per analysis can be greatly reduced. Thus, ICP-MS has been widely used for the determination of isotopes of uranium, thorium, plutonium, strontium, americium, radium, lead, technetium, palladium, neptunium, curium and iodine in environmental and waste samples.

The major obstacle with alpha spectrometry for U and Th isotopes determination in environmental samples are long counting times (days–weeks) and a limited precision due to the counting statistics. Due to the low specific activity of the long-lived ^{238}U and ^{232}Th isotopes (12.3 and 4 Bq mg^{-1} , respectively), long counting times are necessary in order to obtain sufficiently good counting statistics. In addition, careful separations from the sample matrix are necessary in order to obtain thin counting sources, which are required for good energy resolution. Although matrix suppression of the signal also occurs in mass spectrometry, counting of the ions instead of their emitted radiation makes mass spectrometric analysis of the long-lived ^{238}U and ^{232}Th around six orders of magnitude more sensitive than the radiometric methods. Therefore, ICP-MS provides a rapid and sensitive technique for the determination of these elements. Nevertheless, high levels of sample matrix can produce interferences in the plasma which result in a suppression of analyte ionization, or block the nebulizer or torch due to the deposition of dissolved solids coming out of solution. An important consideration is the concentration of total dissolved solids (TDS) present in the solution when it is analyzed. As a general rule, this concentration should not exceed 0.1%. This necessitates some form of sample pretreatment. Sample dilution will decrease the matrix effects but will also decrease the U and Th concentrations. SPE separates the analytes from the matrix sample without reducing the analyte concentration, and has the advantage, when coupled on-line, of requiring only a small sample volume. Flow techniques represent a versatile fluid handling methodology that can be used for automating chemical separations. Continuous FIA separation/preconcentration techniques with ICP-MS have been described for analysis of U and Th in environmental matrixes⁴²⁻⁴⁴.

⁴² J. H. Aldstadt, J. M. Kuo, L. L. Smith, M. D. Erickson. Determination of uranium by flow injection inductively coupled plasma mass spectrometry. *Anal. Chim. Acta* 319 (1996) 135-143.

⁴³ J. B. Truscott, L. Bromley, P. Jones, E. H. Evans, J. Turner, B. Fairman. Determination of natural uranium and thorium in environmental samples by ETV-ICP-MS after matrix removal by on-line solid phase extraction. *J. Anal. At. Spectrom.* 14 (1999) 627-631.

1.4 Solid phase extraction-SPE

Direct determination of uranium and thorium by instrumental techniques including ICP-MS is still difficult because of insufficient sensitivity, lack of selectivity, presence of complex matrix, poor precision and accuracy. To solve these problems, enrichment and separation techniques have been used in the analytical chemistry laboratories for uranium and thorium determinations. SPE is one of the most important preconcentration-separation procedures for trace heavy-metals ions, due to its simplicity and limited usage of the organic solvents. Among many others, ion exchange and extraction chromatography are very popular methods due to their applicability to both preconcentration and separation. Extraction chromatography combines the selectivity of liquid-liquid extraction with the rapidity of chromatographic methods. The separation of the radionuclides is based on the distribution of the cations of interest between an organic and an aqueous phase. The extractant is adsorbed on the surface of an inert support and corresponds to the organic, stationary phase (Fig. 1.4). The utilized support has to be inert with respect to chemical reactions with the organic phase and the retained cations. It also has to be stable against mechanical influences and must have a large specific surface. In addition the support should be spherical in order to allow optimum packing. The extractant, which is determining the capacity of the resin, has to have a high selectivity and needs to be chemically and physically stable.

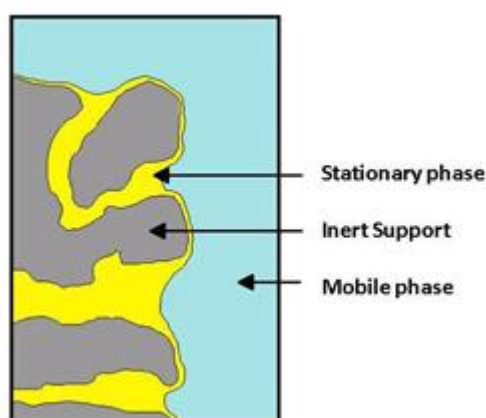

Figure 1.4 Scheme of a resin particle.

⁴⁴ J. B. Truscott, P. Jones, B. E. Fairman, E. H. Evans. Determination of actinide elements at femtogram per gram levels in environmental samples by on-line solid phase extraction and sector field-inductively coupled plasma-mass spectrometry. *Anal. Chim. Acta* 433 (2001) 245-253.

The general procedure consists of: first conditioning of the resin, then the sample is loaded, after that a rinsing or washing step is carried out in order to eliminate the possible interferences which have been also retained on the SPE material and finally the isolated and sometimes pre-concentrated analytes are eluted (Fig. 1.5).

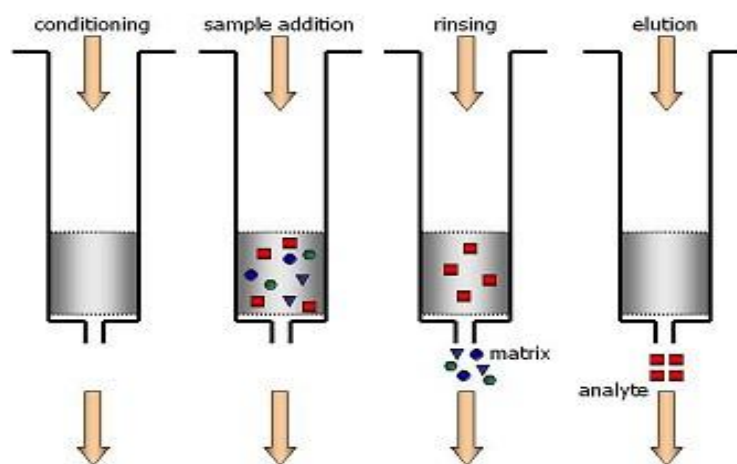

Figure 1.5 Schematic depiction of the extraction and pre-concentration processes in SPE.

Some advantages derived from using these materials are the substantial minimization of sample and reagents consumption, as well as the ease of the analytical procedure. Moreover, pre-concentration improves the detection limits, increases the sensitivity and enhances the accuracy of the results. Analytical expectations can be outranged if the total automation of the methodology is achieved. Horwitz et al. have developed several types of extraction chromatographic resins that can be used for enrichment and separation of uranium and thorium^{45,46}.

So it is well known that uranium and tetravalent actinide specific resin UTEVA[®] and transuranium specific resin TRU are very applicable for separation of U and Th from various types of samples^{2,47-52}. The implementation of highly selective chromatographic columns to

⁴⁵ E. P. Horwitz, M. L. Dietz, R. Chiarizia, H. Diamond. Separation and pre-concentration of uranium from acidic media by extraction chromatography. *Anal. Chim. Acta* 266 (1992) 25-37.

⁴⁶ E. P. Horwitz, R. Chiarizia, M. L. Dietz, H. Diamond. Separation and pre-concentration of actinides from acidic media by extraction chromatography. *Anal. Chim. Acta* 281 (1993) 361-372.

⁴⁷ C. Pin, J. F. S. Zalduegui. Sequential separation of light rare-earth elements, thorium and uranium by miniaturized extraction chromatography: Application to isotopic analyses of silicate rocks. *Anal. Chim. Acta* 339 (1997) 79-89.

⁴⁸ R. Pilviö, M. Bickel. Separation of actinides from a bone ash matrix with extraction chromatography. *J. Alloys Comp.* 271-273 (1998) 49-53.

⁴⁹ H. E. Carter, P. Warwick, J. Cobb, G. Longworth. Determination of uranium and thorium in geological materials using extraction chromatography. *Analyst* 124 (1999) 271-274.

⁵⁰ J. Wang, I. Chen, J. Chiu. Sequential isotopic determination of plutonium, thorium, americium, strontium and uranium in environmental and bioassay samples. *Appl. Rad. Isot.* 61 (2004) 299-305.

flow based methodologies allowed the automation of many analytical methods. Nowadays, there are specific resins for the determination of Ra, Ni, Pb, Th, U, Np, Pu, Am, Cm, Sr, Tc, ^3H y Fe between others, which have been included in automated separation protocols.

For example, TRU resin extracts not only tetra- and hexa-valent ions but also trivalent ions from HNO_3 solutions of high concentration ($>1 \text{ mol L}^{-1}$). However, TRU resin needs a relatively large amount of stripping solution and/or stripping agent to elute tetra- and hexavalent actinide elements. TEVA[®] resin extracts tetravalent actinide elements from HNO_3 solutions of high concentration ($>1 \text{ mol L}^{-1}$) and elutes them with a small amount of stripping solution. However, hexavalent uranium is hardly extracted from HNO_3 solutions with TEVA[®] resin. UTEVA[®] resin extracts tetra- and hexa-valent actinides from HNO_3 solutions of high concentration ($>1 \text{ mol L}^{-1}$) simultaneously and elutes them with a small amount of stripping solution.

⁵¹ A. Fujiwara, Y. Kameo, A. Hoshi, T. Haraga, M. Nakashima. Application of extraction chromatography to the separation of thorium and uranium dissolved in a solution of high salt concentration. *J. Chromatogr. A* 1140 (2007) 163-167.

⁵² H. Michel, D. Levent, V. Barci, G. Barci-Funel, C. Hurel. Soil and sediment sample analysis for the sequential determination of natural and anthropogenic radionuclides. *Talanta* 74 (2008) 1527-1533.

1.5 Objectives

Taking into account the occurrence, the characteristics of uranium and thorium in the environment as well as the evolution of the directives which stipulate the limit values of radioactive materials in water samples, the general objective of this thesis is the development of new automated, accurate, precise, reliable and rapid analytical systems for monitoring of uranium and thorium in environmental samples, exploiting flow analysis techniques. According with current trends, we would like to implement mainly multicommutated flow techniques (LOV, MSFIA and MPFS) in order to achieve sensitive and selective analytical methodologies based on SPE and spectrophotometric or ICP-MS detection allowing total and isotopic analysis of uranium and thorium at trace levels, respectively.

More specifically the following objectives were proposed:

1. Selection of low cost instruments and materials for the development of inexpensive methods for thorium and uranium determination which can be used for field measurements, i.e. development of portable uranium and thorium analyzers.
2. Reduction of the time of analysis, that is to say, to increase the sample injection throughput and minimization of handling of samples by the analyst. This will be useful for monitoring purposes and in case of a nuclear accident to become acquainted of the seriousness of it as soon as possible reducing at the same risks during the analysis.
3. Minimization of reagents consumption and so the waste generation. Reducing this way the environmental impact per analysis.
4. Development of new methods based on multicommutated flow analysis techniques with high degree of automation, including the separation and preconcentration pretreatment stages and the on-line detection. Reaching a total automation degree, as for example development of autonomous smart systems.
5. Development of methods of screening for fast uranium and thorium determination at trace levels.
6. Development of fast, simple and fully automated systems capable of isotopic analysis of uranium and thorium in environmental samples.

This work was incorporated into the projects of the National Plan for Science and Chemical Technology CTQ2007-64331 and CTQ2010-15541 entitled "Development of automated methods of analysis. Application to environmental monitoring plans" supported by the Spain's Ministry of Science and Innovation. It contributed specially to the part of monitoring of radioactive elements in samples of environmental interest.

1.6 Original paper

This review “Laboratory Automation by flow techniques” by V. Cerdà, J. Avivar and A. Cerdà has been accepted for publication as invited manuscript in the journal Pure and Applied Chemistry (IUPAC) (impact factor: 2.128 year 2010).

Chapter 2

State of the art of automation in radiochemical analysis

In this chapter, the state of the art of automation regarding radionuclide determinations in environmental samples is reviewed.

2.1 Introduction

Since radionuclides activity concentrations in environmental samples are very low, and the presence of other interfering elements and radionuclides, preconcentration and radiochemical separation are often unavoidable. Most of the assays are carried out manually, which make them expensive, tedious and time consuming. Some attempts have been carried out with the aim of automating these techniques by the use of flow techniques, but most of these methods have only been applied to samples with high radioisotopes content from nuclear power stations. In other words, there are scarce automated methods for radioisotopes determination at environmental levels in the bibliography, despite the existence of treaties and directives which establish the need of environmental monitoring programs.

The European Atomic Energy Community (EURATOM) was established in 1957 in the so called "Treaties of Rome" with the main objective of contributing to the formation and development of Europe's nuclear industries, so that all the Member States can benefit from the development of atomic energy, and to ensure security of supply. At the same time, the Treaty guarantees high safety standards for the public and prevents nuclear materials intended principally for civilian use from being diverted to military use. Particularly, the articles 35 and 36 of the Euratom Treaty require that each Member State shall establish the facilities necessary to carry out continuous monitoring of the levels of radioactivity in air, water and soil and to ensure compliance with the basic safety standards. The Spanish Nuclear Security Council (Consejo de Seguridad Nuclear "CSN") was created in 1980¹ as the only body responsible of the nuclear safety and radiation protection in Spain. Thus, the CSN is responsible of the monitoring and control of the radioactivity levels in the whole Spanish territory. In 1985 the Spanish government signed the treaties that constituted the European Community, including the EURATOM, and became part of the European Union the year after. From that moment, the rules imposed by the EURATOM regarding to radioactive waste, radiation protection and nuclear safety become mandatory for Spain as a member of the EU. Moreover, the Chernobil accident in April 1986 highlighted the need to establish a regular environmental monitoring program, so the Spanish government decided to develop a radiation monitoring network, the REVIRA network. Actually, this network consists of two networks, the automatic stations network (Red de Estaciones Automáticas "REA") which is connected to the CSN and provides continuously real-time data (gamma radiation, I-131, radon, alpha and beta activity concentration) being a powerful warning tool in case of a radiological incident, and the sampling stations network (Red de Estaciones de

¹ Ley 15/1980, de 22 abril, de creación del CSN.

Muestreo “REM”) which enables the determination of radionuclides in the laboratory in different samples of environmental interest such as dust particles in air, soil, water, milk and food. Nowadays this network comprises 25 stations², 24 in Spanish territory and one in Portugal.

Thus, our group started participating at the REVIRA network in 1991. In addition to the systematic monitoring of a number of radioisotopes, resources and experience with classical radiochemical methodologies have been employed in a parallel research line that has led to the implementation of some automated methods based on multicommutated flow techniques for the determination of isotopes of Ra, Y, Sr, Am, Pu, U and Th. Some of these automated methods are easy portable enabling in-situ measurements, thus reducing the time of exposure of the analyst to problematic samples. Other methods are just partially automated, although the steps susceptible to automation, i.e. the sample pretreatment steps, are the most laborious, with a higher degree of manipulation by the analyst, the highest reagent consumption and the longest execution times. Thus, by automating radiochemical separations, an analysis which could take days is reduced to hours. Furthermore, using multicommutated techniques (i.e. SIA, LOV, MPFS and MSFIA), minimal reagents consumption is achieved, since they are dispensed to the system only when needed, resulting in greener and more economic automated systems.

More detailed information can be found in a comprehensive review entitled “Automation of radiochemical analysis by applying flow techniques to environmental samples”, attached to this chapter. In this article, the state of the art of automation in the radiochemical field is reviewed. Also, a critical comparison of automatic protocols exploiting various generations of flow techniques with a variety of detection systems to determine radioisotopes in samples of environmental interest can be found in it.

² REVIRA: Red de Vigilancia Radiológica Ambiental, CSN, 2009. Legal deposit M 17.108-2005.

2.2 Original paper

The review “Automation of radiochemical analysis by applying flow techniques to environmental samples” by Y. Fajardo, J. Avivar, L. Ferrer, E. Gómez, M. Casas and V. Cerdà published in *Trends in Analytical Chemistry* 29 (2010) 1399-1408, is attached below. *Trends in Analytical Chemistry* (impact factor: 6.602 year 2010) is located at the first quartile of the journals of the Analytical Chemistry area.

Chapter 3

Experimental section: instrumentation and common materials

In this chapter, the software, the instrumentation (including detection systems and flow instrumentation), and the multivariate optimization methodology used are presented.

3.1 Flow instrumentation

A multisyringe pump module Bu4S and a rotatory autosampler (Crison Instruments S.A., Barcelona, Spain) were used in all the developed methods. The autosampler used was equipped with a 45-position turntable for 15 mL tubes. A valve module VA1+1 (Crison Instruments) was used in three of the methods presented in this thesis. A six-port injection valve (IV) MultiBurette 4S (Crison Instruments) was used in the last developed method. Micropumps (BIO-Chem Valve, NJ, USA), were used in the first developed method presented in this thesis.

The instruments were connected in series to a personal computer for remote operational control via the serial RS232C interface and accomplished by the software AutoAnalysis as described in section 3.3. The instrumentation used in the proposed methods is described in detail below.

3.1.1 Multisyringe burette

The multisyringe burette¹ can be equipped with up to four syringes, which are used as liquid drivers (Fig.3.1). Each syringe has a three-way solenoid valve (N-Research, Caldwell, NJ, USA) at the head, which facilitates the application of multicommutation schemes. Pistons are mounted on a common steel bar driven by a single step motor (40000 steps). Thus, all pistons are moved simultaneously and unidirectional for either liquid delivering (dispense) or aspirating (pick up).



Figure 3.1 Frontal view of the Multisyringe burette.

¹ V. Cerdà, J.M. Estela, R. Forteza, A. Cladera, E. Becerra, P. Altimira, P. Sitjar. Flow techniques in water analysis. *Talanta* 50 (1999) 695-705.

The step motor showed a speed range of 1024-20 s for total displacement, corresponding to 40000 steps. Thus, the multisyringe module allowed precise handling of microliters and a wide flow rate range ($0.057\text{-}30\text{ mL min}^{-1}$, depending on the syringe volume 1-10 mL). Syringes of 0.5, 1, 2.5, 5, 10 and 25 mL are available, enabling a wide flow rate range and a great combination. High chemical robustness is provided by the use of resistant polymers poly(ethylene-co-tetrafluoroethylene) (ETFE) (head valves) and poly(tetrafluoroethylene) (PTFE) (piston heads, poppet flaps).

Solenoids valves located at the heads of the syringes (on: to the system; off: to the reservoir) allow four kinds of liquid displacement: On-dispense, Off-dispense, On-pick-up and Off-pick-up (Fig.3.2).

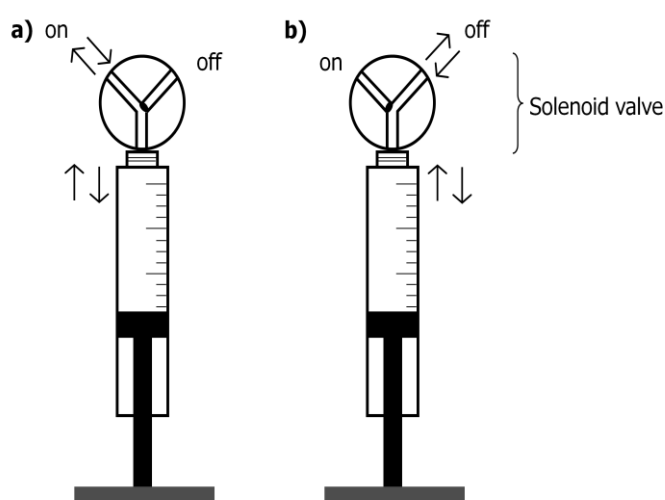

Figure 3.2 Schematic depiction of the solenoid valves placed at the head of each syringe. a) Activated solenoid: “on” position and b) Deactivated solenoid: “off” position.

Four backside ports (V5-V8, Fig. 3.3) enable the power of additional external multicommutation valves, micropumps or other instruments either directly or via a relay allowing remote software control (ICP-MS). This amplifies the possibilities to construct sophisticated flow networks. External solenoid valves are commonly used to drive the liquids in the proposed systems (Fig. 3.4). Each port provides 12 V with a maximal current of 0.5 A, enabling the connection of up to three MCSV to each port.



Figure 3.3 Backside connections of the multisyringe burette.



Figure 3.4 External solenoid valve.

3.1.2 Multipumping flow system

A MPFS² set-up was used at the first developed method and consisted of three solenoid micropumps (BIO-Chem Valve, NJ, USA) with stroke volumes of 20 μL (M1 and M2) and 8 μL (M3). A micropump (Fig. 3.5) is a solenoid operated device designed to provide a discrete dispensed volume of fluid. The flow path is isolated from the operating mechanism by a flexible diaphragm. When the solenoid is energized, the diaphragm is retracted creating a partial vacuum within the pump body. This pulls liquid through the inlet check valve (A) and

² R. A. S. Lapa, J. L. F. C. Lima, B. F. Reis, J. L. M. Santos, E. A. G. Zagatto. Multi-pumping in flow analysis: concepts, instrumentation, potentialities. *Anal. Chim. Acta* 466 (2002) 125–132.

simultaneously closes the outlet check valve (B). When the solenoid is de-energized a spring pushes the diaphragm down, expelling a discrete volume of liquid through check valve B while simultaneously closing check valve A. Micropumps require a complete on-off cycle for each discrete dispense. Repeatedly cycling the solenoid creates a pulsed flow. Each micropump allows injection of a specific volume of reagent or sample, varying the number of pulses. The flow rate is controlled according to the frequency and volume dispensed in each pulse. The body of the micropumps is made of steel at the top and teflon at the bottom where is the pumping system (diaphragm). Micropumps when activated use an internal source of 12 V. A schematic depiction of the controller system designed and created by our group and commercialized by Sciware S.L.³ (Palma de Mallorca, Spain) is shown in Fig. 3.6. This modul was controlled through the interface RS232.

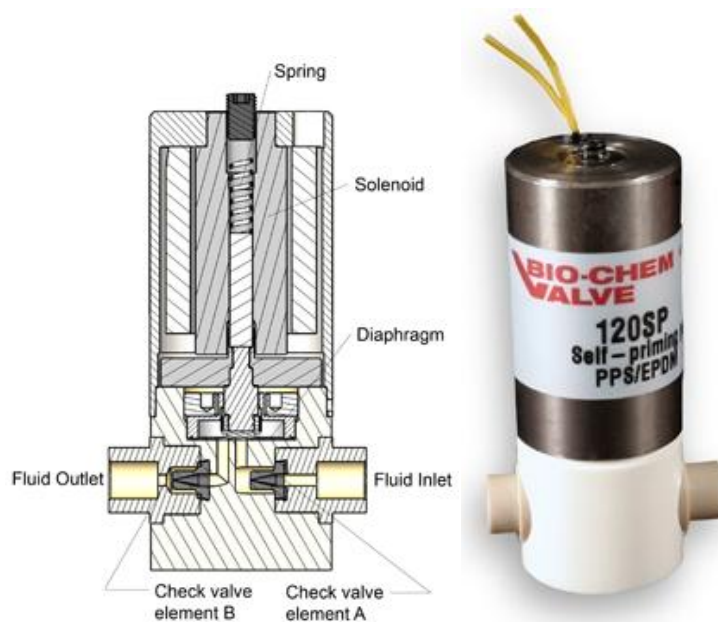

Figure 3.5 Image and scheme of a micropump.

³ www.sciware.com.

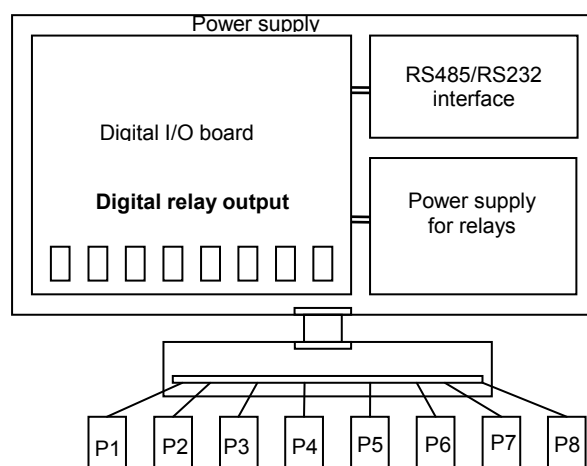

Figure 3.6 Schematic depiction of the controller system of micropumps.

3.1.3 Lab-on-valve (LOV)

In the Lab-on-Valve^{4,5} methodology, sample, reagents and beads manipulation is carried out in a sequential mode, allowing direct and reversed flow. The LOV microconduits are specially designed for each system and were fabricated from methacrylate as a monolithic structure encompassing either eight or six integrated microchannels (1.5 mm i.d./16.0 mm length, excepting the bead column channel made of 3.2 mm i.d.), and commercialized by Sciware. These were mounted atop of a multiposition selection valve (SV) (Fig. 3.7a). All of them of low pressure design and made of chemical resistant polymers PEEK (stator) and PTFE (rotor) (Fig. 3.7b).

The central port of the integrated LOV sample processing unit, connected to a syringe of the MSFIA module, via a holding coil, is made to address the peripheral ports of the unit, for sequential aspiration of the various constituents for the BI process, via the central communication channel (CC) in the selection valve (see Fig. 3.7b). One of the LOV channels (port 1) serves as microcolumn position for the renewable beads. This column is filled in with an appropriate amount of resin (see Fig. 3.7a). To contain the sorbent within the cavity of the LOV module and prevent them from escaping, the outlet of the column was furnished with a glass fibre prefilter (Millipore) retaining the beads while allowing the solution to flow freely (Fig. 3.8).

⁴ J. Ruzicka. Lab-on-valve: universal microflow analyzer based on sequential and bead injection. *Analyst* 125 (2000) 1053-1060.

⁵ J. Wang, E. H. Hansen. Sequential injection lab-on-valve: the third generation of flow injection analysis. *Trends Anal. Chem.* 22 (2003) 225-231.

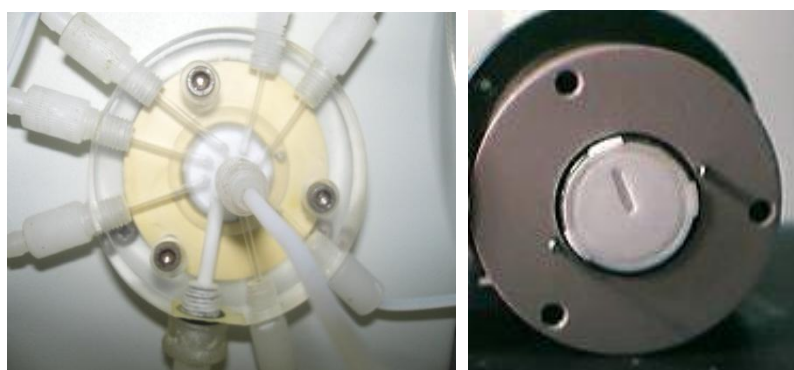

Figure 3.7 a) Left: Example of a LOV piece. b) Right: Rotor of the SV.

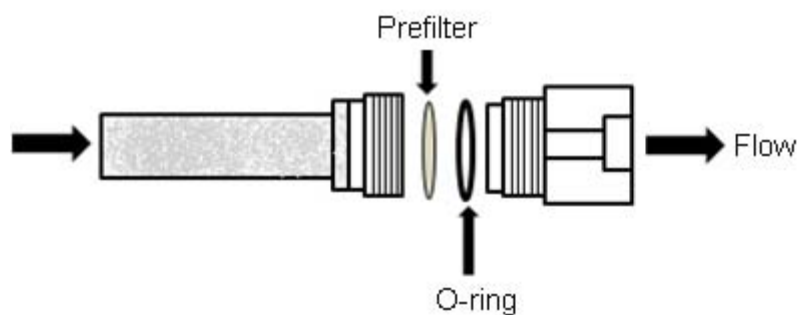

Figure 3.8 Port 1 of the LOV platform equipped with an O-ring (toric joint) and a prefilter to retain the beads.

3.1.4 Manifold components

The flow network manifold was constructed of flexible tubes of chemical resistant PTFE of 0.8 and 1.5 mm i.d., including holding coils (HC) and knotted reaction coils (KRC) (Fig. 3.9). Particular tube lengths are given at each developed manifold. All connections were made by means of polyvinylidene fluoride (PVDF) connectors, except cross-junctions, which are made of methacrylate.

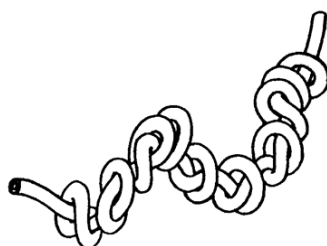

Figure 3.9 Knotted reaction coil (KRC).

3.2 Detectors

3.2.1 Spectrophotometric detection basis

In three of the methods presented in this thesis, spectrophotometric detection was used as an inexpensive screening tool, alternative to radiometric counters or ICP-MS. This allowed the development of fully automated portable analyzers.

A flow cell made from a 100 cm type II Teflon AF long path-length liquid core waveguide capillary cell (LWCC) (World Precision Instruments, FL, USA), with an internal diameter of 550 μm , an effective path length of 100.0 ± 0.5 cm, and an internal volume of 240 μL was used to enhance the LOD of the detection system (Fig. 3.10).

Taking into account that the absorbance is directly proportional to the path length, an improvement of two orders of magnitude in the signal regarding to a 1 cm path length cell was accomplished.

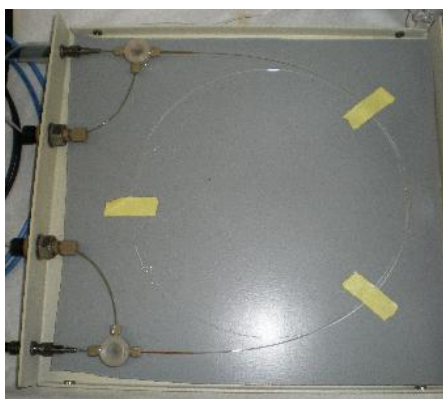

Figure 3.10 Inside of a 100 cm LWCC.

LWCCs^{6,7} are versatile and can enhance the sensitivity and improve limits of detection of optical instrumentation, by detecting as much of the optical signal as possible while minimizing background noise. LWCCs are based on the use of a capillary with a lower refractive index (n_1) than the liquid core contained in it (n_2), so the light introduced into the liquid core of the capillary is totally internally reflected down the capillary towards the detector (Fig. 3.11). They are connected to the light source and to the spectrophotometer through two optical fibres of 400 and 600 μm internal diameter (Ocean Optics, USA). The

⁶ L. J. Gimbert, P. J. Worsfold. Environmental applications of liquid-waveguide-capillary cells coupled with spectroscopic detection. *Trends Anal. Chem.* 26 (2007) 914–930.

⁷ F. Maya, J. M. Estela, V. Cerdà. Multisyringe flow injection analysis hyphenated with liquid core waveguides for the development of cleaner spectroscopic analytical methods: improved determination of chloride in waters. *Anal. Bioanal. Chem.* 394 (2009) 1577–1583.

detection system is composed apart from the above mentioned parts of a deuterium–halogen light source (Mikropack, Germany), and a USB 2000 miniaturized fibre optic spectrometer (Ocean Optics, USA), connected to a computer via an USB interface. The absorbance is measured at 660 nm and in order to compensate the Schlieren effect (light deviation due to a refractive index gradient, the index gradient is directly related to flow density gradient) 740 nm was selected as correction wavelength.

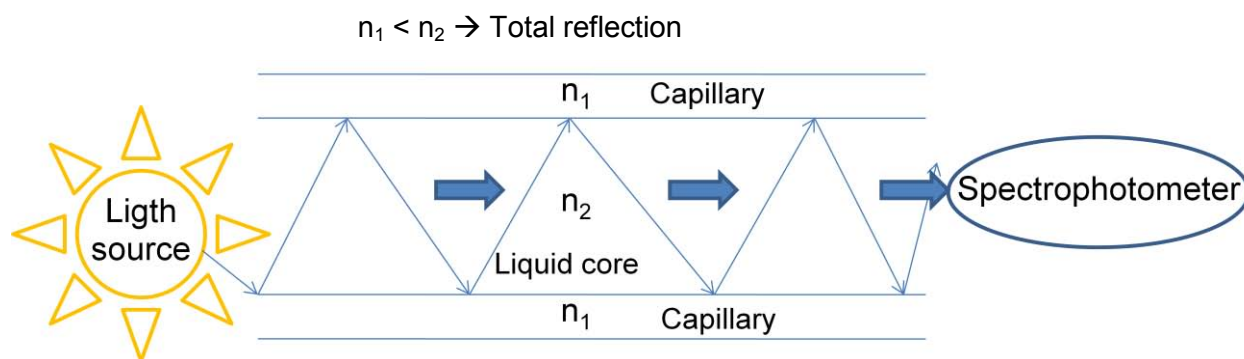

Figure 3.11 Depiction of the operation of a LWCC.

At the same time, uranium and thorium determination require high selectivity. Arsenazo-III (Fig. 3.12) was selected as colorimetric reagent since it is noteworthy for reacting with both uranium and thorium in strongly acid solutions and by specifying the pH it is possible to use arsenazo-III very selectively. These reactions are highly sensitive and have been successfully applied in prior works⁸⁻¹² due to the high stability of its uranium and thorium complexes.

⁸ H. Rohwer, N. Rheeder, E. Hosten. Interactions of uranium and thorium with arsenazo III in aqueous medium. *Anal. Chim. Acta* 341 (1997) 263-268.

⁹ M. H. Khan, A. Ali, N. N. Khan. Spectrophotometric determination of thorium with disodium salt of Arsenazo-III in perchloric acid. *J. Radioanal. Nucl. Chem.* 250 (2001) 353-357.

¹⁰ M. H. Khan, P. Warwick, N. Evans. Spectrophotometric determination of uranium with arsenazo-III in perchloric acid. *Chemosphere* 63 (2006) 1165-1169.

¹¹ A. Niazi, N. Ghasemi, M. Goodarzi, A. Ebadi. Simultaneous spectrophotometric determination of uranium and thorium using arsenazo-III by H-point standard addition method and partial least squares regression. *J. Chin. Chem. Soc.* 54 (2007) 411-418.

¹² J. B. Ghasemi, E. Zolfonoun. Simultaneous spectrophotometric determination of trace amounts of uranium, thorium, and zirconium using the partial least square method after their preconcentration by α -benzoin oxime modified Amberlite XAD-2000 resin. *Talanta* 80 (2010) 1191-1197.

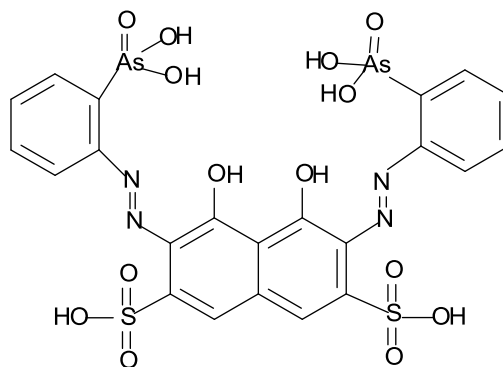

Figure 3.12 Schematic depiction of Arsenazo-III: 2,2'-(1,8-Dihydroxy-3,6-disulfonaphthylene-2,7-bisazo)bisbenzenearsonic acid.

Arsenazo-III¹³⁻¹⁵ is red, and it presents its maximum of absorbance at 540 nm at pH 2, while the absorption spectra of U-Arsenazo-III and Th-Arsenazo-III chelates show two maxima located at 610 and 660 nm (see Fig. 3.13). These maxima result from the presence of two weakly interacting chromophoric systems in the chelate molecule. Chelate formation (through one of the complexing groups) destroys the symmetry of the reagent molecule. The longer wavelength peak is ascribed to the functional group directly connected with the metal (U, Th), the other peak to the chromophoric centre (conjugated system) not directly connected to the metal, which, under the influence of the functional group changes to another ionic state. Arsenazo forms 1:1 complexes with doubly (UO_2^{2+}) and triply charged cations and it forms both 1:1 and 1:2 complexes, the latter when is present in large extent, with quadruply charged cations (Th). In Figure 3.14 are shown some suggested structures for 1:1 complexes¹⁴.

In particular, arsenazo-III reacts with uranium (as UO_2^{2+}) and Th (Th^{4+}), forming 1:1 complexes, with molar absorption coefficients of 53×10^3 and $13 \times 10^4 \text{ L mol}^{-1} \text{ cm}^{-1}$, respectively^{14,15}.

¹³ J. Fries, H. Getrost. Organic reagents for trace analysis (Merck), 1977, 384–391.

¹⁴ E.B. Sandell, H. Onishi. Photometric determination of traces of metals, fourth ed., John Wiley & sons, New York, 1979, 459-466.

¹⁵ E. Rowatt, R. J. P. Williams. The interaction of cations with the dye arsenazo III. Biochem. J. 259 (1989) 295-298.

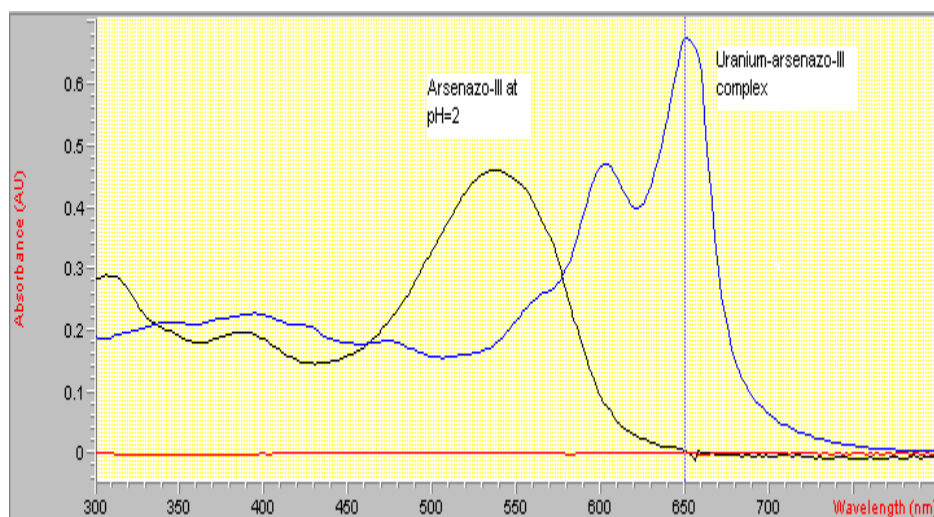

Figure 3.13 Absorbance spectra of the reagent arsenazo-III and the complex with uranium at pH 2.

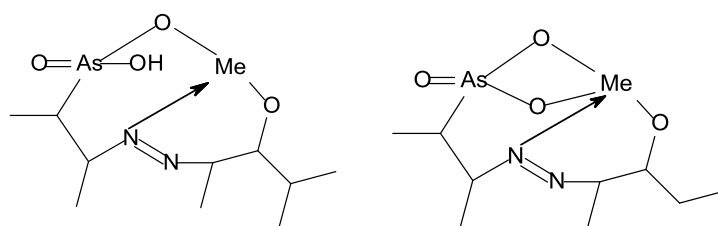

Figure 3.14 Suggested structures for the 1:1 arsenazo-III complexes.

3.2.2 ICP-MS detection

An ICP-MS Elan DCR-e (Perkin Elmer) was used in this thesis. The ICP-MS used consists of the following components:

- Sample introduction system – equipped with a cross flow nebulizer (Fig. 3.15) and a Scott spray chamber and provides the means of getting samples into the instrument. The liquid sample is introduced by a peristaltic pump to the cross flow nebulizer that creates an aerosol of fine droplets (Fig. 3.16). These fine droplets are passed through a Scott spray chamber before they are allowed to enter the plasma.
- ICP torch and radio frequency (RF) coil – generates the argon plasma, which serves as the ion source of the ICP-MS. This plasma creates a very hot zone (6000 °C) that serves a variety of functions. The plasma is generated by passing argon through a series of concentric quartz tubes (the ICP torch) that are wrapped at one end by a RF coil. Energy supplied to the coil by the RF generator couples with the argon to produce the plasma. Into

the plasma, the sample liquid droplets are dried to a solid and then heated to a gas. As the atoms continue their travel through the plasma, they absorb more energy and eventually release one electron to form singly charged ions which exit the plasma and enter the interface region.

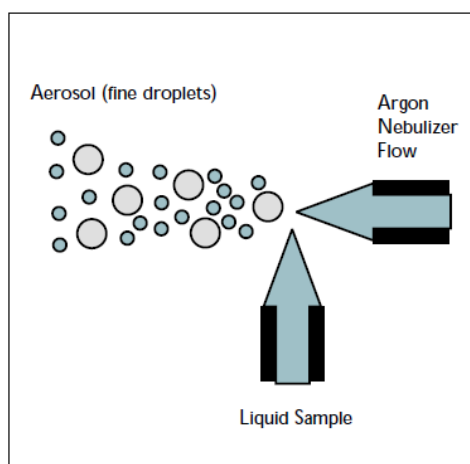

Figure 3.15 Cross-flow nebulizer.

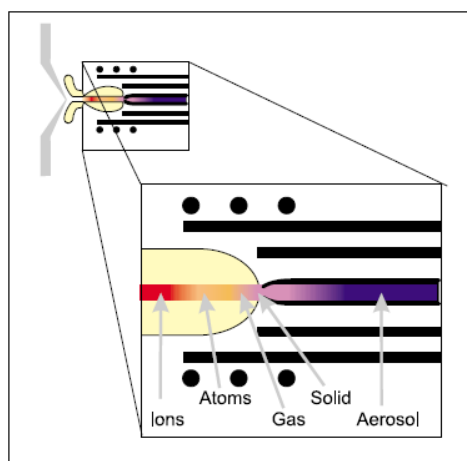

Figure 3.16 Form of sample in ICP-MS.

- Interface –The interface (Fig. 3.17) allows the plasma and the ion lens system to coexist (despite the large temperature difference and the high pressure) and the ions generated by the plasma to pass into the ion lens region. The interface consists of two inverted funnel-like devices called cones. The sampler cone is located next to the plasma and the skimmer cone is located several millimeters behind the sampler cone. These cones in the instrument used are produced from nickel. The orifice openings of the cones should be large enough to allow for the passage of the ion beam while, at the same time, not allow so much gas to enter the instrument that the instrument's vacuum system is taxed. The sampler and the skimmer cone have orifice openings of 1.1 mm and 0.9 mm, respectively.

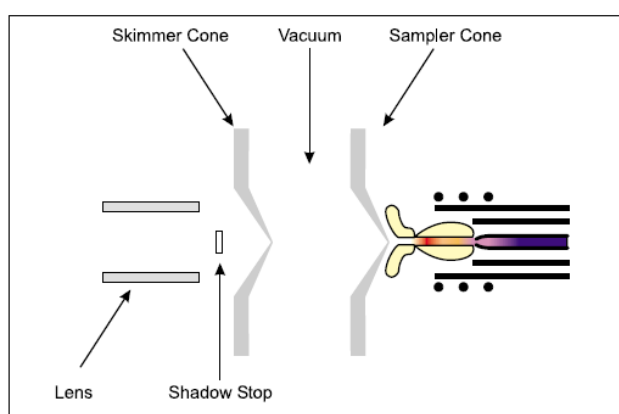

Figure 3.17 The ICP-MS interface.

- Lens – The ion lens is positioned immediately behind the interface. It is responsible for focusing ions into the quadrupole. Since the ions generated in the plasma are nearly all positively charged, they have a natural tendency to repel each other. In order to get as many of the ions as possible into the quadrupole, it is necessary to keep the ion beam from diverging. This is achieved by passing the ions through a charged metallic cylinder that acts as a focusing lens. Since the charge on the lens is the same as the charge on the ions, the ions are repelled back toward each other to form a focused ion beam. The small disk located between the skimmer cone and the cylinder lens is the shadow stop. This device keeps the photons and unionized materials emitted from the plasma from moving downstream where they could have an adverse effect on the performance of the ICP-MS. The mass spectrometer uses an electrical field to focus the ion beam.
- Vacuum system – provides high vacuum for ion optics, quadrupole and detector. If an ion has to travel the distance between the interface and the detector (< 1 m), it cannot collide with any gas molecules. This requires removal of nearly all of the gas molecules in the space between the interface and the detector. This task is accomplished using a combination of a turbo molecular pump and mechanical roughing pump, which comprise the main components of the vacuum system. The turbo molecular pump works like a jet turbine and is capable of rapidly pumping a chamber to a pressure of 1.3×10^{-3} Pa or less. The roughing (mechanical) pump backs the turbo molecular pump and evacuates the interface region.
- Reaction cell –The quadrupole ICP-MS (Fig. 3.18) was equipped with a reaction cell (DRC-e) which can significantly suppress the interfering isobaric ions by choice of an appropriate reaction gas. For thorium and uranium determination in environmental samples this was not necessary.
- Mass spectrometer – acts as a mass filter to sort ions by their mass-to-charge ratio (m/z). A quadrupole consists of 4 rods approximately 20 cm in length and 1 cm in diameter and works by setting voltages and radio frequencies to allow ions of a given mass-to-charge ratio to remain stable within the rods and pass through to the detector (Fig. 3.19). Ions with different mass-to-charge ratios are unstable in the cell and are ejected. Under the control of the instrument software, the mass spectrometer can move to any m/z needed to measure the elements of interest in the sample analyzed. The quadrupole is capable of scanning at a rate > 5000 atomic mass units (amu) per second. This is the reason why ICP-MS can determine so many different elements quickly even though only one mass passes through the quadrupole at a time.

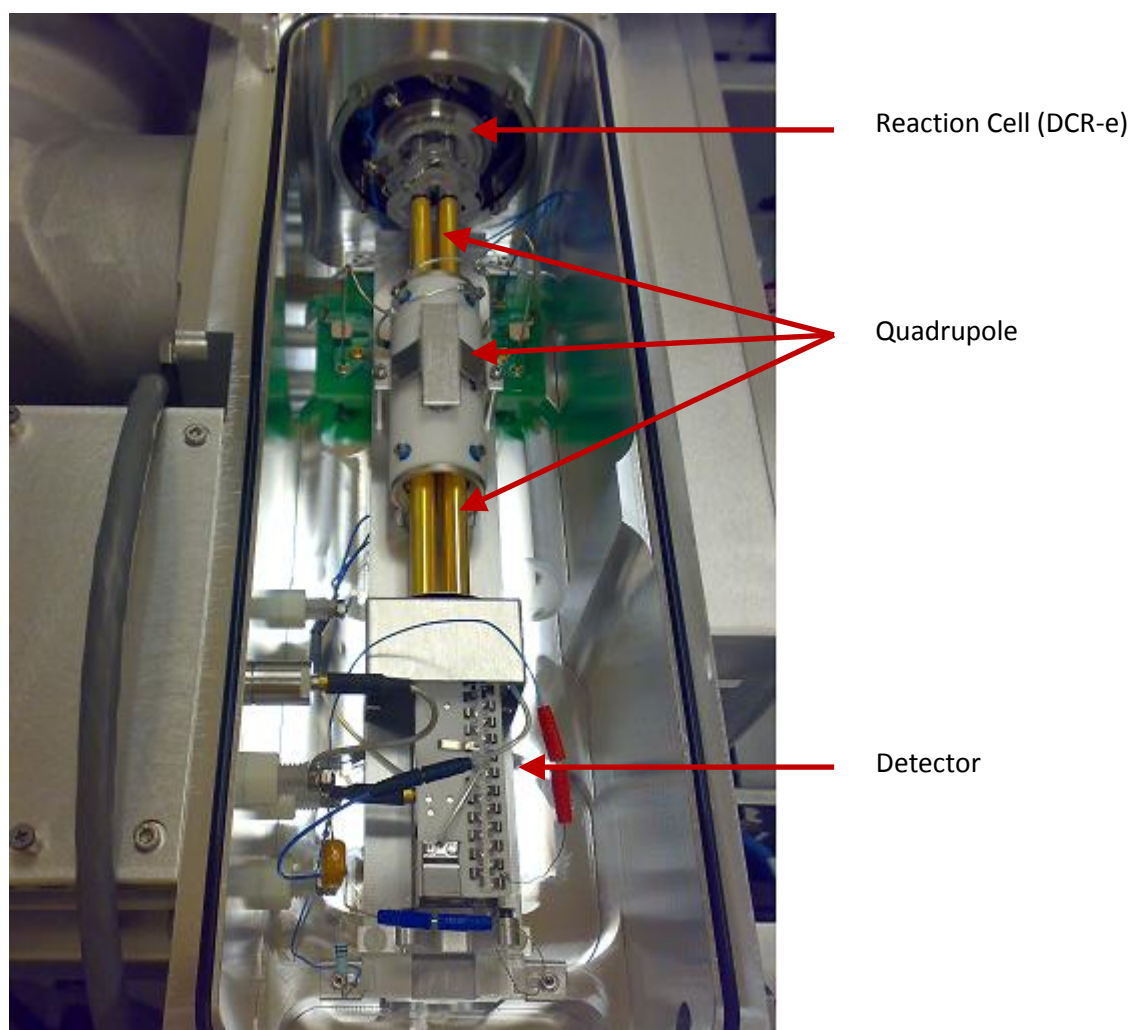

Figure 3.18 Photograph of the reaction cell, the quadrupole and the detector of the ICP-MS used.

- Detector – counts individual ions exiting the quadrupole. The active surface of the detector, known as a dynode, releases an electron each time an ion strikes it. The ion exiting the quadrupole strikes the first dynode which releases electrons and starts the amplification process. The electrons released from the first dynode strike a second dynode where more electrons are released. This cascading of electrons continues until a measurable pulse is created. By counting the pulses generated by the detector, the system counts the ions that hit the first dynode.

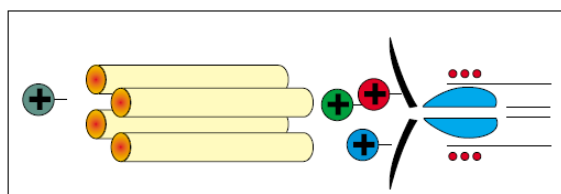

Figure 3.19 Quadrupole mass filter.

- Data handling and system controller – controls all aspects of instrument control and data handling to obtain final concentration results.

3.3 Separation and preconcentration techniques used

In order to separate and preconcentrate analytes, solid phase extraction (SPE) was applied. Although there are various kinds of resin, two commercial chromatographic resins from Triskem Industries (France) were selected. It is well known that uranium and tetravalent actinide specific resin UTEVA[®] and transuranium specific resin TRU are very applicable for separation of U and Th from various types of samples. Moreover, preconcentration improves the detection limits, increases the sensitivity and enhances the accuracy of the results.

The separation of the radionuclides is based on the distribution of the cations of interest between an organic and an aqueous phase. The extractant is adsorbed on the surface of an inert support and corresponds to the organic, stationary phase.

Some advantages derived from using these materials are the substantial minimization of sample and reagents consumption, as well as the ease of the analytical procedure. Analytical expectations can be outranged if the total automation of the methodology is achieved.

3.3.1 TRU resin

TRU (TRansUranide) resin is an extraction chromatographic material based on a bifunctional organophosphorus extractant, widely used for trace actinide isolation in complex samples¹⁶⁻¹⁸. The extractant system is octylphenyl-N,N-di-isobutyl carbamoylphosphine oxide (abbreviated CMPO) dissolved in tri-n-butyl phosphate (TBP) (Fig. 3.20).

The CMPO/TBP solvent system complexes actinide elements and extracts them out of certain aqueous solutions. Most matrix elements show no or little retention on the resin in acidic media and can be isolated from the actinides during the sample load and washing steps.

¹⁶ O.B. Egorov, M.J. O'Hara, O.T. Farmer III, J.W. Grate. Extraction chromatographic separations and analysis of actinides using sequential injection techniques with on-line inductively coupled plasma mass spectrometry (ICP-MS) detection. *Analyst* 126 (2001) 1594–1601.

¹⁷ J. Mellado, M. Llaurodo, G. Rauret. Determination of actinides and strontium in fish samples by extraction chromatography. *Anal. Chim. Acta* 458 (2002) 367–374.

¹⁸ Y. Fajardo, L. Ferrer, E. Gómez, F. Garcías, M. Casas, V. Cerdà. Development of an automatic method for americium and plutonium separation and preconcentration using a multisyringe flow injection analysis multipumping flow system. *Anal. Chem.* 80 (2008) 195–202.

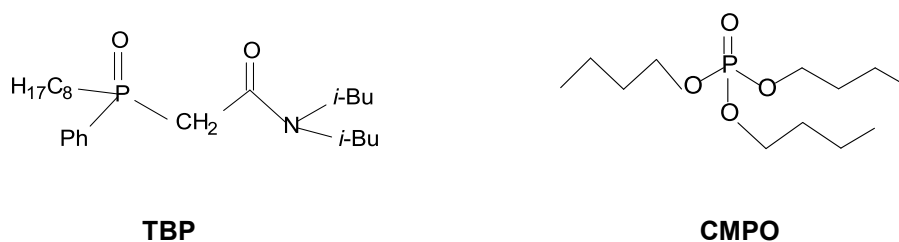
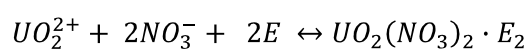

Figure 3.20 Structure of TRU resin extractant system, TBP and CMPO.

Assumed extraction equilibrium for uranium:



With, E = extractant.

3.3.2 UTEVA[®] resin

UTEVA[®] (Uranium and TEtraValents Actinides) resin is an extraction chromatographic material widely used for uranium and tetravalent actinides isolation¹⁹⁻²². The extractant is diamyl, amyolphosphonate (DAAP, Fig. 3.21), and it forms nitrate complexes with uranium(VI), thorium(IV), neptunium(IV) and plutonium(IV). Therefore, the nitric acid concentration is a limiting factor for the uptake of these complexes.

¹⁹ I. W. Croudace, P. E. Warwick, R. C. Greenwood. A novel approach for the rapid decomposition of actinide resin and its application to measurement of uranium and plutonium in natural waters. *Anal. Chim. Acta* 577 (2006) 111-118.

²⁰ A. Fujiwara, Y. Kameo, A. Hoshi, T. Haraga, M. Nakashima. Application of extraction chromatography to the separation of thorium and uranium dissolved in a solution of high salt concentration. *J. Chromatogr. A* 1140 (2007) 163-167.

²¹ E. Manickam, S. Sdraulig, R. A. Tinker. Method design and validation for the determination of uranium levels in human urine using high-resolution alpha spectrometry. *J. Environ. Radioactiv.* 99 (2008) 497-501.

²² H. Rameback, U. Nygren, P. Lagerkvist, A. Verbruggen, R. Wellum, G. Skarnemark. Basic characterization of ²³³U: Determination of age and ²³²U content using sector field ICP-MS, gamma spectrometry and alpha spectrometry. *Nucl. Instr. Meth. A* 266 (2008) 807-812.

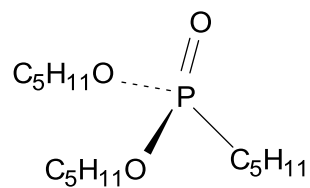
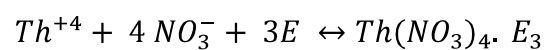
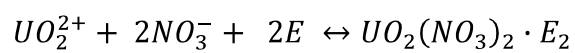

Figure 3.21 Structure of UTEVA[®] resin extractant.

Assumed extraction equilibria for thorium and uranium:



With, E = extractant.

3.4 Software

Instrumental control, data acquisition and processing were carried out with the software package AutoAnalysis 5.0. It was fundamentally described by Becerra et al. (1999)²³, developed in our group and commercialized by Sciware³ S.L. The software is written in Delphi and Visual C++ and offers a window-based graphical surface. It runs on all 32-bit operation systems from Microsoft Corporation® (MS-Windows XP).

The distinctive feature of this software based on dynamic link libraries (DLLs) at 32 bits is the possibility of using a single and versatile application without further modification for whatever instrumentation and detection system needed. It involves a basic protocol which allows the implementation of specific and individual DLLs, addressing the configuration of the assembled flow analyzer. Thus being a very flexible tool, easy to handle by non-specialised users.

3.4.1 System configuration

The establishment of a communication protocol or “channel” (e.g. RS232, RS485, USB, IEEE488), incorporation and configuration of the connected hardware (e.g. syringe pump, spectrometer, etc) are carried out via individual dynamic link libraries (DLL). Since, these are installed and loaded as required for each system forming an individual configuration, modification of the instrumentation assembly requires a minimum of adaptation effort (Fig. 3.22). Program versatility is only limited by the availability of the required DLLs. Up-to-now, DLLs for seven communication channels and 30 devices are available including atomic fluorescence, molecular fluorescence, spectrometric and electrochemical detectors, autosampler, syringe-, peristaltic-, and solenoid-micropumps, valve modules, and I/O, A/D, or D/A PC digital cards for the connection and communication with other devices. In this work, DLLs for the communication channels Ocean Optics (USB), Generic Serial (RS485) and Serial Crison (RS232), and Automatic Multisyringe Crison, Automatic Valve Module Crison, Ibercomp Pump and Valve, Autosampler Crison, and Spectrometer Ocean Optics instruments were used. After loading the required configuration for the connected instruments, they can be addressed in each method and corresponding command forms become available in the editor window in addition to the basic and former described functions. Data processing is the same independently of the instruments or configuration loaded. At the same time, data processing and method development are centralized,

²³ E. Becerra, A. Cladera, V. Cerdà. Design of a very versatile software program for automating analytical methods. *Lab. Robot. Autom.* 58 (1999) 131-140.

providing ease of use for the users by minimizing the time and efforts required to incorporate a new instrument to the system.

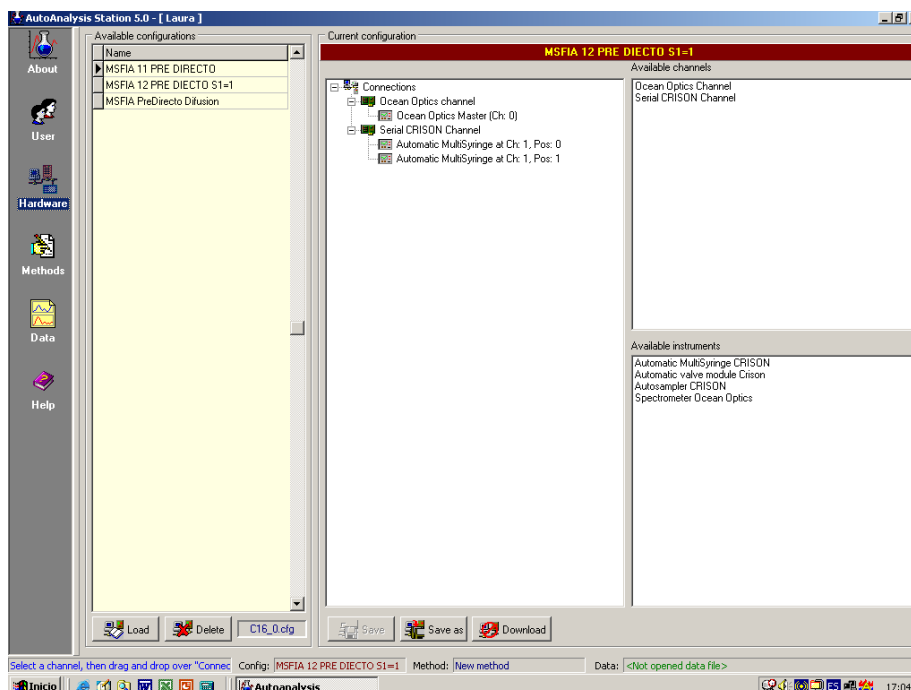

Figure 3.22 Hardware window, where channels and instruments are loaded to establish a configuration.

3.4.2 Method edition

The analytical method is created by sequencing functions (e.g. wait, variable and conditionals) or instructions for the instruments by their selection from a pull-down menu and assigning specified commands to them (Fig. 3.23). This provides a variability of programming functions for method creation including procedures, loops, indexing, basic calculations, variables, user input, waiting steps, event marking, comments, conditional enquiries, and on-line data processing. Further functions enable method test execution, definition of detection thresholds, manual data processing, such as calibration, data smoothing, spectral information processing, peak adjustment, and data export. Furthermore, this software allows the use of conditionals which enables the development of smart systems.

Procedures are prior-created instruction protocols, which can be loaded by all methods within the same hardware configuration. Main advantages are higher method clearness by apparent shorting, module-like programming, and repeated application in the same method.

It is important to note that pump operations could be carried out either exclusively, i.e. the next instruction is not processed until the pump stops, or no-exclusive, i.e., the next

instruction is processed already after initialization of the pump operation, which is then executed in background.

The window “Execute” enables method initiation, pause, stop, as well as the control of the execution and continuously acquired data. Zoom, scale, and shift functions are also available.

Taking advantage of these features allows the creation and optimization of highly versatile applications. Based on 32-bit technology, AutoAnalysis allows multitasking operations such as simultaneous method execution and data processing, multiple loading, and working with other programs running at the same time.

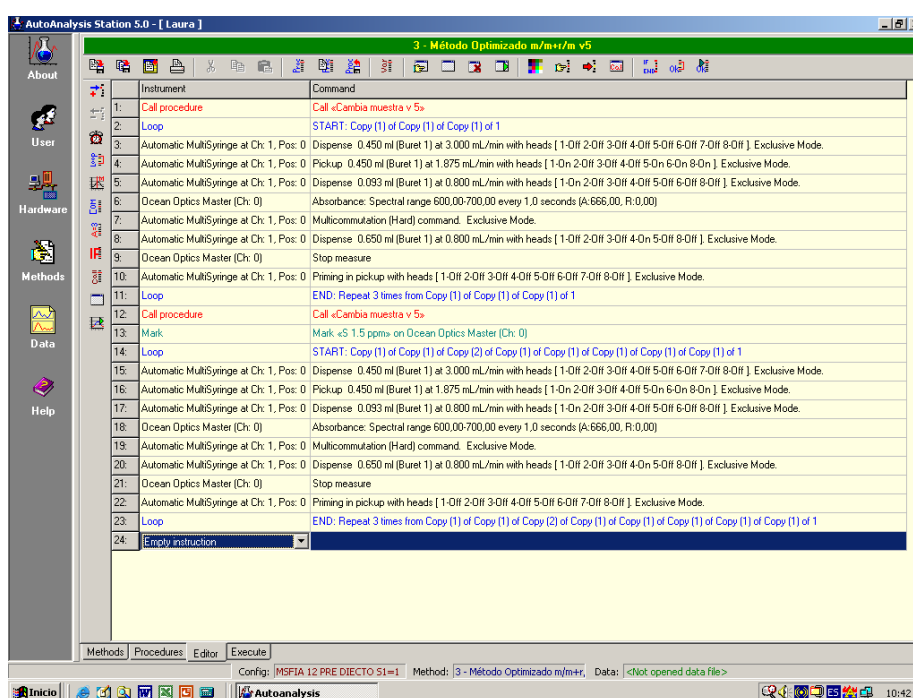

Figure 3.23 Method edition window

3.4.3 Data processing

AutoAnalysis offers tools for data processing after method termination such as zoom functions, visualization of the original acquired data as well as of a smoothed function, baseline, and peak data. It allows peak height and peak area calibration, data export and saving, basic calculations, and overlay with prior acquired data (Fig. 3.24). For peak maximum, start-, and end-point identification, thresholds for the numerical first and second derivative and a peak height minimum can be defined. Manual, mouse-drag peak correction, adding of non-identified peaks or elimination of error-peaks is further possible. On-line data processing is also possible by the use of conditionals.

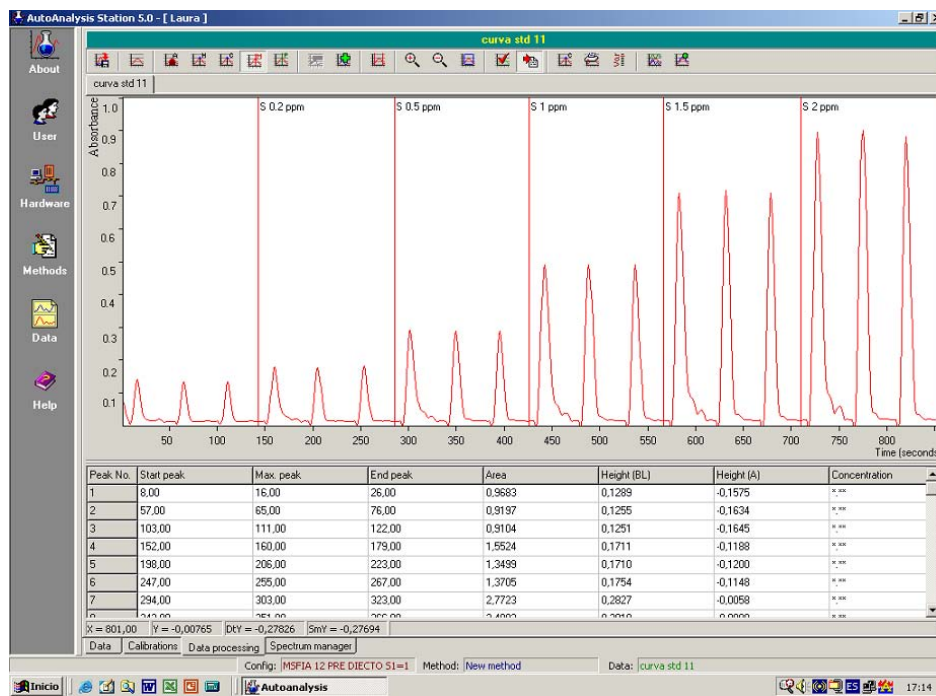

Figure 3.24 Diagram and register table of the analytical signals.

3.5 Multivariate optimization

Analytical chemists are constantly performing experiments for a very wide variety of reasons. The term optimization has been commonly used in analytical chemistry as a means of discovering the conditions that produce the best output. Traditionally, optimization in analytical chemistry has been carried out by monitoring the influence of one factor at a time on an experimental response. While only one parameter is changed, others are kept at a constant level. This optimization technique is called one-variable-at-a-time. Its major disadvantages are that it does not include the interactive effects among the variables studied and that it is time consuming. Moreover, there is a risk of misinterpreting the results if important interactions between factors are presented. Interaction between variables can be relevant and not taking into account them can give wrong results.

In order to overcome this problem, the optimization of analytical procedures has been carried out by using multivariate statistic techniques. Among the most relevant multivariate techniques used in analytical optimization is response surface methodology²⁴⁻²⁶. Response surface methodology is a collection of mathematical and statistical techniques based on the fit of a polynomial equation to the experimental data, describing the behaviour of a data set with the objective of making statistical previsions. The objective is to simultaneously optimize the levels of the variables to attain the best system performance. Since, the response in any point of the experimental domain can be predicted a graphical representation can be easily obtained²⁷.

By comparing univariate design with multivariate design, it is possible to say that:

- Experimental design takes into account the interactions among the variables, while the univariate design does not.
- Experimental design provides a global knowledge (in the whole experimental domain), while the univariate design gives a local knowledge (only where the experiments have been performed).
- In each point of the experimental domain, the quality of the information obtained by experimental design is higher than the obtained by the univariate design.

²⁴ T. Lundstedt, E. Seifert, L. Abramo, B. Thelin, A. Nyström, J. Pettersen, R. Bergman. Experimental design and optimization. *Chemomet. Int. Lab. Syst.* 42 (1998) 3-40.

²⁵ M. A. Bezerra, R. E. Santelli, E. P. Oliveira, L. S. Villar, L. A. Escalera. Response surface methodology (RSM) as a tool for optimization in analytical chemistry. *Talanta* 76 (2008) 965-977.

²⁶ R. Leardi. Experimental design in chemistry: A tutorial. *Anal. Chim. Acta* 652 (2009) 161-172.

²⁷ R. G. Brereton. *Chemometrics, Data analysis for the laboratory and chemical plant.* John Wiley & sons, New York, 2003.

- The number of experiments required by an experimental design is smaller than those performed with a univariate approach.

Also, it should be clear that:

- The quality of the results depends on the distribution of the experiments in the experimental domain.
- The optimal distribution of the experiments depends on the postulated model.
- Given the model, the experimental limitations and the budget available (= maximum number of experiments), the experimental design will detect the set of experiments resulting in the highest possible information.

Some terms that will be further used are defined below:

- Experimental domain is the experimental field that must be investigated. It is defined by the minimum and maximum limits of the experimental variables studied.
- Experimental design is a specific set of experiments defined by a matrix composed by the different levels combinations of the variables studied. A design defines a specific set of combinations for the levels of variables that must be applied experimentally to obtain the responses.
- Factors or independent variables are experimental variables that can be changed independently of each other.
- Levels of a variable are different values of a variable at which the experiments must be carried out. In these designs each variable has three levels, coded as +1, 0 and -1, respectively. Codification of the levels of the variable consists of transforming each studied real value into coordinates inside a scale with dimensionless values, which must be proportional at its localization in the experimental space.
- Responses or dependent variables are the measured values of the results from experiments. A typical response is the analytical signal (absorbance, counts, etc).
- Residual is the difference between the calculated and the experimental result for a determinate set of conditions. A good mathematical model fitted to experimental data must present low residuals values.
- Pure error is the random fluctuation of measurements.

As general rule, when the experimental variables and the responses have been defined, the experiments can be planned and performed in such a way that a maximum of information is gained from a minimum of experiments. Screening is the first step in the efficient assessment of the factors involved in an analytical system under study. Thus, it can be said that a major role of experimental design is in screening. After determining the significant factors, the optimum operation conditions are attained by using more complex

experimental designs such as Doehlert matrix (DM), central composite designs (CCD) or three-level designs such as the Box-Behnken design (BBD).

3.5.1 Screening

In any experimental procedure, several experimental variables or factors may influence the result. A screening experiment is performed in order to determine the experimental variables and interactions that have significant influence on the result, measured in one or several responses^{28,29}.

In screening studies linear or second order interaction models are common, such as full factorial or fractional factorial designs. In a factorial design the influences of all experimental variables, factors, and interaction effects on the response or responses are investigated. Three centre points were and should always be included in factorial designs, due to the risk of missing non-linear relationships in the middle of the intervals is minimized, and repetition allows the determination of confidence intervals.

3.5.1.1 Factorial designs

These were used in the screening of the methods presented in this thesis. Full factorial designs are most useful when the number of factors is relatively limited. For a typical factorial design, it is necessary to determine how many factors are of interest, and how many levels each factor is to be studied at. An “n” factor, “k” level design involves performing k^n experiments.

First, it is necessary to establish the experimental domain; there is no guarantee that the results will be valid outside this region. The second step is to choose a design. Basically, choose the “k” levels depending on the number of factors to be studied “n”. Two level ($k = 2$) designs were used in the developed methods. Then a mathematical model can be produced relating the response to the factors. Often a linear model is obtained of the form:

$$\hat{y} = b_0 + b_1x_1 + b_2x_2 + b_{12}x_1x_2$$

Where \hat{y} represents the estimated response, b_0 is the average experimental response, the coefficients b_1 and b_2 are the estimated effects of the factors considered and the extent

²⁸ P. W. Araujo, R.G. Brereton. Experimental design I. Screening. Trends Anal. Chem. 15 (1996) 26-31.

²⁹ J. N. Miller, J. C. Miller. Statistics and chemometrics for analytical chemistry. Pearson Education Ltd, Harlow, 5th Ed., 2005.

to which these terms affect the performance of the method is called main effect. The coefficient b_{12} would be the interaction term. Factorial design provides information about the importance of interactions between the factors. Reduced factorial designs are employed when a large number of factors have to be studied, since the number of experiments is reduced but they are subject to some restraints because main effects can be confounded with interaction terms. From a geometrical point of view, a factorial design explores the corners of a cube (if the variables are more than three it will be a hypercube).

Two-level factorial designs are used in the estimation of first-order effects, but they fail when additional effects, such as second-order effects, are significant. So, central points in two-level factorial designs can be used for evaluating curvature.

The evaluation of the screening, such as p-value for variables, curvature, lack of fit, correlation coefficient and residuals, allows the selection of the representative variables and its ranges. Nonetheless, in order to determine a critical point it is necessary for the polynomial function to contain quadratic terms (response surface).

3.5.2 Response surface

Response surfaces are used to determine the critical values of independent variables which provide the best response³⁰. In addition, it is a good way to graphically illustrate the relation between different experimental variables and the responses. To be able to determine an optimum it is necessary that the polynomial function contains quadratic terms. For quadratic models, the critical point can be characterized as maximum, minimum, or saddle. It is possible to calculate the coordinates of the critical point through the first derivate of the mathematical function, which describes the response surface and equates it to zero.

Among the more known second order symmetrical designs³¹ are the three-level factorial design, Box–Behnken design³², central composite design, and Doehlert design. Central composite designs are the result of superimposing a factorial design at 2 levels (2^n) on a star design ($2n + 1$), being the total number of factor combinations $2^n + 2n + 1$ to define the linear, quadratic and interaction terms of the model together with an estimation of the error in the terms.

Face centred central composite designs with resolution V (first and second order interactions perfectly estimated) have been mostly used in the optimization of the proposed methods. The name “Face Centered” derives from the fact that the location of the star points

³⁰ P.W. Araujo, R.G. Brereton. Experimental design II. Optimization. Trends Anal. Chem. 15 (1996) 63-70.

³¹ D.C. Montgomery. Design and analysis of experiments. John Wiley & sons, New York, 7^a Ed, 2009.

³² S.L.C. Ferreira, R.E. Bruns, H.S. Ferreira, G.D. Matos, J.M. David, G.C. Brandao, E.G.P. da Silva, L.A. Portugal, P.S. dos Reis, A.S. Souza, W.N.L. dos Santos. Box-Behnken design: An alternative for the optimization of analytical methods. Anal. Chim. Acta 597 (2007) 179-186.

correspond to the centre of the faces of the cube. A drapper line small central composite design was also used when many factors were representative in order to minimize the number of experiments to be carried out. Draper-Lin designs are small central composite designs that consist of a fractional factorial or Plackett-Burman design of less than resolution V (resolution IV, first order interactions perfectly estimated but second order interactions can be confused with other interactions), with added star points.

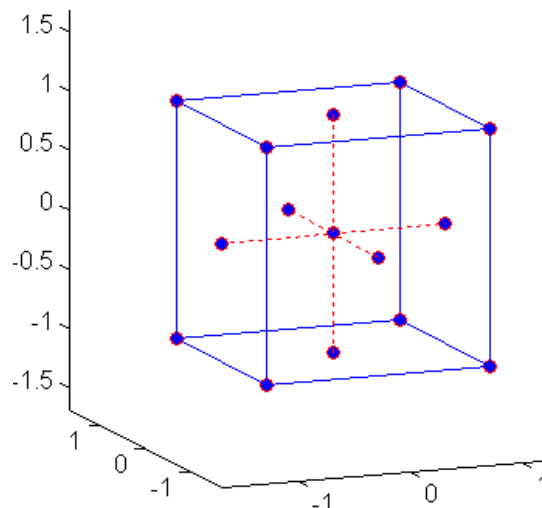

Figure 3.25 Face centered CCD for three variables and central points.

The mathematical model found after fitting the function to the data can sometimes not satisfactorily describe the experimental domain studied. The more reliable way to evaluate the quality of the model fitted is by the application of analysis of variance (ANOVA).

The central idea of ANOVA is to compare the variation due to the treatment (change in the combination of variable levels) with the variation due to random errors inherent to the measurements of the generated responses. From this comparison, it is possible to evaluate the significance of the regression used to foresee responses considering the sources of experimental variance. Moreover, as replicates of the central point are made, it is possible to estimate the pure error associated with repetitions. Several models including linear and quadratic models are checked in order to choose the one which fits better to the experimental data. To fit a mathematical model with the experimental data, the experimental design must be performed with authentic repetitions at least in its central point.

3.5.2.1 Desirability function

An increasingly popular form for treating multiple responses makes use of the Derringer function or desirability function D , which was proposed by Derringer and Suich in 1980³³. Individual response surfaces are determined for each response. Predicted values obtained from each response surface are transformed to a dimensionless scale d_i . The scale of the desirability function ranges between $d=0$ (for an undesirable response) and $d=1$ (for completely desirable one). D is calculated combining the individual desirability values by applying the geometric mean: $D = (d_1 \times d_2 \times \dots \times d_m)^{1/m}$. An algorithm is then applied to the D function in order to determine the set of variable values that maximize it. This function has been used during the optimization of analytical systems, which involve several responses.

Thus, the simultaneous optimization process is reduced to find the levels of factors that demonstrate the maximum overall desirability. The application of desirability functions in analytical chemistry brings advantages such as efficiency, economy, and objectivity in the optimization of multiple response procedures.

In conclusion, experimental design gives very good tools making easier to understand the problem; anyway, the final decision must rely on a practical basis.

Different statistical programs were used to carry out the optimization of the developed methods e.g. Minitab 15, Statgraphics XV and Statistica 6. Particular information regarding each method optimization is given in more detail in their respective chapters.

³³ G. Derringer, R. Suich. Simultaneous-optimization of several response variables. *J. Qual. Technol.* 12 (1980) 214-219.

Chapter 4

Automated determination of uranium(VI) at ultra trace levels exploiting flow techniques and spectrophotometric detection using a liquid waveguide capillary cell

4.1 Introduction

In this chapter, an automated, low-cost, robust, portable and rapid analyzer for total uranium determination in environmental samples is presented. Multisyringe flow injection analysis and a multipumping flow system were coupled to a long path length capillary cell to develop a sensitive spectrophotometric method for ultra-trace uranium determination. The features of this method make it a powerful tool for screening sample analyses reporting quickly the presence and concentration of uranium.

The hyphenation of MSFIA with MPFS improved their individual capabilities, since both are especially suitable for minimization of reagent consumption and enable the introduction of large sample volumes in a short time. This is an aspect of great importance when designing automatic methods for determination of radioactive isotopes in environmental samples, where low concentrations are encountered. These low concentrations and the presence of high levels of potentially interfering matrix make necessary a separation and preconcentration treatment step prior detection. TRU resin was selected for this purpose, due to its capability to extract uranium and since large number of commonly occurring matrix elements show no or little retention in nitric acid media and can be separated from actinides during sample load and column wash steps.

Arsenazo-III was selected as colorimetric reagent because it has been reported as the most sensitive chromogenic reagent based on azo dyes and because the high stability of the 1:1 uranium complex.

Some figures of merit of this method should be highlighted, such as the limit of detection (LOD) achieved, 1.26 ng U, and taking into account the preconcentration factor attained, 100:1, which is also responsible of the low LOD in concentration units, 12.6 ng L⁻¹. This LOD is lower than those obtained using radiometric detection and similar to other methods using ICP-MS, reaching the present limit levels established for uranium in drinking waters by legislation.

Moreover, this methodology was evaluated by analyzing four different water matrixes (fresh water, mineral water, tap water and seawater), phosphogypsum, and vegetable ashes. Thus, this method is proposed as an inexpensive screening tool for total uranium determination in samples of environmental interest.

4.2 Original paper

The published paper “Automated determination of uranium(VI) at ultra trace levels exploiting flow techniques and spectrophotometric detection using a liquid waveguide capillary cell” by J. Avivar, L. Ferrer, M. Casas and V. Cerdà in *Analytical and Bioanalytical Chemistry* 397 (2010) 871-878, is attached in the following pages. The journal *Analytical and Bioanalytical Chemistry* (impact factor: 3.841 year 2010), is located at the first quartile of the journals of the Analytical Chemistry area.

Supplementary information regarding to the optimization process is provided after the published paper.

4.3 Additional optimization information

In order to find the best operational conditions for separation, preconcentration and detection analysis of ultra-trace levels of uranium in the MSFIA-MPFS system a series of investigations were conducted. Amongst the various parameters affecting the performance of the sorbent bead-injection preconcentration in terms of sorption efficiency for U, sample medium (HNO_3 concentration), loading flow rate and stripping conditions were optimized in previous assays.

Five potentially critical variables were taken into consideration, namely, the arsenazo-III volume, the arsenazo-III concentration, the eluent concentration, the eluent volume and the buffer concentration.

The computer statistics packages Statgraphics Centurion XV and Statistica 6 were used to build a multivariate two-level fractional factorial design to screen the variables and the interactions between them having a significant influence upon the trace element determination (analytical response) and to discard those with negligible effects on the response. The experimental design was built in a dimensionless coordinate system using factor coding, wherein the highest and lowest levels are given as +1 and -1, respectively. Three center points were included, to identify any irregularities, such as loss of linearity in the center of the interval. Results showed that the curvature and the five variables studied were significant. Finally, a response surface Drape-Lin small composite experimental design with a total number of 25 experiments was resorted to find the critical value of the variables for the uranium determination. More detailed information is attached below.

4.3.1 Screening U determination: 5 variables

4.3.1.1 Screening Design Attributes

Design class: Screening

Design name: Factorial $2^{(5-1)}$

4.3.1.2 Base Design

Number of experimental factors: 5

Number of responses: 1

Number of runs: 19, including 3 centerpoints

Randomized: Yes

4.3.1.3 Table of the studied ranges

Variable	Encoded to decoded values		
	-1	0	1
Arsenazo III volume (mL)	0.1	0.55	1
Arsenazo III concentration (%)	0.00001	0.000055	0.0001
Eluent volume (mL)	0.1	0.3	0.5
Eluent concentration (mol L ⁻¹)	0.01	0.03	0.05
Buffer concentration (mol L ⁻¹)	0.1	0.2	0.3

4.3.1.4 Results of the screening

In order to evaluate the screening results, an ANOVA table, a Pareto chart, a fit of observed vs predicted values, and a histogram of residuals were analyzed. To determine whether a variable is significant or not, the p-value is used, i.e. when the p value obtained is < 0.05, the variable is said to be statistically significant (marked with an asterisk at the ANOVA table, table 4.1).

As can be seen in the ANOVA table and the Pareto chart (Fig. 4.1) all the variables studied and their interactions were significant into the experimental domain. Moreover, as can be seen at the Pareto chart and at the ANOVA table although having used a fractional factorial design, main effects were not confounded with interaction terms. Besides, the fit between the observed and predicted values showed a good distribution (Fig. 4.2), and the profile of histogram was close to a normal distribution (Fig. 4.3).

Since results showed that the curvature and the five variables studied were significant, a response surface Draper-Lin small composite experimental design with a total number of 25 experiments was resorted to find the critical value of the variables for the uranium determination.

Table 4.1 ANOVA table of the screening for the MSFIA-MPFS-LWCC-uranium system.

Factor	p
Curvature	0.000250*
(1)Buffer concentration	0.003069*
(2)Arsenazo concentration	0.000098*
(3)Arsenazo volume	0.000205*
(4)Eluent volume	0.000013*
(5)Eluent concentration	0.000129*
1 by 2	0.000101*
1 by 3	0.000316*
1 by 4	0.003553*
1 by 5	0.001640*
2 by 3	0.001446*
2 by 4	0.000118*
2 by 5	0.000358*
3 by 4	0.000208*
3 by 5	0.000104*
4 by 5	0.000137*
Factor	Value
Pure error (MS)	0.0000045
R-sqr	0.99999
Adj.	0.99988

The pure error is expressed as mean square (MS).

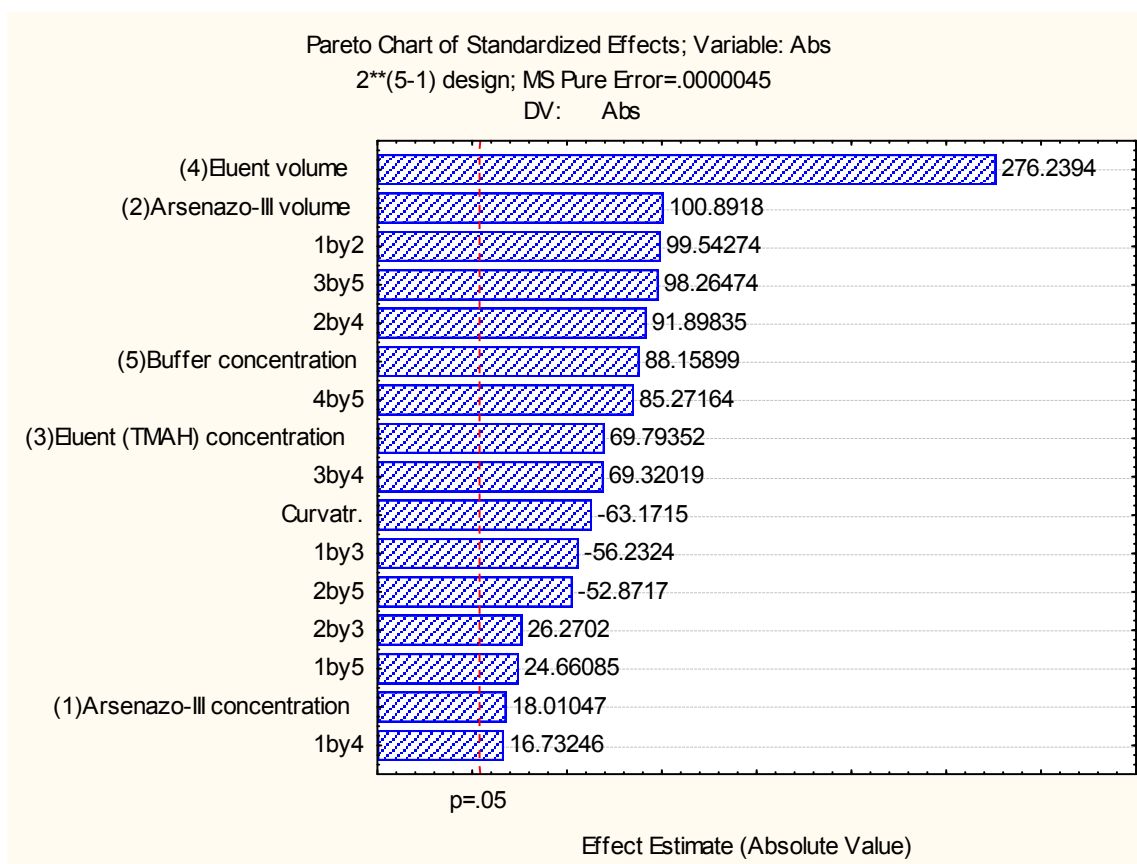

Figure 4.1 Pareto chart of the screening.

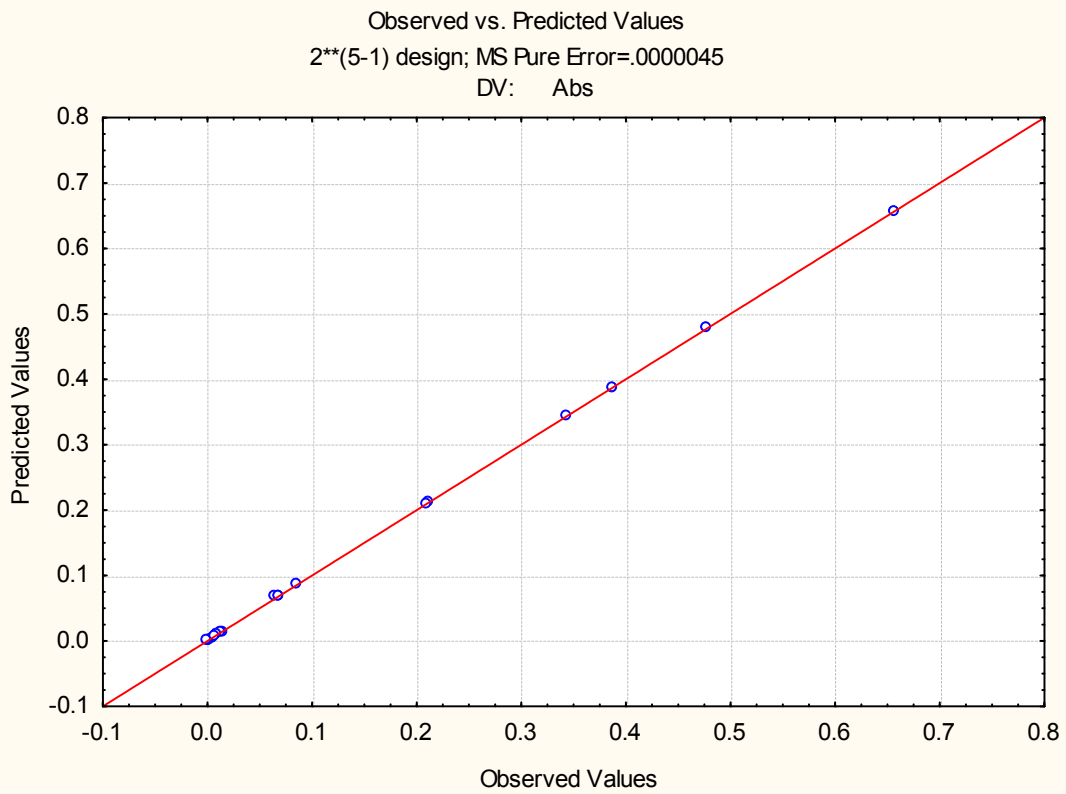

Figure 4.2 Predicted versus observed values of the screening.

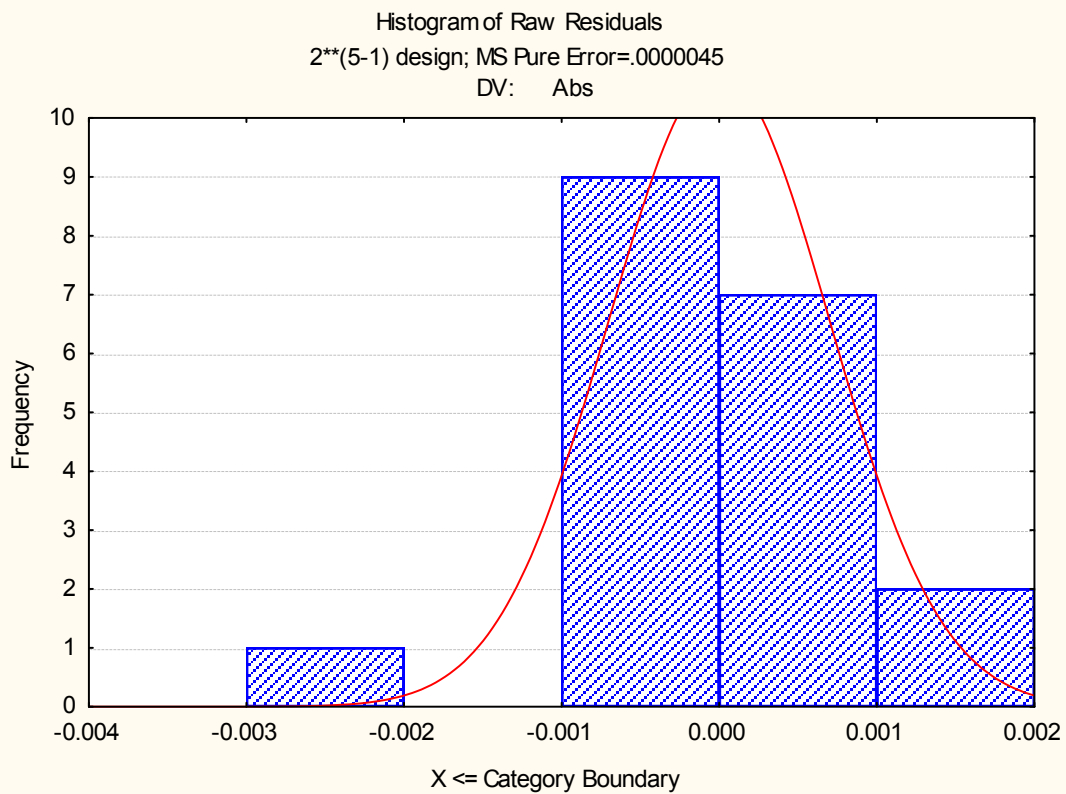

Figure 4.3 Histogram of raw residuals of the screening.

4.3.2 Response surface optimization: 5 variables

4.3.2.1 Central Composite Design

Design class: Response Surface

Design name: Draper Lin small central composite design

4.3.2.2 Base Design

Number of experimental factors: 5

Number of responses: 1

Number of runs: 25, including 3 centerpoints

Randomized: Yes

4.3.2.3 Studied range

Variable	Encoded to decoded values		
	-1	0	1
Arsenazo III volume (mL)	0.5	0.75	1
Arsenazo III concentration (%)	0.00005	0.000075	0.0001
Eluent volume (mL)	0.5	0.75	1
Eluent concentration (mol L ⁻¹)	0.01	0.055	0.1
Buffer concentration (mol L ⁻¹)	0.3	0.4	0.5

4.3.2.4 Results of the optimization

Data were fitted to a model including lineal and quadratic main effects and second way interactions. In order to evaluate the optimization results, an ANOVA table, a predicted versus observed values chart, a histogram of residuals, and desirability charts were analyzed. As can be seen in the ANOVA table (Table 4.2) the adjustment is good and the pure error is small. Besides, the profile of the histogram of residuals is almost a normal distribution (Fig. 4.5).

Although the experimental domain of optimization was changed following the screening result trends, the critical values of the variables studied are at the upper limit of the range delimited, as can be seen at the desirability charts (Fig. 4.6). However, due to limitations, such as the width of the peak obtained and the absorbance of the blank, the range of any of the variables could not be modified in that direction, so these values were accepted as

critical values for the variables of the system. Moreover the sensitivity with these conditions was more than acceptable. Thus, the critical values are shown in Table 4.3.

Table 4.2 ANOVA table of the optimization for the MSFIA-MPFS-LWCC-uranium system.

Factor	p
(1) Buffer concentration (L)	0.000379*
Buffer concentration (Q)	0.000393*
(2) Arsenazo concentration (L)	0.000192*
Arsenazo concentration (Q)	0.000667*
(3) Arsenazo volume (L)	0.000060*
Arsenazo volume (Q)	0.000335*
(4) Eluent volume (L)	0.000065*
Eluent volume (Q)	0.000607*
(5) Eluent concentration (L)	0.000110*
Eluent concentration (Q)	0.000127*
1L by 2L	0.000221*
1L by 3L	0.001742*
1L by 4L	0.000246*
1L by 5L	0.002232*
2L by 3L	0.013012*
2L by 4L	0.000174*
2L by 5L	0.001006*
3L by 4L	0.000233*
3L by 5L	0.000124*
4L by 5L	0.066065
Factor	Value
Pure error (MS)	0.0000045
R-sqr	0.99051
Adj.	0.94304

The pure error is expressed as mean square (MS).

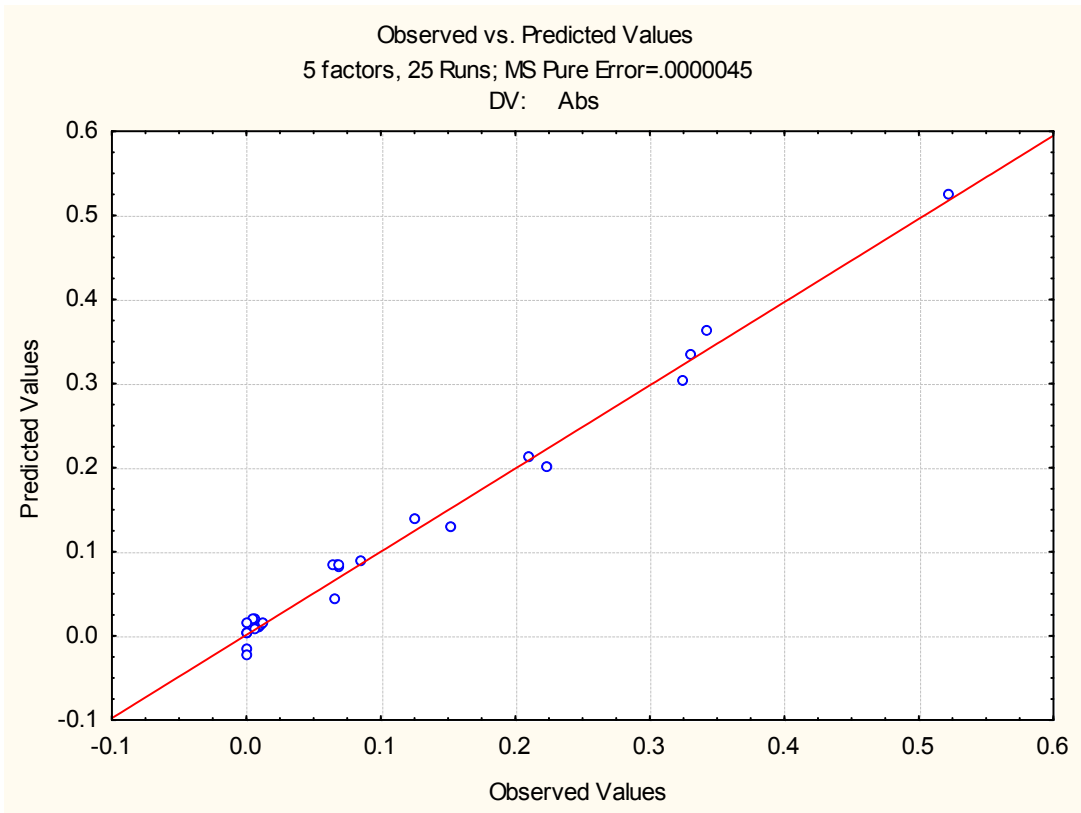

Figure 4.4 Predicted versus observed values of the optimization.

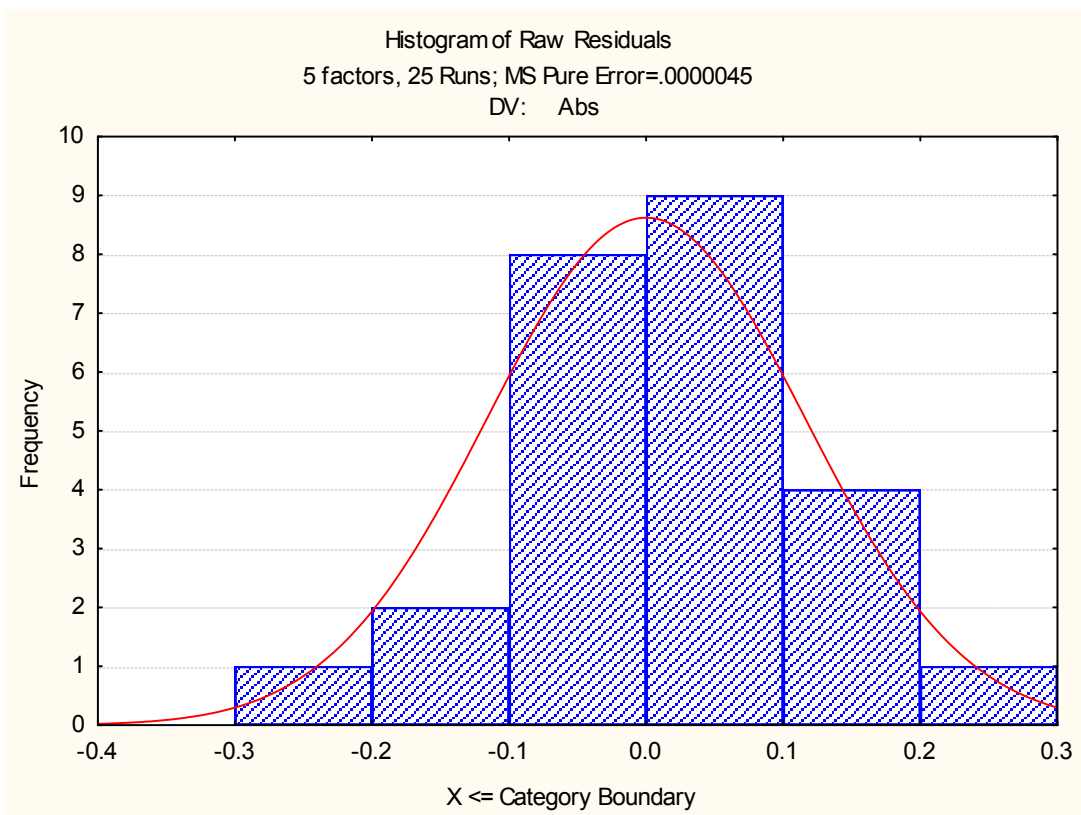

Figure 4.5 Histogram of raw residuals of the optimization.

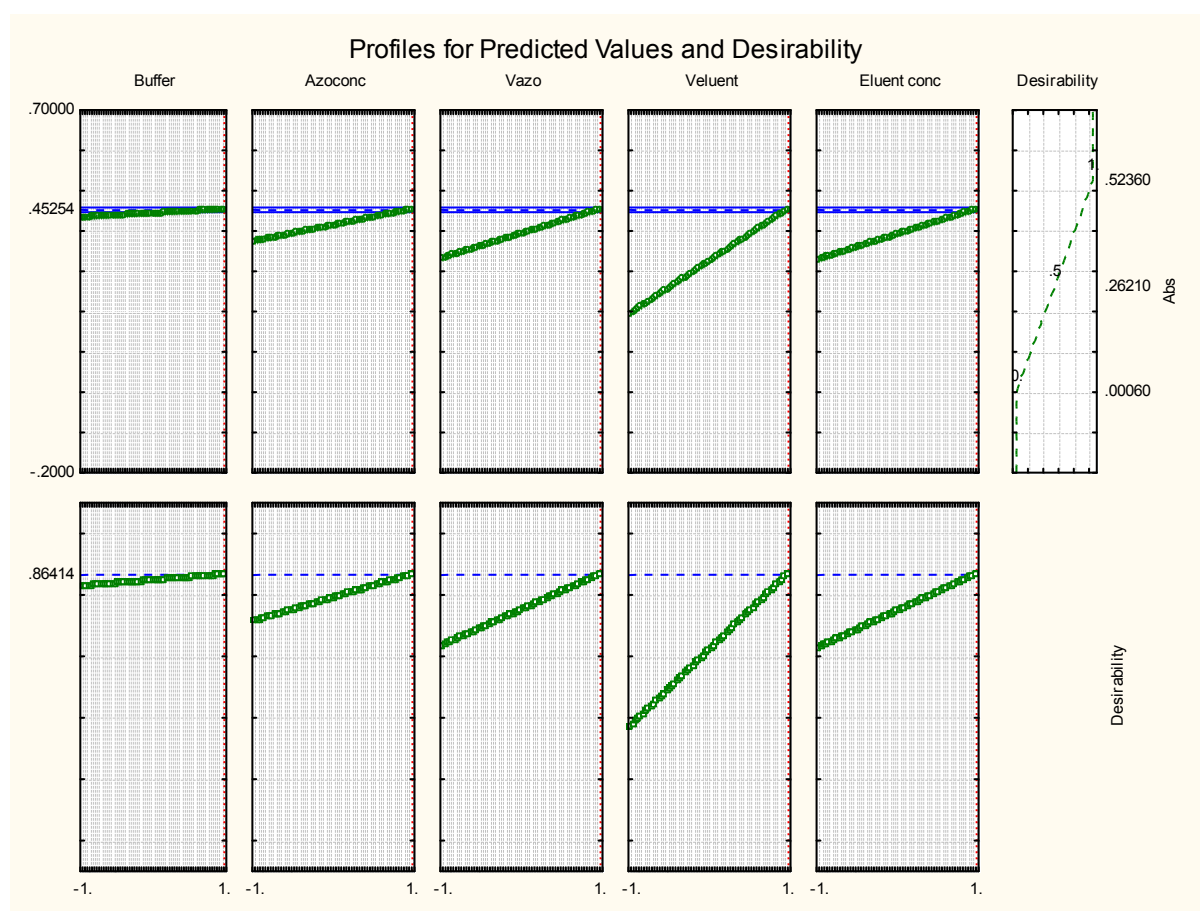

Figure 4.6 Desirability charts for the optimized variables.

Table 4.3 Critical decoded values.

Variable	Critical value
Arsenazo III concentration	0.0001%
Arsenazo III volume	1 mL
TMAH(eluent) concentration	0.1 mol L ⁻¹
TMAH(eluent) volume	1 mL
Buffer concentration	0.5 mol L ⁻¹

Chapter 5

Lab on valve-multisyringe flow injection system
(LOV-MSFIA) for fully automated uranium
determination in environmental samples

5.1 Introduction

In the work presented in this chapter, we decided to go a step forward by automating the column replacement of the SPE exploiting the LOV technique. Thus, the hyphenation of LOV and MSFIA coupled to a long path length capillary cell allowed the development of a sensitive spectrophotometric method for uranium determination in different types of environmental samples.

In table 5.1 are summarized the most relevant figures of merit of our previous developed work and the one proposed in this chapter.

Table 5.1 Comparison between the MSFIA-MPFS and the LOV-MSFIA methodologies for U determination.

Parameter	MSFIA-MPFS system	LOV-MSFIA system
Resin	TRU	UTEVA [®]
Amount of resin	80 mg	30 mg
Column replacement	manual	automatic
Resin durability	40 injections	100 injections
Preconcentration volume	100 mL	30 mL
LOD in concentration units	12.6 ng L ⁻¹	10.3 ng L ⁻¹
LOD in mass units	1.26 ng	0.31 ng
Injection throughput	0.8 - 5 h ⁻¹	1.2 - 5.5 h ⁻¹
Reproducibility (RSD, n=5)	4.9 %	1.7 %
Repeatability (RSD, n=10)	1.5 %	1.6 %
Linear working range	0 - 155 ng	0 - 300 ng

The LOD attained with both methods are remarkable, i.e. both methods are able to analyze uranium in environmental samples. Although the MSFIA-MPFS system is able to preconcentrate 100 mL, up to 3 times more volume than the LOV-MSFIA system, the LOD in concentration units of both methods are quite similar, since the LOV-MSFIA system has a better LOD in mass units, probably due to a different SPE-material is used.

The injection throughput and the repeatability are also similar in both methods. Nevertheless, the reproducibility of the LOV-MSFIA system is remarkably better than in the MSFIA-MPFS, probably due to the higher robustness of LOV technique, especially thanks to the rigid channels of the LOV.

Respect to the SPE-resin, in the LOV-MSFIA system the column replacement was satisfactorily automated, and the reduction of the resin consumption was notorious, both in the amount required which is up to three times less and in the durability, since the UTEVA[®] resin can be used up to 100 times before being replaced.

5.2 Original paper

The published paper “Lab on valve-multisyringe flow injection system (LOV-MSFIA) for fully automated uranium determination in environmental samples” by J. Avivar, L. Ferrer, M. Casas and V. Cerdà in *Talanta* 84 (2010) 1221-1227, is attached in the following pages. *Talanta* (impact factor: 3.722 year 2010) is located at the first quartile of the journals of the Analytical Chemistry area.

Supplementary information regarding to the optimization process is provided after the published paper.

5.3 Additional optimization information

In order to find the best operational conditions for separation, preconcentration and detection analysis of ultra-trace levels of uranium in the LOV-MSFIA system a series of investigations were conducted. Amongst the various parameters affecting the performance of the sorbent bead-injection preconcentration in terms of sorption efficiency for U, sample medium (HNO₃ concentration), loading flow rate and stripping conditions were optimized in previous assays.

Four potentially critical variables were taken into consideration, namely, the arsenazo-III volume, the arsenazo-III concentration, the eluent concentration and the eluent volume. The buffer concentration was optimized in previous assays (0.5 mol L⁻¹).

The computer statistics packages Statgraphics Centurion XV and Statistica 6 were used to build a multivariate two-level full factorial design to screen the variables and the interactions between them having a significant influence upon the trace element determination (analytical response) and to discard those with negligible effects on the response. Finally a response surface face centered central composite design was carried out to find the critical value of the significant variables.

The experimental design was built in a dimensionless coordinate system using factor coding, wherein the highest and lowest levels are given as +1 and -1, respectively. Three center points were included in all the designs, to identify any irregularities, such as loss of linearity in the center of the interval. Detailed information of the whole optimization process can be found below.

5.3.1 Screening Uranium in LOV-MSFIA system: 4 variables

5.3.1.1 Screening Design Attributes

Design class: Screening

Design name: Factorial 2⁴

5.3.1.2 Base Design

Number of experimental factors: 4

Number of responses: 1

Number of runs: 19, including 3 center points

Randomized: Yes

5.3.1.3 Table of the studied ranges

Variable	Encoded to decoded values		
	-1	0	1
Arsenazo III volume (mL)	0.1	0.55	1
Arsenazo III concentration (%)	0.0001	0.00055	0.001
HCl volume (mL)	0.1	0.55	1
HCl concentration (mol L ⁻¹)	0.01	0.03	0.05

5.3.1.4 Results of the screening

An ANOVA table, a Pareto chart, a fit of observed vs predicted values, and a histogram of residuals were analyzed in order to evaluate the screening results. To determine whether a variable is significant or not, the p-value is used, i.e. when the p value obtained is < 0.05, the variable is said to be statistically significant.

As can be seen in the ANOVA table (Table 5.1) and the Pareto chart (Fig. 5.1) all the studied variables and their interactions were significant into the experimental domain. Besides, the fit between the observed and predicted values showed an acceptable distribution (Fig. 5.2), and the profile of histogram was close to a normal distribution (Fig. 5.3).

Since all the variables studied and the curvature resulted significant, a response surface face centered central composite design with a total number of 27 experiments was resorted to find the critical value of the variables for the uranium determination.

Table 5.1 ANOVA table of the screening for the LOV-MSFIA-LWCC-uranium system.

Factor	p
Curvature	0.001279*
(1) HCl volume	0.000355*
(2) HCl concentration	0.002347*
(3) Arsenazo concentration	0.000009*
(4) Arsenazo volume	0.000007*
1 by 2	0.000305*
1 by 3	0.000878*
1 by 4	0.000298*
2 by 3	0.001784*
2 by 4	0.000538*
3 by 4	0.000016*
1*2*3	0.000705*
1*2*4	0.000565*
1*3*4	0.000924*
2*3*4	0.000126*
Factor	Value
Pure error (MS)	0.0000032
R-sqr	0.99618
Adj.	0.97707

The pure error is expressed as mean square (MS).

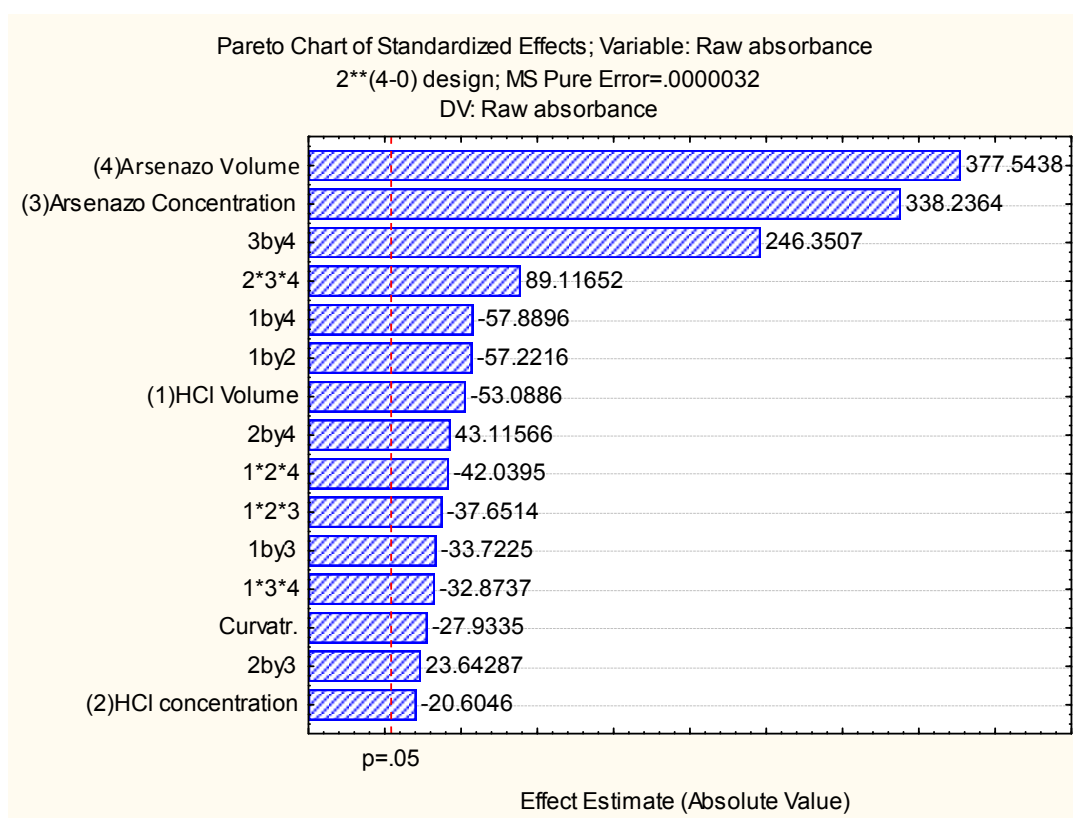

Figure 5.1 Pareto chart of the screening.

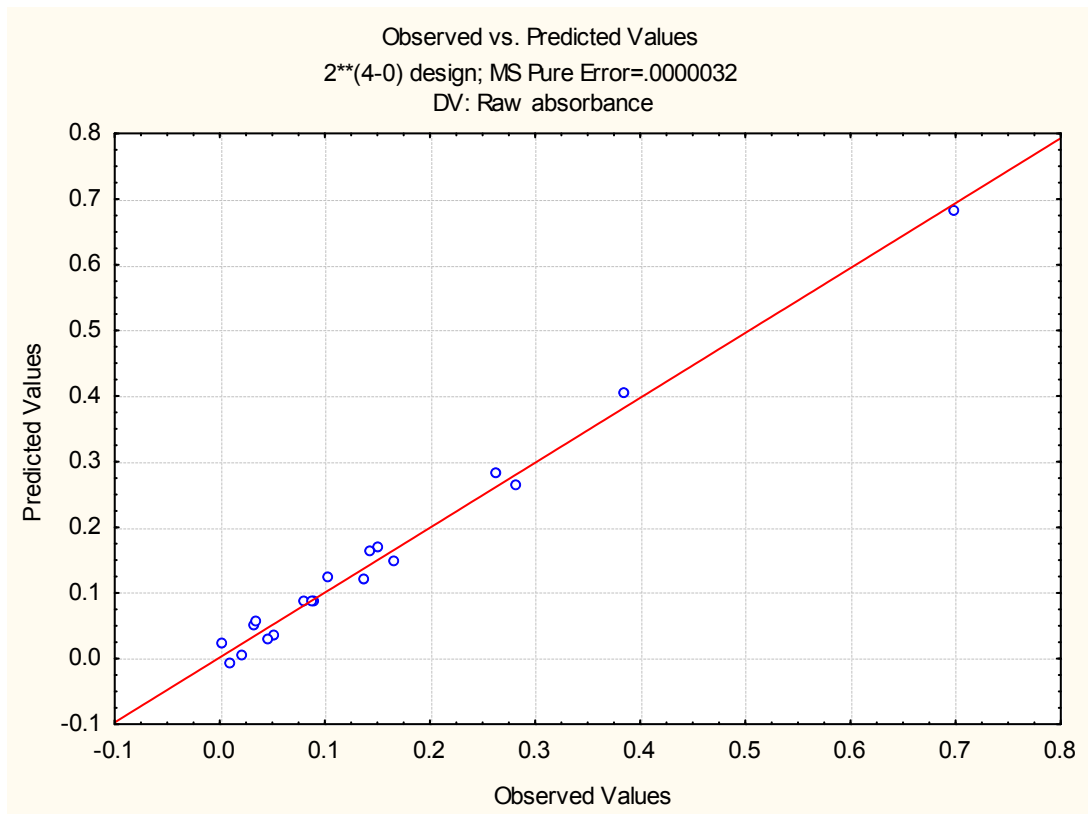

Figure 5.2 Fit between observed and predicted values of the screening.

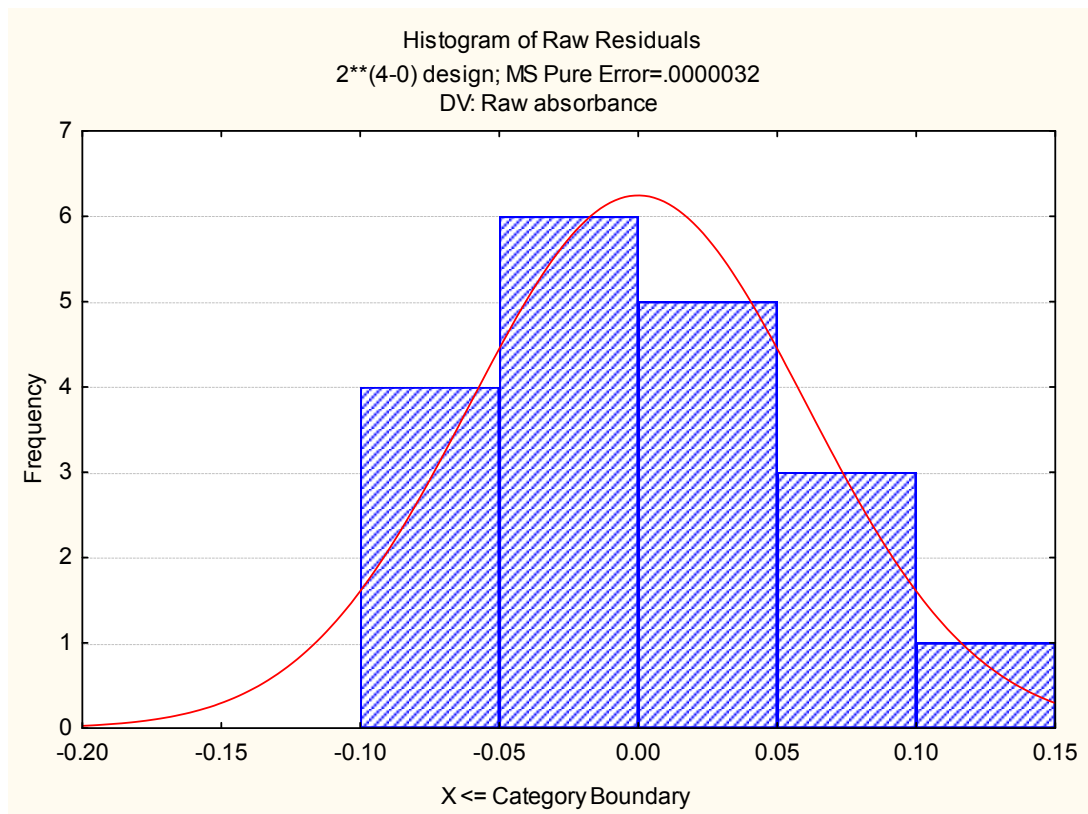

Figure 5.3 Histogram of raw residuals of the screening.

5.3.2 Response surface optimization: 4 variables

5.3.2.1 Response Surface Design Attributes

Design class: Response Surface

Design name: Central composite design: 2^4 + star

Design characteristic: Face centered

5.3.2.2 Base Design

Number of experimental factors: 4

Number of responses: 1

Number of runs: 27, including 3 centerpoints

Randomized: Yes

5.3.2.3 Table of the studied ranges

Variable	Encoded to decoded values		
	-1	0	1
Arsenazo III volume (mL)	0.1	0.55	1
Arsenazo III concentration (%)	0.0001	0.0007	0.0015
HCl volume (mL)	0.1	0.55	1
HCl concentration (mol L ⁻¹)	0.01	0.03	0.05

5.3.2.4 Results of the optimization

Data were fitted to a model including lineal and quadratic main effects and second way interactions. In order to evaluate the optimization results, an ANOVA table, a fit of observed vs predicted values, a histogram of residuals, and desirability charts were analyzed. As can be seen in the ANOVA table (Table 5.2) all the studied variables and some of their interactions were significant into the experimental domain. Although the fit between the observed and predicted values showed a poor distribution (Fig. 5.4), the adjust coefficient was satisfactory. Besides, the profile of the histogram of raw residuals showed a normal distribution (Fig. 5.5).

Since the arsenazo-III (blank signal) also absorbs at 660 nm, the desirability function was used to select the critical values in order to reach a compromise between the minimal blank signal and the maximum absorbance. As can be seen at the desirability charts (Fig.

5.6), the critical values of the HCl volume and concentration, and arsenazo volume variables are at the limit of the range delimited. The volume ranges of the HCl and arsenazo-III were not modified in order to avoid peaks too wide. So these values were accepted as critical values for the variables of the system. Moreover the sensitivity with these conditions was more than acceptable. Thus, the established critical values are shown in Table 5.3.

Table 5.2 ANOVA table of optimization results for LOV-MSFIA-LWCC-uranium system.

Factor	p
(1) HCl concentration (L)	0.000387*
HCl concentration (Q)	0.014903*
(2) HCl volume (L)	0.000819*
HCl volume (Q)	0.000076*
(3) Arsenazo concentration (L)	0.000008*
Arsenazo concentration (Q)	0.000452*
(4) Arsenazo volume (L)	0.000007*
Arsenazovolume (Q)	0.000463*
1L by 2L	0.000305*
1L by 3L	0.000878*
1L by 4L	0.000298*
2L by 3L	0.001784*
2L by 4L	0.000538*
3L by 4L	0.000016*
Factor	Value
Pure error (MS)	0.0000032
R-sqr	0.95435
Adj.	0.90109

The pure error is expressed as mean square (MS).

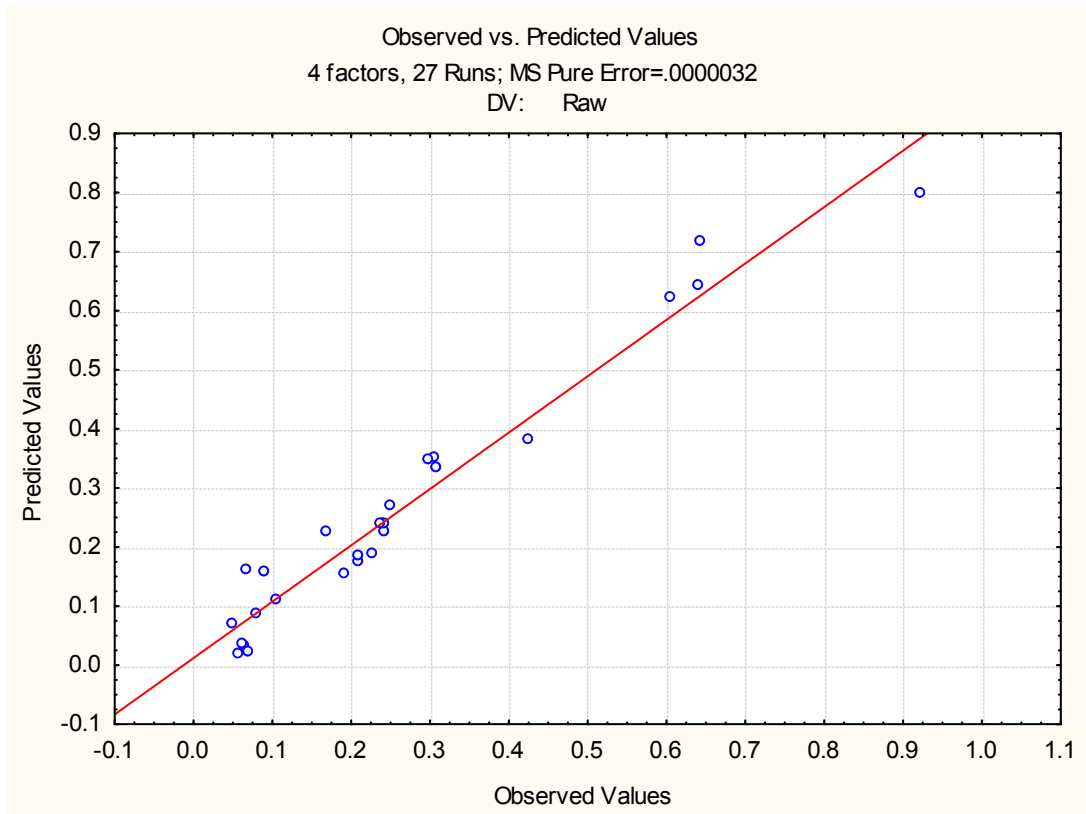

Figure 5.4 Fit between observed and predicted values of the optimization.

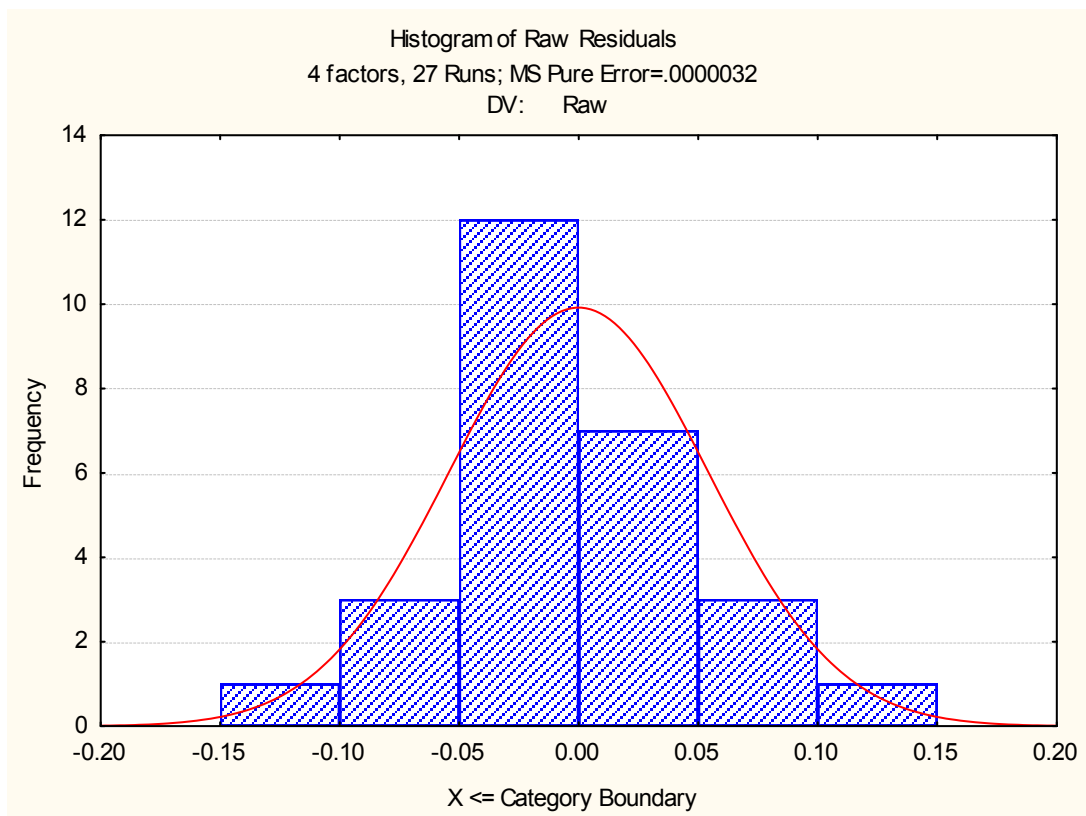

Figure 5.5 Histogram of raw residuals of the optimization.

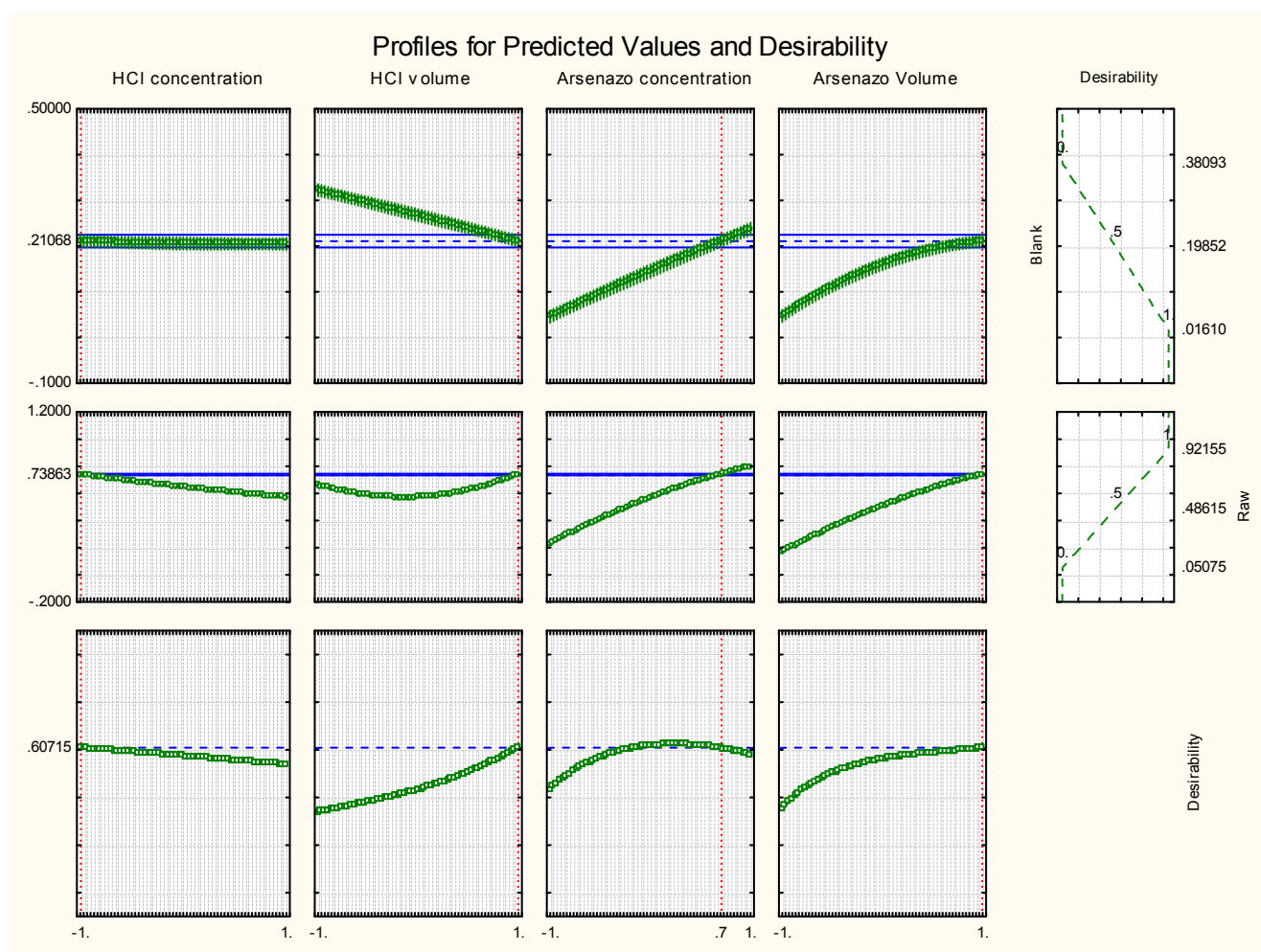

Figure 5.6 Desirability charts for optimized variables.

Table 5.3 Critical decoded values.

Variable	Critical value
Arsenazo III concentration	0.001%
Arsenazo III volume	1 mL
HCl(eluent) concentration	0.01 mol L ⁻¹
HCl(eluent) volume	1 mL
Buffer concentration*	0.5 mol L ⁻¹

*The buffer concentration was optimized in preliminary studies.

Chapter 6

Smart thorium and uranium determination
exploiting renewable solid-phase extraction
applied to environmental samples in a wide
concentration range

6.1 Introduction

This chapter presents a work in which, the grade of automation and the number of analytes to be determined have been upgraded. Thus, a smart, fully automated, multiparametric, low-cost, robust, portable and rapid analyzer for total thorium and uranium determination in environmental samples is presented. The hyphenation of MSFIA and LOV coupled to a LWCC make of this system a powerful tool for a rapid screening of thorium and uranium in environmental samples, thanks to the multiparametric capabilities of the LOV, allowing the analysis in a wide range of concentrations for both elements.

The main achievement of this work is the total automation provided by the design of a smart system capable of taking decisions by itself and of choosing the best strategy to quantify the analytes, which provides more autonomy to the designed analyzer and distinguish it from previous developed approaches in which the presence of the analyst was unavoidable. Many methods proposed in the literature as fully automated approaches can not be considered so, since an automated device is conceived to make decisions by itself with the help of feedback tools without human intervention¹. The incorporation of feedback mechanisms in the control software increases the possibilities within the system and is a step forward in automation. A tree structure of choice statements, described in terms of conditionals, such as "If" A occurs, "Then" B follows is used in the developed system to adapt itself to select the direct, preconcentrated or diluted determination of the analytes. Thus, the proposed system is able to work autonomously determining uranium and thorium in environmental samples with unknown concentrations of these elements. All this was possible thanks to the high versatility of the software AutoAnalysis. Moreover, the versatility of the MSFIA-LOV system developed allowed the sequential determination of thorium and uranium.

Other figures of merit of this method should also be highlighted, such as the limits of detection (LOD) achieved, 5.9 and 60 ng L⁻¹, for uranium and thorium, respectively, which are lower than those obtained with radiometric detection and similar to other methods using ICP-MS. These LODs reach the present limit levels established for uranium in drinking waters by the WHO. Other great features of this system are the wide working ranges for both analytes, provided by the use of UTEVA[®] resin which allows dilution, preconcentration and direct determination of the analytes of interest.

Moreover, this methodology was evaluated by analyzing five different water matrixes (fresh water, mineral water, tap water, well water and seawater), and a channel sediment reference material.

¹ M. Valcárcel, M.D. Luque de Castro. Automatic methods of analysis, Elsevier, Amsterdam, 1988.

6.2 Original paper

The published paper “Smart thorium and uranium determination exploiting renewable solid-phase extraction applied to environmental samples in a wide concentration range” by J. Avivar, L. Ferrer, M. Casas and V. Cerdà in *Analytical and Bioanalytical Chemistry* 400 (2011) 3585-3594, is attached in the following pages. The journal *Analytical and Bioanalytical Chemistry* (impact factor: 3.841 year 2010) is located at the first quartile of the journals of the Analytical Chemistry area.

Supplementary information regarding to the optimization process is provided after the published paper.

6.3 Additional optimization information

In order to find the best operational conditions for separation, preconcentration and detection of thorium and uranium in the smart LOV-MSFIA system a series of investigations were conducted. Amongst the various parameters affecting the performance of the sorbent bead-injection preconcentration in terms of sorption efficiency for U and Th, sample medium, loading flow rate and stripping conditions were optimized in previous assays.

Since Th and U were eluted sequentially, and Th was eluted firstly, we decided to optimize Th and then U. Four potentially critical variables were taken into consideration, namely, the arsenazo-III volume, the arsenazo-III concentration, the eluent concentration and the eluent volume. Besides, tolerance to potential interfering species was investigated.

The computer statistics packages Statgraphics Centurion XV and Statistica 6 were used to build a multivariate two-level full factorial design to screen the variables and the interactions between them having a significant influence upon the trace element determination (analytical response) and to discard those with negligible effects on the response. Finally a response surface face centered central composite design was carried out to find the critical value of the significant variables.

The experimental design was built in a dimensionless coordinate system using factor coding, wherein the highest and lowest levels are given as +1 and -1, respectively. Three center points were included in all the designs, to identify any irregularities, such as loss of linearity in the center of the interval. Detailed information of the whole optimization process can be found below.

6.3.1 Screening Thorium in Smart Th-U determination: 4 variables

6.3.1.1 Screening Design Attributes

Design class: Screening

Design name: Factorial 2^4

6.3.1.2 Base Design

Number of experimental factors: 4

Number of responses: 1

Number of runs: 19, including 3 centerpoints

Randomized: Yes

6.3.1.3 Table of the studied ranges

Variable	Encoded to decoded values		
	-1	0	1
Arsenazo III volume (mL)	0.1	0.4	0.7
Arsenazo III concentration (%)	0.0001	0.0003	0.0005
HCl volume (mL)	1	1.5	2
HCl concentration (mol L ⁻¹)	5	5.5	6

6.3.1.4 Results of the screening Th

In order to evaluate the screening results, an ANOVA table, a Pareto chart, a fit of observed vs predicted values, and a histogram of residuals were analyzed. To determine whether a variable is significant, the p-value is used ($p < 0.05$), the variable is said to be statistically significant (marked with an asterisk at the ANOVA table, table 6.1).

As can be seen at the Pareto chart (Fig. 6.1) and at the ANOVA table, the curvature, the volume and the concentration of arsenazo are significant variables into the studied range, so these two variables will be optimized in a response surface design. However, the concentration and volume of hydrochloric acid are not significant variables in the studied range, so the minimum value of these will be taken as optimal for further investigations, because their contribution is negative so the lower they are the better the signal will be.

The fit between the observed and predicted values showed a good distribution (Fig. 6.2), and the profile of the histogram was close to a normal distribution (Fig. 6.3)

Table 6.1 ANOVA table of the screening for the smart LOV-MSFIA system.

Factor	p
Curvature	0.001761*
(A)Arsenazo volume	0.000451*
(B)Arsenazo concentration	0.000169*
(C)Eluent volume	0.072356
(D)Eluent concentration	0.924167
A by B	0.000692*
A by C	0.610236
A by D	0.932711
B by C	0.710220
B by D	0.862140
C by D	0.909966
Factor	Value
Pure error (MS)	0.0001518
R-sqr	0.98485
Adj.	0.96104

The pure error is expressed as mean square (MS).

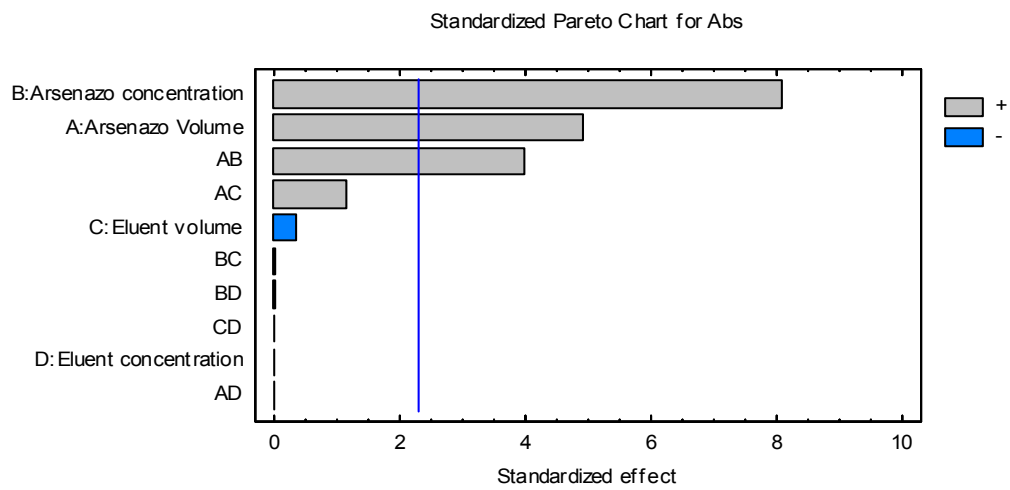

Figure 6.1 Pareto chart of the screening.

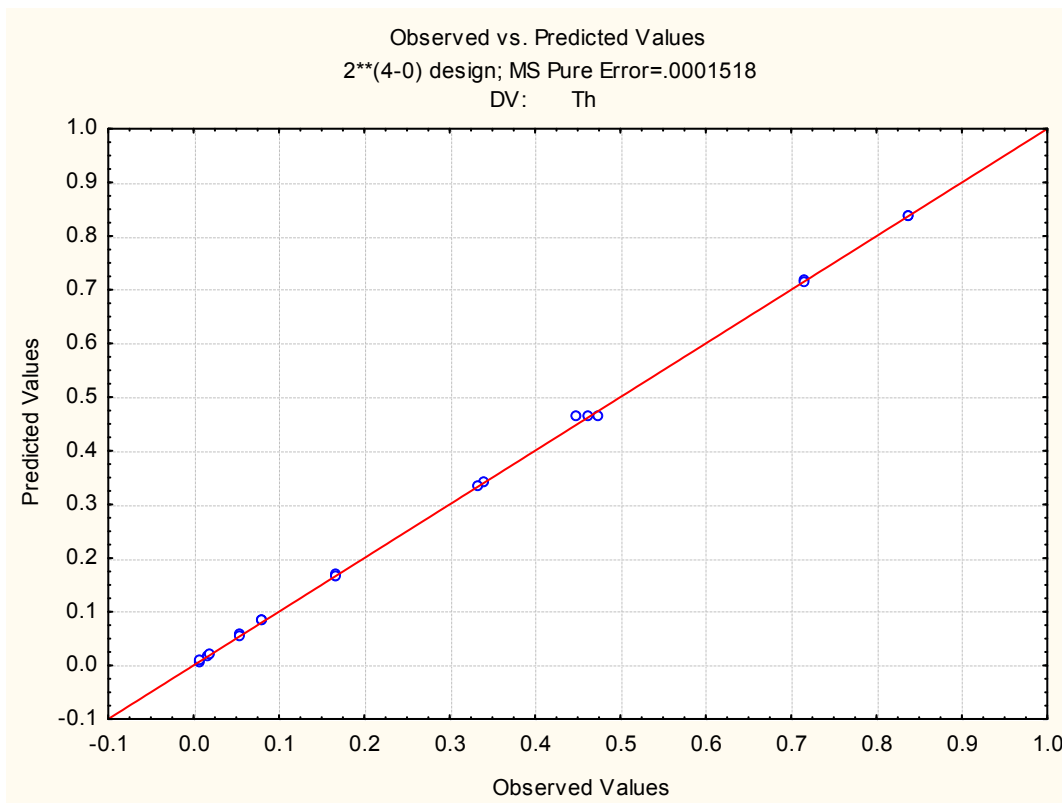

Figure 6.2 Predicted versus observed values chart

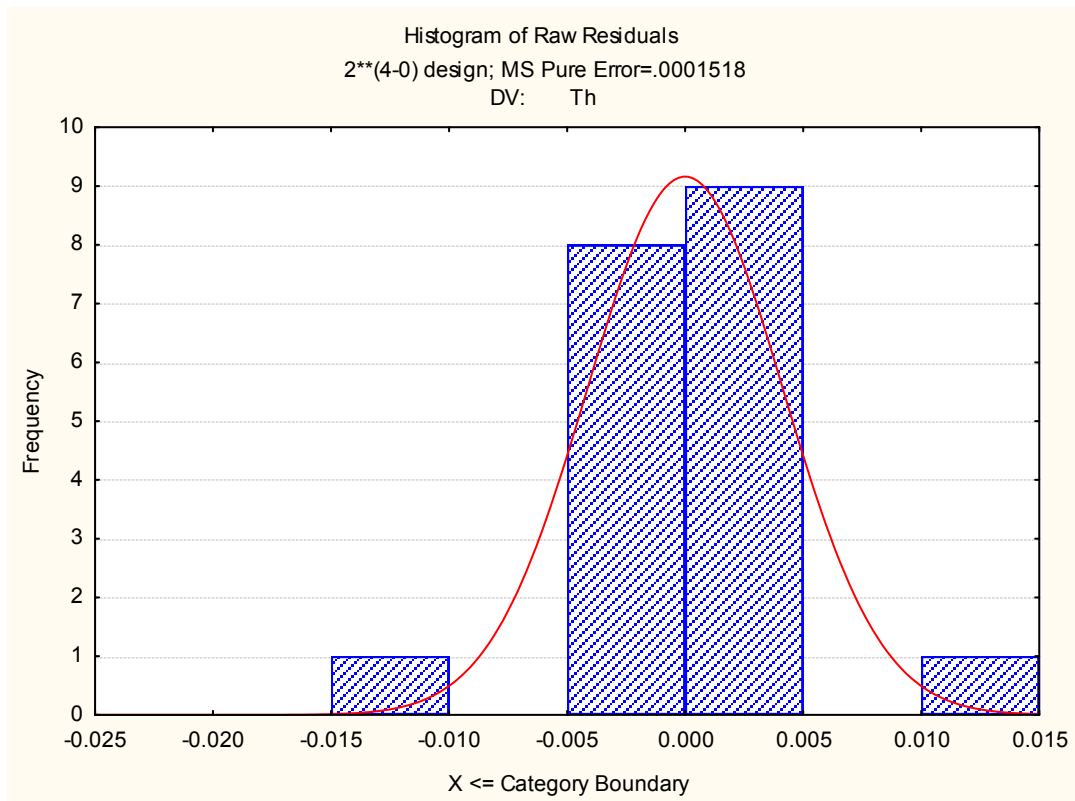

Figure 6.3 Histogram of raw residuals chart.

6.3.2 Response surface optimization Th: 2 variables

6.3.2.1 Central Composite Design

Design class: Response Surface

Design name: Central composite design: $2^2 + \text{star}$

Design characteristic: Face centered

6.3.2.2 Base design

Factors: 2 Replicates: 1

Base runs: 11 Total runs: 11

Two-level factorial: Full factorial

Cube points: 4 Center points in cube: 3

Axial points: 4 Center points in axial: 0

6.3.2.3 Table of the studied ranges

Variable	Encoded to decoded values		
	-1	0	1
Arsenazo III volume (mL)	0.1	0.55	1
Arsenazo III concentration (%)	0.0001	0.00055	0.001

6.3.2.4 Results of the optimization

Data were fitted to a model including lineal and quadratic main effects and second way interactions. In order to evaluate the optimization results, an ANOVA table, a predicted versus observed values chart (Fig. 6.4), a histogram of residuals (Fig. 6.5), and desirability charts (Fig. 6.6) were analyzed. Since the arsenazo-III also absorbs at 660 nm, the desirability function was used to select the critical values in order to reach a compromise between the minimal blank signal and the maximum absorbance.

As can be seen in the ANOVA table (Table 6.2) the adjustment is quite good and the pure error is quite small. Although the fit between the observed and predicted values showed a poor distribution, the profile of the histogram of residuals is acceptable (Fig. 6.5).

Table 6.2 ANOVA table of the optimization for the smart LOV-MSFIA system.

Factor	p
(A) Arsenazo volume (L)	0.000077*
Arsenazo volume (Q)	0.000082*
(B) Arsenazo concentration (L)	0.000014*
Arsenazo concentration (Q)	0.000458*
AL by BL	0.000241*
Factor	Value
Pure error (MS)	0.0000122
R-sqr	0.93234
Adj.	0.86468

The pure error is expressed as mean square (MS).

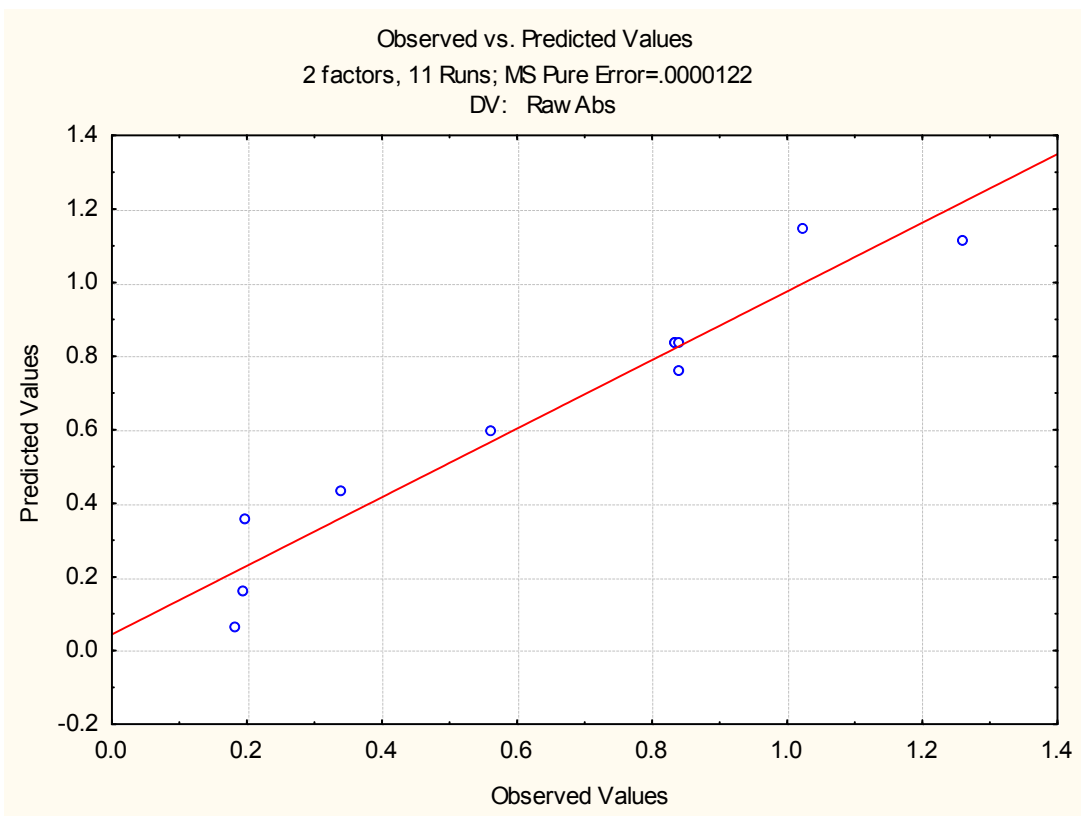

Figure 6.4 Predicted versus observed values of the optimization.

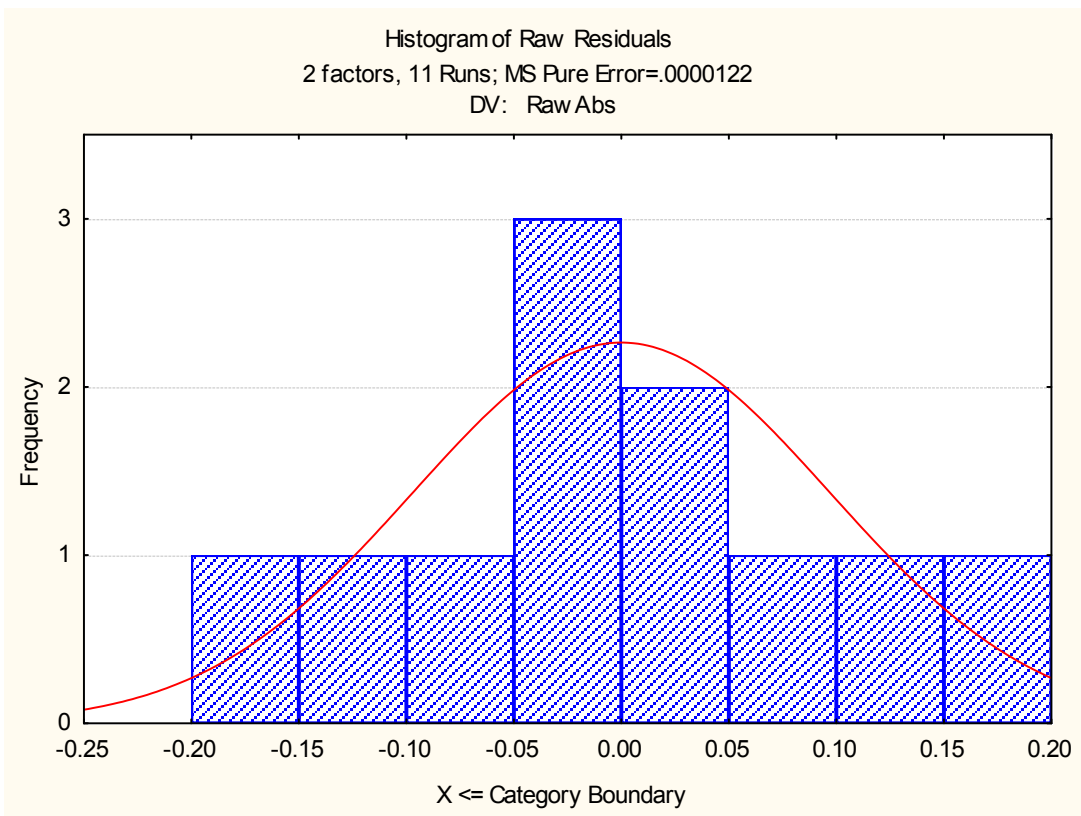

Figure 6.5 Histogram of raw residuals of the optimization.

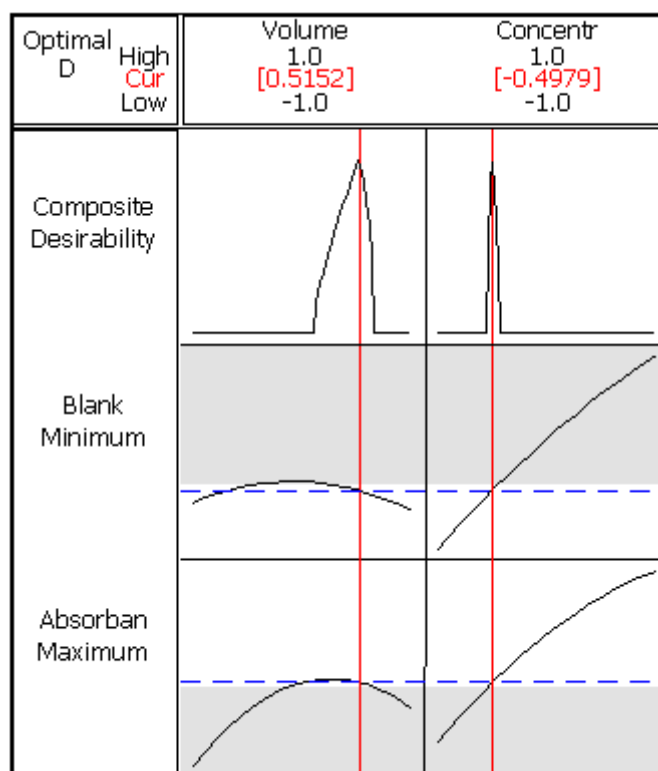

Figure 6.6 Desirability charts for the optimized variables.

Table 6.3 Critical decoded values.

Variable	Critical value
Arsenazo III concentration	0.00035%
Arsenazo III volume	0.75 mL
HCl(eluent) concentration	5 mol L ⁻¹
HCl(eluent) volume	1 mL

6.3.3 Screening Uranium in Smart Th-U determination: 4 variables

6.3.3.1 Screening Design Attributes

Design class: Screening

Design name: Factorial 2⁴

6.3.3.2 Base Design

Number of experimental factors: 4

Number of responses: 1

Number of runs: 19, including 3 center points

Randomized: Yes

6.3.3.3 Table of studied ranges

Variable	Encoded to decoded values		
	-1	0	1
Arsenazo III volume (mL)	0.1	0.4	0.7
Arsenazo III concentration (%)	0.0001	0.00055	0.001
HCl volume (mL)	0.1	0.55	1
HCl concentration (mol L ⁻¹)	0.03	0.04	0.05

6.3.3.4 Results of the U screening

As can be seen at the Pareto chart (Fig. 6.7) and at the ANOVA table (Table 6.4), the volume and the concentration of arsenazo are significant variables in the studied range. Although the volume and the concentration of hydrochloric acid are not significant variables we decided to include them in the response surface optimization design, since they show interaction between them (Fig. 6.8). The predicted versus observed values chart (Fig. 6.9) and the histogram of raw residuals (Fig. 6.10) were acceptable.

Table 6.4 ANOVA table for the screening of U in the smart LOV-MSFIA system.

Factor	p
Curvature	0.002741*
(A) HCl volume	0.244620
(B)HCl concentration	0.639315
(C)Arsenazo concentration	0.000009*
(D)Arsenazo volume	0.000007*
A by B	0.213035
A by C	0.448127
A by D	0.208215
B by C	0.591236
B by D	0.337548
C by D	0.000416*
Factor	Value
Pure error (MS)	0.0000247
R-sqr	0.95858
Adj.	0.90677

The pure error is expressed as mean square (MS).

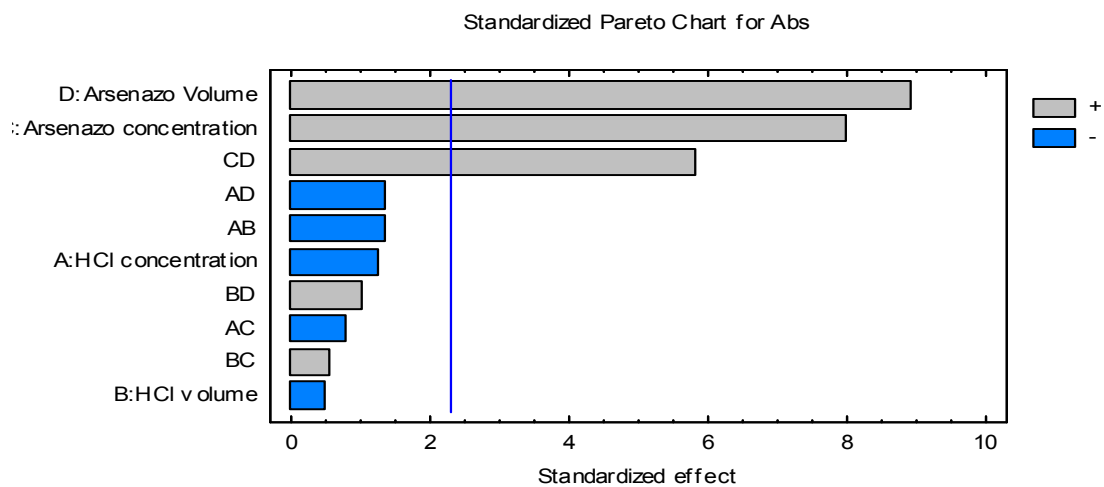

Figure 6.7 Pareto chart of the uranium screening.

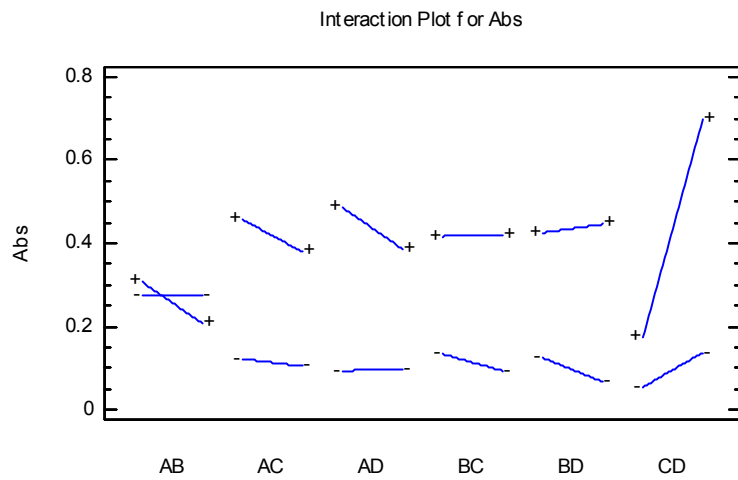

Figure 6.8 Interaction plots

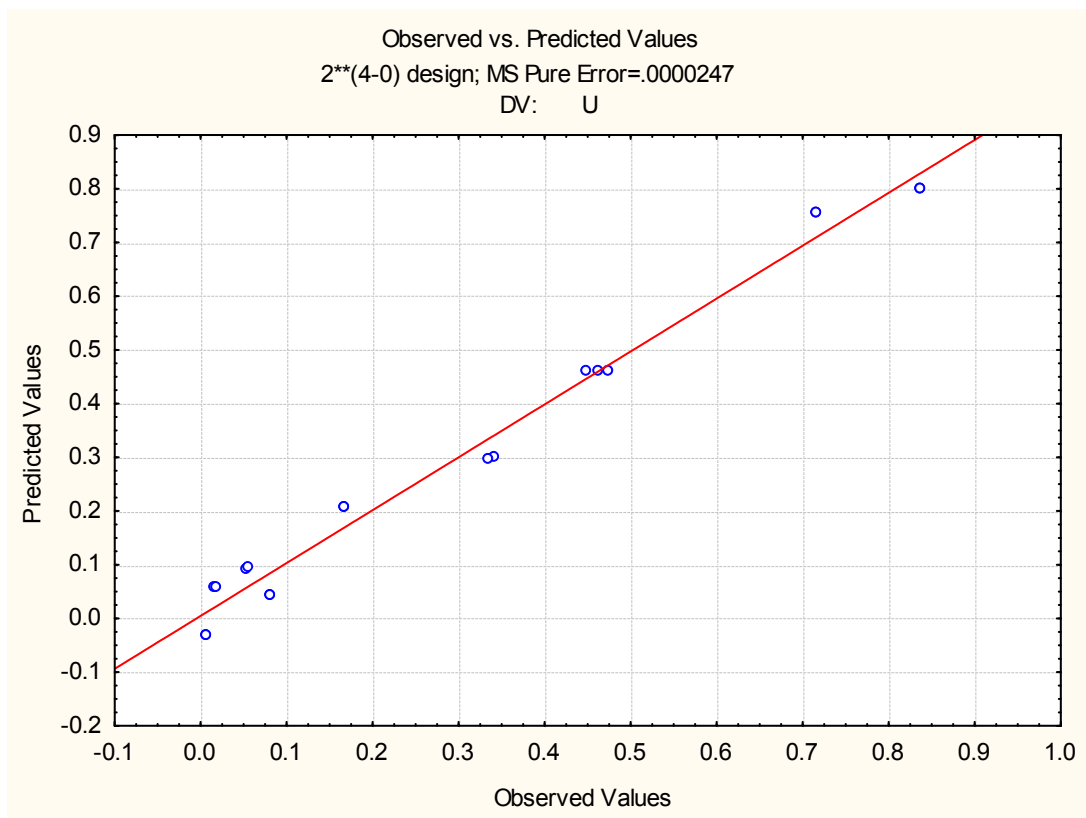

Figure 6.9 Observed versus predicted values chart of the screening.

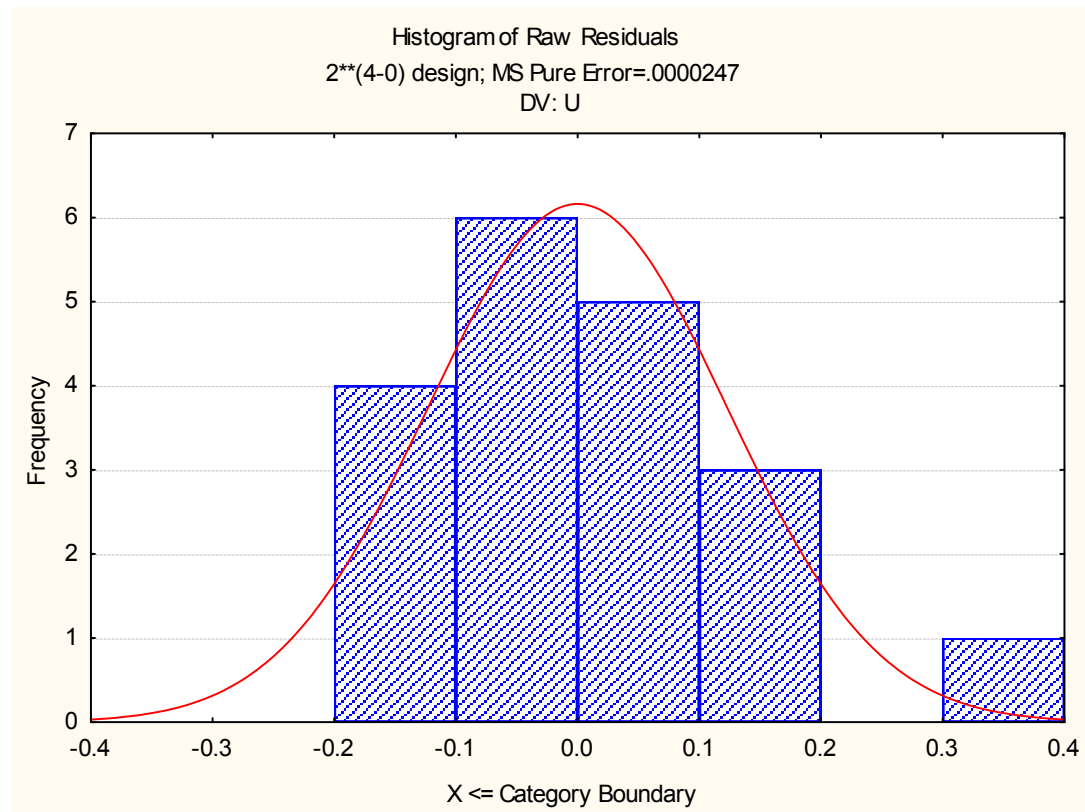

Figure 6.10 Histogram of raw residuals of the uranium screening.

6.3.4 Response surface optimization U: 4 variables

6.3.4.1 Response Surface Design Attributes

Design class: Response Surface

Design name: Central composite design: $2^4 + \text{star}$

Design characteristic: Face centered

6.3.4.2 Base Design

Number of experimental factors: 4

Number of responses: 1

Number of runs: 27, including 3 centerpoints

Randomized: Yes

6.3.4.3 Table of studied ranges

Variable	Encoded to decoded values		
	-1	0	1
Arsenazo III volume (mL)	0.1	0.55	1
Arsenazo III concentration (%)	0.0001	0.00055	0.001
HCl volume (mL)	0.1	0.55	1
HCl concentration (mol L ⁻¹)	0.01	0.03	0.05

6.3.4.4 Results of the optimization

The desirability function was also used to select the critical values in order to reach a compromise between the minimal blank signal and the maximum absorbance.

Data were fitted to a model including lineal and quadratic main effects and second way interactions. In order to evaluate the optimization results, an ANOVA table, a predicted versus observed values chart (Fig. 6.11), a histogram of residuals, and desirability charts were analyzed. As can be seen in the ANOVA table (Table 6.5) the adjustment is good and the pure error is small. Besides, the profile of the histogram of residuals is almost a normal distribution (Fig. 6.12).

Although the experimental domain of optimization was changed following the screening result trends, the critical values of the variables studied are at the upper limit of the range delimited, as can be seen at the desirability charts (Fig. 6.13). However, due to limitations, such as the width of the peak obtained and the absorbance of the blank, the range of any of the variables could not be modified in that direction, so these values were accepted as critical values for the variables of the system. Moreover the sensitivity with these conditions was more than acceptable. Thus, the critical values are shown in Table 6.6.

Table 6.5 ANOVA table of the uranium optimization in the smart LOV-MSFIA system.

Factor	p
(A) HCl concentration (L)	0.003299*
HCl concentration (Q)	0.147610
(B) HCl volume (L)	0.442696
HCl volume (Q)	0.000569*
(C) Arsenazo concentration (L)	0.000196*
Arsenazo concentration (Q)	0.004008*
(D) Arsenazo volume (L)	0.000144*
Arsenazovolume (Q)	0.022363*
AL by BL	0.221452
AL by CL	0.745630
AL by DL	0.062658
BL by CL	0.071354
BL by DL	0.085632
CL by DL	0.062463
Factor	Value
Pure error (MS)	0.0000247
R-sqr	0.97949
Adj.	0.86379

The pure error is expressed as mean square (MS).

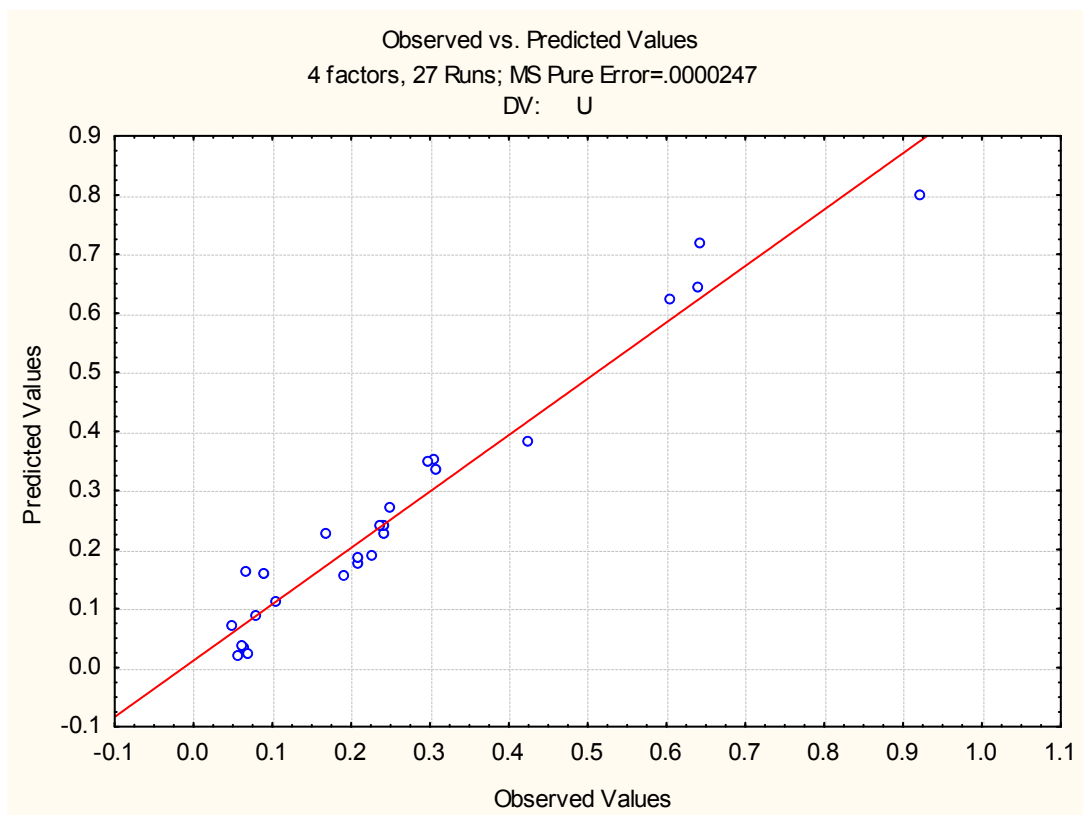
**Figure 6.11** Predicted versus observed values of the optimization.

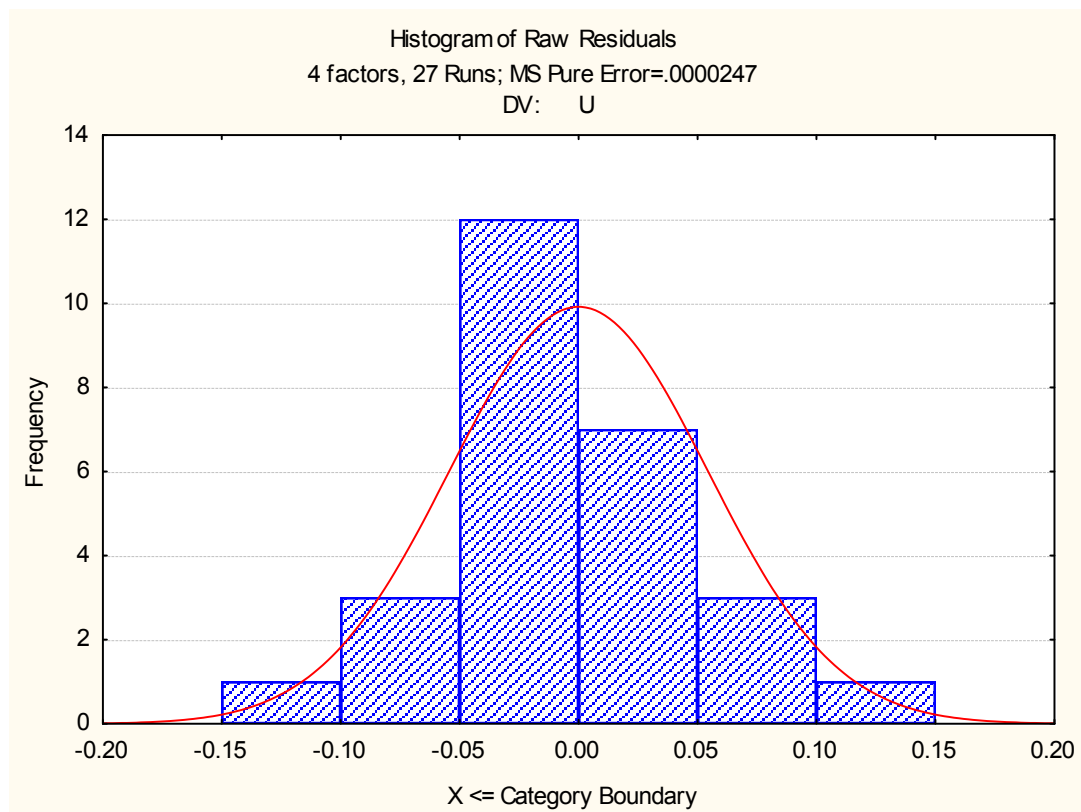

Figure 6.12 Histogram of raw residuals of the optimization.

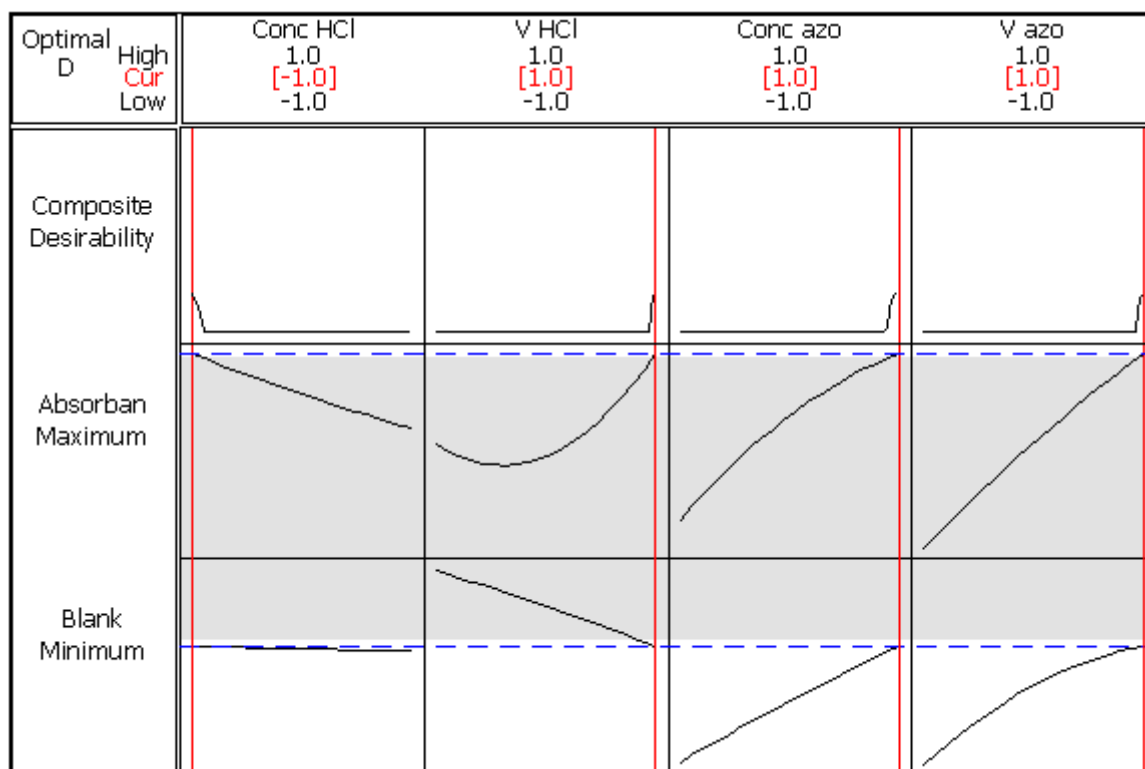

Figure 6.13 Desirability charts for the optimized variables.

Table 6.6 Decoded critical values.

Variable	Critical value
Arsenazo III concentration	0.001%
Arsenazo III volume	1 mL
HCl(eluent) concentration	0.01 mol L ⁻¹
HCl(eluent) volume	1 mL
Buffer concentration*	0.5 mol L ⁻¹

*The buffer concentration was optimized in a previous work.

Chapter 7

Fully automated LOV-MSFIA-ICP-MS system: an
effective tool for fast, sensitive and selective
determination of thorium and uranium at
environmental levels exploiting solid phase
extraction

7.1 Introduction

In this chapter, an automated multiparametric system for isotopic thorium and uranium analysis in environmental samples is presented. In this work, not only a high degree of automation is reached again thanks to the hyphenation of MSFIA and LOV, but also the isotopic analysis of both radionuclides due to the use of ICP-MS. Thus, this method is proposed as an alternative to radiometric determinations for thorium and uranium analyses at trace-levels, since it is capable of isotopic analysis in a shorter time, avoiding the large counting time required to achieve a good statistics in this type of sample when using alpha spectrometry.

Other figures of merit of this method should also be highlighted, such as the low limits of detection (LOD) achieved, 0.4 and 2.8 ng L⁻¹, for uranium and thorium, respectively, the reproducibility which is 1.7% of RSD and a high injection frequency up to 9 h⁻¹ (depending on the sample volume).

Moreover, this methodology was evaluated by analyzing five different water matrixes (fresh water, mineral water, tap water, well water and seawater), a phosphogypsum sample and a channel sediment reference material.

A mass calibration curve of the isotope ²³⁵U (Fig. 7.1) with a good fit, which was not included in the published paper, is shown below in order to demonstrate the sensitivity achieved for ²³⁵U radionuclide.

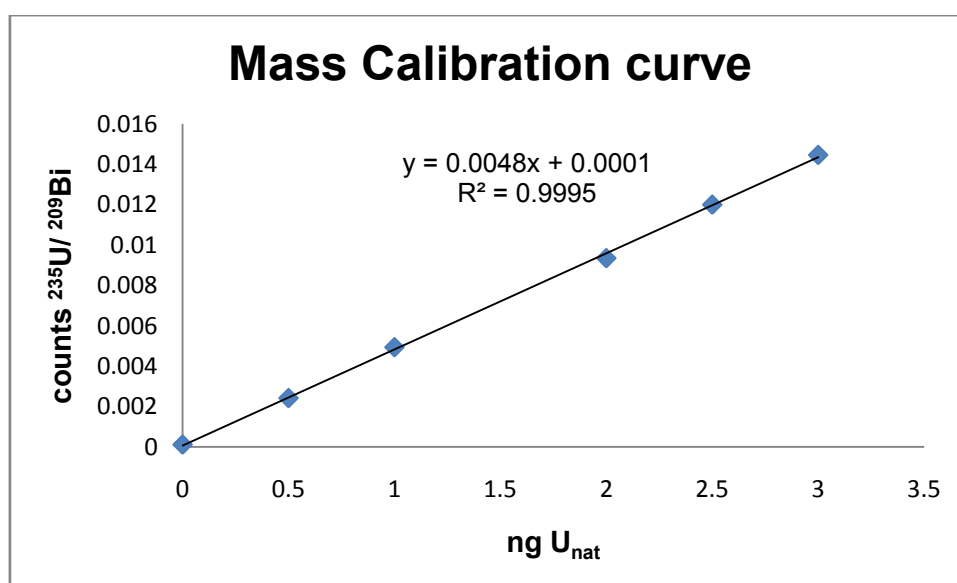

Figure 7.1 Mass calibration curve of the isotope ²³⁵U.

7.2 Original paper

The published paper “Fully automated lab-on-valve-multisyringe flow injection analysis-ICP-MS system: an effective tool for fast, sensitive and selective determination of thorium and uranium at environmental levels exploiting solid phase extraction” by J. Avivar, L. Ferrer, M. Casas and V. Cerdà in *Journal of Analytical Atomic Spectrometry* 27 (2012) 327-334, is attached in the following pages. *Journal of Analytical Atomic Spectrometry* (impact factor: 4.372 year 2010) is located at the first quartile of the journals of the Analytical Chemistry area.

Supplementary information regarding to the optimization process is provided after the published paper.

7.3 Additional optimization information

In order to find the best operational conditions for separation, preconcentration and detection analysis of ultra-trace levels of thorium and uranium in the LOV-MSFIA-ICP-MS system a series of investigations were conducted. Amongst the various parameters affecting the performance of the sorbent bead-injection preconcentration in terms of sorption efficiency for Th and U, sample medium (HNO_3 concentration), loading flow rate and stripping conditions were optimized in previous works.

Three potentially critical variables for thorium and uranium determination were taken into consideration, namely, the nitric acid concentration, the oxalic acid concentration, and the eluent volume.

The computer statistics packages Minitab 15 and Statistica 6 were used to build a multivariate two-level full factorial design to screen the variables and the interactions between them having a significant influence upon the trace elements determination (analytical response) and to discard those with negligible effects on the response. By comparing this study with the previous ones, we can immediately detect a relevant difference: since both analytes are eluted at the same time, more than one response is studied, this meaning that we must look at all of them at the same time, finding the best compromise; rather than looking for the “best” conditions. We are interested in identifying the region of the experimental domain corresponding to a product of “acceptable” quality. Inside this region the most profitable setting will be selected, in this case not because of the blank signal limitation but because we are eluting both analytes with the same eluent.

The experimental design was built in a dimensionless coordinate system using factor coding, wherein the highest and lowest levels are given as +1 and -1, respectively. A randomized complete block amounting to a total number of 11 experiments, were performed aimed at ensuring that the variability found in the response is on the account of the variables rather than the random error. Three center points were included, to identify any irregularities, such as loss of linearity in the center of the interval. Results showed that the curvature and the three variables studied were significant. Finally, a response surface face centered central composite experimental design with a total number of 17 experiments was resorted to find the critical value of the variables for the thorium and uranium determination. Detailed information of the whole optimization process can be found below.

7.3.1 Screening Uranium and Thorium in LOV-MSFIA-ICP-MS system: 3 variables

7.3.1.1 Screening Design Attributes

Design class: Screening

Design name: Factorial 2³

7.3.1.2 Base Design

Number of experimental factors: 3

Number of responses: 2

Number of runs: 11, including 3 center points

Randomized: Yes

7.3.1.3 Table of the studied ranges

Variable	Encoded to decoded values		
	-1	0	1
Oxalic acid concentration (%)	0.01	0.02	0.03
HNO ₃ concentration (mol L ⁻¹)	0.01	0.03	0.05
Eluent volume (mL)	0.1	0.3	0.5

7.3.1.4 Results of the screening

In order to evaluate the screening results, ANOVA tables, Pareto charts, fits of observed vs predicted values, and histograms of residuals were analyzed. To determine whether a variable is significant or not, the p-value is used ($p < 0.05$), the variable is said to be statistically significant (marked with an asterisk at the ANOVA tables).

As can be seen in the ANOVA tables (Table 7.1 and Table 7.2) and at the Pareto charts (Fig. 7.2 and Fig. 7.3) two of the variables studied and the interaction between the three of them resulted significant for both ²³⁸U and ²³²Th.

Moreover, the fits between the observed and predicted values showed a good distribution (Fig. 7.4 and Fig. 7.5), and the profile of histograms were close to a normal distribution (Fig. 7.6 and Fig. 7.7), despite the small number of data.

Although the curvature was not significant we decided to carry out a face centered central composite response surface in order to find the critical value of the variables for the uranium and thorium determination.

Table 7.1 ANOVA table of the screening of ^{238}U .

Factor	p
Curvature	0.086319
(1) Oxalic acid concentration	0.034639*
(2) HNO_3 concentration	0.247913
(3) Eluent volume	0.012333*
1 by 2	0.163939
1 by 3	0.121066
2 by 3	0.075967
1*2*3	0.011680*
Factor	Value
Pure error (MS)	0.0000498
R-sqr	0.99126
Adj.	0.95632

The pure error is expressed as mean square (MS).

Table 7.2 ANOVA table of the screening of ^{232}Th .

Factor	p
Curvature	0.347145
(1) Oxalic acid concentration	0.027617*
(2) HNO_3 concentration	0.211012
(3) Eluent volume	0.008482*
1 by 2	0.567002
1 by 3	0.064019
2 by 3	0.672012
1*2*3	0.033640*
Factor	Value
Pure error (MS)	0.0001101
R-sqr	0.99005
Adj.	0.95024

The pure error is expressed as mean square (MS).

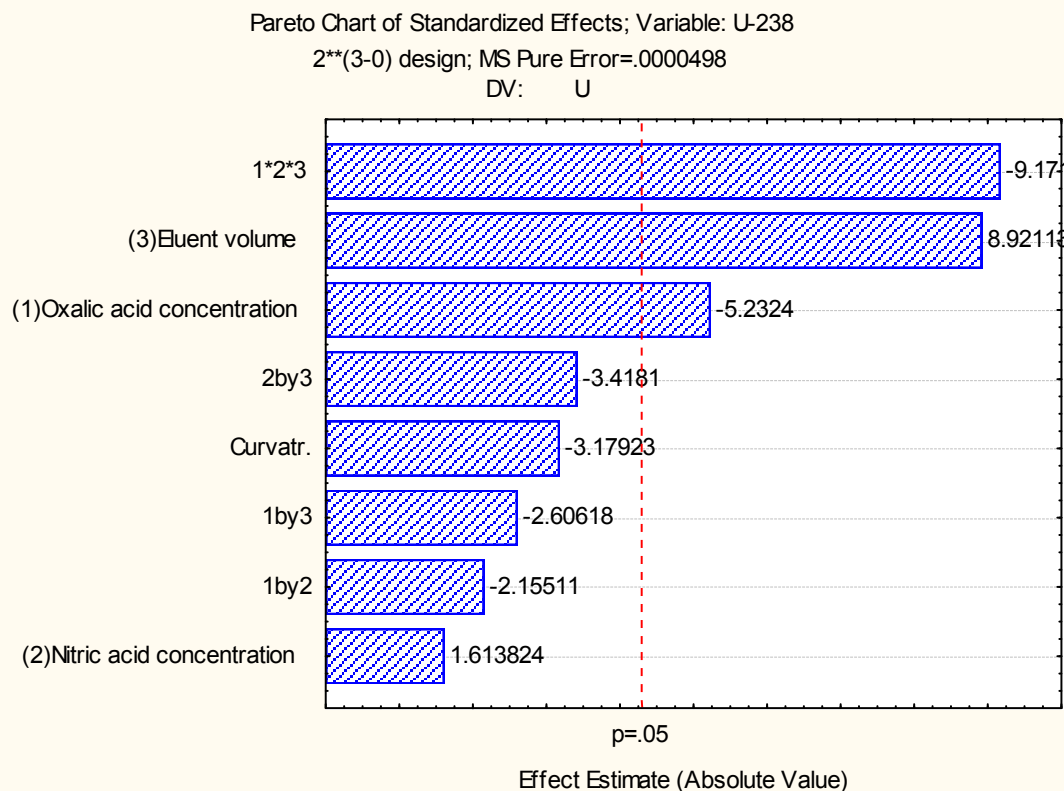

Figure 7.2 Pareto chart for the screening of ²³⁸U.

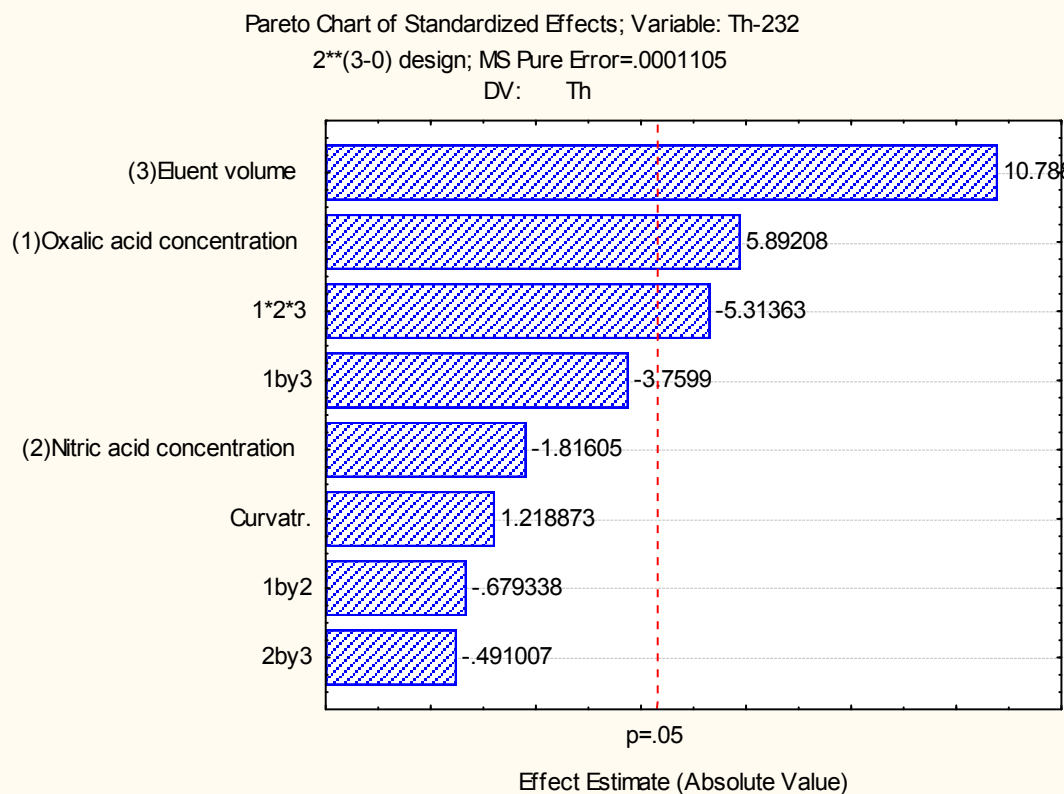

Figure 7.3 Pareto chart for the screening of ²³²Th.

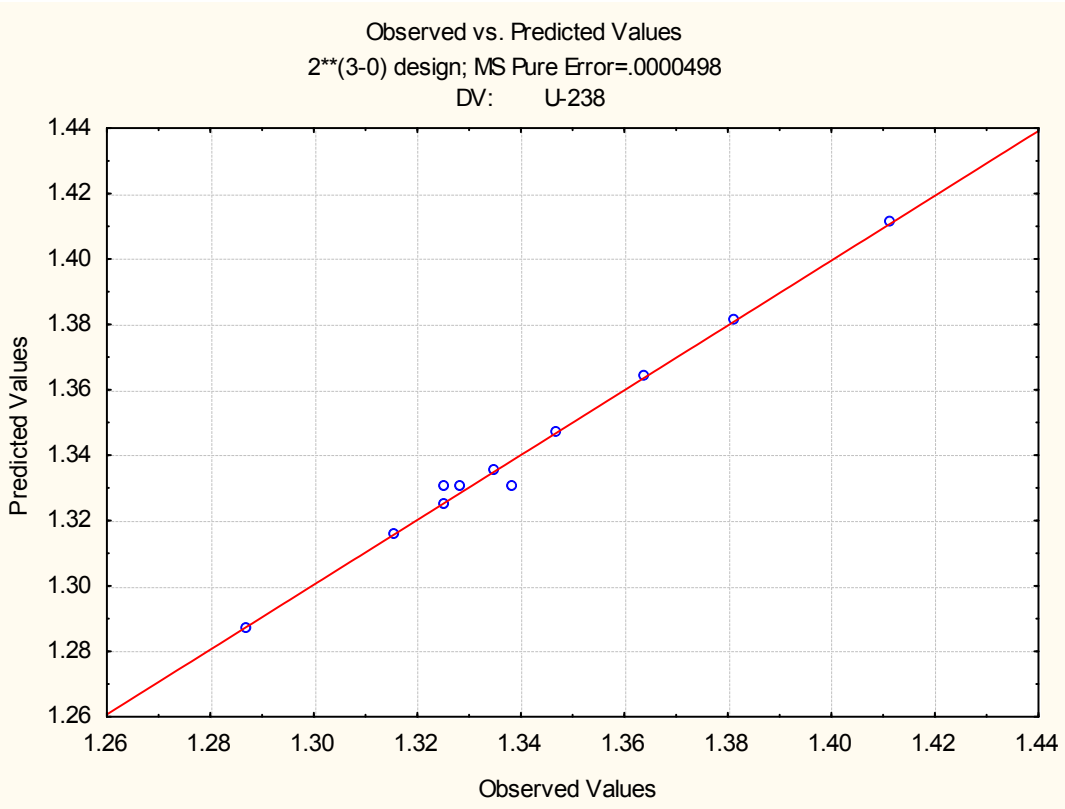

Figure 7.4 Predicted versus observed values of the screening of ²³⁸U.

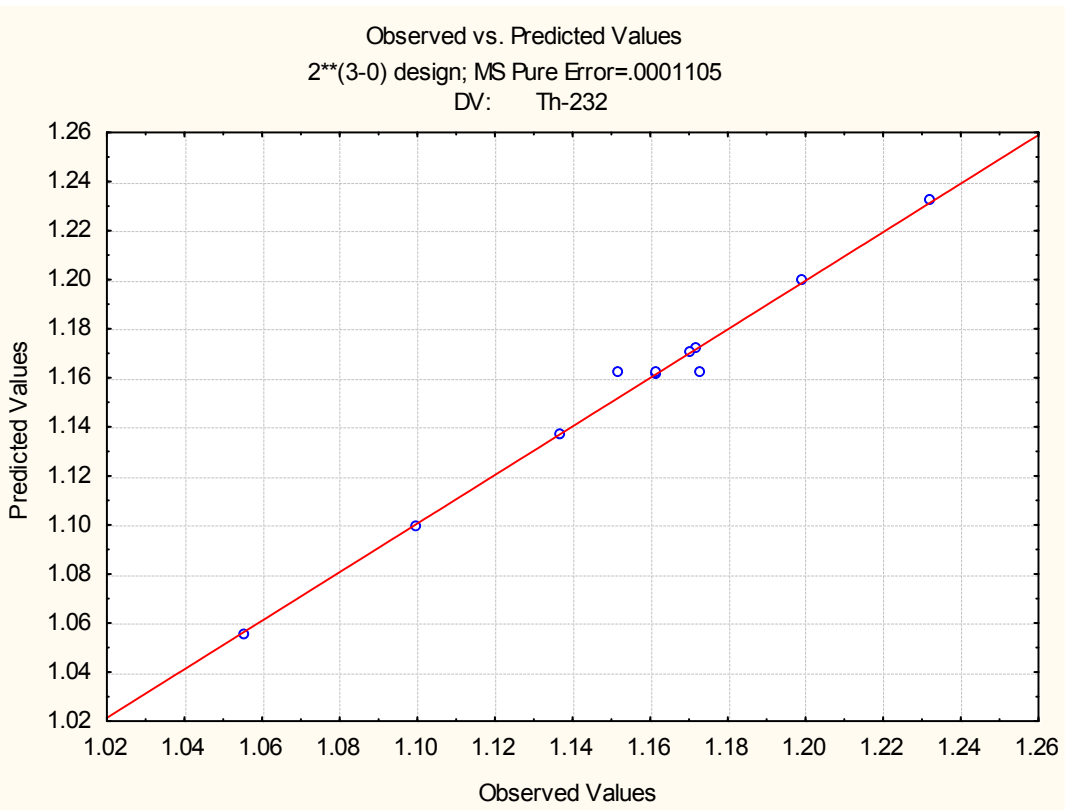

Figure 7.5 Predicted versus observed values of the screening of ²³²Th.

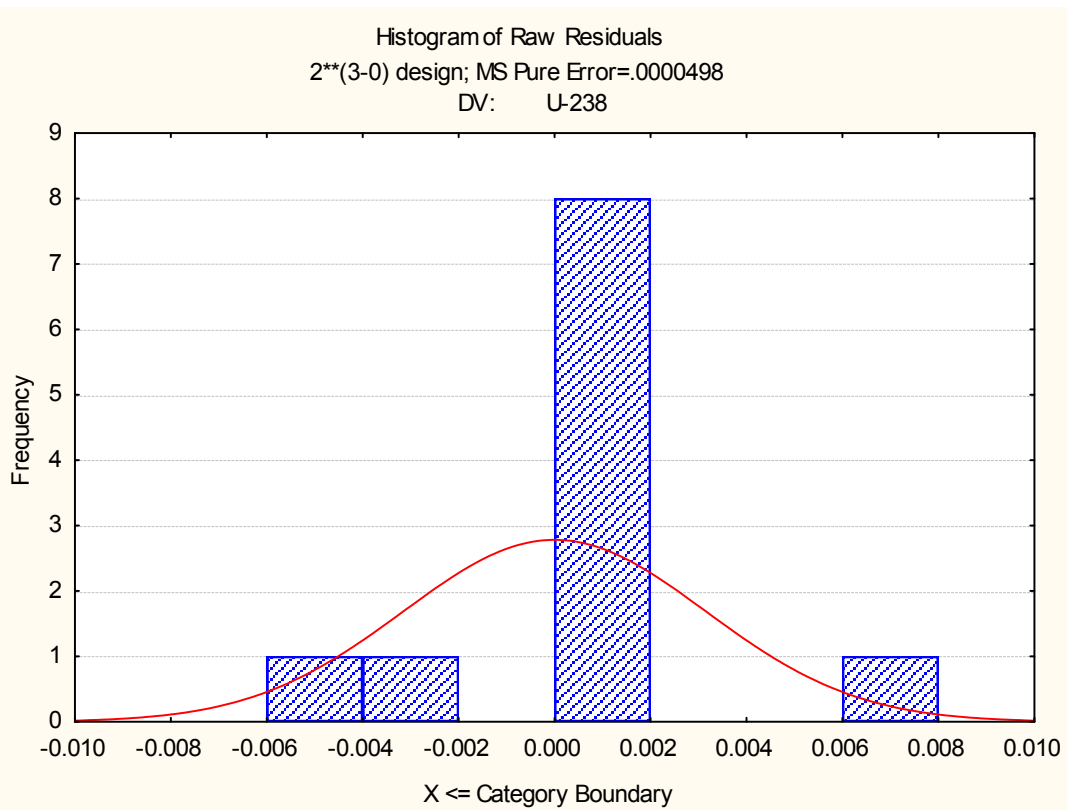

Figure 7.6 Histogram of raw residuals of the screening of ^{238}U .

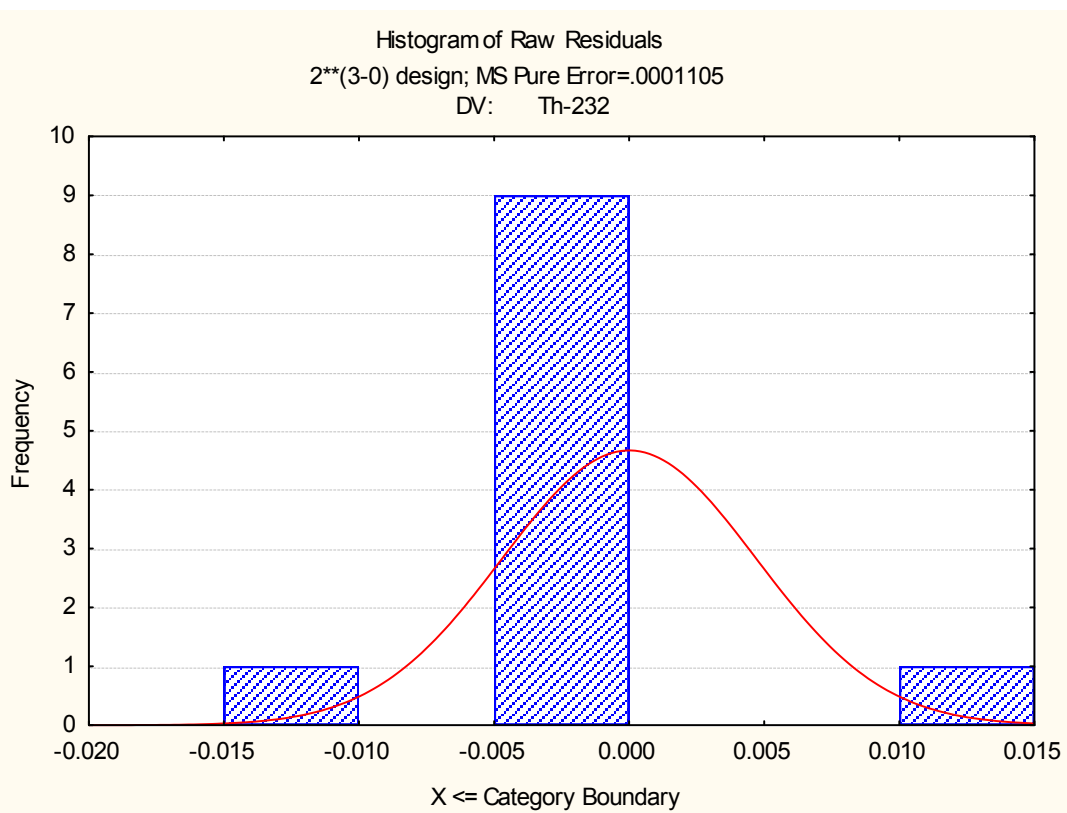

Figure 7.7 Histogram of raw residuals of the screening of ^{232}Th .

7.3.2 Response surface optimization: 3 variables

7.3.2.1 Response Surface Design Attributes

Design class: Response Surface

Design name: Central composite design: 2^3 + star

Design characteristic: Face centered

7.3.2.2 Base Design

Number of experimental factors: 3

Number of responses: 2

Number of runs: 17, including 3 centerpoints

Randomized: Yes

7.3.2.3 Table of the studied ranges

Variable	Encoded to decoded values		
	-1	0	1
Oxalic acid concentration (%)	0.01	0.03	0.05
HNO ₃ concentration (mol L ⁻¹)	0.01	0.02	0.05
Eluent volume (mL)	0.1	0.4	0.7

7.3.2.4 Results of the optimization

Data were fitted to a model including lineal and quadratic main effects and second way interactions. In order to evaluate the optimization results, ANOVA tables, predicted versus observed values charts, histograms of residuals, and desirability charts were analyzed. As can be seen in the ANOVA tables (Table 7.3 and Table 7.4) the adjustment is good for both responses and the pure error is small also for both responses. The fit between predicted versus observed values are acceptable (Fig. 7.8 and Fig. 7.9), and also the profiles of the histograms of residuals (Fig. 7.10 and Fig. 7.11).

The desirability function (Fig. 7.12) was used to select the critical values in order to reach a maximum signal for both analytes within the same stripping conditions. The studied ranges were modified following the trends of the Pareto charts of the screening. However the oxalic acid concentration is at the upper limit of the new range. Despite this, in order not to exceed the total dissolved solids coming into the ICP-MS, this concentration was taken as critical value for this variable (Table 7.5).

Table 7.3 ANOVA table of the optimization of ^{238}U .

Factor	p
(1) Oxalic acid concentration (L)	0.163906
Oxalic acid concentration (Q)	0.035557*
(2) HNO_3 concentration (L)	0.443508
HNO_3 concentration (Q)	0.380660
(3) Eluent volume (L)	0.009465*
Eluent volume (Q)	0.017014*
1L by 2L	0.164661
1L by 3L	0.121541
2L by 3L	0.075815
Factor	Value
Pure error (MS)	0.0000498
R-sqr	0.96525
Adj.	0.91053

The pure error is expressed as mean square (MS).

Table 7.4 ANOVA table of the optimization of ^{232}Th .

Factor	p
(1) Oxalic acid concentration (L)	0.011863*
Oxalic acid concentration (Q)	0.196287
(2) HNO_3 concentration (L)	0.055833
HNO_3 concentration (Q)	0.304148
(3) Eluent volume (L)	0.006614*
Eluent volume (Q)	0.101741
1L by 2L	0.566856
1L by 3L	0.064010
2L by 3L	0.671844
Factor	Value
Pure error (MS)	0.0001105
R-sqr	0.96269
Adj.	0.95757

The pure error is expressed as mean square (MS).

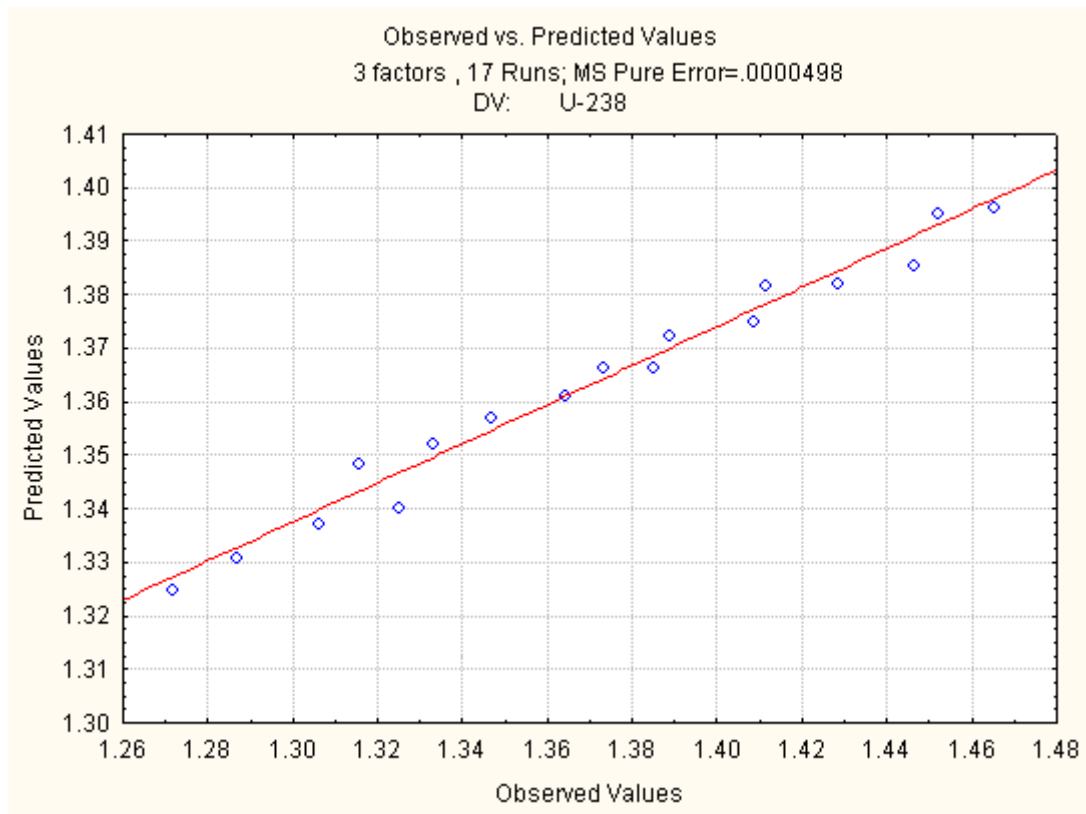

Figure 7.8 Predicted versus observed values of the optimization of ^{238}U .

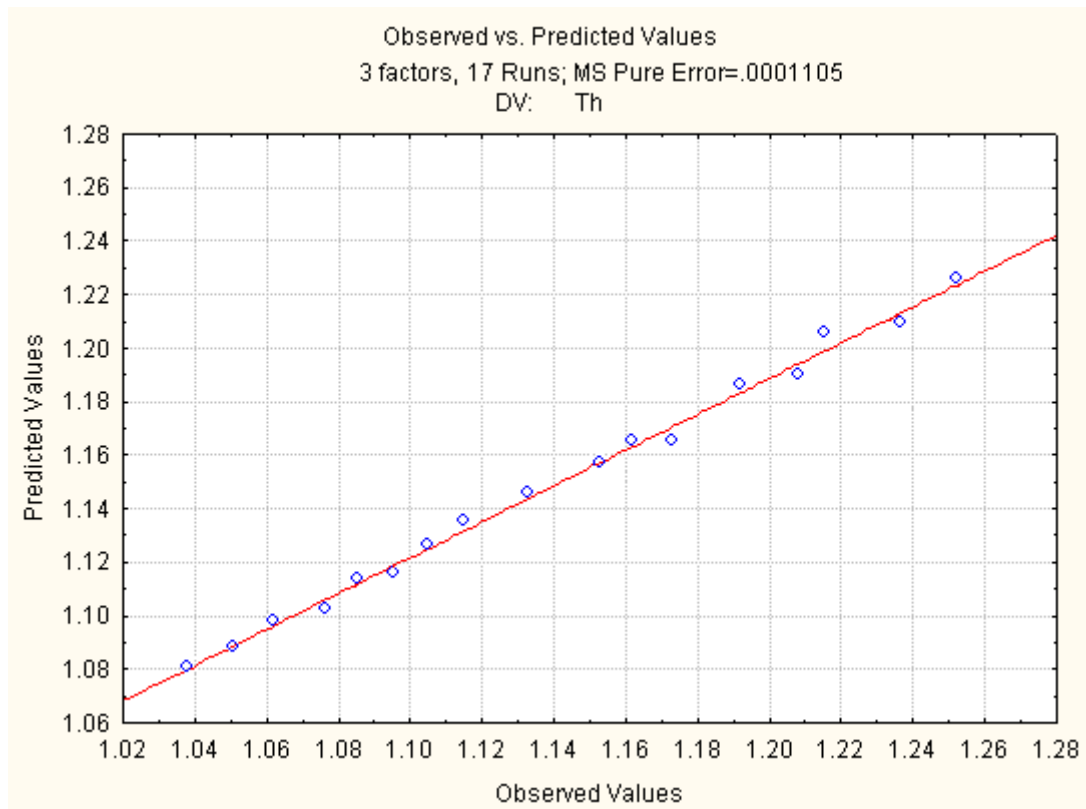

Figure 7.9 Predicted versus observed values of the optimization of ^{232}Th .

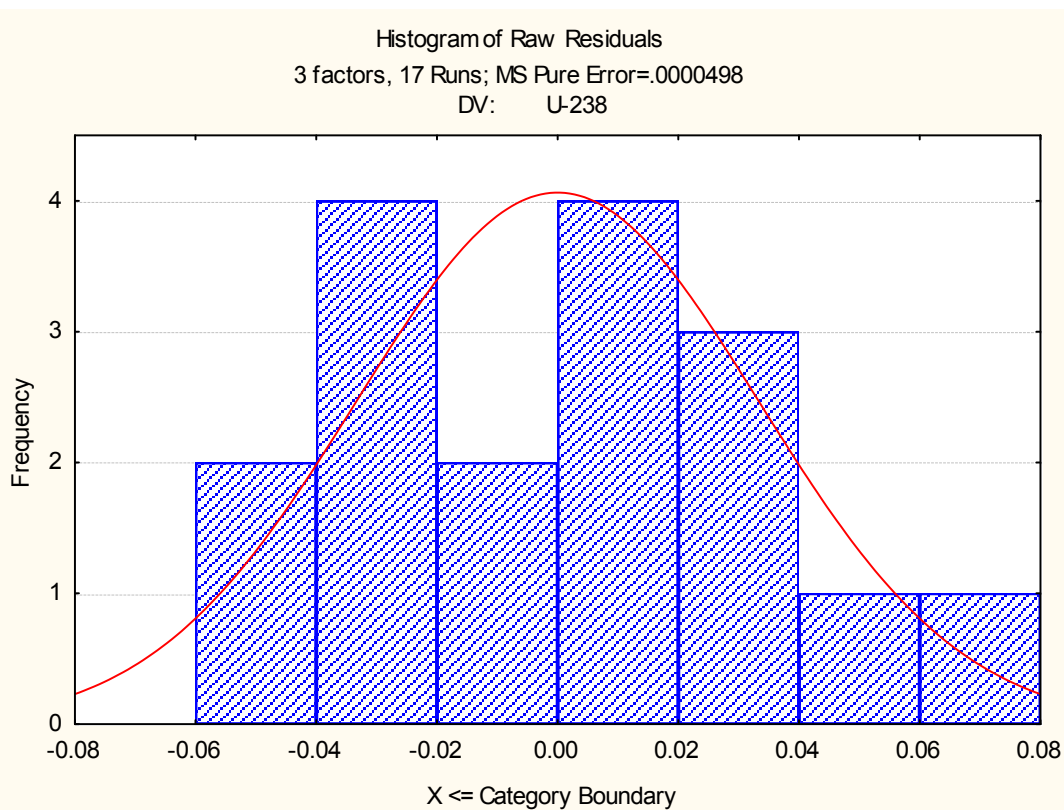

Figure 7.10 Histogram of raw residuals of the optimization of ^{238}U .

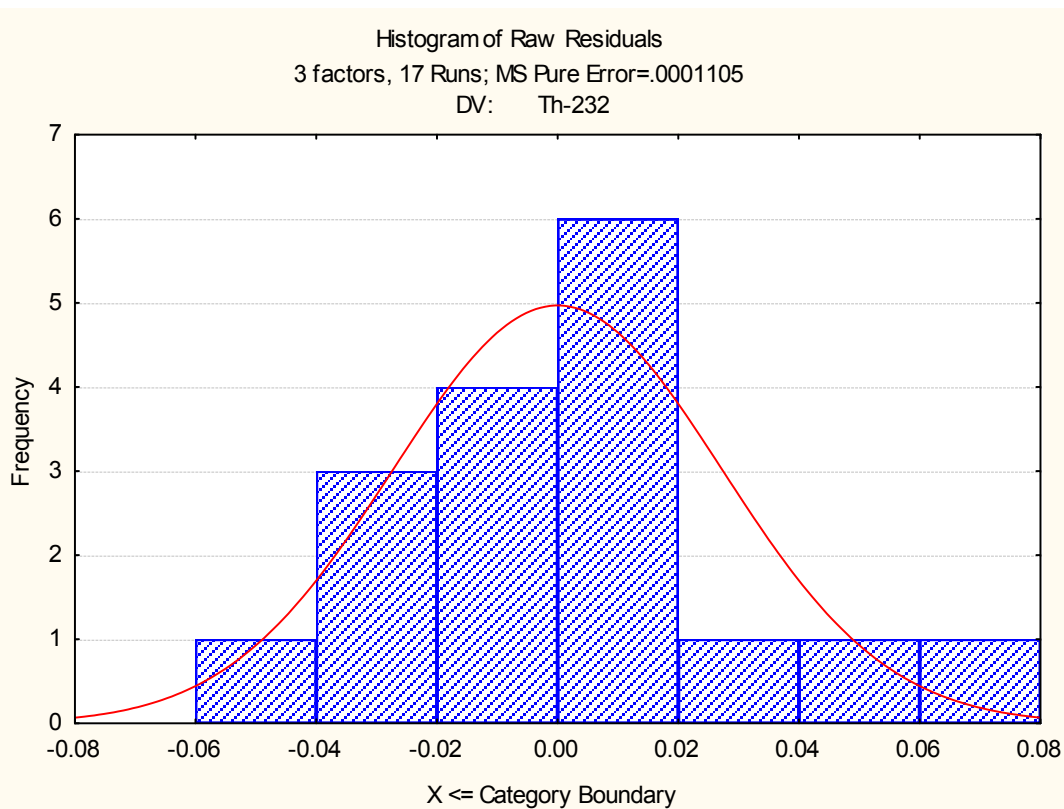

Figure 7.11 Histogram of raw residuals of the optimization of ^{232}Th .

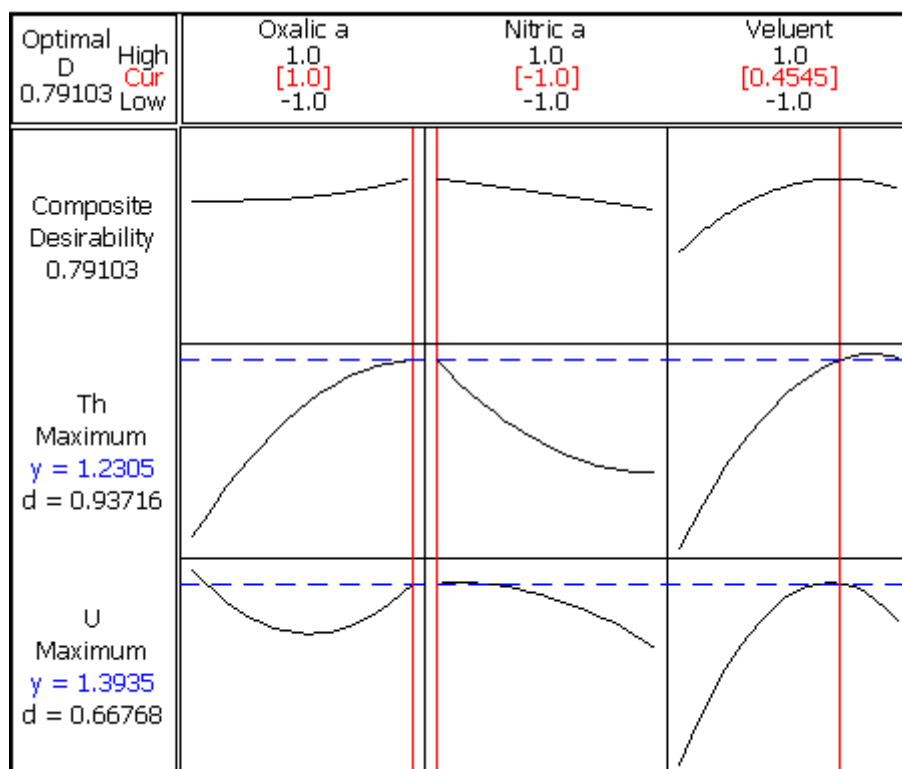

Figure 7.12 Desirability charts for the optimized variables.

Table 7.5 Decoded critical values.

Variable	Critical value
Nitric acid concentration	0.01 mol L ⁻¹
Oxalic acid concentration	0.05 mol L ⁻¹
Eluent volume	0.50 mL

Chapter 8

Conclusions

In the present doctoral thesis new automated approaches for total and isotopic analysis of thorium and uranium have been developed especially suited for analysis of environmental samples with very low levels of these elements. The multicommutated flow techniques used have shown great potential in automating systems allowing separation and preconcentration processes by solid phase extraction. These new methods have been focused in the development of alternatives to classical radiochemical determinations, which are laborious and time consuming.

The implementation of long path length capillary cells based on liquid core fiber optics to the spectrophotometric detection technique and its combination with multicommutated flow techniques improved the limits of detection of the developed systems providing portable low cost automated analyzers for thorium and uranium determination. Thus, these automated analyzers are excellent monitoring tools for thorium and uranium and are proposed as screening methodologies for these radionuclides following the new trends in legislation with regard to radioactive substances.

Spectrophotometric detection and ICP-MS have proved to be great alternatives, providing similar and even lower LODs than when using radiometric detectors, improving at the same time the sample analysis frequency and enabling the development of fully automated uranium and thorium analyzers.

Results have demonstrated that ICP-MS is an excellent tool for determining long lived radionuclides, such as thorium and uranium, offering low detection limits, and short analysis times. Moreover, ICP-MS is a technique ideally suited for the simultaneous determination of the concentration and isotopic composition of thorium and uranium.

The incorporation of feedback mechanisms in the control software allowed the development of a smart fully automated system for total uranium and thorium determination, being able to analyze the analytes of interest in a wide working range and with a high degree of automation. This is a step forward in automation which enables the system to work autonomously.

Reduction of the analysis time and therefore the increase of the injection throughput, together with the minimal handling of sample and reagents, improving the analyst safety, are characteristics achieved in all the developed systems which should also be highlighted. Moreover, the reproducibility and repeatability of the methodologies have also been upgraded, avoiding at the same time cross contamination since the proposed approaches are closed systems.

Reduction of the environmental impact per analysis has been accomplished by the hyphenation of different multicommutated flow techniques. This improved their individual advantages, complementing each other and attaining great advantages such as minimal reagents consumption and waste generation, which is of great importance when dealing with radioactive materials.

Summing up, several automated analyzers have been developed with a high degree of automation for fast total uranium and thorium determination at ultra-trace levels, and an automated method for isotopic analysis of both elements has also been presented in this thesis. Finally, it is worth to be mentioned that all the developed methods proposed in this thesis have been satisfactorily applied to environmental samples obtaining good recoveries for the different matrices analyzed. Moreover all the automated flow systems have been validated with reference materials.

Conclusiones

En esta tesis doctoral se han desarrollado nuevas metodologías para la determinación total y el análisis isotópico de muy bajas concentraciones de torio y uranio en muestras ambientales. Las técnicas de análisis en flujo multiconmutadas utilizadas en esta tesis han demostrado poseer un gran potencial para automatizar sistemas que incluyen procesos de separación y preconcentración mediante extracción en fase sólida. Estos nuevos métodos fueron diseñados con el objetivo de disponer de alternativas a las separaciones radioquímicas clásicas, que se caracterizan por ser laboriosas y de larga duración.

La implementación de celdas de largo paso óptico basadas en fibras ópticas con núcleo líquido a la espectrofotometría y su combinación con las técnicas de análisis en flujo mejoraron los límites de detección de los sistemas desarrollados, proporcionando al mismo tiempo equipos portátiles de bajo coste para la determinación de torio y uranio. Por lo que siguiendo las nuevas tendencias en legislación con respecto a sustancias radioactivas, se proponen como metodologías de cribado para los anteriormente citados radionúclidos.

La detección espectrofotométrica y la espectrometría de masas de plasma acoplado inductivamente (ICP-MS) han demostrado ser excelentes alternativas a la detección radiométrica, presentando límites de detección similares e incluso más bajos. Al mismo tiempo proporcionan una mayor frecuencia de análisis y permiten el desarrollo de sistemas totalmente automatizados para la determinación de torio y uranio.

Los resultados han demostrado que el ICP-MS es una herramienta extraordinaria para determinar radionúclidos de larga vida media, tales como torio y uranio, ofreciendo bajos límites de detección y tiempos de análisis. Además, ICP-MS es una técnica de gran utilidad para la determinación simultánea de la concentración de torio y uranio, así como de su composición isotópica.

La incorporación de mecanismos de retroalimentación en el software que controla los sistemas ha permitido el desarrollo de un sistema inteligente totalmente automatizado para determinar torio y uranio, siendo capaz de determinar estos analitos en un amplio rango de concentraciones y con un alto grado de automatización. Este avance permite trabajar de forma totalmente autónoma sin intervención del analista, mejorando la seguridad del mismo.

Cabe resaltar la reducción del tiempo de análisis, la cual conlleva el aumento de la frecuencia de inyección, junto con la mínima manipulación de reactivos y muestras por parte del analista, características comunes en todos los sistemas desarrollados. Otros aspectos a resaltar, y debido a que todos los sistemas desarrollados son cerrados, son la mejora significativa de la reproducibilidad y la repetitividad de las metodologías, evitando al mismo tiempo la contaminación cruzada.

Gracias al acoplamiento de varias técnicas de análisis en flujo multiconmutadas se ha conseguido reducir el impacto ambiental por análisis, complementándose unas con otras, logrando mejoras tales como la mínima generación de residuos y consumo de reactivos, aspecto de gran relevancia cuando se trabaja con materiales radioactivos.

Resumiendo, se han desarrollado varios sistemas automáticos para la determinación rápida de uranio y torio total a niveles de ultra-traza con un alto grado de automatización. También se presenta en esta tesis un método automático para el análisis isotópico de ambos elementos. Finalmente, cabe destacar que todos los métodos propuestos en esta tesis han sido aplicados con éxito a diferentes matrices ambientales, obteniendo buenas recuperaciones. Además todas las metodologías propuestas han sido validadas con materiales de referencia.

Annex

Publications included in this thesis

1. Automated determination of uranium(VI) at ultra trace levels exploiting flow techniques and spectrophotometric detection using a liquid waveguide capillary cell.
Authors: Jessica Avivar, Laura Ferrer, Montserrat Casas and Víctor Cerdà.
Journal: Analytical and Bioanalytical Chemistry
Year: 2010 **Number:** 397 **Pages:** 871-878.
2. Automation of radiochemical analysis by applying flow techniques to environmental samples.
Authors: Yamila Fajardo, Jessica Avivar, Laura Ferrer, Enrique Gómez, Montserrat Casas and Víctor Cerdà.
Journal: Trends in Analytical Chemistry
Year: 2010 **Number:** 11 **Pages:** 1399-1408.
3. Lab on valve-Multisyringe flow injection system (LOV-MSFIA) for fully automated uranium determination in environmental samples.
Authors: Jessica Avivar, Laura Ferrer, Montserrat Casas and Víctor Cerdà.
Journal: Talanta
Year: 2011 **Number:** 84 **Pages:** 1221-1227.
4. Smart thorium and uranium determination exploiting renewable solid phase extraction applied to environmental samples in a wide concentration range.
Authors: Jessica Avivar, Laura Ferrer, Montserrat Casas and Víctor Cerdà.
Journal: Analytical and Bioanalytical Chemistry
Year: 2011 **Number:** 400 **Pages:** 3585-3594.
5. Fully automated lab-on-valve-multisyringe flow injection analysis-ICP-MS system: an effective tool for fast, sensitive and selective determination of thorium and uranium at environmental levels exploiting solid phase extraction
Authors: Jessica Avivar, Laura Ferrer, Montserrat Casas and Víctor Cerdà.
Journal: Journal of Analytical Atomic Spectrometry
Year: 2012 **Number:** 27 **Pages:** 327-334.

6. Laboratory Automation

Authors: Jessica Avivar, Amalia Cerdà and Víctor Cerdà.

Journal: Pure and Applied Chemistry

Year: 2012 **Status:** submitted for publication

Other publications

These publications are enclosed at the end of this section.

1. Técnicas de análisis en flujo aplicadas a la determinación totalmente automatizada de trazas de uranio.

Authors: Jessica Avivar, Laura Ferrer, Montserrat Casas and Víctor Cerdà.

Book: VI Jornadas sobre calidad en el control de la radioactividad ambiental. Ed. Consejo de Seguridad Nuclear

Year: 2011 **Legal Diposit:** BI 2536/2011 **Pages:** 236-245.

2. Automated total and radioactive strontium separation and preconcentration in samples of environmental interest exploiting a lab-on-valve system.

Authors: Rogelio Rodríguez, Jessica Avivar, Laura Ferrer, Luz O. Leal and Víctor Cerdà.

Journal: Talanta

Year: 2011 **DOI:** 10.1016/j.talanta.2011.11.042

Congress communications

1. Development of a MSFIA-MPFS method for uranium separation and preconcentration followed by spectrophotometric detection using a long path length liquid waveguide capillary cell.

Authors: Jessica Avivar, Laura Ferrer, Montserrat Casas and Víctor Cerdà.

Congress: XI Flow Analysis.

Year: 2009 **Place:** Pollença-Spain **Type of communication:** Póster

2. Development of a MSFIA-MPFS method for uranium separation and preconcentration followed by spectrophotometric detection using a long path length liquid waveguide capillary cell.

Authors: Jessica Avivar, Laura Ferrer, Montserrat Casas and Víctor Cerdà.

Congress: XI Flow Analysis.

Year: 2009 **Place:** Pollença-Spain **Type of communication:** Workshop

3. Ultra trace uranium automated determination exploiting flow techniques and spectrophotometric detection.

Authors: Jessica Avivar, Laura Ferrer, Montserrat Casas and Víctor Cerdà.

Congress: XI Flow Analysis.

Year: 2009 **Place:** Pollença-Spain **Type of communication:** Lecture

4. Radioisotopes determination by flow techniques.

Authors: Jessica Avivar.

Congress: Les doctoriales transfrontalières.

Year: 2009 **Place:** Pollença-Spain **Type of communication:** Poster

5. Multisyringe flow injection–Lab on valve system (MSFIA-LOV) for fully automated uranium determination at ultra trace levels.

Authors: Jessica Avivar, Laura Ferrer, Montserrat Casas and Víctor Cerdà.

Congress: 16th International Conference in Flow Injection Analysis (ICFIA).

Year: 2010 **Place:** Pattaya-Thailand **Type of communication:** Lecture

6. MSFIA-LOV: a fully automated miniaturized system for radioisotopes isolation and determination at ultra trace levels.

Authors: Jessica Avivar, Laura Ferrer, Montserrat Casas and Víctor Cerdà.

Congress: II International Workshop on Analytical Miniaturization (“lab-on-a-chip”) (IWAM).

Year: 2010 **Place:** Oviedo-Spain **Type of communication:** Poster

7. Monitoring of uranium in environmental samples by means of flow techniques.

Authors: Jessica Avivar, Laura Ferrer, Montserrat Casas and Víctor Cerdà.

Congress: The 55th Annual Meeting of the Health Physics Society.

Year: 2010 **Place:** Utah-USA **Type of communication:** Poster

8. Técnicas de análisis en flujo aplicadas a la determinación totalmente automatizada de trazas de uranio.

Authors: Jessica Avivar.

Congress: VI Jornadas sobre calidad en el control de la radioactividad ambiental.

Year: 2010 **Place:** Cáceres-Spain **Type of communication:** Lecture

9. Fully automated LOV-MSFIA-ICP-MS system for thorium and uranium determination exploiting renewable solid phase extraction applied to environmental samples.

Authors: Jessica Avivar, Laura Ferrer, Montserrat Casas and Víctor Cerdà.

Congress: 17th International Conference in Flow Injection Analysis (ICFIA).

Year: 2011 **Place:** Krakow-Poland **Type of communication:** Lecture

10. LOV system for fully automated of stable and radioactive strontium determination in samples of environmental interest.

Authors: Rogelio Rodríguez, Jessica Avivar, Laura Ferrer, Luz O Leal and Víctor Cerdà.

Congress: 17th International Conference in Flow Injection Analysis (ICFIA).

Year: 2011 **Place:** Krakow-Poland **Type of communication:** Poster

11. SIA and MSFIA determination of radiochemical isotopes in environmental samples.

Authors: Víctor Cerdà, Laura Ferrer, Jessica Avivar and Montserrat Casas.

Congress: 17th International Conference in Flow Injection Analysis (ICFIA).

Year: 2011 **Place:** Krakow-Poland **Type of communication:** Keynote Lecture

- 12.** Thorium determination at ultra-trace levels exploiting LOV-MSFIA techniques.
Authors: Jessica Avivar, Laura Ferrer, Montserrat Casas and Víctor Cerdà.
Congress: IUPAC International Congress on Analytical Sciences.
Year: 2011 **Place:** Kyoto-Japan **Type of communication:** Poster
- 13.** Radiochemical multicommutated flow techniques applied to environmental samples.
Authors: Víctor Cerdà, Laura Ferrer, Jessica Avivar and Montserrat Casas.
Congress: IUPAC International Congress on Analytical Sciences.
Year: 2011 **Place:** Kyoto-Japan **Type of communication:** Keynote Lecture
- 14.** Smart thorium and uranium determination exploiting renewable solid phase extraction applied to environmental samples in a wide concentration range.
Authors: Jessica Avivar, Laura Ferrer, Montserrat Casas and Víctor Cerdà.
Congress: Argentina y Ambiente. Congreso Internacional de Ciencia y Tecnología Ambiental.
Year: 2012 **Place:** Mar del Plata-Argentina **Type of communication:** Poster