



UNIVERSITAT DE
BARCELONA

Anàlisi dels processos educatius en base a la metodologia observacional: la interacció entre iguals

Maria Rosa Buxarrais Estrada



Aquesta tesi doctoral està subjecta a la llicència **Reconeixement- NoComercial – SenseObraDerivada 4.0. Espanya de Creative Commons.**

Esta tesis doctoral está sujeta a la licencia **Reconocimiento - NoComercial – SinObraDerivada 4.0. España de Creative Commons.**

This doctoral thesis is licensed under the **Creative Commons Attribution-NonCommercial-NoDerivs 4.0. Spain License.**

UNIVERSITAT DE BARCELONA

DIVISIÓ DE CIÈNCIES DE L'EDUCACIÓ

FACULTAT DE PEDAGOGIA

DEPARTAMENT DE TEORIA I HISTÒRIA DE L'EDUCACIÓ

ANÀLISI DELS PROCESSOS EDUCATIUS EN
BASE A LA METODOLOGIA OBSERVACIONAL:
LA INTERACCIÓ ENTRE IGUALS

TD
415

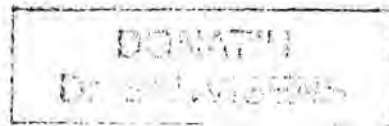

Tesi doctoral presentada per **M^a Rosa Buxarrais Estrada**

Dirigida pel Dr. Miquel Martínez Martín

Catedràtic de Teoria de l'Educació de la Universitat de Barcelona

Barcelona, desembre de 1990.

BIBLIOTECA DE LA UNIVERSITAT DE BARCELONA



0700692952

6.2.7.- Fiabilitat: Acord entre observadors.

Quan un investigador en el camp educatiu fa servir l'observació per tal d'obtenir coneixement científic, l'interessa primordialment aconseguir la màxima precisió possible, la qual cosa implica, com ja hem vist, un correcte plantejament del problema, un bon sistema de categories, observadors ensinistrats i unes mostres adients.

Però la qüestió que pot preocupar més són les dades recollides. Aquestes han d'ésser independents de l'observador. Pot ser que la persona que planifica l'estudi no sigui la mateixa que la que porta a terme el registre, això podria comportar problemes en la forma d'interpretar el que es percep, matisos diferents respecte al significat de les categories, propensió a les errades d'omissió o comissió.

Per solucionar aquest problema, s'ha obtat per aconseguir un equip d'observadors que enregistrin simultàniament la mateixa situació, a partir del sistema de categories establert, amb el mateix punt físic de mira, i les mateixes tècniques de registre i mostreig. S'ha de generar un consens entre els observadors, i la millor forma de fer-ho no és enregistrant simultàniament a la classe o al pati, sinó a partir de material videogràfic, sessions gravades, de les situacions educatives.

6.2.7.1.- Fiabilitat consensuada.

Quan s'ha tractat d'abordar aquesta temàtica han aparegut problemes terminològics, a vegades s'han utilitzat diferents termes amb matisos i significats diferents, com a punt de referència de diversos treballs realitzats en profunditat. Es parla de termes com acord, fiabilitat i concordança (Bakeman i Gottman, 1986; Hartmann i Wood, 1982, Berk, 1979; Martin i Bateson, 1986; Cone, 1982, Kerlinger, 1973; Suen i Lee, 1985; Balnco, 1986).

Segons Bakeman i Gottman (1987) com a mínim hi ha tres raons per les quals interessa determinar la concordança entre els observadors: 1) com a investigadors, necessitem assegurar que els observadors estiguin codificant conductes i esdeveniments d'acord amb les definicions prèvies; 2) és útil per proporcionar un "feed-back" als observadors; i 3) la necessitat de garantir que els observadors són indispensables i els procediments replicables. Anguera (1989) no està d'acord amb aquesta tercera raó, raonant la no equivalència entre precisió i concordança.

Si definim "concordança" com la mesura en que dos o més observadors estan d'acord entre si (concordança interobservadors) o un observador amb si mateix en diferents moments (concordança intraobservador) sempre que s'enregistren els mateixos comportaments mitjançant el mateix sistema de codis, hem optat per la primera, però amb matisos. Es tracta de la concordança consensuada. Aquest tipus de concordança va adquirint protagonisme en l'àmbit de la metodologia observacional per les seves facilitats, ja que ens permet obtenir un enregistrament únic i l'important enfortiment del sistema de categories (Anguera, 1989).

En el nostre cas, hem portat a terme el procés de categorització, dos observadors, amb això pretenem garantir la captació del mateix significat i els matisos de cada categoria, facilitant el registre conjunt consensuat, i assignant a cada unitat de conducta la corresponent categoria. Aquesta manera de portar a terme el procés, ha fet innecessari el càlcul de la fiabilitat interobservadors (Blanco, 1983; Blanco i Anguera, 1984).

6.2.8.- Anàlisi de les dades observacionals.

6.2.8.1.- Fases de l'anàlisi.

L'estratègia general d'anàlisi ha constatat de dues fases. La primera és "global" o macro-analítica i en ella es descriuen quantitativament els subsistemes conductuals sense fer èmfasi en les seves 'trajectòries' temporals; els indicadors obtinguts en aquesta fase resumeixen aquestes trajectòries. La segona fase es considera pròpiament micro-analítica i en ella es plantegen qüestions específiques sobre contingències seqüencials. No s'analitzen totes les contingències seqüencials possibles sinó, i com aconsella Suomi (1979), aquelles que en la fase macro-analítica han estat rellevants.

La primera fase va consistir en l'obtenció de mesures descriptives globals per a cadascuna de les categories conductuals i per a cadascun dels subsistemes. En base als resultats es va procedir a la re-categorització dels subsistemes, procés que va reduir el nombre de categories.

La fase micro-analítica va consistir en l'aplicació del mètode d'anàlisi seqüencial de retard en classe interactiva a alguns parells de conductes seleccionades.

L'anàlisi s'ha portat a terme mitjançant el computador IBM 3083XE del Centre d'Informàtica de la Universitat de Barcelona. S'ha fet servir el programa ASR (Analitzador Sequencial de Retard) - es troba en l'annex 6- creat per Vicenç Quera del Departament de Metodologia de les Ciències de Comportament de la Facultat de Psicologia de la Universitat de Barcelona. Aquest programa ens ha servit per obtenir resultats globals, com freqüències i probabilitats, discretes i contínues, globals de totes les conductes i estadístics derivats.

6.2.8.2.- Mesures globals.

Vàrem obtenir mesures i estadístics descriptius de totes les conductes categoritzades. Amb això pretenem conèixer el comportament dels subsistemes a

nivell global i poder agrupar o suprimir categories, és a dir, recategoritzar, si les freqüències d'ocurrència de les categories eren baixes. D'aquesta descripció macroanalítica no ens és possible extreure conclusions sobre la dinàmica de la interacció ni, tampoc, suposa la micro-anàlisi que s'ha esmentat.

Les mesures emprades són referides a les categories: freqüència, ordre i durada.

La freqüència es refereix al nombre d'ocurrències d'una categoria conductual. La durada serà el nombre de segons que ha tingut lloc una determinada categoria conductual durant totes les sessions. L'ordre es tindrà en compte en la fase de l'anàlisi seqüencial, i ens permetrà veure quin tipus de seqüències conductuals apareixen en les diverses situacions plantejades.

En les taules següents s'exposen els resultats globals de cada categoria conductual atenent al tipus d'organització social de l'activitat. A més, s'han representat gràficament les que tenien una freqüència significativa en el conjunt de dades.

UV		US		CF		VC		LC	
UV01	9	US01	3	CF01	0	VC01	0	LC01	11
UV02	214	US02	196	CF02	0	VC02	0	LC02	3
UV03	113	US03	1	CF03	7	VC03	0	LC03	2
UV04	7	US04	1	CF04	3	VC04	0	LC04	0
UV05	1	US05	20	CF05	0	VC05	11	LC05	0
UV06	26	US06	15	CF06	0	VC06	3	LC06	0
UV07	5	US07	26	CF07	521	VC07	85	LC07	0
UV08	2	US08	5			VC08	8	LC08	0
UV09	4	US09	57			VC09	14	LC09	0
UV10	41	US10	2			VC10	1	LC10	13
UV11	8	US11	0			VC11	0	LC11	0
UV12	22	US12	8			VC12	409	LC12	0
UV13	24	US13	123					LC13	0
UV14	5	US14	3					LC14	0
UV15	42	US15	71					LC15	0
UV16	4							LC16	0
UV17	0							LC17	0
								LC18	502
	531		460		10		122		29

UV		US		CF		VC		LC	
UV01	30	US01	3	CF01	0	VC01	0	LC01	21
UV02	562	US02	418	CF02	0	VC02	0	LC02	3
UV03	209	US03	1	CF03	15	VC03	0	LC03	5
UV04	30	US04	1	CF04	4	VC04	0	LC04	0
UV05	11	US05	36	CF05	0	VC05	43	LC05	0
UV06	26	US06	18	CF06	0	VC06	6	LC06	0
UV07	6	US07	35	CF07	-	VC07	149	LC07	0
UV08	2	US08	13			VC08	18	LC08	0
UV09	6	US09	155			VC09	26	LC09	0
UV10	83	US10	4			VC10	2	LC10	23
UV11	15	US11	0			VC11	0	LC11	0
UV12	47	US12	14			VC12	-	LC12	0
UV13	81	US13	452					LC13	0
UV14	8	US14	6					LC14	0
UV15	185	US15	-					LC15	0
UV16	8							LC16	0
UV17	0							LC17	0
								LC18	-
TOTAL	1303		1156		19		244		52

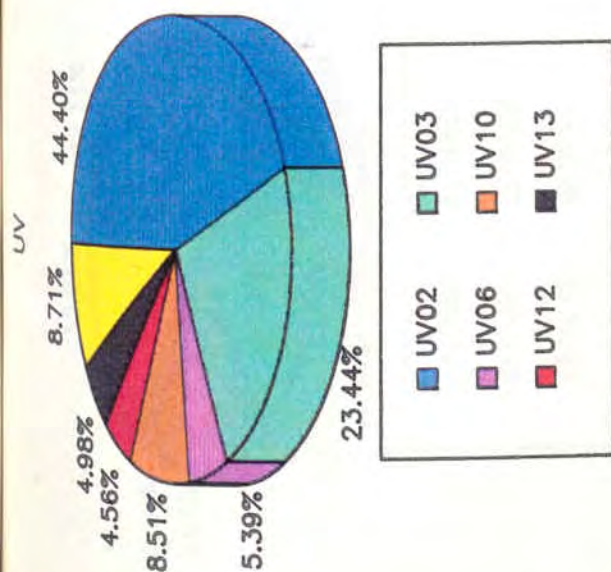
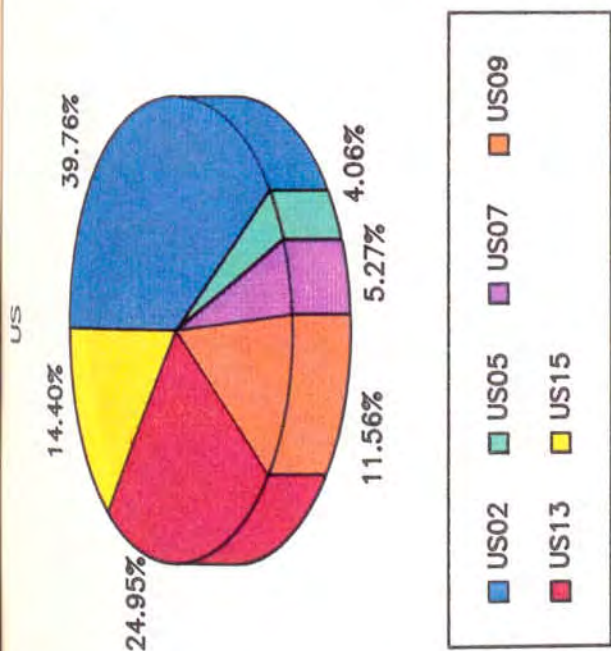
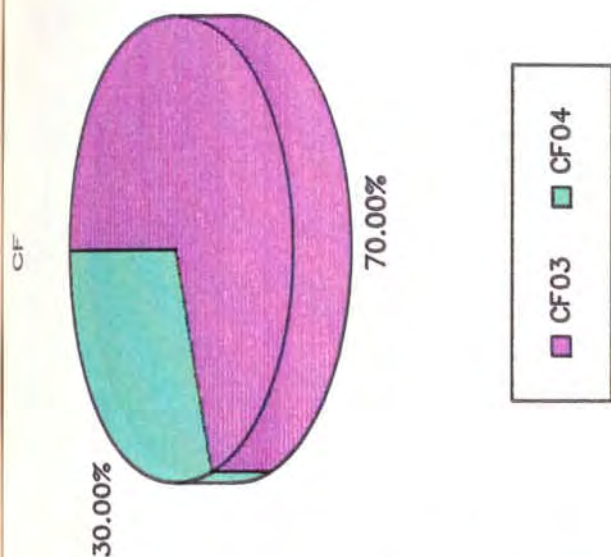

SITUACIONS INDIVIDUALS
FREQUÈNCIA

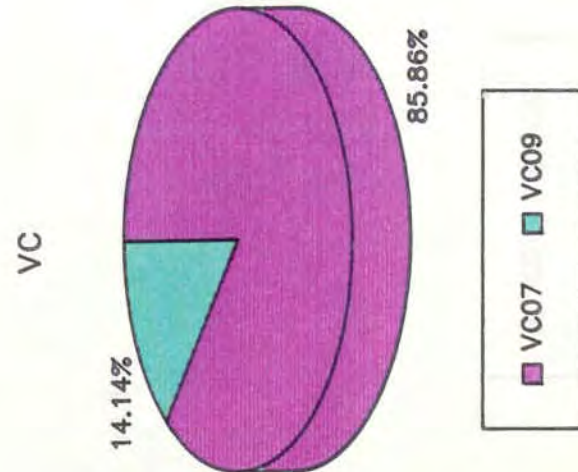
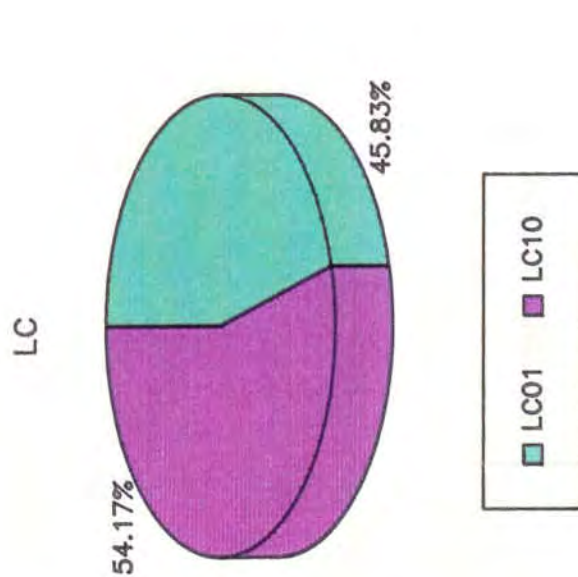

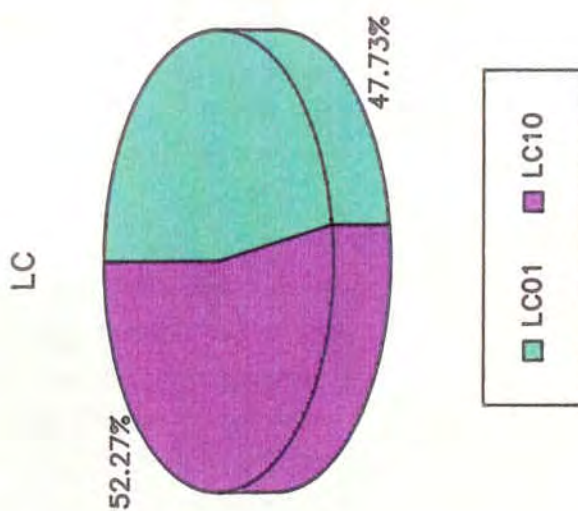
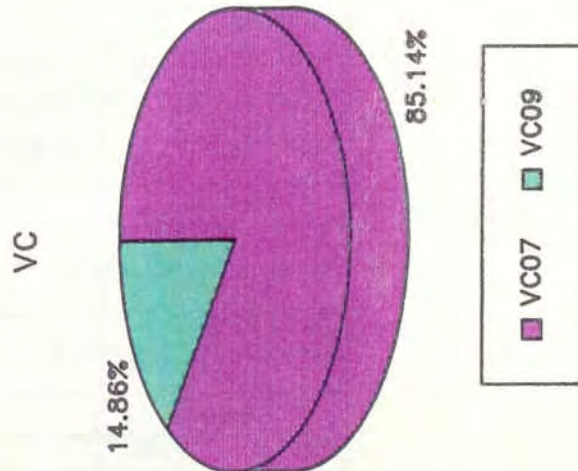
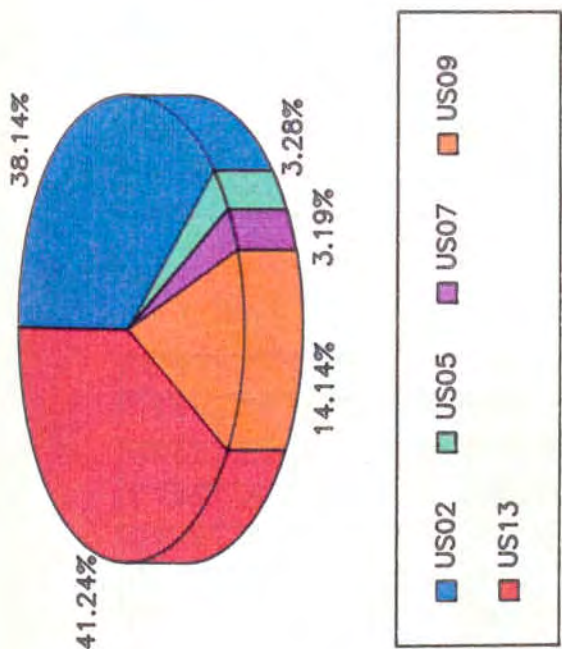
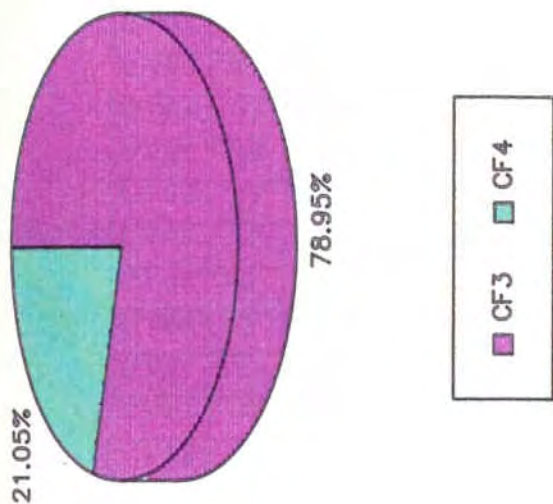
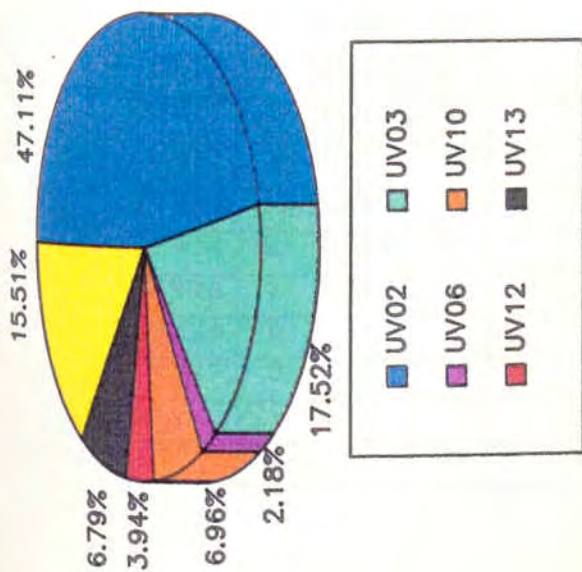

SITUACIONES INDIVIDUALS
DURADA, EN SEGONS

UV		US		CF		VC		LC	
UV01	13	US01	5	CF01	0	VC01	0	LC01	24
UV02	108	US02	138	CF02	0	VC02	0	LC02	2
UV03	189	US03	2	CF03	10	VC03	0	LC03	0
UV04	73	US04	4	CF04	32	VC04	0	LC04	0
UV05	19	US05	2	CF05	0	VC05	10	LC05	0
UV06	47	US06	3	CF06	19	VC06	11	LC06	0
UV07	22	US07	9	CF07	586	VC07	47	LC07	0
UV08	0	US08	18			VC08	51	LC08	5
UV09	2	US09	13			VC09	5	LC09	5
UV10	52	US10	3			VC10	1	LC10	53
UV11	42	US11	0			VC11	0	LC11	0
UV12	11	US12	2			VC12	522	LC12	0
UV13	10	US13	8					LC13	0
UV14	51	US14	0					LC14	0
UV15	8	US15	440					LC15	0
UV16	0							LC16	6
UV17	0							LC17	15
								LC18	537
	647		207		61		125		110

UV		US		CF		VC		LC	
UV01	30	US01	7	CF01	0	VC01	0	LC01	28
UV02	212	US02	227	CF02	0	VC02	0	LC02	2
UV03	464	US03	2	CF03	21	VC03	0	LC03	0
UV04	188	US04	5	CF04	59	VC04	0	LC04	0
UV05	44	US05	2	CF05	0	VC05	11	LC05	0
UV06	52	US06	3	CF06	25	VC06	13	LC06	0
UV07	25	US07	10	CF07	-	VC07	68	LC07	0
UV08	0	US08	21			VC08	67	LC08	5
UV09	2	US09	43			VC09	9	LC09	6
UV10	91	US10	8			VC10	8	LC10	117
UV11	79	US11	0			VC11	0	LC11	0
UV12	20	US12	2			VC12	-	LC12	0
UV13	31	US13	15					LC13	0
UV14	85	US14	0					LC14	0
UV15	8	US15	-					LC15	0
UV16	0							LC16	11
UV17	0							LC17	16
								LC18	-
	1320		345		105		176		185

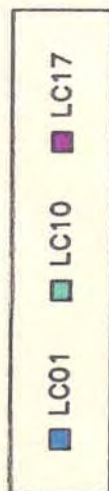
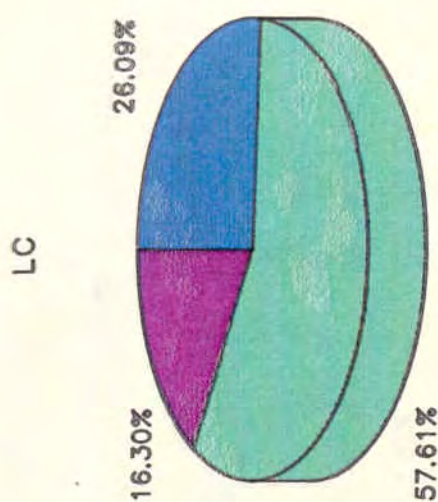
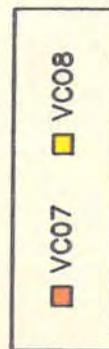
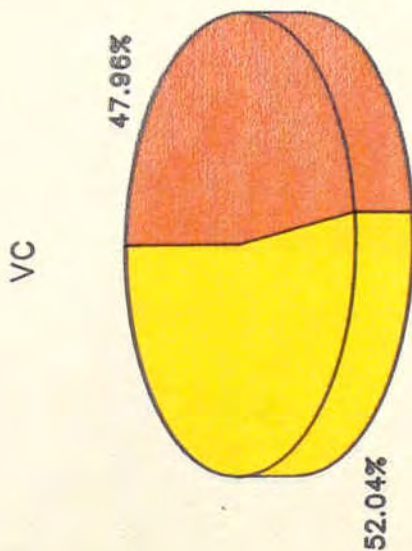
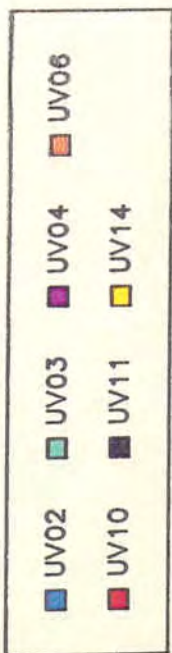
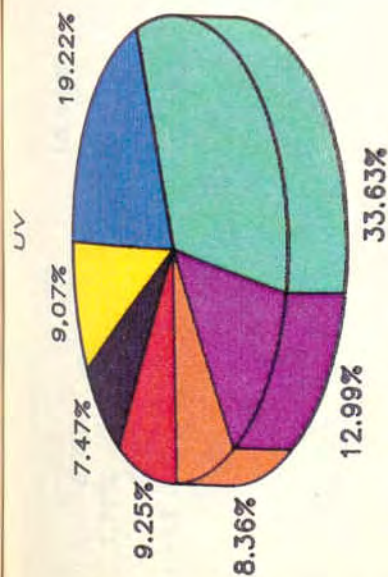
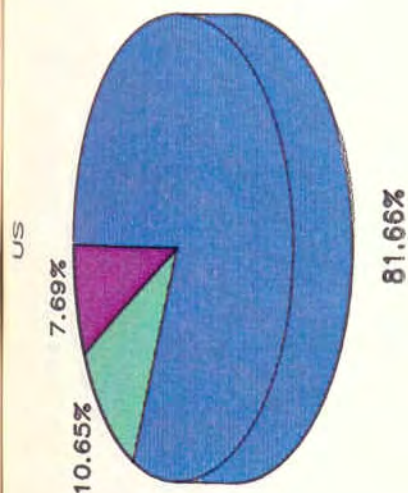
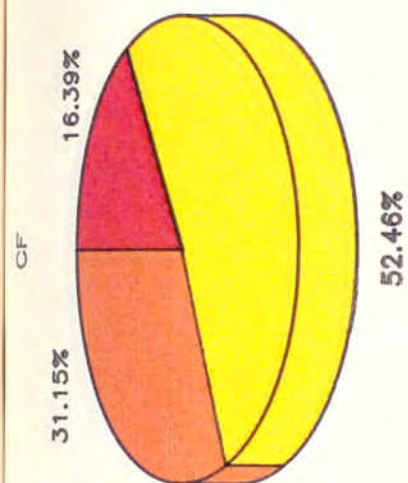

SITUACIONS COL·LECTIVES
FREQUÈNCIA

UV

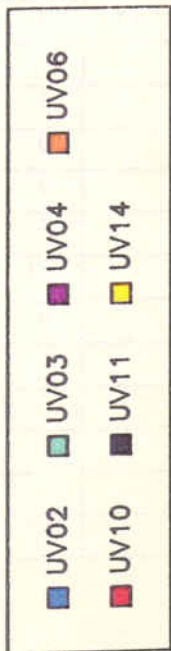
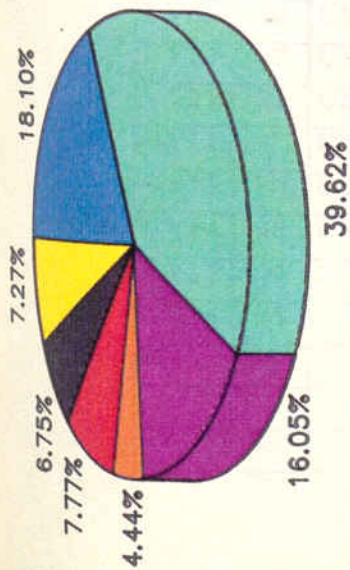

US

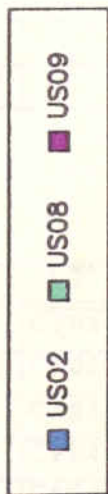
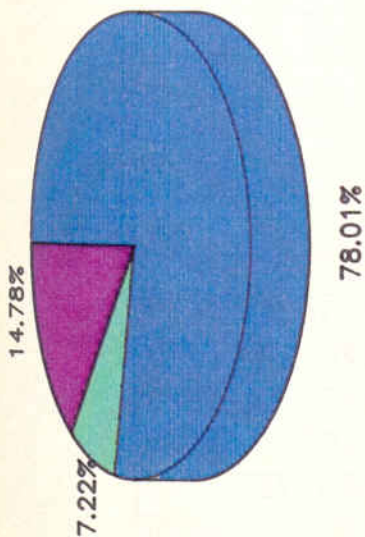

CF

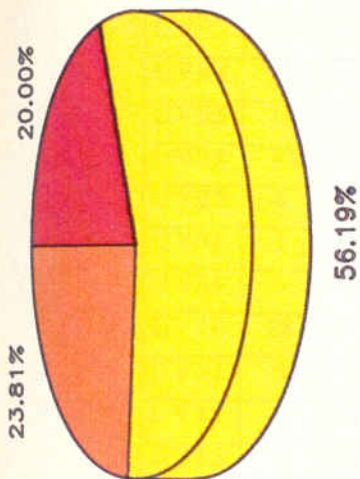

VC

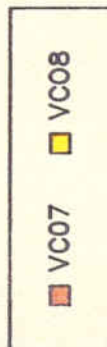
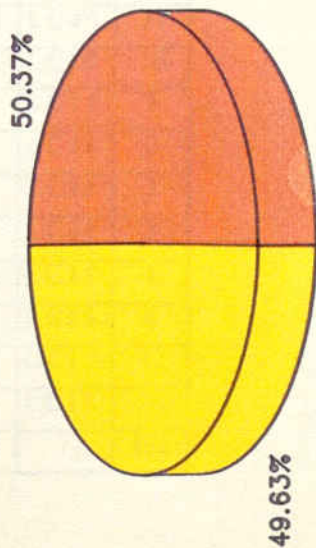

LC

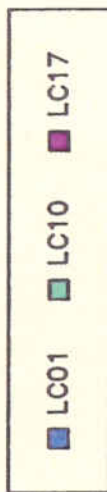
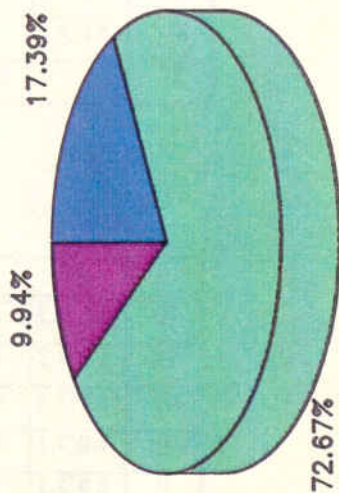

SITUACIONS COLLECTIVES
DURADA, EN SEGONS

UV		US		CF		VC		LC	
UV01	9	US01	8	CF01	68	VC01	1	LC01	21
UV02	129	US02	91	CF02	0	VC02	0	LC02	7
UV03	81	US03	4	CF03	15	VC03	0	LC03	2
UV04	20	US04	1	CF04	30	VC04	0	LC04	0
UV05	16	US05	5	CF05	0	VC05	2	LC05	0
UV06	30	US06	7	CF06	1	VC06	2	LC06	0
UV07	4	US07	5	CF07	312	VC07	101	LC07	1
UV08	1	US08	11			VC08	7	LC08	0
UV09	5	US09	2			VC09	79	LC09	15
UV10	28	US10	0			VC10	20	LC10	7
UV11	6	US11	0			VC11	0	LC11	3
UV12	0	US12	1			VC12	214	LC12	0
UV13	37	US13	61					LC13	3
UV14	10	US14	0					LC14	1
UV15	37	US15	235					LC15	1
UV16	4							LC16	6
UV17	4							LC17	11
								LC18	348
	426		191		114		212		78

UV		US		CF		VC		LC	
UV01	27	US01	11	CF01	112	VC01	2	LC01	69
UV02	349	US02	155	CF02	0	VC02	0	LC02	11
UV03	153	US03	6	CF03	22	VC03	0	LC03	10
UV04	26	US04	1	CF04	54	VC04	0	LC04	0
UV05	35	US05	6	CF05	0	VC05	2	LC05	0
UV06	32	US06	7	CF06	2	VC06	2	LC06	0
UV07	4	US07	11	CF07		VC07	185	LC07	1
UV08	1	US08	17			VC08	11	LC08	0
UV09	10	US09	8			VC09	176	LC09	37
UV10	47	US10	0			VC10	59	LC10	10
UV11	23	US11	0			VC11	0	LC11	3
UV12	0	US12	1			VC12		LC12	0
UV13	141	US13	169					LC13	3
UV14	16	US14	0					LC14	2
UV15	79	US15						LC15	1
UV16	15							LC16	6
UV17	5							LC17	12
								LC18	
	963		385		190		437		165

CF

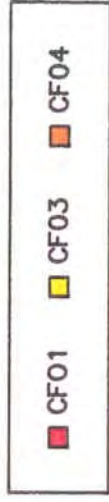
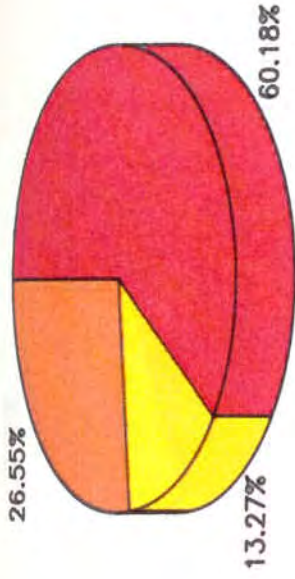

US

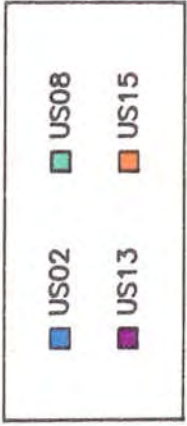
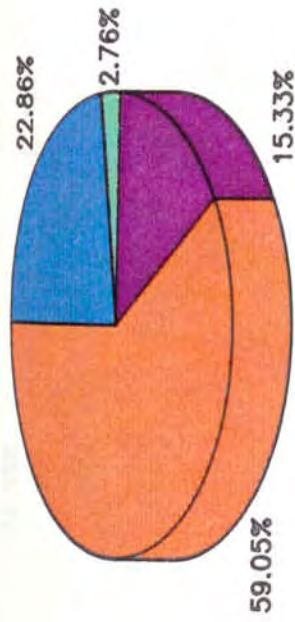

UV

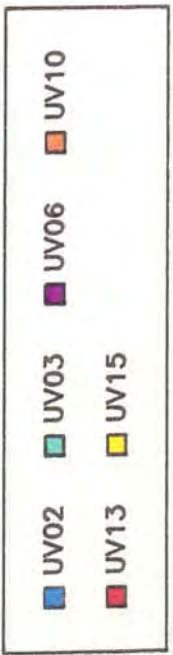
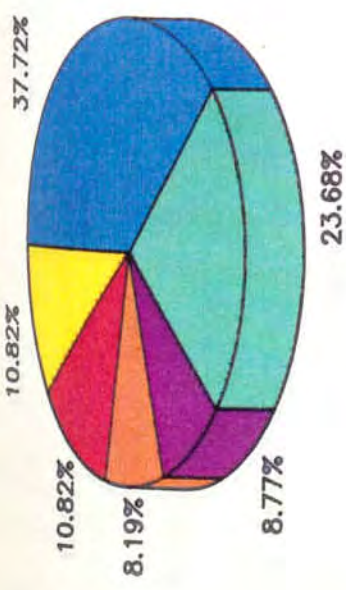

LC

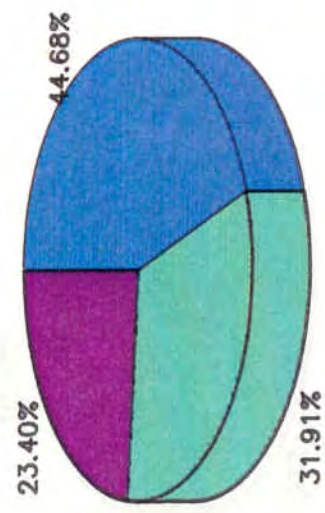

VC

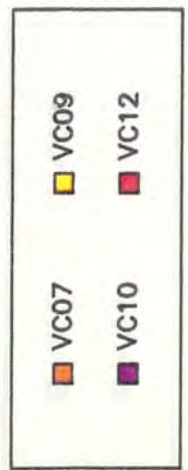
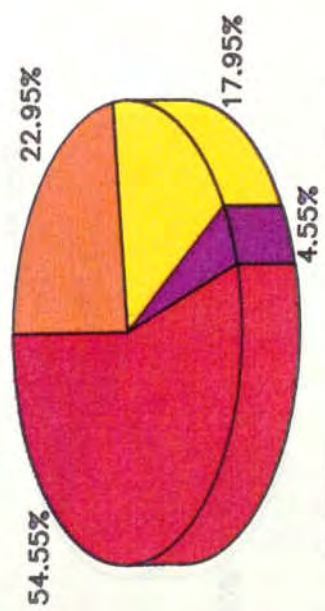

SITUACIONS COOPERATIVES
FREQUÈNCIA

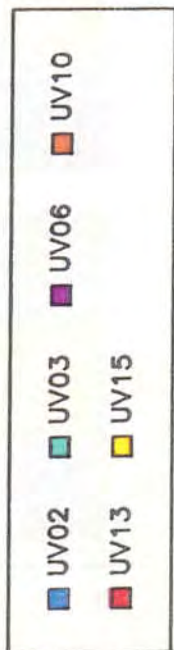
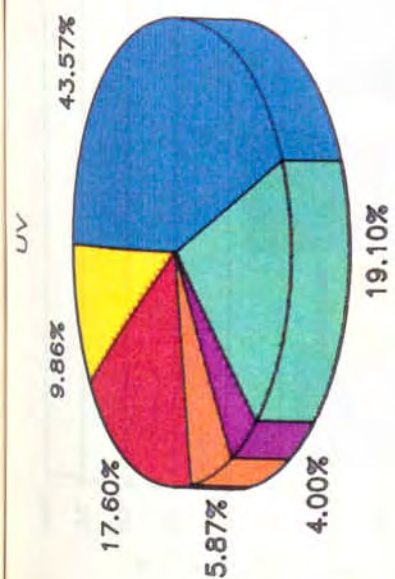
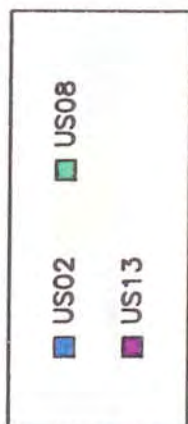
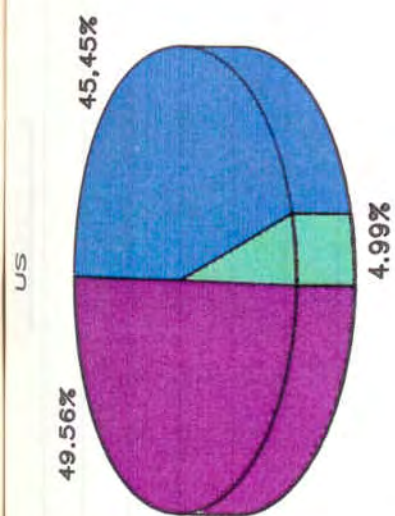
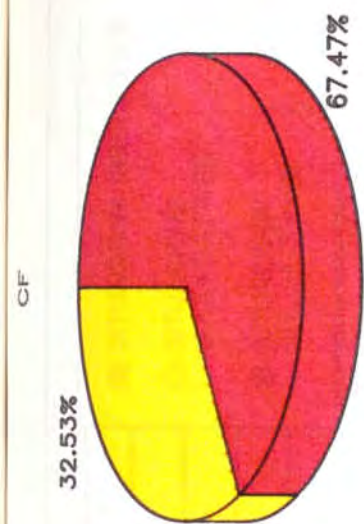

SITUACIONS COOPERATIVES
DURADA, EN SEGONS

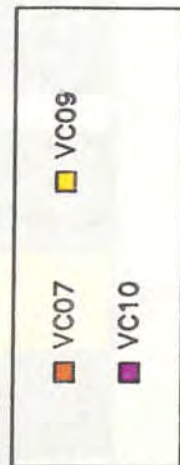
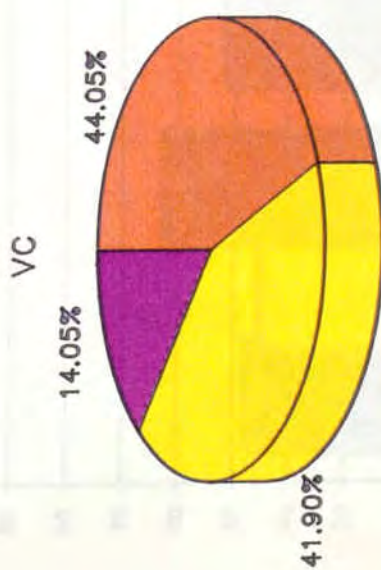
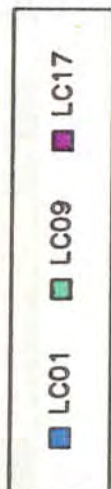
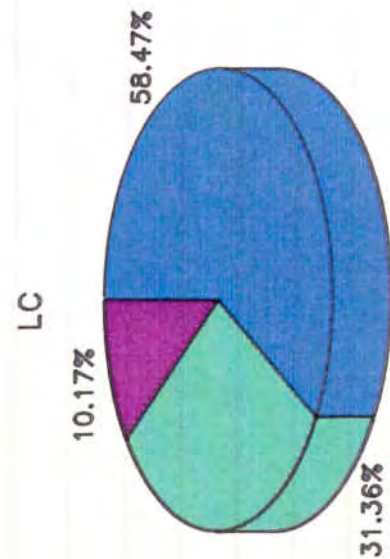

FREQUENCIES

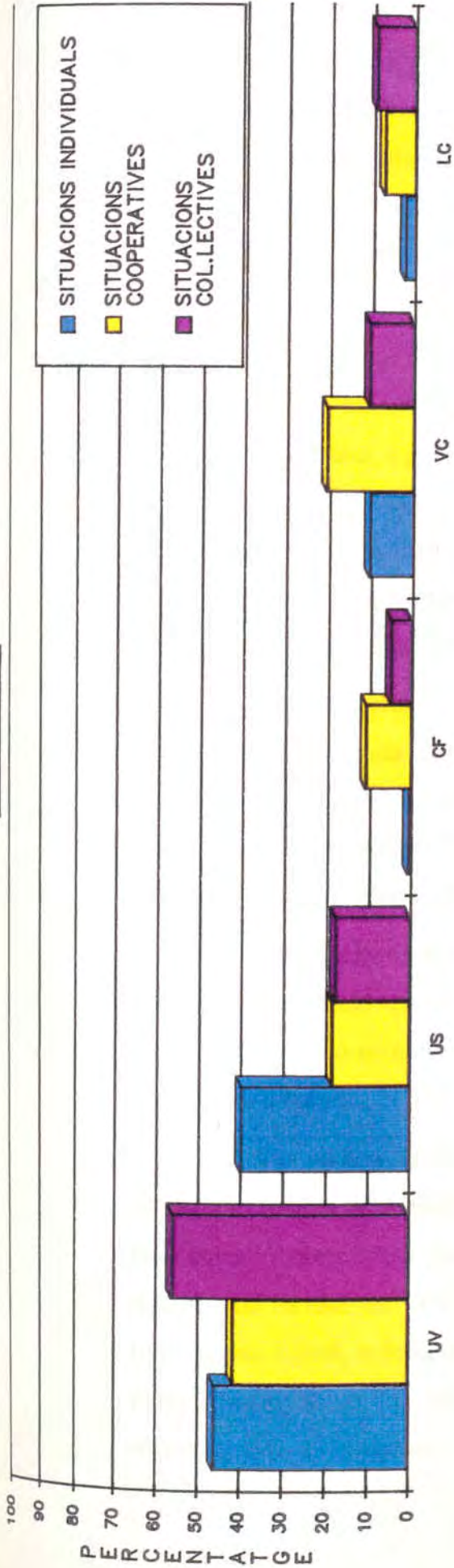

DURADA, EN SEGONS

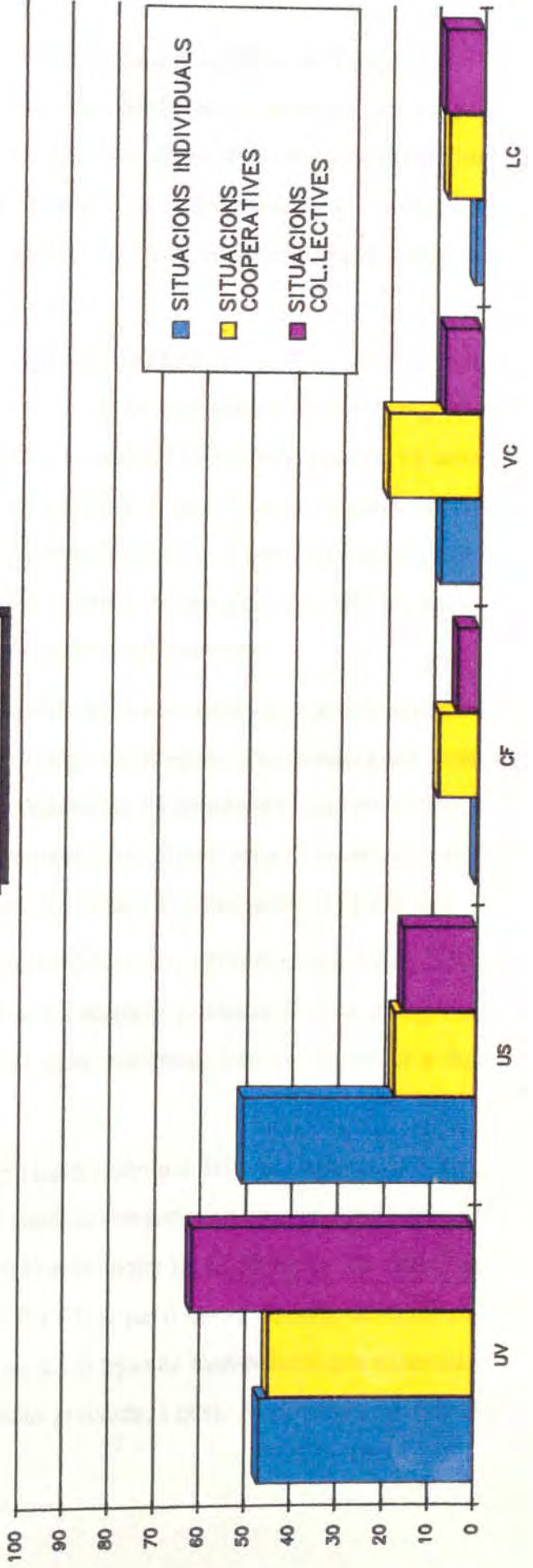

A partir de les primeres dades de tipus descriptiu, hem procedit a la recategorització del sistema de categories. La recategorització consisteix en agrupar en una mateixa categoria de conductes les que abans hem assignat categories diverses. Anomenem "categories components" a les categories inicials, i "categories producte" a les finals. Per realitzar aquest procés podíem seguir diferents criteris, obtenint així diversos tipus de recategorització:

La recategorització sinònima (Bakeman, 1983) suposa una transformació no biunívoca en la què a cada ocurrència d'unes categories originalment diferents, a partir d'ara se li assignarà la mateixa categoria. La nova categoria pot ser una ja existent o bé una de nova. Aquest tipus de recategorització suposa una reducció de les categories intra-subsistema. Com a resultat d'aquest procés es redueix considerablement el nombre de categories, ja que les noves categories han de ser també exhaustives i mútuament excloents.

La recategorització seqüencial (Bakeman, 1983) és una transformació que assigna una categoria producte a dues o més categories components que tenen lloc de forma consecutiva en un ordre determinat. La categoria producte representa una seqüència de categories en esdeveniment-base. Aquest tipus de recategorització va bé per indagar l'existència de seqüències d'ordre alt en unes dades tipus I.

La re-categorització simultània (Bakeman, 1978, Anguera, 1981, 1985) serà la transformació que assigna una categoria producte a dues categories components que co-ocorren, aquestes dues categories han de pertanyer a dos sistemes diferents.

S'ha realitzat la recategorització sinònima dels sistemes UV, US, CF, VC i LC amb la doble finalitat de suprimir categories conductuals de freqüència molt baixa i d'obtenir una classificació més molar de la conducta. El criteri de classificació ha estat en UV, CF, VC i CL a qui o on va dirigida la conducta. (mestre, nen, treball, voltant, etc.), i en la US tipus de manipulació que es realitza (Afagar, manipulació fina, manipulació gruixuda, i cos). Així, vàrem obtenir el següent sistema de categories.

UV (UNITATS VISUALS)

UV33 (voltant) UV01, UV02, UV09, UV13

UV44 (nen) UV03, UV05, UV06, UV10

UV55 (mestre) UV04, UV07, UV11

UV66 (treball) UV15, UV16, UV17

CF (CONTACTE FÍSIC)

CF44 (nen) CF01, CF03, CF04

CF55 (mestre) CF02, CF05, CF06

VC (UNITATS VOCALS)

VC44 (nen) VC01, VC02, VC03, VC04, VC05, VC06

VC55 (mestre) VC08, VC10

VC77 (altre) VC07, VC09

US (ÚS D'OBJECTES)

US22 (agafar) US02, US03, US04, US05, US06

US13 (manipulació fina)

US88 (manipulació gruixuda) US07, US08, US10, US14

US99 (cos) US09, US11, US12

LC (LOCOMOTOR)

LC33 (aula) LC01, LC02, LC03, LC04, LC05, LC11

LC44 (altre) LC06, LC07, LC08, LC10

LC55 (mestre) LC09, LC12, LC14

Després de la recategorització hem obtingut els resultats globals que s'exposen en l'annex (10.4).

6.2.8.3.- Anàlisi seqüencial de retard.

Abans d'iniciar l'anàlisi, vam comprovar si existien variacions brusques intersessionals amb les probabilitats incondicionades de les conductes i, a partir d'aquí, vam concloure que es donava una constància intersessional acceptable, com a mínim, en aquelles conductes més probables i, així, vam iniciar l'anàlisi seqüencial de retard.

La necessitat d'investigar la conducta interactiva en diversos àmbits de la Psicologia, ha contribuït al desenvolupament de noves metodologies, com és el cas de l'anàlisi seqüencial de dades observacionals, desenvolupat en primer lloc en l'etologia. Un dels primers treballs en aquest camp que va utilitzar l'anàlisi de seqüències és l'estudi de Tinbergen (1951) sobre la conducta de festeig en el peix *Gasterosteus aculeatus*. Tinbergen va proposar un esquema determinista en el qual cada conducta de la femella anava seguida de la conducta del mascle, a la qual seguia una altra conducta específica de la femella, i així successivament; cada acció suposava un desencadenant per a l'acció de l'altre individu.

El mètode de retards va ser desenvolupat fonamentalment per Sackett (1974, 1979, 1980), i s'aplica a sistemes de categories conductuals que han estat enregistrades seqüencialment. Cada categoria o conducta es conceptualitza com una variable dicotòmica (ocurrència, no ocurrència) i la finalitat del mètode és obtenir la "trajectòria" de la probabilitat que succeeixi cadascuna de les conductes amb un conjunt de retards, en relació a cadascuna d'elles agafada com a criteri. Segons el tipus de dades seqüencials recollides, els retards poden ser discrets o continus.

Aquest mètode s'ha fet servir sobretot per analitzar conductes en el camp de l'etologia i de la psicologia, però molt poc en l'àmbit de la pedagogia.

El mètode parteix de la hipòtesi nul·la de la no dependència entre els esdeveniments seqüencials. S'agafa una conducta com a criteri en la hipòtesi que la mateixa pot activar o desencadenar les que segueixen. La comparació de les probabilitats condicionals, que depenen de l'ordre d'ocurrència de les conductes, i de les probabilitats incondicionals que depenen de la freqüència de cada categoria en el total de la sessió, permet descobrir quines són les conductes excitatòries, és a dir, aquelles en les que la probabilitat condicional supera significativament la incondicional. Si això fos així podríem establir patrons de conducta formats pels diferents retards. Aquests patrons permeten comprovar la seva variació o estabilitat intersessions entre diferents parts d'una sessió o entre diferents subjectes.

El nostre sistema de categories ens permet obtenir sens dubte dades observacionals tipus IV (seqüencials i amb paràmetre durada), les quals consisteixen en la incorporació de la durada corresponen a les conductes i configuracions conductuals pròpies de les dades tipus II, i que procedeixen, per tant, d'un sistema de categories no mútuament excloent. En el nostre cas, veiem que diferents nivells de conducta poden donar-se al mateix moment (unitats visuals, vocals, locomotores, etc.).

6.2.8.3.3.- Procés de reducció de dades i gràfiques polars.

Per portar a terme la nostra investigació s'ha procedit al procés de reducció de dades transformant les nostre unitats de conducta en marcs de conducta susceptibles d'observació i anàlisi seqüencial.

Els criteris que hem establert ja han estat esmentats amb anterioritat i són: unitats visuals, contactes físics, conducta vocal, ús d'objectes, unitats locomotores. En el registre de les unitats veiem que surten cadenes d'unitats des

locomotores. En el registre de les unitats veiem que surten cadenes d'unitats des d'una fins a cinc, encara que d'aquestes últimes n'hi ha molt poques. Si aquestes cadenes tenen una consistència estadística quant a freqüència i durada considerarem que constitueixen patrons de conducta.

En aquest apartat, no ens preocupa l'anàlisi de la seqüencialitat, com veurem en el següent, sinó aconseguir que la informació resultant sigui eficaç i clarificadora, fent que es redueixi considerablement el volum de dades obtingudes, les quals passaran a ser dades pel procés de reducció que suposarà la consecució d'uns pocs paràmetres indicatius sobre els quals hi haurà el pes interpretatiu. Aquests paràmetres resultants han d'obeir a la possible versatilitat de la situació, pel que serà necessari trobar una mesura reductora potent.

A partir dels valors Z , índexs relatius de dependència seqüencial, (Bakeman, 1978), o bé considerar l'aparició de conductes que s'aparellen amb la conducta criteri, pot fer-se servir l'estadístic introduït per Cochran (1954). La tècnica de Cochran es basa en el principi que la suma d'un nombre N de puntuacions Z independents es distribueix normalment amb $X = 0$ i $\sigma = N$, pel que anomenem Z_{sum} a l'estadístic $\sum_1^n z / \sqrt{n}$ (éssent n el nombre de retards), el qual, segons Sackett (1980) permet mesurar la tendència general al llarg dels retards, conductes o subjectes.

Així, partint dels valors de probabilitats condicionades en el nombre de retards que s'hagin considerat després de fixar la conducta criteri, es troben els Z_{sum} corresponents, la qual cosa possibilita el coneixement de dependència excitatòria o inhibidòria, reduint-se considerablement les dades, obtenint una matriu de Z_{sum} d'ordre $K(K-1)$ essent K el nombre de categories, i permeten visualitzar la relació de cada conducta amb cadascuna de les altres.

Però encara és possible una major reducció representant els valors en forma de coordenades polars, i per tant mitjançant vectors i angles. És a dir, que al distribuir-se les conductes en quadrants diferents segons el tipus de relació establerta en cada cas entre la conducta criteri i la d'apareo, és possible trobar la distància entre l'origen (0,0) de coordenades Z_{sum} i el punt d'intersecció (o radi),

el qual correspon a $\sqrt{X^2 - Y^2}$ (sent X el Zsum corresponent a la conducta criteri, i Y a la d'apareo), així com l'angle corresponent a un valor de l'Arc sen = Y / radi, després de tenir en compte el nombre de graus previs a adicionar o substraure en funció del quadrant de què es tracti. Això permet obtenir el valor mig de la longitud del vector i de l'angle corresponent a cada quadrant, així com les seves desviacions típiques. Tenint en compte el significat de cada quadrant:

I - Conducta criteri i conducta d'aparellament mútuament excitatòries.

II - Conducta criteri inhibidora i conducta d'aparellament excitatòria

III - Conducta criteri i conducta d'aparellament mútuament inhibidores.

IV - Conducta criteri excitatòria i conducta d'aparellament inhibidora.

seria possible obtenir una interpretació objectiva i depurada en tots els moments en què interessa estudiar la transformació de marcs de conducta.

Encara seria possible una reducció a nivell global, abarçant totes les conductes i mostrant les seves mitjanes dels quatre paràmetres bàsics: longitud del vector o radi, angle, i les seves desviacions típiques. Podríem també estudiar específicament l'autocontingència, al considerar separatament els retards parells i senars, i avaluar el seu efecte sobre les probabilitats creuades entre la conducta criteri i la d'aparellament.

En la situació empírica que plantegem, escollim una conducta criteri: UV (unitats visuals), o sigui, totes les categories conductuals dins d'aquest subsistema després de la recategorització, UV33 (voltant), UV44 (nen), UVC55 (mestre), UV66 (treball). Creiem que la conducta visual és la més significativa per què surt a totes les situacions d'una manera més o menys estable, i per tant, és una conducta que fàcilment desencadena les altres. En estudis futurs, les altres conductes podrien ser escollides, també, com conductes criteri.

Les dades recollides en les sessions corresponents es recullen en la Taula , i després d'haver-se realitzat una anàlisi seqüencial de retards (Sackett, 1978, 1979, 1980; Anguera, 1981, 1983) mitjançant la utilització del programa ASR (Quera, 1985) (Annex 10.3).

De tot el conjunt de dades, presentem, per explicar el procés, només les corresponents al problema: conducta criteri UV - conducta aparellada VC en situacions individuals. En els annexes hi sortiran els altres problemes que tenen com a conducta criteri UV.

En la taula que tenim a continuació, s'hi presenta la matriu de freqüències de retard corresponents al conjunt de sessions, havent-se enregistrat un total de 540 conductes.

Hem considerat el retard màxim (max lag) de 5 com a prudencial ja que la conducta estudiada no ofereix variabilitat suficient per estudiar més retards i no ens aportaria informació rellevant diferent de l'obtinguda en aquest retard.

MATRIU DE FREQUÈNCIES DE RETARD.

CONDUCTA CRITERI = UV33, SUBSISTEMA = UV

ANALISI CLASSE 2 TIPUS 1 SUBTIPUS 1 MODO 1

ULTIMA COLUMNA: FREQUÈNCIA D'APARELLAMENT DE LA CONDUCTA CRITERI EN CADA RETARD

PRIMERA FILA: FREQUÈNCIES TOTALS DE LES CONDUCTES

SEGONA FILA: TEMPS DE SIMULTANEITAT DE CADA CONDUCTA AMB LA CONDUCTA CRITERI

COND CV44 CV55 CV77 CV11 CV12 TOT:

TOT 6 7 61 0 466 540

SML 1 4 36 0 234 275

LAG

1 2 4 33 0 232 271

2 3 4 30 0 230 267

3 2 6 29 0 226 263

4 1 7 26 0 226 260

5 0 6 23 0 226 255

A partir de la conducta criteri UV33, obtenim la matriu de probabilitats de retard i la de Z de retards, considerant el nombre de retards 5 com a prudencial.

MATRIU DE PROBABILITATS DE RETARD.

CONDUCTA CRITERI = UV33, SUBSISTEMA = UV

ANALISI CLASSE 2 TIPUS 1 SUBTIPUS 1 MODO 1

SIGNIFICAT DELS SIGNES: + ACTIVADA - INHIBIDA

PRIMERA FILA: PROBABILITATS INCONDICIONADES DE LES CONDUCTES

SEGUNDA FILA: PROBABILITATS DE SIMULTANEITAT DE CADA CONDUCTA AMB LA CONDUCTA CRITERI

PROBABILITATS INCONDICIONADES DE LA CONDUCTA CRITERI

PROB. DISCRETA = 0.406 PROB. CONTINUA = 0.509

COND CV44 CV55 CV77 CV11 CV12

INC 0.0111 0.0130 0.1130 0.0000 0.8630

SML 0.0036 0.0145 0.1309 0.0000 0.8509

LAG

1 0.0074 0.0148 0.1218 0.0000 0.8561

2 0.0112 0.0150 0.1124 0.0000 0.8614

3 0.0076 0.0228 0.1103 0.0000 0.8593

4 0.0038 +0.0269 0.1000 0.0000 0.8692

5 0.0000 0.0235 0.0902 0.0000 0.8863

MATRIU DE ZETES DE RETARD.

CONDUCTA CRITERI = UV33, SUBSISTEMA = UV

ANALISI CLASSE 2 TIPUS 1 SUBTIPUS 1 MODO 1

INDEXS GLOBALS CALCULATS:

MAG: MAGNITUD MITJA DE LA CONTINGENCIA

CIC: CICLICITAT MITJA DE LA CONTINGENCIA

ZSU: ZSUMA

COND CV44 CV55 CV77 CV11 CV12

LAG

1 -0.59 0.26 0.46 0.00 -0.33

2 0.02 0.29 -0.03 0.00 -0.07

3 -0.54 1.41 -0.14 0.00 -0.17

4 -1.12 1.99 -0.66 0.00 0.29

5 -1.69 1.49 -1.15 0.00 1.08

MAG 0.79 1.09 0.49 0.00 0.39

CIC 0.58 0.56 0.40 0.00 0.40

ZSU -1.75 2.44 -0.68 0.00 0.36

Amb la inspecció visual de la matriu de probabilitats de retard i de la matriu de zetes de retard i el càlcul de bandes de confiança corresponents obtindriem

els patrons de conducta en cadascuna de les situacions. Nosaltres, per identificar els patrons de conducta, hem procedit a la representació gràfica de les probabilitats condicionades (Annex 10.5) i, visualment, ens adonem de quins patrons de conducta hi ha per a cada conducta escollida com a criteri. Escollim les categories que han resultat significatives o excitatòries en cadascun dels succesius retards. El patró de conducta es va diluïnt quan passa al retard 3. Convencionalment, es considera que el l'últim retard abans de la segona ramificació successiva -anomenat MAX LAG- pràcticament acaba el patró de conducta que consta de dos nivells: la conducta criteri i les primeres conductes aparellades.

Els antecedents al voltant de la reducció de dades en l'àmbit dels marcs de conducta són migrats. Només Sackett (1980) i Anguera (1985) ho fan. Sackett (1980) pretenia aconseguir la reducció de dades en una situació en la qual podria considerar-se una única conducta en un grup de subjectes i Anguera (1985) volia, a partir de registres procedents d'una situació empírica, portar a terme una reducció dràstica de dades mitjançant la transformació a coordenades polars de valors corresponents al paràmetre Z_{sum} de conducta criteri i conductes d'aparellament un cop obtingudes les matrius de zetes de retard trobades en l'anàlisi seqüencial, seguint la tècnica de formats de camp en la fase de registre.

En la següents taules s'inclouen: el valors Z_{sum} per cadascuna de les situacions -individuals, col.lectives i cooperatives, agafant algunes conductes com a criteri i altres com a aparellament; els càlculs de vectors i àngles corresponents a les conductes criteri; i el gràfic polar corresponent a la mitjana entre vectors i àngles que mostren la relació de cada conducta criteri amb les altres.

CRITERI

	VC44	VC55	VC77	VC12	US22	US88	US99	US13	US15	CF07	CF44	LC33	LC44	LC18	UV33	UV44	UV55	UV66	UV12
CV44	-1.48	-0.68	-1.94	1.68	0.67	-1.08	-1.78	-1.46	5.21			-0.89	-0.58	0.62	-1.75	4.26	-0.36	-1.71	-0.91
CV55	-1.60	0.52	9.98	-3.33	5.46	-1.17	-1.92	-1.23	-2.60			-0.96	-0.63	0.67	2.44	-0.67	-1.28	-1.85	-0.98
CV77	2.48	-1.75	-9.17	-1.71	-1.02	7.22	6.27	-2.76	-1.12			-2.23	4.97	1.04	-0.68	1.29	-3.68	0.01	8.09
CV12	3.26	1.64	-11.14	2.15	-0.66	-5.93	-4.60	3.39	0.29			2.64	-4.19	-1.37	0.36	-2.26	3.91	0.47	-6.85
SU22	-10.74	-2.03	-8.87	0.00	9.25	-7.76	-8.50	-0.79	-1.78	-1.33	7.72	-2.47	4.82	-0.94	1.97	2.83	-5.08	-12.58	9.73
SU88	2.91	-1.38	7.98	0.00	1.56	15.42	-3.62	-1.82	-2.75	0.66	-1.36	-1.80	-1.18	0.18	-6.09	7.88	-2.40	5.29	-1.84
SU99	-7.20	6.38	11.00	0.00	-4.93	1.75	24.81	-10.49	0.50	0.32	-3.25	8.33	-2.82	-0.77	0.72	1.10	1.72	-2.96	-4.39
SU13	18.11	-2.22	-3.86	0.00	-6.71	-2.75	-10.88	13.42	0.81	0.69	-4.10	-5.43	-1.55	1.85	0.92	-9.45	4.21	15.45	-5.54
SU15	-3.15	-1.44	-0.03	0.00	1.02	5.48	1.00	-5.14	4.03	0.32	-1.42	3.14	-1.23	-0.22	-1.98	4.47	1.70	-3.63	-0.84
FC07	0.00	0.00	0.00	0.00	0.67	1.33	2.18	-2.59	1.23			1.09	-3.57	0.52	1.91	2.50	-0.61	2.10	-17.04
FC44	-1.82	2.67	0.00	0.14	-0.67	-1.33	-2.18	2.59	-1.23			-1.09	3.57	-0.52	-1.91	-2.50	0.61	-2.10	17.04
CL33	-1.35	-0.62	3.93	-0.83	-0.89	14.32	0.88	-2.82	-1.71			2.93	-0.53	-0.09	3.69	-2.69	-1.08	-1.56	-0.83
CL44	-1.92	0.38	-1.30	1.52	1.84	-1.40	-2.30	3.10	-3.11			-1.15	3.3	0.35	-1.68	-2.50	-1.53	-2.21	23.78
CL18	1.18	0.51	-2.09	-0.12	0.23	-7.54	0.87	-0.61	2.14			-0.01	-1.56	-0.42	0.81	1.26	2.35	0.63	14.86
VU33	7.47	0.36	-5.76	-1.06	-2.49	-3.33	-3.33	8.53	-5.95	-0.65	-2.03	-4.97	0.04	0.01	-1.91	0.06	-5.41	4.91	0.69
VU44	-3.79	-0.76	8.01	-1.84	3.26	5.27	4.35	-4.09	-4.20	0.21	-0.77	8.06	-1.21	-1.58	0.89	1.33	-4.91	-0.10	-1.81
VU55	-3.39	-1.35	3.19	0.72	4.94	-2.47	-4.07	-6.63	7.99	-0.37	8.13	-2.03	4.25	0.78	1.91	-1.44	2.36	-3.91	5.16
VU66	-4.06	2.13	-4.70	3.77	-3.78	0.33	-1.53	-2.74	11.07	1.02	-1.84	-2.43	-1.59	1.69	0.17	-1.52	15.86	-4.68	-2.48
VU14	-1.35	-0.62	-0.06	0.84	-2.37	0.99	12.09	-2.82	-1.29	0.34	-0.61	1.69	-0.53	0.14	0.04	2.16	-1.08	-1.56	-0.83

APARELLAMENT

SITUACIONS INDIVIDUALS
Zsum

CÀLCUL DE VECTORS I ÀNGLES CORRESPONENTS A LA CONDUCTA CRITERI "UV33"
 (Situacions individuals)

CONDUCTA	Zsum globals		Quadrant	Valors de les coordenades polars		
	Criteri (x)	Apareo (y)	O (origen)	Radi	Arcsen θ	Angle (θ)
VC44	-1.75	7.47	II (-180)	7.67	75.93	104.07
VC55	2.44	0.36	I (0)	2.46	8.39	8.39
VC77	-0.68	-5.76	III (+180)	5.8	81.89	261.89
VC12	0.36	-1.06	IV (-360)	1.12	71.80	288.2
US22	1.97	-2.49	IV (-360)	3.16	52.18	307.82
US88	-6.09	-3.33	II (-180)	6.94	28.68	208.68
US99	0.72	-3.33	III (+180)	3.41	77.42	282.58
US13	0.92	8.53	IV (-360)	8.58	83.72	83.72
US15	-1.98	-5.95	I (0)	6.27	71.62	251.62
CF07	1.91	-0.65	III (+180)	2.02	18.78	341.22
CF44	-1.91	-2.03	IV (-360)	2.79	46.89	226.89
LC33	3.69	-4.97	III (+180)	6.19	53.13	306.87
LC44	-1.68	0.04	IV (-360)	1.68	1.14	178.85
LC18	0.81	0.01	II (-180)	0.81	0.68	0.68
UV33	-1.91	-1.91	III (+180)	2.70	44.43	224.43
UV44	0.89	0.06	I (0)	0.89	3.84	3.84
UV55	1.91	-5.41	IV (-360)	5.74	70.05	289.95
UV66	0.17	4.91	I (0)	4.91	90	90
Quadrant	N	\bar{X}	Radi σ	\bar{X}	Angle σ	
I	6	3.24	2.75	34.93	37.42	
II	2	4.67	2.99	141.46	37.39	
III	5	4.9	1.79	234.702	19.33	
IV	6	3.6	1.83	302.77	19.6	

GRÀFIC POLAR CORRESPONENT AL PROMIG DE VECTORS I ÀNGLES QUE MOSTREN LA RELACIÓ DE LA CONDUCTA "UV33" AMB TOTES LES ALTRES. LES CIRCUMFERÈNCIES CONCÈNTRIQUES PERMETEN 266
 MEDIR LA LONGITUD DEL VECTOR (INTERIOR=2 EXTERIOR=4, a escala). ELS RECTANGLES DONEN LA DESVIACIÓ TÍPICA. ELS ARCS TRAÇATS AL FINAL DELS VECTORS REPRESENTATIUS SIGNIFIQUEN LA DESVIACIÓ TÍPICA DE L'ÀNGLE.
 (Situacions individuals)

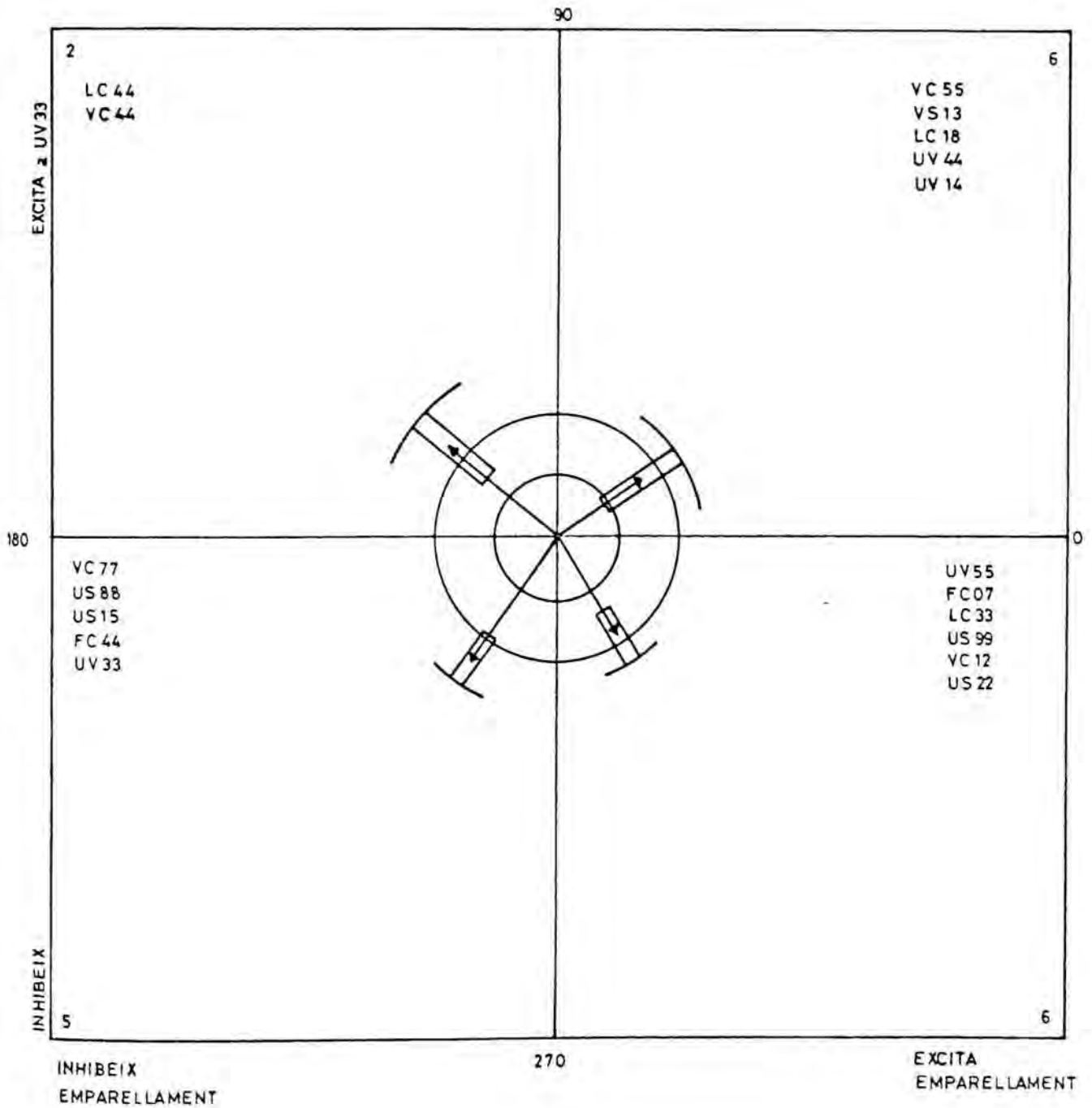

CÀLCUL DE VECTORS I ÀNGLES CORRESPONENTS A LA CONDUCTA CRITERI "UV44"
(Situacions individuals)

CONDUCTA	Zsum globals		Quadrant	Valors de les coordenades polars		
	Criteri (x)	Apareo (y)	O (origen)	Radi	Arcsen θ	Angle (θ)
VC44	4.26	-3.79	IV (-360)	5.7	41.29	318.71
VC55	-0.67	-0.76	III (+180)	3.85	10.95	190.65
VC77	1.29	8.01	I (0)	8.11	78.52	78.52
VC12	-2.26	-1.84	III (+180)	2.91	39.19	219.19
US22	2.83	3.26	I (0)	4.32	48.93	48.93
US88	7.38	5.27	I (0)	9.07	35.45	35.45
US99	0.72	-3.33	I (0)	4.49	75.46	75.46
US13	0.92	8.53	III (+180)	10.29	23.39	203.39
US15	-1.98	-5.95	IV (-360)	6.13	43.23	316.77
CF07	1.91	-0.65	I (0)	2.5	4.81	4.81
CF44	-1.91	-2.03	III (+180)	2.62	17.04	197.04
LC33	3.69	-4.97	II (-180)	8.49	71.62	108.38
LC44	-1.68	0.04	III (+180)	2.77	25.85	205.85
LC18	0.81	0.01	IV (-360)	2.02	51.44	308.56
UV33	-1.91	-1.91	I (0)	0.89	90	90
UV44	0.89	0.06	I (0)	1.88	44.99	44.99
UV55	-1.44	-4.91	III (+180)	5.12	80.06	260.06
UV66	-1.52	-0.10	III (+180)	1.52	3.72	181.52
Quadrant	N	\bar{X}	Radi σ	\bar{X}	Angle σ	
I	7	4.49	2.87	20.88	28.34	
II	1	8.49	2.87	108.38	28.34	
III	7	4.31	2.79	208.24	23.85	
IV	3	4.61	1.84	314.68	4.39	

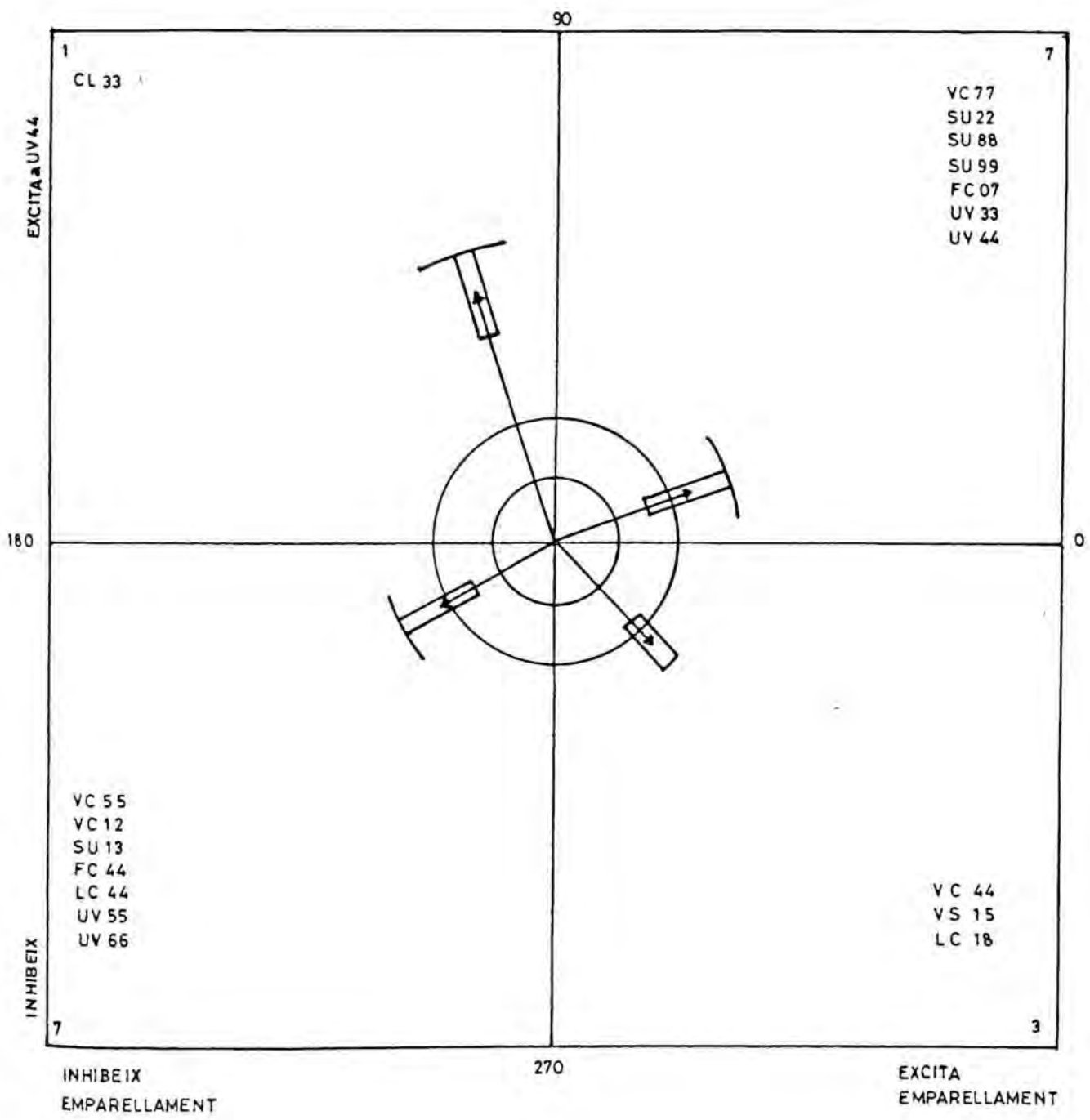

CÀLCUL DE VECTORS I ÀNGLES CORRESPONENTS A LA CONDUCTA CRITERI "UV55"
(Situacions individuals)

CONDUCTA	Zsum globals		Quadrant	Valors de les coordenades polars		
	Criteri (x)	Apereo (y)	O (origen)	Radi	Arcsen θ	Angle (θ)
VC44	-0.36	-3.39	III (+180)	3.41	83.72	263.72
VC55	-1.28	-1.55	III (+180)	2.01	50.44	230.44
VC77	-3.68	3.19	II (-180)	4.87	40.91	139.08
VC12	3.91	0.72	I (0)	3.97	10.43	10.43
US22	-5.08	4.94	II (-180)	7.08	44.18	135.81
US88	-2.40	2.47	II (-180)	3.44	45.23	134.76
US99	1.72	-4.07	IV (-360)	4.42	66.93	293.07
US13	4.21	-6.63	IV (-360)	7.85	55.56	302.43
US15	1.70	7.99	I (0)	8.17	77.68	77.68
CF07	-0.61	-0.37	III (+180)	0.71	31.39	211.39
CF44	0.61	8.13	I (0)	8.15	85.56	85.56
LC33	-1.08	-2.03	III (+180)	2.29	62.37	242.37
LC44	-1.53	4.25	II (-180)	4.52	70.05	109.95
LC18	2.35	0.78	I (0)	2.47	18.36	18.36
UV33	-5.41	1.91	II (-180)	5.74	19.39	160.61
UV44	-4.91	-1.44	III (+180)	5.12	16.32	196.32
UV55	2.36	2.36	I (0)	3.34	44.91	44.91
UV66	15.96	-3.91	IV (-360)	16.33	13.82	346.17
Quadrant	N	\bar{x}	Radi σ	\bar{x}	Angle σ	
I	5	5.22	2.44	47.37	30.29	
II	5	6.04	2.66	136.04	16.09	
III	5	2.07	1.48	228.85	23.51	
IV	3	9.53	5.00	313.89	23.14	

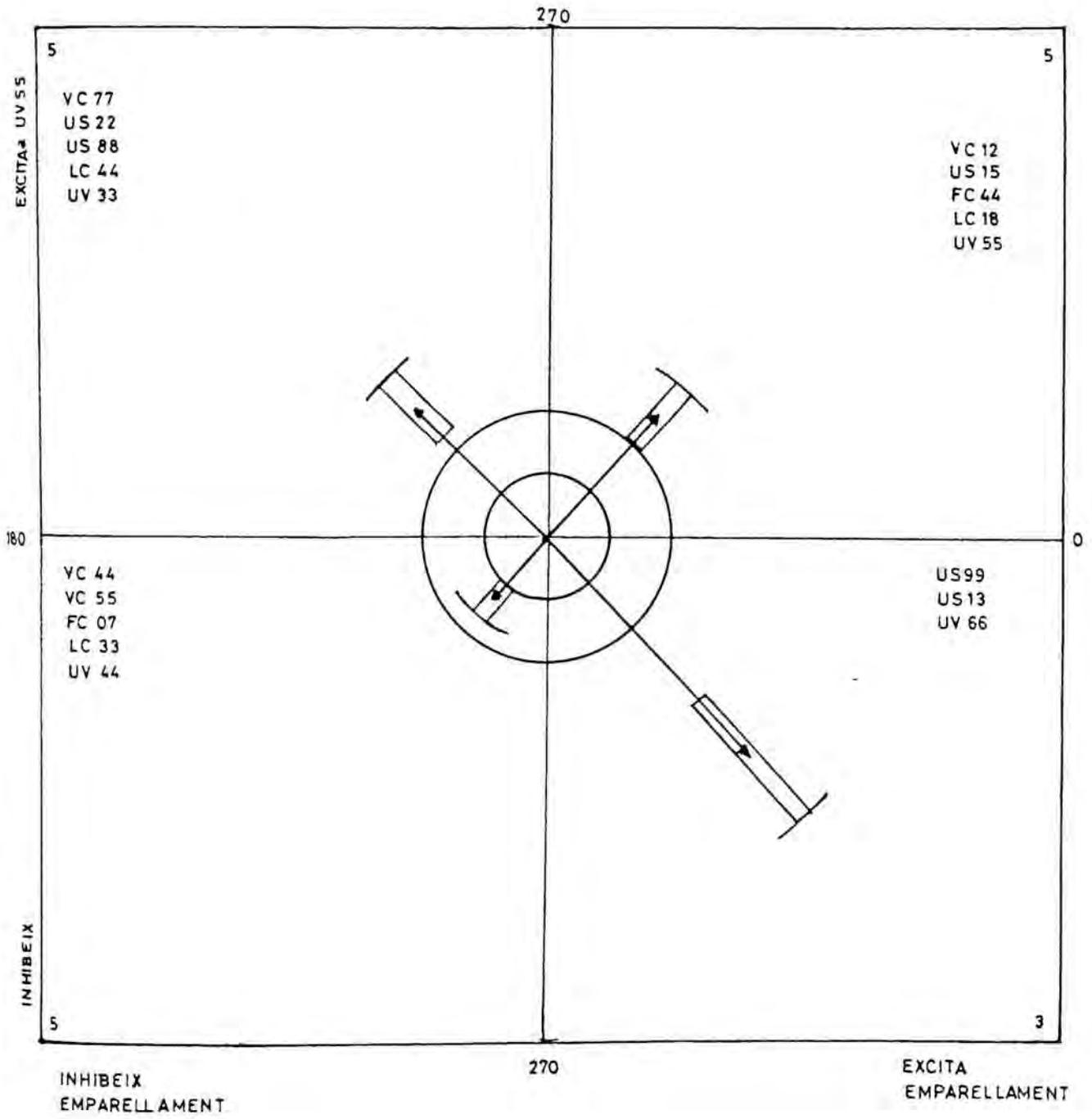

CÀLCUL DE VECTORS I ÀNGLES CORRESPONENTS A LA CONDUCTA CRITERI "UV66"
 (Situacions individuals)

CONDUCTA	Zsum globals		Quadrant	Valors de les coordenades polars		
	Criteri (x)	Apereo (y)	O (origen)	Radi	Arcsen θ'	Angle (θ)
VC44	-1.71	-4.06	III (+180)	4.40	66.92	246.93
VC55	-1.85	2.13	II (-180)	2.82	49.25	130.97
VC77	0.71	-4.70	IV (-360)	4.75	81.49	278.50
VC12	0.47	3.77	I (0)	3.79	83.72	83.72
US22	-12.58	-3.78	III (+180)	13.13	16.67	196.68
US88	5.29	0.33	I (0)	5.30	3.55	3.55
US99	-2.96	-1.53	III (+180)	3.33	27.32	207.32
US13	15.45	-2.74	IV (-360)	15.69	10.02	349.97
US15	-3.63	11.07	II (-180)	11.65	71.80	108.19
CF07	2.10	1.02	I (0)	2.33	25.97	25.97
CF44	-2.10	-1.84	III (+180)	2.79	41.22	221.22
LC33	3.69	-4.97	II (-180)	2.88	57.46	237.46
LC44	-1.68	0.04	III (+180)	2.72	35.73	215.73
LC18	0.81	0.01	IV (-360)	1.80	69.71	69.71
UV33	-1.91	-1.91	I (0)	4.91	1.94	1.94
UV44	0.89	0.06	I (0)	1.52	90	270
UV55	-1.44	-4.91	III (+180)	16.33	76.16	103.83
UV66	-1.52	-0.10	III (+180)	6.61	45.07	225.07
Quadrant	N	\bar{X}	Radi σ	\bar{X}	Angle σ	
I	5	3.63	1.37	36.97		33.83
II	3	10.27	5.60	114.33		11.90
III	8	4.67	3.49	227.55		21.86
IV	2	10.22	5.47	314.23		35.73

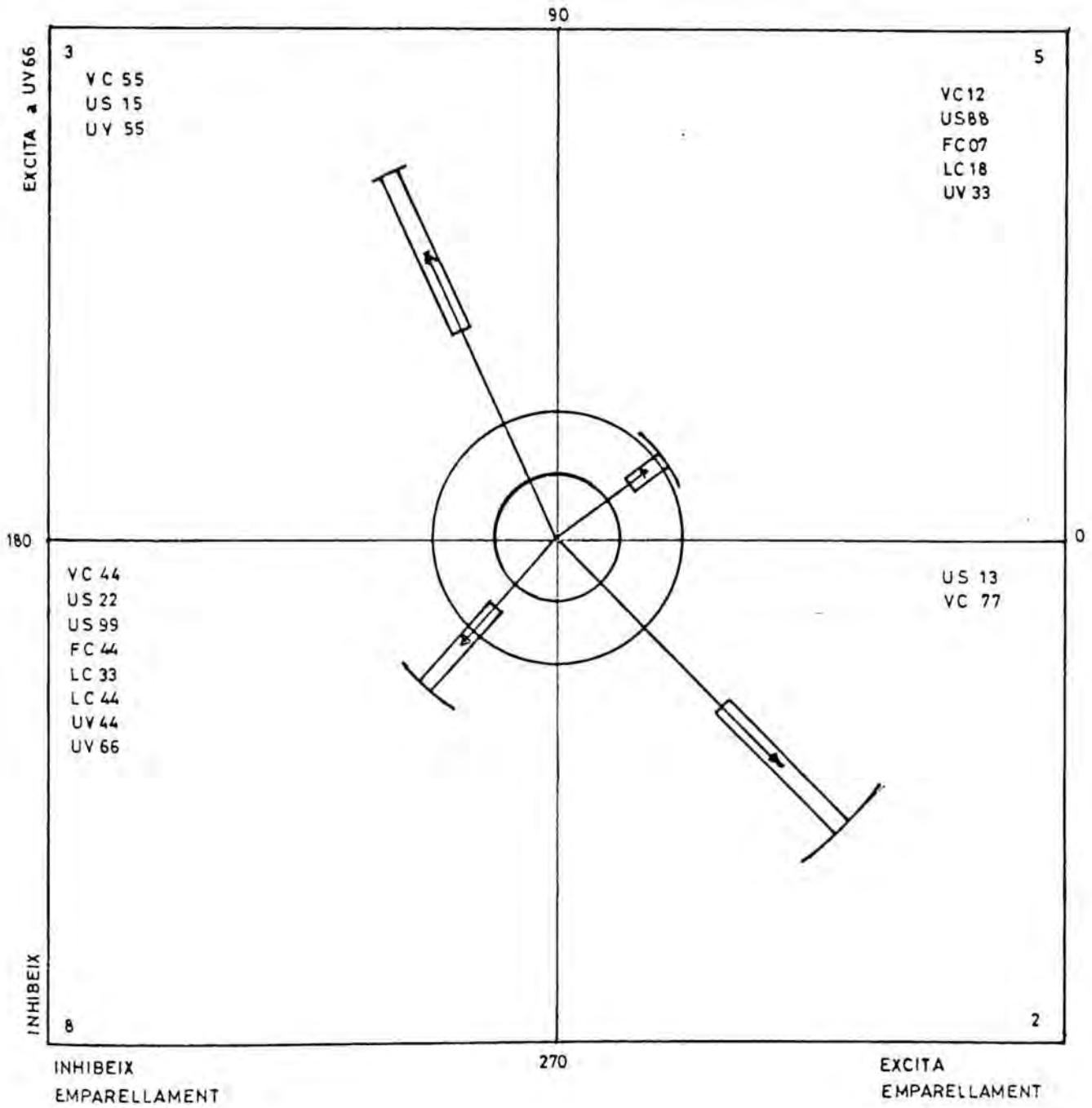

CRITERI

	VC44	VC55	VC77	VC12	US22	US88	US99	US13	US15	CF07	CF44	CF55	LC33	LC44	LC18	UV33	UV44	UV55	UV66	UV14
CV44	-1.60	-1.93	6.29	-1.28	-1.62	-2.15	-0.83	-1.47	1.26				-0.20	4.89	-1.66	-4.40	6.84	-4.54		0.01
CV55	-0.86	5.90	-3.65	-0.32	0.79	-2.20	-1.01	0.02	0.03				1.97	-2.49	0.36	-1.88	2.44	-1.45		-0.62
CV77	0.20	1.75	-0.38	0.03	-2.07	-1.83	-0.71	-1.25	2.27				-0.95	1.11	0.45	-2.32	1.31	-0.11		3.71
CV12	1.46	-3.93	-0.98	0.98	1.47	3.78	1.58	1.52	-1.95				-0.79	-1.73	0.51	5.16	-6.50	3.80		-1.48
SU22	-2.93	0.51	-5.75	2.54	30.97	-3.64	-1.52	2.98	-17.25	4.40	-8.22	-4.14	4.45	-2.59	-1.90	3.52	-3.85	3.57		-4.62
SU88	-1.11	-1.89	-2.52	1.84	2.12	-1.50	-0.58	4.96	0.86	1.37	-1.49	-1.58	0.26	-2.81	1.79	2.03	-4.36	5.40		-1.76
SU99	-1.74	-2.95	2.83	0.85	-6.10	-2.34	-0.91	-1.61	5.32	3.01	-4.66	-2.46	-2.05	-4.39	3.18	-6.78	-5.85	17.60		-2.75
SU13	-0.38	-0.64	2.61	-0.41	-0.80	-0.51	-0.20	-0.35	0.86	0.67	-1.06	-0.53	-0.44	-0.95	0.69	1.63	-0.60	-0.27		-0.60
SU15	3.89	1.99	3.86	-3.24	-23.36	4.98	2.03	-3.40	11.77	-5.97	10.20	5.51	-2.64	5.78	-0.92	-0.16	8.18	-14.50		6.14
FC07	2.03	-2.53	2.23	-1.02	6.54	2.88	1.47	2.61	-5.80				-0.90	-11.72	3.09	8.04	-2.58	-2.79	1.60	
FC44	-2.49	3.82	-2.25	0.58	-9.60	-2.34	-1.30	-2.30	7.12				-2.93	14.24	-3.55	-9.78	2.16	5.50	-1.41	
FC55	0.51	-2.00	-0.39	1.04	4.64	-1.59	-0.61	-1.09	-1.42				7.51	-2.62	0.29	1.83	1.29	-4.68	-0.67	
CL33	1.71	-1.89	-2.52	0.50	2.37	-1.50	-0.58	-1.03	-1.27				-0.53	-2.09	0.69	0.48	0.03	-2.84	1.00	3.48
CL44	-2.32	4.56	2.13	-0.71	-2.60	-3.12	-1.21	-2.14	3.22				-2.73	11.63	-2.72	-5.12	3.87	2.19	-0.46	-2.42
CL18	-1.59	-2.53	0.29	0.15	1.02	3.59	1.51	2.23	-2.37				3.06	-8.80	1.75	3.78	-3.78	0.01	0.20	0.42
VU33	8.93	3.77	18.61	72.81	74.67	46.00	24.59	31.36	29.98	80.89	-0.22	0.78	9.31	13.81	67.68	93.66	20.85	24.21	12.16	1.70
VU44	-1.24	3.58	5.90	-2.97	-9.50	-5.62	-3.77	-6.05	6.56	-1.75	3.09	0.07	-0.32	0.82	0.10	-9.04	6.81	-2.03	-2.54	3.55
VU55	-5.96	-6.79	-13.18	-31.23	-14.29	-7.92	-3.15	-2.72	-30.32	-32.04	12.49	-5.64	-5.87	-11.89	-31.41	-20.07	-22.72	-15.83	-0.82	-7.52
VU66	0.17	3.21	2.27	12.73	23.40	12.99	-0.09	-0.16	-0.31	11.28	-0.47	16.44	9.88	1.88	12.12	12.16	9.91	0.76	-0.10	-0.27
VU14	22.91	9.81	4.74	52.08	1.60	-0.95	-0.37	-0.65	64.23	38.68	44.06	22.37	15.02	34.63	43.78	8.15	41.81	38.27	-0.40	17.21

SITUACIONS COLLECTIVES
Zsum

APARELLAMENT

CÀLCUL DE VECTORS I ÀNGLES CORRESPONENTS A LA CONDUCTA CRITERI "UV33"

(Situacions col.lectives)

CONDUCTA	Zsum globals		Quadrant	Valors de les coordenades polars		
	Criteri (x)	Apareo (y)	O (origen)	Radi	Arcsen θ	Angle (θ)
VC44	-4.40	8.93	II (-180)	9.95	63.76	116.23
VC55	-1.88	3.77	II (-180)	4.21	63.50	116.49
VC77	-2.32	18.61	II (-180)	18.75	82.74	97.25
VC12	5.16	72.81	I (0)	72.99	85.56	85.56
US22	3.52	74.67	I (0)	74.75	86.37	86.37
US88	2.03	46.00	I (0)	46.04	87.43	87.43
US99	-6.78	24.59	II (-180)	25.5	74.57	105.42
US13	1.63	31.36	I (0)	31.40	86.37	86.37
US15	-0.16	29.98	II (-180)	29.98	90	90
CF07	8.04	80.89	I (0)	81.28	84.26	84.26
CF44	-9.78	-0.22	III (+180)	9.78	1.26	181.26
CF55	1.83	0.78	I (0)	1.98	23.14	23.14
LC33	0.48	9.31	I (0)	9.32	86.37	86.37
LC44	-5.12	13.81	II (-180)	14.72	69.71	110.28
LC18	3.78	67.68	I (0)	67.78	86.37	86.37
UV33	93.66	93.66	I (0)	132.45	44.99	44.99
UV44	-9.04	20.85	II (-180)	22.72	66.49	113.50
UV55	-20.07	24.21	II (-180)	31.44	50.35	129.64
UV66	12.16	12.16	I (0)	17.19	44.99	44.99
UV14	8.15	1.70	I (0)	8.32	11.77	11.77
Quadrant	N	\bar{X}	Radi σ	\bar{X}	Angle σ	
I	11	49.41	38.57	66.14	27.79	
II	8	19.65	8.99	109.85	11.52	
III	1	9.78	0	181.26	0	
IV	0	0	0	0	0	

90

8

VC44
VC55
VC77
US99
US15
LC44
UV44
UV55

EXCITA 8 UV33

11

VC 12
US 22
US 88
US 13
FC 07
LC 33
LC 78
UV 33
UV 66
UV 14
FC 55

FC 44

25

EXCITA 8 UV33

0

CÀLCUL DE VECTORS I ÀNGLES CORRESPONENTS A LA CONDUCTA CRITERI "UV44"
(Situacions col·lectives)

CONDUCTA	Zsum globals		Quadrant	Valors de les coordenades polars		
	Criteri (x)	Apareo (y)	O (origen)	Radi	Arcsen θ'	Angle (θ)
VC44	6.84	-1.24	IV (-360)	6.95	10.256	349.74
VC55	2.44	3.58	I (0)	4.33	55.69	55.69
VC77	1.31	5.90	I (0)	6.04	77.42	77.42
VC12	-6.50	-2.97	III (+180)	7.14	24.51	204.52
US22	-3.85	-9.50	III (+180)	10.25	67.81	247.82
US88	-4.36	-5.62	III (+180)	7.11	52.18	232.18
US99	-5.85	-3.77	III (+180)	6.95	32.81	212.81
US13	-0.60	-6.05	III (+180)	6.07	84.87	264.87
US15	8.18	6.56	I (0)	10.48	38.68	38.68
CF07	-2.58	-1.75	III (+180)	3.11	34.19	214.19
CF44	2.16	3.09	I (0)	3.77	54.98	54.98
CF55	1.29	0.07	I (0)	1.29	3.09	3.09
LC33	0.03	-0.32	IV (-360)	0.32	90	270
LC44	3.87	0.82	I (0)	3.95	11.94	11.94
LC18	-3.78	0.10	II (-180)	3.78	1.48	178.51
UV33	20.85	-9.04	IV (-360)	22.72	23.39	336.60
UV44	6.81	6.81	I (0)	9.63	44.99	44.99
UV55	-22.72	-2.03	III (+180)	22.81	5.04	185.04
UV66	9.91	-2.54	IV (-360)	10.23	14.35	345.64
UV14	41.81	3.55	I (0)	41.96	4.81	4.81
Quadrant	N	\bar{X}	Radi σ	\bar{X}	Angle σ	
I	8	10.18	12.35	36.45	25.45	
II	1	3.78	0	178.51	0	
III	7	9.06	5.93	223.06	25.12	
IV	4	10.05	8.13	325.49	32.39	

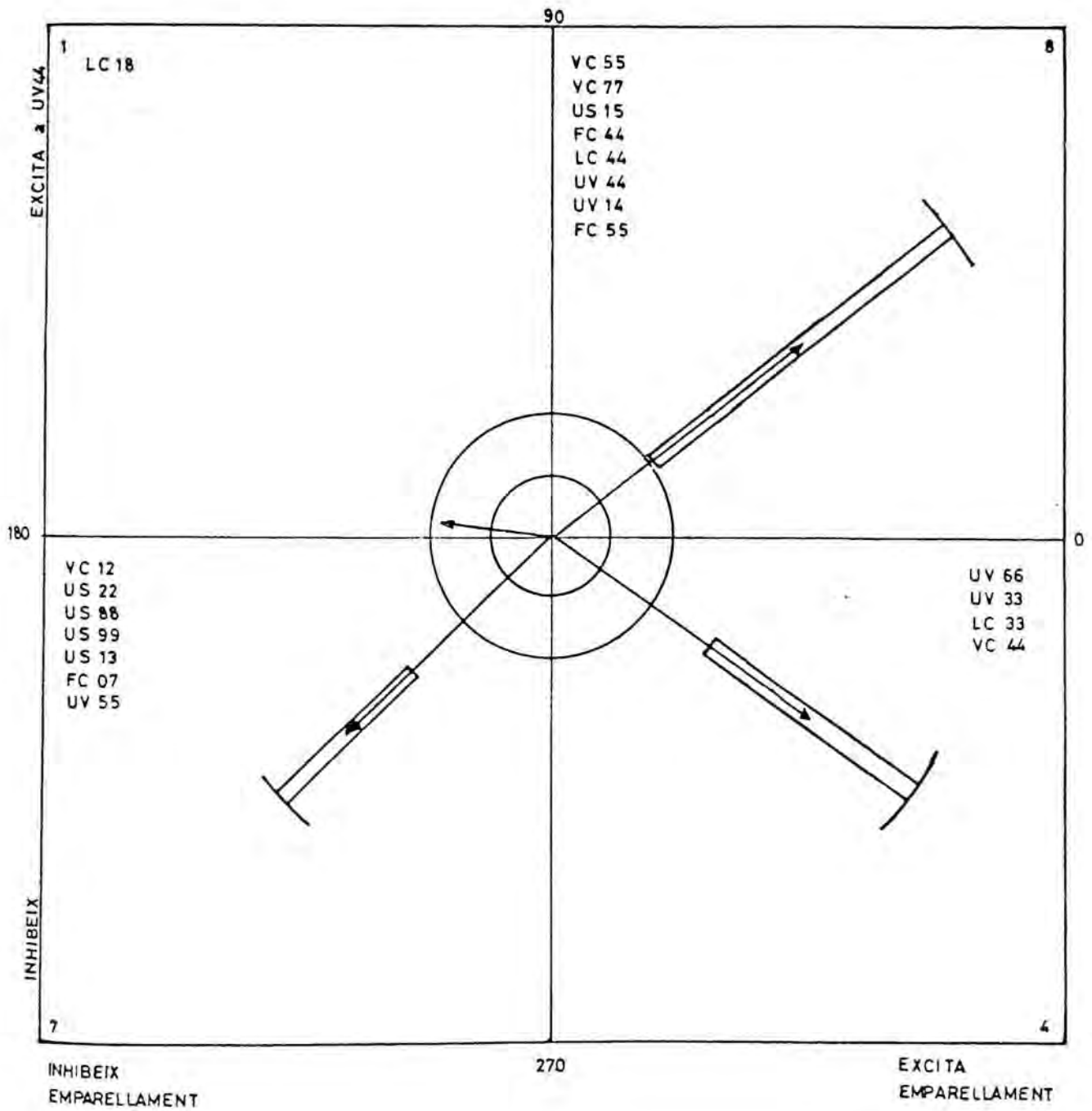

CÀLCUL DE VECTORS I ÀNGLES CORRESPONENTS A LA CONDUCTA CRITERI "UV55"
(Situacions col·lectives)

CONDUCTA	Zsum globals		Quadrant	Valors de les coordenades polars		
	Criteri (x)	Apareo (y)	O (origen)	Radi	Arcsen θ	Angle (θ)
VC44	-4.54	-5.96	III (+180)	7.49	52.65	232.65
VC55	-1.45	-6.79	III (+180)	6.94	77.95	257.95
VC77	-0.11	-18.18	III(+180)	13.18	90	270
VC12	3.80	-31.23	IV (-360)	31.46	82.74	277.25
US22	3.57	-14.29	IV (-360)	14.72	75.93	284.06
US88	5.40	-7.92	IV (-360)	9.58	55.58	304.41
US99	17.16	-3.15	IV (-360)	17.44	10.36	349.63
US13	-0.27	-2.72	III (+180)	2.73	84.87	264.87
US15	-14.50	-30.32	III (+180)	33.60	64.42	244.42
CF07	-2.79	-32.04	III (+180)	32.16	84.87	264.87
CF44	5.50	-12.49	IV(-360)	13.64	66.20	293.79
CF55	-4.68	-5.64	III (+180)	7.32	50.35	230.35
LC33	-2.84	-5.87	III (+180)	6.52	64.15	244.15
LC44	2.19	-11.89	IV (-360)	12.09	79.42	280.57
LC18	0.01	-31.41	IV (-360)	31.41	90	270
UV33	24.21	-20.07	IV (-360)	31.44	39.64	320.35
UV44	-2.03	-22.72	III (+180)	22.81	84.87	264.87
UV55	-15.83	-15.83	III (+180)	2238	44.99	224.99
UV66	0.76	-0.82	IV (-360)	1.11	47.56	312.43
UV14	38.27	-7.52	IV (-360)	39.00	10.95	349.04
Quadrant	N	\bar{X}	Radi σ	\bar{X}	Angle σ	
I	0	0	0	0	0	
II	0	0	0	0	0	
III	10	15.51	10.76	249.91	15.82	
IV	10	20.18	11.64	304.15	27.15	

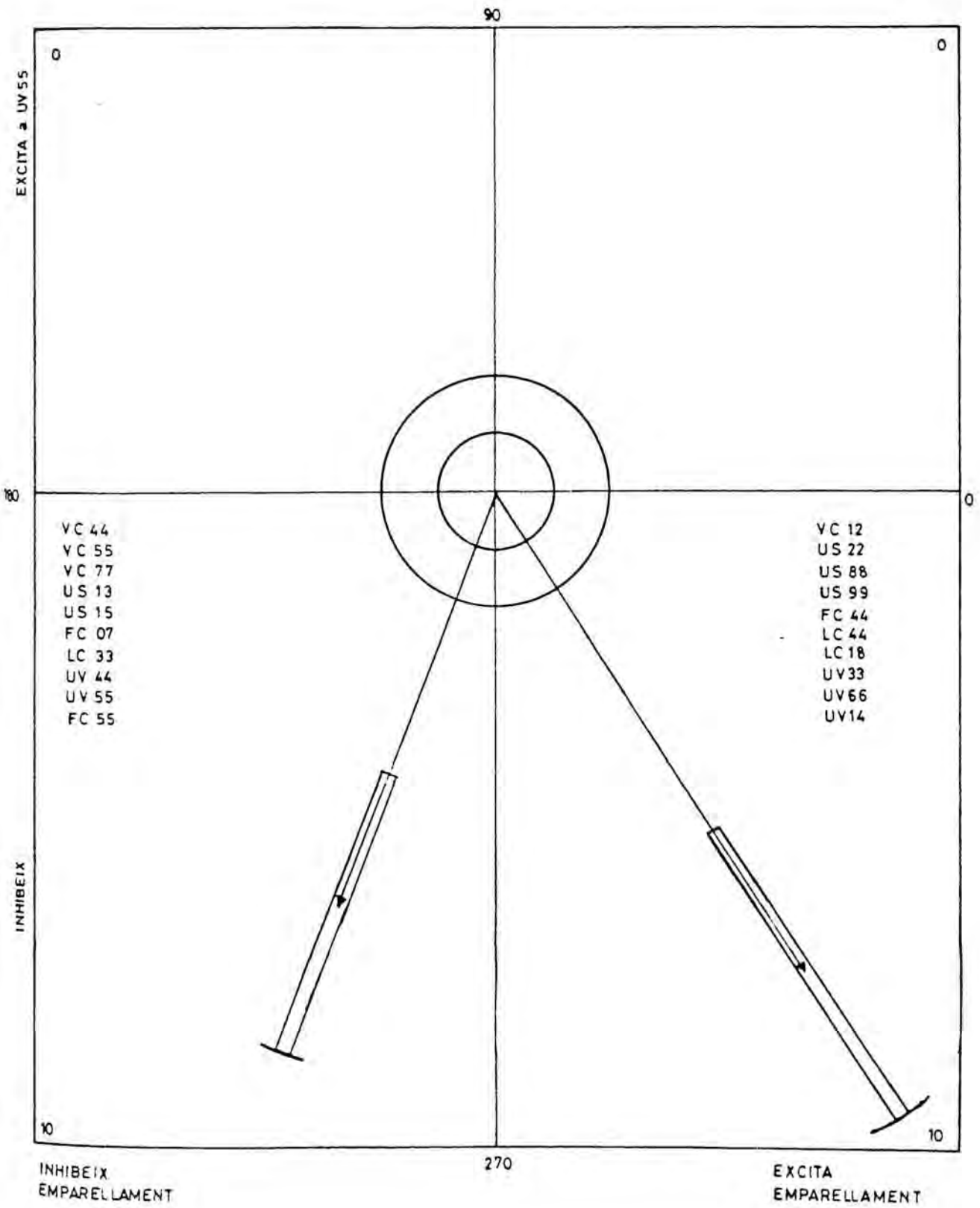

CÀLCUL DE VECTORS I ÀNGLES CORRESPONENTS A LA CONDUCTA CRITERI "UV66"
(Situacions col.lectives)

CONDUCTA	Zsum globals		Quadrant	Valors de les coordenades polars		
	Crteri (x)	Apareo (y)	O (origen)	Radi	Arcsen θ	Angle (θ)
VC44						
VC55						
VC77						
VC12						
US22						
US88						
US99						
US13						
US15						
CF07	1.60	11.28	I (0)	11.39	81.89	81.89
CF44	-1.41	-0.47	III (+180)	1.48	18.48	198.48
CF55	0.67	16.44	I (0)	16.45	87.43	87.43
LC33	-2.84	1.88	I (0)	9.93	83.72	83.72
LC44	2.19	-11.89	II (-180)	1.93	76.90	103.09
LC18	0.01	-31.41	I (0)	12.12	90	90
UV33	24.21	-20.07	I (0)	17.19	44.99	44.99
UV44	-2.03	-22.72	II (-180)	10.23	75.46	104.53
UV55	-15.83	-15.83	II (-180)	1.11	43.15	136.84
UV66	0.76	-0.82	III (+180)	0.14	45.56	225.56
UV14	38.27	-7.52	III (+180)	0.48	34.19	214.19
Quadrant	N	\bar{X}	Radi σ	\bar{X}	Angle σ	
I	5	13.41	2.87	77.60	16.55	
II	3	4.42	4.11	114.82	15.58	
III	3	0.7	0.56	212.74	11.10	
IV	0	0	0	0	0	

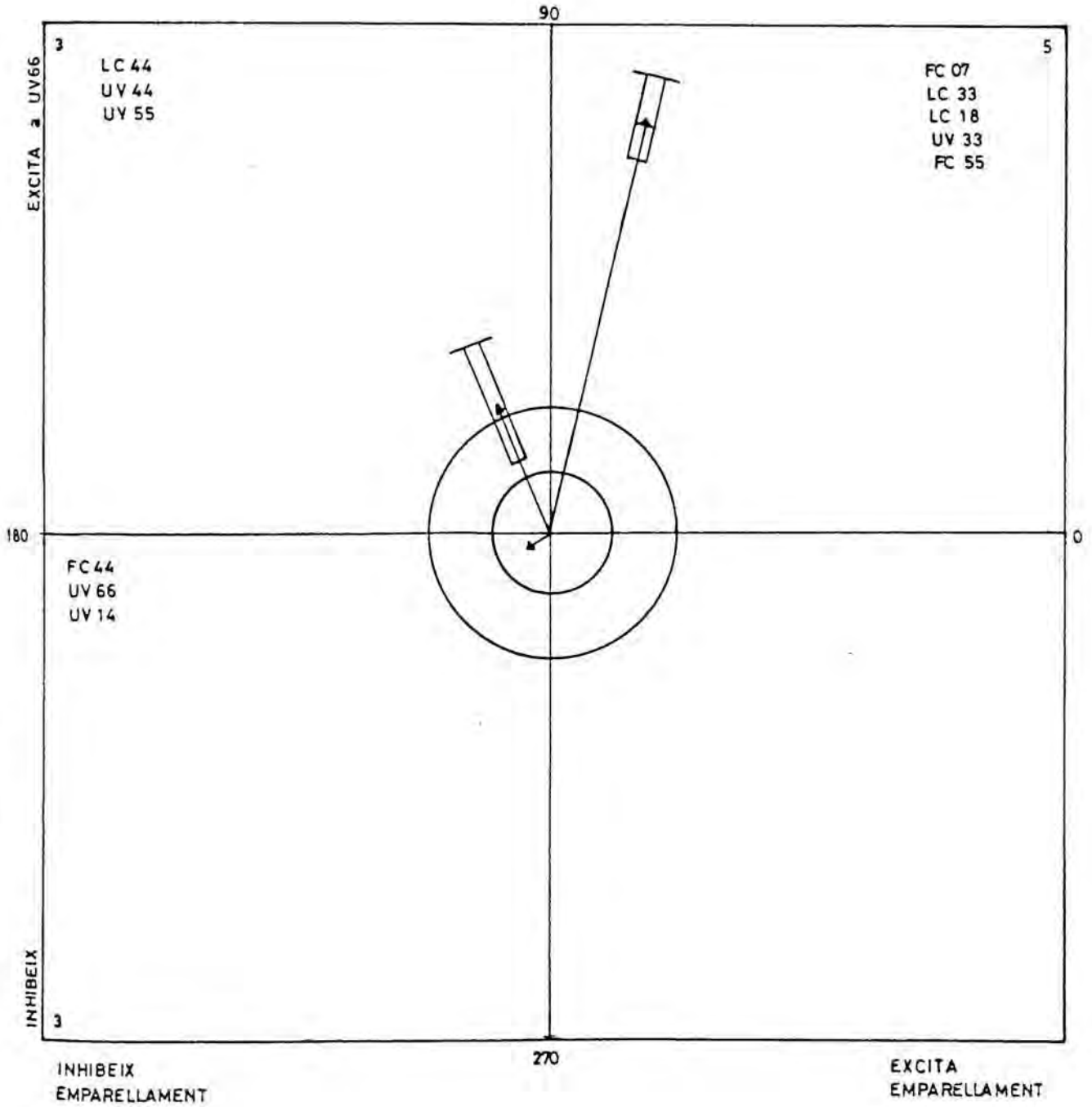

CRITERI	VC55	VC77	VC12	US22	US88	US13	US15	CF07	CF44	LC33	LC55	LC18	UV33	UV44	UV55	UV66
CV44	2.38	-1.51	0.78	-0.60	0.57	3.93	-1.10			-0.52	-1.05	1.06	2.58	-2.95	-0.19	2.03
CV55	8.26	-3.44	0.39	3.07	-1.24	-1.75	3.90			-0.85	1.30	-0.30	-2.89	-0.08	9.57	-2.36
CV77	-2.27	13.49	-7.98	0.73	-0.23	-1.74	3.61			-0.53	5.32	1.40	5.08	-0.27	-5.94	1.76
CV12	-1.01	-11.78	7.55	0.43	0.52	1.48	-4.61			0.91	-5.43	-1.06	-4.72	0.90	2.69	-1.37
SU22	-6.56	1.66	1.24	1.12	1.30	-3.52	-1.93	8.96	-12.57	-7.04	-5.16	3.74	8.50	-4.50	-6.74	-2.36
SU88	-2.65	3.07	-2.12	11.58	-1.51	2.40	-7.47	3.06	-5.44	-3.04	-2.08	0.61	5.52	-3.34	-3.01	-2.87
SU99	-1.70	-3.70	4.06	5.10	-0.97	-2.40	-0.57	2.81	-3.49	-1.95	-1.33	1.53	6.10	-3.74	-1.93	-1.84
SU13	-6.56	-2.38	4.78	0.51	-0.37	18.16	-9.33	9.27	-13.03	-7.55	-5.16	4.20	-7.25	2.87	-7.46	20.54
SU15	12.09	0.37	-5.14	-7.26	-0.42	-12.04	12.29	-16.69	23.75	13.50	9.51	-7.03	-4.73	3.49	13.22	-12.98
FC07	-8.62	8.03	-2.28	12.95	3.81	12.37	-14.94			-18.91	3.29	5.93	6.02	-1.77	-13.36	8.72
FC44	7.62	-7.80	2.43	-12.81	-3.76	-12.25	14.94			18.97	-3.21	-6.01	-6.25	2.04	13.40	-8.63
FC55	7.41	-1.84	-0.99	-1.31	-0.48	-1.19	1.84			0.04	-0.66	0.41	1.49	-1.86	0.09	-0.91
CL33	-3.23	-2.07	2.54	-6.09	-2.30	7.54	0.61			14.18	-3.17	-4.08	5.44	-1.88	-3.88	-3.63
CL44	-1.34	0.90	0.17	4.25	4.55	0.23	-3.23			-1.54	-1.05	0.76	0.94	1.18	-1.52	-1.45
CL18	5.13	-2.18	0.42	-2.46	1.80	-2.61	1.79			-8.73	-3.42	4.30	5.85	2.02	3.79	4.70
VU33	-10.80	0.03	2.61	8.92	-4.91	-4.49	-4.66	5.85	-10.45	-5.53	1.13	0.44	9.17	-2.06	-5.88	-15.39
VU44	9.28	2.05	-4.65	-6.49	-0.54	-7.55	9.55	-8.86	13.74	9.85	1.66	-3.16	-2.97	2.88	5.21	-2.50
VU55	18.55	-3.93	-3.09	-2.80	-1.03	-2.55	2.14	-4.33	6.75	-1.07	-1.42	1.28	-2.60	-2.94	14.85	-1.95
VU66	-4.35	-0.44	3.24	-3.46	6.97	20.81	-8.02	6.43	-7.82	-5.00	-3.42	3.92	-9.75	-0.08	-4.49	30.66
VU14	-1.34	-2.91	2.92	-0.12	7.21	-1.89	0.21	-1.57	2.77	-1.54	-1.05	-1.08	1.00	1.15	-1.52	-1.45

SITUACIONS COOPERATIVES
Zsum

APARELLAMENT

CÀLCUL DE VECTORS I ÀNGLES CORRESPONENTS A LA CONDUCTA CRITERI "UV33"
 (Situacions cooperatives)

CONDUCTA	Zsum globals		Quadrant	Valors de les coordenades polars		
	Criteria (x)	Apareo (y)		O (origen)	Radi	Arcsen θ
VC55	-2.39	-10.80	III (+180)	11.06	77.42	257.42
VC77	5.08	0.03	I (0)	5.08	0.28	0.28
VC12	-4.72	2.61	II (-180)	5.39	28.94	151.05
US22	8.50	8.92	I (0)	12.32	46.38	46.38
US88	5.52	-4.91	IV (-360)	7.38	41.68	318.31
US13	-7.25	-4.49	III (+180)	8.52	31.73	211.73
US15	-4.73	-4.66	III (+180)	6.63	44.58	224.58
CF07	6.02	5.85	I (0)	8.38	44.18	44.18
CF44	-6.25	-10.45	III (+180)	12.17	59.09	239.09
LC33	5.44	-5.53	IV (-360)	7.75	45.47	314.52
LC44	0.94	1.13	I (0)	1.46	50.62	50.62
LC18	5.85	0.44	I (0)	5.86	4.3	4.3
UV33	9.17	9.17	I (0)	12.96	44.99	44.99
UV44	-2.97	-2.06	III (+180)	3.61	34.75	214.75
UV55	2.60	-5.88	IV (-360)	6.42	66.20	293.79
UV66	-9.75	-15.39	III (+180)	18.21	57.67	237.67
Quadrant	N	\bar{x}	Radi σ	\bar{x}	Angle σ	
I	6	7.84	4.10	31.79	20.99	
II	1	5.39	0	151.05	0	
III	6	10.03	4.61	230.87	15.72	
IV	3	7.18	0.56	308.87	10.77	

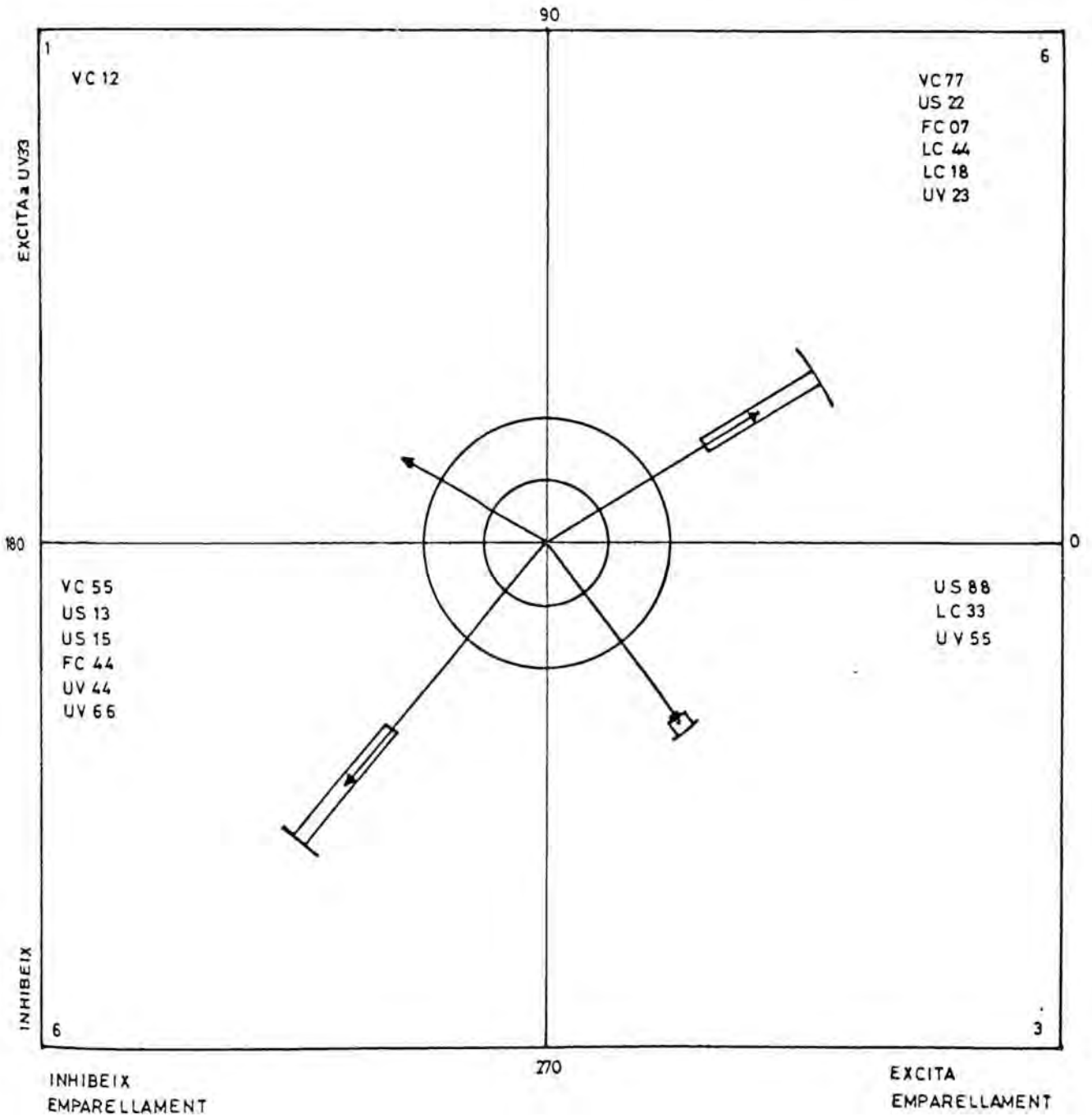

CÀLCUL DE VECTORS I ÀNGLES CORRESPONENTS A LA CONDUCTA CRITERI "UV44"
 (Situacions cooperatives)

CONDUCTA	Zsum globals		Quadrant	Valors de les coordenades polars		
	Criteri (x)	Apareo (y)	O (origen)	Radi	Arcsen θ°	Angle (θ°)
VC55	-0.08	9.28	II (-180)	9.28	90	90
VC77	-0.27	2.05	II (-180)	2.06	84.26	95.73
VC12	0.90	-4.65	IV (-360)	4.73	79.42	280.57
US22	-4.50	-6.49	III (+180)	7.89	55.28	235.28
US88	-3.34	-0.54	III (+180)	3.38	9.14	189.14
US13	2.87	-7.55	IV (-360)	8.07	69.23	290.77
US15	3.49	9.55	I (0)	10.16	69.88	69.88
CF07	-1.77	-8.86	III (+180)	9.03	78.81	258.81
CF44	2.04	13.74	I (0)	13.89	81.49	81.49
LC33	-1.88	9.85	II (-180)	10.02	79.42	100.57
LC44	1.18	1.66	I (0)	2.03	54.78	54.78
LC18	2.02	-3.16	IV -360)	3.59	61.64	298.35
UV33	-2.06	-2.97	III (+180)	3.61	55.28	235.28
UV44	2.88	2.88	I (0)	4.07	44.99	44.99
UV55	-2.94	5.21	II (-180)	5.98	60.57	119.42
UV66	-0.08	-2.50	III (+180)	2.5	90	270
Quadrant	N	\bar{X}	Radi σ	\bar{X}	Angle σ	
I	4	7.53	4.73	62.78	13.97	
II	4	6.83	3.14	101.43	11.03	
III	5	5.28	2.64	237.70	27.78	
IV	3	5.46	1.90	289.89	7.28	

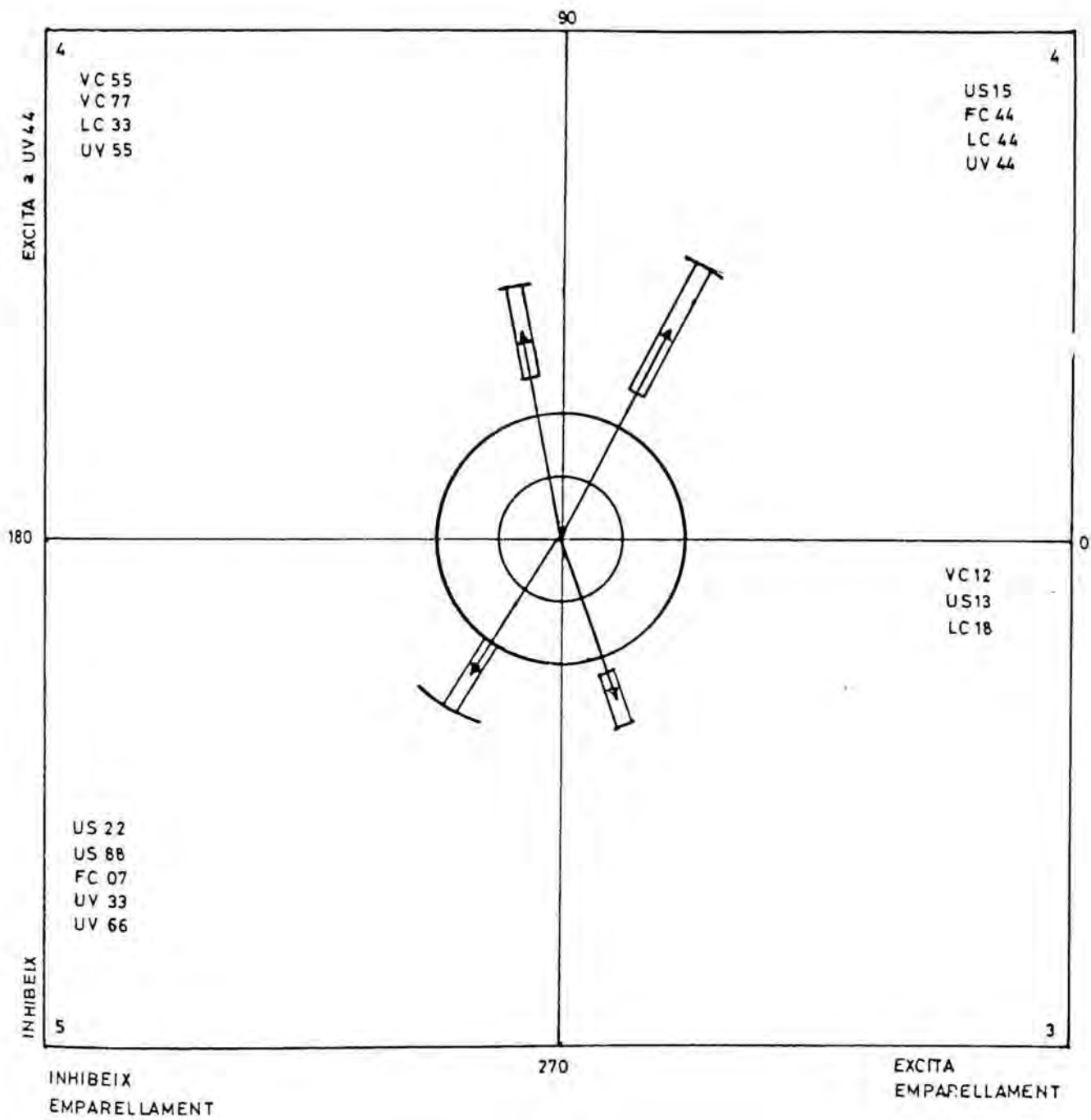

CÀLCUL DE VECTORS I ÀNGLES CORRESPONENTS A LA CONDUCTA CRITERI "UV55"
(Situacions cooperatives)

CONDUCTA	Zsum globals		Quadrant	Valors de les coordenades polars		
	Criteri (x)	Apareo (y)		O (origen)	Radi	Arcsen θ
VC55	9.57	18.55	I (0)	20.87	61.64	61.64
VC77	-5.94	-3.93	III (+180)	7.12	33.43	213.43
VC12	2.69	-3.09	IV (-360)	4.09	49.02	310.97
US22	-6.74	-2.80	III (+180)	7.29	22.58	202.58
US88	-3.01	-1.03	III (+180)	3.18	18.84	198.84
US13	-7.46	-2.55	III (+180)	7.88	18.84	198.84
US15	13.22	2.14	I (0)	13.39	9.14	9.14
CF07	-13.36	-4.33	III (+180)	14.02	17.93	197.94
CF44	13.40	6.75	I (0)	15.00	26.74	26.74
LC33	-3.88	-1.07	III (+180)	4.02	15.42	195.43
LC44	-1.52	-1.42	III (+180)	2.08	42.84	222.84
LC18	3.79	1.28	I (0)	4.00	18.66	18.66
UV33	-5.88	-2.60	III (+180)	6.42	23.82	203.83
UV44	5.21	-2.94	IV (-360)	5.98	29.40	330.59
UV55	14.85	14.85	I (0)	21.00	44.99	44.99
UV66	-4.49	-1.95	III (+180)	4.89	23.45	203.45
Quadrant	N	\bar{X}	Radi σ	\bar{X}	Angle σ	
I	5	14.85	6.22	32.23	18.84	
II	0	0	0	0	0	
III	9	6.32	3.31	204.13	8.22	
IV	2	5.03	0.94	320.78	9.81	

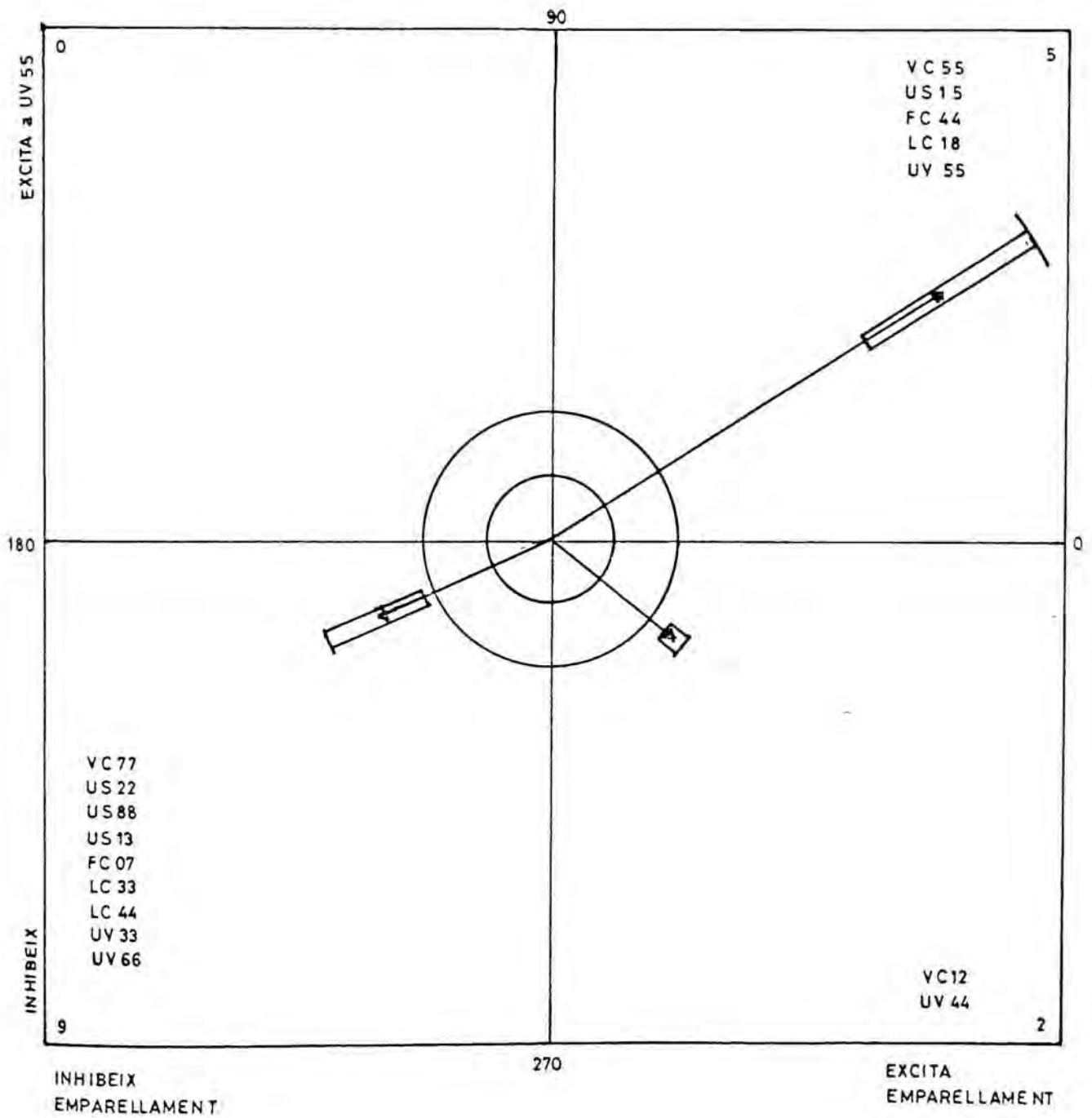

CÀLCUL DE VECTORS I ÀNGLES CORRESPONENTS A LA CONDUCTA CRITERI "UV66"
(Situacions cooperatives)

CONDUCTA	Zsum globals		Quadrant	Valors de les coordenades polars		
	Crileri (x)	Apareo (y)	O (origen)	Radi	Arcsen θ	Angle (θ)
VC55	-2.36	-4.35	III(+180)	4.94	61.64	241.64
VC77	1.76	-0.44	IV (-360)	1.81	13.53	346.47
VC12	-1.37	3.24	III (+180)	3.51	67.37	112.63
US22	-2.36	-3.46	III (+180)	4.18	55.79	235.79
US88	2.87	6.97	I (0)	7.53	67.66	67.66
US13	20.54	20.81	I (0)	29.23	45.32	45.32
US15	-12.98	-8.02	III (+180)	15.25	31.66	211.67
CF07	8.72	6.43	I (0)	10.83	36.37	36.37
CF44	-8.63	-7.82	III (+180)	11.64	42.14	222.144
LC33	-3.63	-5.00	III (+180)	6.17	54.09	234.095
LC44	-1.45	-3.42	III (+180)	3.71	67.07	247.07
LC18	4.70	3.92	I (0)	6.12	39.79	39.79
UV33	-15.39	-9.75	III (+180)	18.21	32.34	212.34
UV44	-2.50	-0.08	III (+180)	2.5	1.83	181.83
UV55	-1.95	-4.49	III (+180)	4.89	66.63	246.63
UV66	30.66	30.66	I (0)	43.35	44.99	44.99
Quadrant	N	\bar{X}	Radi σ	\bar{X}	Angle σ	
I	5	19.41	14.56	46.82	10.94	
II	1	3.51	0	112.63	0	
III	9	7.94	5.32	225.91	20.09	
IV	1	1.81	0	346.47	0	

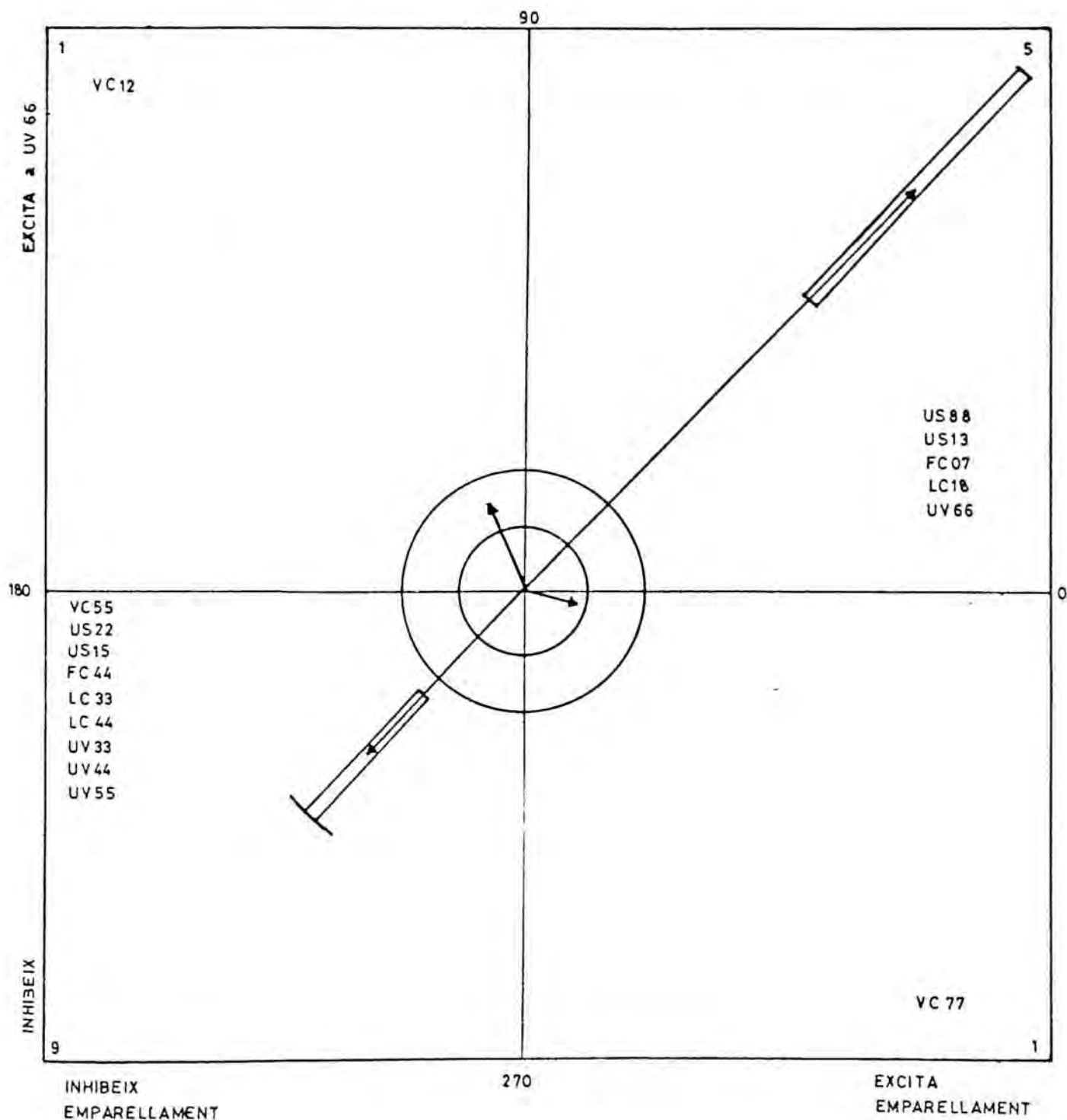

Els parells de Zsum de la matriu representades en aquestes taules es poden transformar, com hem dit, en un sistema de coordenades polars. Escollim com exemple la taula corresponent a les situacions individuals de la conducta UV33, podem constatar el quadrant en el que s'ubiquen cadascuna de les 18 conductes restants, amb la transformació que això impliqui, i els mòduls del vector radi, i l'angle () que forma el vector, a partir del càlcul del seu arcsen. Això permet, a partir del significat de cadascun dels quadrants, trobar els paràmetres de radi i angle (en el seu valor mig i desviació típica) corresponent a cadascun d'ells, la qual cosa equival o conèixer el funcionament de la conducta criteri respecte a la seva possibilitat d'excitar o inhibir a d'altres, així com la de ser excitada o inhibida per les demés.

Després de les matrius de Zsum tenim la representació gràfica relativa al càlcul de vectors i àngles corresponents a cada conducta criteri (UV33, UV44, UV55, UV66). En les gràfiques que segueixen al càlcul esmentat, en cada quadrant es reflecteix el valor mig del radi o mòdul del vector (a efectes convencionals, hem traçat dues circumferències concèntriques de radis equivalents a 2 y 4 unitats en valor Zsum, a escala), el qual a la vegada forma un àngle corresponent al valor mitjà del trobat. Els vector de mòdul significatiu (> 1.96) s'acompanyen amb la representació del valor de desviació típica mitjana en longitud i angle.

El procés de reducció de dades seguit, a més de complir l'objectiu proposat, permet que quedi oberta una línia de treball en aquest àmbit de moltes possibilitats, especialment pel que fa als estudis longitudinals. (Anguera, 1985).

7.- Conclusions.

7.- Conclusions.

Hem comprovat que amb el sistema de categories construït i aplicat a l'estudi de la interacció entre iguals en subjectes de 6-8 anys podem distingir, en major o menor grau, patrons conductuals que caracteritzen diferents situacions educatives que tenen com un factor diferencial el tipus d'organització social, ens permet estudiar la variabilitat de la conducta dels subjectes esmentats. És així com podem incrementar el coneixement al voltant de la relació educativa, els processos d'aprenentatge i, per tant, a partir d'aquest coneixement pedagògic, contribuir a la millora de l'eficàcia de l'acció pedagògica.

Es per això, que podem concloure el següent:

1) La utilització de la metodologia observacional i , especialment, la de sistemes de categories per a l'anàlisi de la interacció entre iguals, ens permet incrementar amb el rigor i la validesa necessaris el coneixement entorn a la relació educativa, objecte fonamental de l'estudi en el àmbit de la Teoria de l'Educació i de la Pedagogia en general. Aquesta conclusió ve a afegir a les clàssiques metodologies discursives i reflexives entorn al coneixement teòric de l'educació, eines pròpies de la metodologia qualitativa i quasi-experimental per tal d'incrementar la validesa d'aquest coneixement especialment en la seva vessant descriptiva i normativa.

2) El sistema de categories elaborat gaudeix de les condicions de mútua exclusivitat i exhaustivitat i, per tant, es pot considerar vàlid per a l'anàlisi de l'objecte motiu de la seva construcció.

En relació a la incidència del tipus d'organització social, les situacions individuals són molt poc significatives quant a patrons conductuals. Les situacions cooperatives es caracteritzen per major nombre de conductes d'interacció entre iguals i, com era de suposar, les col·lectives comporten un major nombre de conductes d'interacció entre diferents.

És per aquest motiu que podem concloure:

3) El tipus d'organització social és un factor diferencial pel que fa a la interacció entre iguals. Aquesta diferenciació és constatable però no és suficient per tal d'orientar l'acció pedagògica amb intenció de potenciar un tipus d'interacció o bé una altra. Per això, i en funció del que a continuació es detalla, creiem que el tipus d'organització social és una condició necessària però no suficient per diferenciar patrons conductuals en la interacció entre iguals i el període d'edats comprès entre els 6 i 8 anys.

Concretant en base a les conductes criteri analitzades trobem que:

- La unitat conductual "mirar el treball" genera en situacions individuals interacció verbal entre els subjectes, mentre que en situacions col·lectives genera conductes visuals orientades a la mestra i al voltant. Les situacions cooperatives no afavoreixen la interacció verbal tant com les individuals, però en canvi, catalitzen les conductes de parla amb si mateix així com d'expressió sensoriomotora a través de l'escriptura i l'expressió plàstica, de la mateixa manera que les individuals. El contacte físic i el desplaçament no són activats per aquesta unitat conductual en cap dels tres tipus d'organització social.

- "Mirar a la mestra" excita, en situacions individuals, conductes de parla amb un mateix, mentre que en situacions col·lectives catalitza positivament conductes de parla amb l'altre i en les cooperatives amb la mestra. La interacció entre mestre i alumne està present en les situacions individuals i les cooperatives, però no hi és tant significativament en les col·lectives.

En les situacions individuals activa la concentració visual en el treball, i en les col·lectives i cooperatives aquesta concentració no és palesa. Encara que en les cooperatives la concentració es vegi focalitzada en un altre nen i en les col·lectives no està focalitzada.

- La unitat conductual "mirar a l'altre nen" no genera, en situacions individuals, cap tipus de contacte físic, però en les col·lectives i cooperatives sí que ho fa. Així mateix, en situacions individuals no s'exciten accions que suposin l'ús d'objectes, mentre que en les col·lectives i les cooperatives passa el contrari, es fan servir objectes. En aquest cas, en tots els tipus d'organització social els subjectes

realitzen accions de manipulació fina després de mirar a l'altre nen i, en general, la interacció està més present en les situacions col·lectives i cooperatives que en les individuals.

- En les situacions individuals i cooperatives la unitat conductual "Mirar al voltant" genera la parla amb els altres i amb un mateix, mentre que en les col·lectives no genera interacció verbal. En les individuals i cooperatives el "desplaçament per l'aula" indica una concentració dels seus moviments més notable que en les col·lectives.

Quant a la riquesa de les conductes o la seva variabilitat en relació a l'organització social, constatem en les situacions individuals la variabilitat es discreta i sobretot l'obtenim a nivell d'inhibició. En les situacions col·lectives es dona una elevada variabilitat de conductes, molt diversa, tant s'exciten conductes com s'inhibeixen, aquesta variabilitat és més dirigida que en les altres i, a més, té una tendència aguditzant. En les cooperatives, que en relació a aquest factor -variabilitat- veiem que són les més potents, en general es situen en un terme mig. Però podem afirmar que les situacions col·lectives mostren més variabilitat conductual.

4) El tipus d'organització social és un factor diferencial en relació a la riquesa, variabilitat i intensitat dels patrons conductuals que han estat resultat de l'anàlisi de la interacció entre iguals.

Malgrat que hem comprovat que les situacions cooperatives es caracteritzen per major nombre de conductes de interacció entre iguals i les col·lectives comporten un major nombre de conductes d'interacció entre diferents, veiem que en funció del tipus de centre d'interés del nen en una situació o altra varia de forma peculiar. En les situacions cooperatives el centre d'interés o focus és l'objecte de l'activitat o bé el mestre, el nen en aquestes situacions es fixa en un model, observa. En les situacions col·lectives el nen busca el model, fa una activitat de descoberta, i en les individuals hi ha un interès del nen per cercar el model.

El tipus individual-col·lectiva no és tan significatiu per classificar l'activitat real del nen.

El tipus cooperativa-col·lectiva podrien formar bloc, perquè en ambdues situacions l'activitat del nen ve mediatitzada per l'actitud del mestre, és a dir, si el mestre està molt a l'abast del nen els dos tipus de situacions són diferents, però si no, no hi ha diferències.

En si mateixa l'organització social a aquesta edat no és un factor diferencial suficient quan analitzem el tipus de motivació que fa actuar al nen. En aquesta edat és l'actitud del mestre la que fa que l'organització social de les activitats a l'escola sigui un factor diferencial.

5) El tipus d'organització social és un factor diferencial en relació a la focalització de la conducta o de conductes de descoberta.

Les dades recollides ofereixen possibilitats d'anàlisi que, encara que no siguin objecte d'aquest treball, permeten l'inici d'investigacions complementàries al voltant de:

6) Aquest sistema de categories pot ser aplicat per distingir patrons conductuals en funció d'altres trets que caracteritzin les situacions educatives que puguin ser objecte d'estudi.

7) El sistema de categories de conductes moleculars elaborat permet inferir unitats funcionals de conducta a partir de formats de camp que impliquin una recollida de dades més acurada, fiable i vàlida que les directament observades a través d'observacions no sistematitzades.

8) Aquest sistema de categories permet estudiar la variabilitat de les conductes d'interacció del subjecte de 6 a 8 anys .

9) El sistema de categories de conductes moleculars elaborat permet avaluacions conductuals, entenent per avaluació conductual l'estudi longitudinal de la conducta d'un o més subjectes per tal de veure la seva modificació o evolució.

La informació obtinguda, així com les conclusions formulades, podrien ser optimitzades amb recerques que procuressin analitzar la interacció mestre-nen, les

actituds del mestre, el paper del nen en el grup i el tipus de material de treball. Per això, el sistema de categories elaborat s'hauria de transformar en un altre compost de categories molars per poder enregistrar les dades directament a l'aula, sense l'ajut de mitjans tècnics, com és el cas del video.

8.- Bibliografía consultada.

8.1.- Relativa a la 1ª part.

AA.VV. (1.983).

Teoría de la Educación I. El problema de la educación.
Murcia: Límites.

AA.VV. (1.985).

Condicionamientos sociopolíticos de la educación.
Barcelona: Ceac.

ACHENBACH, T. (1981).

Investigación en psicología del desarrollo.
México: El Manual Moderno.

ALLEN, V. (Ed.) (1976).

Children a steachers: Theory and research on tutoring.
Nueva York: Academic Press.

ALTMAN, I.; WOHLWILL, J. (Eds.) (1978).

Human behavior and environment. Vol.III: Children and the environment.
Nueva YoRk: Plenum Press.

ASHER, S.; GOTTMAN, J. (Eds.) (1981).

The development of children's frienships.
Massachussets: Cambridge University Press.

ASHER, S.R. & GOTTMAN, J.M. (Eds.) (1981).

The development of children's friendships.
New York: Cambridge University Press.

AZNAR, P. (1.984)

El concepto de optimización: su sentido en el ámbito educativo, en
Conceptos y propuestas (I). Valencia: Nau Libres.

BATESON, G. (1.972).

Pasos hacia una ecología de la mente.
Buenos Aires: Ediciones Carlos Lohlé.

BERLO, D. (1.969).

El proceso de la comunicación.
Buenos Aires: El Ateneo.

BERTALANFFY, L. von. (1.968).

General System Theory. Foundations, Development, Applications.
New York: George Braziller.

BLURTON-JONES, N. (Ed.) (1972).

Ethological studies of child behavior.
Londres: Cambridge Univesity Press.

BOZHOVICH, L.; BLAGONADIEZHINA, L. (Eds.) (1978).

Estudio de la motivación de la conducta de los niños y adolescentes.
Moscú: Progreso.

BRONFENBRENNER, U. (1979).

The ecology of human development.
Massachussets: Harvard University Press.

BROPHY, J.; GOOD, T. (1974).

Teacher-student relationship.
New York: Rinehart and Winston.

CAIRNS, R. (Ed.) (1979).
The analysis of social interactions.
New Jersey: L.E.A.

CASTILLEJO, J.L. (1.976).
Nuevas perspectivas en las Ciencias de la Educación.
Salamanca: Anaya.

CASTILLEJO, J.L. y COLOM, A.J. (1.987).
Pedagogía sistémica.
Barcelona: Ceac.

CASTILLEJO, J.L., ESCAMEZ, J. y MARIN, R. (1.981).
Teoría de la Educación.
Madrid: Anaya.

COLL, C.
"Acción, interacción y construcción del conocimiento en situaciones educativas".
Revista de Educación. 279, 9-23.

COLL, C. (1.981)
"Estructura grupal, interacción entre alumnos y aprendizaje escolar"
Infancia y Aprendizaje, 27-28, 119-138

COLL, C. (1.989).
Conocimiento psicológico y práctica educativa.
Barcelona: Barcanova.

COLOM, A.J. (1.982)
Teoría y Metateoría de la educación.
México: Trillas.

COOMBS, Ph., (1.985).
La crisis mundial de la educación. Nuevas perspectivas.
Madrid: Santillana.

CUBE, F. von., (1.981).
La Ciencia de la Educación.
Barcelona: Ceac.

DAVID, A. (1.966).
La Cybernétique et l'humain.
Paris: Gallimard.

DELVAL, J., (1.983).
Crece y pensar.
Barcelona: Laia.

DIAZ AGUADO, M. (1982).
La relación entre el tipo de educación escolar y el nivel de razonamiento moral.
Madrid: Editorial de la Universidad Complutense.

DILTHEY, W. (1.965).
Fundamentos de un sistema de Pedagogía.
Buenos Aires: Losada.

DOISE, W. (1979).
Psicología social y relaciones entre grupos.
México: Fondo Educativo Interamericano.

- DOISE, W.; DESCHAMPS, J.; MUGNY, G. (1980).**
Psicología social experimental: autonomía, diferenciación, integración.
Barcelona: Hispano-europea.
- ESCOLANO, A., (comp) (1.978).**
Epistemología y Educación.
Salamanca: Sigueme.
- ESTEVE, J.M. (ed) (1.989).**
Objetivos y contenidos de la Educación para los años noventa.
Málaga: Universidad de Málaga.
- ESTEVE, J.M., (1.979)**
Lenguaje educativo y Teoría pedagógicas.
Madrid: Anaya.
- ESTEVE, J.M., (comp) (1.984).**
Profesores en conflicto.
Madrid: Narcea.
- FLAVELL, J.; RPSS, L. (Eds.) (1981).**
Social-cognitive development.
Massachussets: Cambridge University Press.
- FROST, L. (Eds.) (1968).**
Early childhood education rediscovered.
New York: Holt.
- FURTH, H. (1980).**
The world of grown-ups. Children's conception of society.
New York: Elsevier North Holland.
- GARCIA CARRASCO, J. (1.984).**
Teoría de la Educación. Diccionario de Ciencias de la Educación.
Madrid: Anaya.
- GARCIA CARRASCO, J., (1.987).**
Apuntes de teoría de la educación.
Salamanca: Universidad de Salamanca.
- GARCIA CARRASCO, J., (.1983).**
La Ciencia de la educación. Pedagogos ¿para qué?
Madrid: Santillana.
- GERBNER, G. (1.973).**
La teoría de la comunicación y sus implicaciones en la enseñanza.
en la Educación Hoy. 7 Vol I. Barcelona.
- GIMENO, J., PEREZ, A (comp) (1.983).**
La enseñanza: su teoría y su práctica.
Madrid: Akal.
- GUILBAUD, G.T. (1.956).**
La Cybernétique.
Paris: PUF.
- HARDGREAVES, D., (1.978).**
Las relaciones interpersonales en la educación.
Madrid: Narcea.

HEINEMANN, P., (1.980).
Pedagogía de la comunicación no verbal.
Barcelona: 1980

HENNINGSSEN, J., (1.984).
Teorías y métodos en la ciencia de la educación.
Barcelona: Herder.

HETHERINGTON, E.M. (Ed.) (1983).
Handbook of child psychology. Vol.4. Socialization, personality and social development.
New York: Wiley.

HIGGINS, E.; RUBLE, D.; HARTUP, W. (Eds.) (1983).
Social cognition and social development.
Massachussets: Cambridge University Press.

HOM, H.; ROBINSON, P. (1977).
Psychological processes in early education.
New York: Academic Press.

JACKSON, D. (1986).
Life in classroom.
New York: Holt. (trad. española en Morava)

JOHNSON, D. (1972).
Psicología social de la educación.
Buenos Aires: Kapelusz.

KOHLBERG, L. (1980).
The meaning and measurement of moral judgment.
Worcester: Clark University Press.

KOHLBERG, L. (1984).
Essays in moral development. Vol II. The psychology of moral development.
San Francisco: Harper and Row.

LAMB, M.; SUOMI, S.; STEPHENSON, G. (Eds.) (1979).
Social interaction analysis: methodological issues.
London: University of Wisconsin Press.

LEWIS, M.; ROSENBLUM, L. (1975).
Friendship and peer relations.
New York: Wiley.

MARTINEZ, M. (1.987).
Proyecto docente e investigador presentado a concurso-oposición a la Cátedra de Tª de la Ed.
Barcelona: Universidad de Barcelona.

MARTINEZ, M. (1.982).
Reflexiones en torno al concepto de educación y su relación con los sistemas inteligentes ...
Educació i Cultura. 2 Palma de Mallorca.

MARTINEZ, M. (1.986).
Inteligencia y Educación.
Barcelona: PPU.

MARTINEZ, M., (1.989).
Teoría de la Educación y Filosofía de la Educación, en
AA.VV. Hombre y educación. Barcelona: PPU.

MILGRAM, S. (1980).
Obediencia a la autoridad.
Bilbao: Desclee de Bouwer.

MOORE, T.W., (1.980).
Introducción a la Teoría de la Educación.
Madrid: Alianza Universidad.

MORALES, J.F. (1.981).
La conducta social como intercambio.
Bilbao: Desclée.

MUGNY, G. y PEREZ, J.A. (1.988)
Psicología del desarrollo cognitivo.
Barcelona: Anthropos.

MUGNY, G., y DOISE, W. (1.983)
La construcción social de la inteligencia.
México: Trillas

MUSSEN, P.; CONGER, J.; KAGAN, J. (1977).
Desarrollo de la personalidad en el niño.
México: Trillas.

MUSSEN, P.H. (Ed.) (1970).
Carmichael's Manual of Child Psychologi. Vol.2.
New York: Wiley.

NIELSEN, R. (1957).
Le développement de la sociabilité chez l'enfant.
Neuchâtel: Delachaux et Niestlé.

NOHL, H. (1.968).
Teoría de la Educación.
Buenos Aires: Losada.

NOVAK, J.D., (1.982).
Teoría y práctica de la educación.
Madrid: Alianza Universidad.

PALACIOS, J.L., MARCHESI, A. y CARRETERO, (1.984).
Psicología Evolutiva. Vol 2. Desarrollo cognitivo y social del niño.
Madrid: Alianza Editorial.

PALACIOS-MARCHESI-CARRETERO. (1984).
Psicología Evolutiva. Tomo II.
Madrid: Alianza.

PATTERSON, G.; SHAW, D.; EBNER, J. (1969).
Teachers, peers and parents as agents of change in the classroom settings. Monogr. n°1.
Eugene, Or.: Dep. Educ. Espec., Universidad de Oregón.

PEREZ, A. (1.978).
Las fronteras de la educación. Epistemología y Ciencias de la Educación.
Madrid: Zero.

PERRET-CLERMONT, A.N. (1.984)
La construcción de la inteligencia en la interacción social.
Madrid: Aprendizaje Visor.

PETERS, R.S. (1.969).

El concepto de educación.

Buenos Aires: Paidós.

POSTIC, M., (1.982)

La relación educativa.

Madrid: Narcea.

PUIG, J.M. (1.986).

Teoría de la Educación. Una aproximación sistémico-cibernética.

Barcelona: PPU.

REDONDO, (1.959).

Educación y comunicación.

Madrid: CSIC.

REYMOND-RIVIER, B. (1974).

El desarrollo social del niño y del adolescente.

Barcelona: Herder.

ROBINSON, W. (Ed.) (1981).

Communication in development.

New York: Academic Press.

RODRIGUEZ DIEGUEZ, J.L. (1.982).

La optimización del acto didáctico.

en La calidad de la educación. Madrid: CSIC.

RODRIGUEZ ILLERA, J.L. (1.988).

Educación y comunicación.

Barcelona: Paidós Ibérica

RODRIGUEZ ILLERA, J.L. (1.985).

Teoría de la Educación y de la Socialización.

Barcelona: Universidad. Tesis doctoral inédita.

RUBIN, K.H. & ROSS, H.S. (1982).

Peer relations and social skills in childhood.

New York: Springer-Verlag.

RUBIN, Z. (1981).

Amistades infantiles.

Madrid: Morata.

RUSSEL, B., (1.974)

Ensayos sobre educación.

Madrid: Espasa-Calpe.

SAMUELS, S. (1977).

Enhancing self-concept in early childhood: theory and practice.

New York: Human Sciences Press.

SANVISENS, A. (1.984).

Cibernética de lo humano.

Barcelona: Oikos Tau.

SANVISENS, A. (1.968).

Memoria Docente sobre Concepto, Método, Fuentes y programa de Pedagogía General.

Oposiciones a Cátedra. Madrid.

SANVISENS, A., (dctor) (1.984).

Introducción a la Pedagogía.

Barcelona: Barcanova.

SARRAMONA, J., i FERRANDEZ, A., (1.981).

La Educación. Constantes y problemática.

Barcelona Ceac.

SCHAFFER, H. (1979).

El desarrollo de la sociabilidad en el niño.

Madrid: Pablo del Río.

SCHAFFER, H.R. (1.986)

El desarrollo de la sociabilidad.

Madrid: Aprendizaje Visor.

SCHAFFER, H.R. (1.984)

El mundo social del niño.

Madrid: Aprendizaje Visor.

SCHAFFER, H.R. (1984).

The Child's Entry in to a Social World.

London: Academic Press.

SCHEFLER, I., (1.971).

El lenguaje de la educación.

Buenos Aires: Ateneo.

SELLS, S.; ROFF, M. (1967).

Peer acceptance-rejection and personality development. Memoria final.

United States Dep. of Healt Educ. and Welfare.

SHANTZ, C. (1.982).

Social cognition. en

MUSSEN, P.H. (ed) Handbook of child Psyc

New York: Wiley.

SMITH, P.; CONNOLLY, K. (1982).

The ecology of preschool behavior.

Massachusets: Cambridge University Press.

SPECK, J., i WEHLE, G., i altres. (1.981).

Conceptos fundamentales de Pedagogía.

Barcelona: Herder.

SUCHODOLSKI, B., (1.979).

La educación humana del hombre.

Barcelona: Laia.

TRILLA, J., (1.986).

La educación informal.

Barcelona: PPU.

TRILLA, J., (1.985).

La educación fuera de la escuela.

Barcelona: Planeta.

VYGOTSKI, L.S. (1.979)

El desarrollo de los procesos psicológicos superiores.

Barcelona: Crítica.

VYGOTSKI. (monográfico) (1.984)
Infancia y Aprendizaje.
Revista Trimestral.

WILKINSON, L. (Ed.) (1982).
Communicating in the classroom.
New York: Academic Press.

WINE, J.D. & SMYE, M.D. (Eds.) (1981).
Social competence.
New York: Guilford Press.

WITTEHURST, G.J. (Ed.) (1985).
Annals of Child Development. Vol.2.
Greenwich: CT. Jai Press.

WRIGHT, D. (1974).
Psicología de la conducta moral.
Barcelona: Planeta.

YOUNISS, H. (1980).
Parents and peers in social development.
Chicago: The University of Chicago Press.

1ra. PART

ABRAMENKOVA, V. (1981).

Joint activity in the development of a humane attitude toward preschool peers.

Soviet Psychology.

38-55

ASHER, S.; MARKELL, R.; HYMEL, S. (1981).

Identifying children at risk in peer relations: A critique of the rate of interaction approach assesment.

Child Development.

521239-1245

BANDURA, A. (1977).

Self-efficacy toward a unifying theory of behavioral change.

Psychological Review.

84191-215

BAR-TAL, D.; RAVIV, A.; GOLDBERG, M. (1982).

Helping behavior among preschool children: An observational study.

Child Development

53396-402

BARRET, D.; YARROW, M. (1977).

Prosocial behavior, social inferential ability and assertiveness in children.

Child Development.

48475-481

BARUCH, G.; BARNETT, R. (1981).

Competence related behaviors of preschool girls.

Genetic Psychological Monography.

10379-103

BERND, T. (1981).

Effects of friendships on prosocial intention and behavior.

Child Development.

52636-642

BIGELOW, B. (1977).

Children's friendship expectations: A cognitive-developmental study.

Child Development.

48246-253

BLATT, M.; KOHLBERG, L. (1975).

The effects of classroom moral discussion on the development of moral judgment.

Journal of Moral Education.

2129-161

1ra. PART

BLURTON-JONES, N. (1967).

An ethological study of some aspects of social behavior of children in nursery school. En: Morris, D. (Ed.): *Primate ethology. Weidenfeld and Nicolson.*

BLURTON-JONES, N. (1972).

Categories of chil-child interaction. En: Blurton-Jones (Ed.)

BRODY, G.; STONEMAN, Z. (1981).

Selective imitation of same-age, older and younger peer models.

Child Development.

52717-720

BRONFENBRENNER, U. (1970).

Reaction to social pressure from adults versus peers among soviet day school and boarding scholl pupils in the perspective of an american sample. *Journal. Pers. Soc. Psychol.*

15179-189

BROWNLEE, J.; BAKEMAN, R. (1981).

Hiting in toddler-peer interaction.

Child Development.

521076-1079

CAMPBELL, J. (1964).

Peer relations in childhood. En: Hoffman, M.; Hoffman, L. New York: Russel Sage Foundation. *Review of Child Development Research.*

|

DIAZ-AGUADO, M. (1983).

Las expectativas en la interacción profesor-alumno.

Revista Española de Pedagogía.

162563-588

DWECK, C. (1981).

Social cognitive processes in children's friendships. En Asher y Gottman (Eds.)

FORMAN, E.; CAZDEN, C. (1984).

Perspectivas vygotskianas en la educación: el valor cognitivo de la interacción entre iguales.

Infancia y Aprendizaje.

27- 139-157

1ra. PART

FOUTS, G.; WALDNER, D.; WATSON, M. (1976).

Effects of being imitated and counterimitated on the behavior of preschool children.

Child Development.

47172-177

FURMAN, W; MASTERS, J. (1980).

Peer interactions, sociometric status and resistance to deviation in young children.

Development Psychol.

GOTTMAN, J. (1977).

Toward a definition of social isolation in children.

Child Development.

48513-517

GOTTMAN, J.; GONSO, J. (1975).

Social interaction, social competence and friendship in childre.

Child Development.

46709-718

GOTTMAN, J.; RINGLAND, J. (1981).

The analysis of dominance and biridirectionaly in social development.

Child Development.

52393-412

GRAZIANO, W.; FRENCH, D.; BROWNELL, W.; HARTUP, W. (1976).

Peer interaction in same and mixed-age triads in relation to cromological age and incetive condition.

Child Development.

47707-714

GRUSEC, J.; ABRAMOVITCH, R. (1982).

Imitation of peers and adults in a natural setting: A functional analysis.

Child Development.

53636-642

HARTUP, E.; COATES, B. (1967).

Imitation of a peer as a function of reinforcement from the peer group and rewardingness of the model.

Child Development.

671003-1016

HARTUP, W. (1964).

Friendship status ant the effectiveness of peers as reinforcing agents.

Journal Exp. Child Psychol.

1154-162

HARTUP, W. (1970).

Peer interaction and social organization. En: Mussen, P. (Ed.) New York: Wiley.

Carmichael's Manual of Child Psychology.

HARTUP, W. (1978).

Children and their friends. En: McGurk, H. (Ed.) London: Methuen.

Issues in childhood social development.

HARTUP, W.; BRADY, J.; NEWCOMB, A. (1983).

Social cognition and social interaction in childhood. En Higgins et al. (Eds).

HARTUP, W.; GLAZER, J.; CHARLESWOTH, R. (1967).

Peer reinforcement and sociometric status.

Child Development.

381017-1024

HARTUP, W. (1974).

Aggression in childhood. Developmental perspectives.

American Psychologist.

336-341

JOHNSON, D. (1981).

Student-student interaction: The neglected variable in education.

Educational Researcher.

105-10

JOHNSON, D.; AHLGREN, A. (1976).

Relationship between student attitude about cooperation and competition and attitudes toward schooling.

Journal Educ. Psychol.

6892-102

JOHNSON, D.; JOHNSON, R. (1979).

Conflict in the classroom: controversy and learning.

Review Educational Research.

4951-70

JOHNSON, D.; JOHNSON, R. (Eds.) (1978).

Social interdependence in the classroom: cooperation, competition and individualism.

Journal Res. Develop. Educ.

12

1ra. PART

JOHNSON, D.; MARUYAMA, G.; JOHNSON, R.; NELSON, D.; SKON, L. (1981).

Effects of cooperative, competitive and individualistic goal structures on achievement: a meta-analysis.

Psychological Bulletin.

8947-62

JOHNSTON, A.; DeLUCA, D.; MURTANGH, K.; DIENER, E. (1977).

Validation of a laboratory play measure of child aggression.

Child Development.

48324-327

KAMII, C. (1982).

La autonomía como objetivo de la educación: implicaciones de la teoría de Piaget.

Infancia y Aprendizaje.

183-32

KANE, J.; LAWER (1978).

Methods of peer assesment.

Psychol. Bull;

85555-586

KOHLBERG, L.; GILLIGAN, C. (1971).

The adolescents as a philosopher: the discovery of the self in a post-conventional world.

Daedalus.

LADD, G.; ODDEN, S. (1979).

The relationship between peer-acceptance and children's ideas about helpfulness.

Child Development.

50402-408

LAMB, M.; ROOPHARINE, J. (1979).

Peer influences on sex-role development in preschoolers.

Child Development.

501219-1222

LEITER, M. (1977).

A study of reciprocity in preschool play groups.

Child Development.

481288-1295

LIEBERMAN, A. (1977).

Prescholer's competence with a peer: relations with attachment and peer experience.

Child Development.

481277-1287

LIPPIT, A.; WHITE, R. (1943).

The social climate of children's groups. En: Barker, J. et al. (Eds.) New York: McGraw Hill.

Child behavior and development.

LIPPIT, R. (1941).

Popularity among preschool children.

Child Development.

1 2 3 0 5 - 3 2 2

LOMOV, B. (1978).

Psychological processes and communication.

Soviet Psychology.

3 - 2 2

MARSHALL, H.; McCANDLESS, R. (1957).

Relationships between dependence on adults and social acceptance by peers.

Child Development.

2 8 1 4 9 - 1 5 9

MUGNY, G.; DOISE, W. (1978).

Sociocognitive conflict and structuration of individual and collective performance.

European Journal of Social Psychology.

8 1 8 1 - 1 9 2

MUMA, J. (1965).

Peer evaluation and academic performance.

Personn. Guid. Journal.

4 4 4 0 5 - 4 0 9

NUCCI, L.; TURIEL, E. (1978).

Social interactions and the development of social concepts in preschool children.

Child Development.

4 9 4 0 0 - 4 0 7

PERRET-CLERMONT, A.; SCHUBAUER-LEONI, M. (1981).

Conflict and cooperation as opportunities for learning. En: Robinson (Ed.).

PUTTALLAZ, M.; GOTTMAN, J. (1981).

An interactional model of children's entry into peer group.

Child Development.

5 2 9 8 6 - 9 9 4

1ra. PART

PUTTALLAZ, M.; GOTTMAN, M. (1981).

Social skills and group acceptance. En: Asher & Gottman (Eds.).

RUBTSOV, V. (1981).

The role of cooperation in the development of intelligence.

Soviet Psychology.

41-62

SLAVIN, R. (1980).

Cooperative learning.

Review Educational Research.

502315-342

SNOW, M.; JACKLIN, C.; MACCOBY, E. (1981).

Birth order differences in peer socialibility at thirty-three months.

Child Development.

52589-595

SOLOMAN, R.; WAHEL, R. (1973).

Peer reinforcement control of classroom problem behavior.

Journal App. Beha. Anal.

649-56

SROUFE, A. (1981).

Attachment, positive affect and competence in the peer group.

Child Development.

50821-829

TURIEL, E. (1983).

Domains and categories in social-cognitive development. En: Overton (Ed.) New Jersey: LEA.

The relationship between social and cognitive development.

TURIEL, E. (1983).

Interaction and development in social cognition. En: Higgins et al. (Eds.).

ULLAMN, C. (1957).

Teachers, peers and tests as predictors of adjustment.

Journal Educ. Psychol.

48257-267

1ra. PART

WAHLER, R. (1967).

Child-child interactions in five field settings: some experimental analysis.

Journal Exp. Child Psychol.

5 278-293

8.2.- Relativa a la 2ª part.

2ª PART

ADELMAN, C. (1981).

Uttering, muttering, collecting, using and reporting talk for social educational research.
London: Frank McIntyre.

ALBERDI, J. (1969).

Metodología de la investigación y muestreo.
Madrid: Euroamérica.

AMIDON, E.J., & HOUGH, J.B. (1967).

Interaction analysis: Theory, research and application.
Reading Mass: Addison-Wesley.

ANGUERA, M.T.

Conducta animal y representaciones mentales.
Barcelona: P.P.U.

ANGUERA, M.T. (1982).

Metodología de la observación en ciencias humanas.
Madrid: Cátedra.

ARNAU, J. (1978).

Psicología Experimental. Un enfoque metodológico.
México: Trillas.

BAKEMAN, R., & GOTTMAN, J.M. (1986).

Observing Interaction to Sequential Analysis.
New York: Cambridge University Press.

BARKER, R.G. (1963).

The stream of behavior,
New York: Appleton Century Crofts.

BARKER, R.G. (1955).

Midwest and its children.
New York: Harper & Row.

BARKER, R.G. (1968).

Ecological psychology: Concepts and methods for studying the environment
California: Univ. Stanford.

BARKER, R.G. & WRIGHT, H.F. (1951)

One boy's day.
New York: Harper.

BARNES, D. & TODD, F. (1977).

Communication and learning in small groups.
London: Routledge & Paul Kegan.

BARR, R. & DREEBAN, R. (1983).

How schools work.
Chicago: University Press.

BARTOLOME, M.

La investigación-acción.
(en prensa)

BEEGLE, C.W. and BRANT, R.M. (Eds.) (1973).

Observational methods in the classroom.
Washington DC: Assoc. for Superv and Curric

BERKOWITZ, L. (1.984).

Advances in Experimental Social Psychology.
New York: Academic Press.

BERLINER, D. (Ed) (1980).

Review of research in education. Vol 8.
Washington DC: American Ed. Res. Ass.

BLANK, M. (1973).

Teaching learning in the preeschool,
Columbus OH, Charles E. Merrill,

BLISS, J.M., & OGBORN, J. (1983)

Qualitative data nalysis for eduacational research.
London: Croom Helm.

BLURTON-JONES, N., (Eds). (1972).

Ethological studies of child behavior
London: Cambridge Univ. press.

BORGER, R. (1974)

La explicación en Ciencias de la Conducta.
Madrid: Alianza.

BORMAN, K (ed). (1982).

The social life of children in a changing society.
Hillsdale NJ: Lawrence Erlbaum Ass.

BOSSERT, S. (1975).

Tasks and social relationship in classrooms.,
Cambridge, University Press,

BOYER, E.G., SIMON, A. & KARAFIN, G.R. (dirs). (1973).

Measures of Maturation: An Anthology of Early Childhood Observation Instruments.
Filadelfia: Research for Better Schools.

BRANT, R.M. (1972).

Studing behavior in natural settings.
New York: Holt, Rinehart & Winston.

BROWN, C.W. (1969)

El método científico en Psicología.
Buenos Aires: Paidós.

BURGESS, R.G. (1986).

Key Variables in Social Ivestigation.
London: Routledge and Kegan Paul.

BURGESS, R.G. (Ed). (1984).

The Research Process in Educational Settings: Ten Case Studies.
Lewes: Falmer Press.

CAGE, N.L. (1.973)

Handbook of Reseach on Teaching (2nd. ed.)
Chicago: Rand McNally.

CAIRNS, R.B. (1979)

The Analysis of Social Interactions.
Hillsdale, n.j.: Lawrence Erlbaum Assoc.

2ª PART

- CHANAN, G. & DELAMONT, S. (Eds). (1975).**
Frontiers of Classroom Research.
Windsor: NFER.
- COCHRAN, W.G. (1.977).**
Sampling techniques.
New York: Wiley & Sons.
- COHEN, L. (1976).**
Educational Research in Classroom and Schools.
London: Harper & Row.
- COHEN, L. & MANION, L. (1980).**
Research Methods in Education.
London: Croom Helm.
- COLL, C. (Coord.) (1.985).**
Métodos de observación y análisis de los procesos educativos.
Barcelona: ICE
- CONNER, R. (1981)**
Methodological advances in Evaluation Research.
London: Sage.
- COOK, T.D., & REICHART, H. (1979)**
Qualitative vs. quantitative methods in Evaluation Research.
London: Sage.
- COOPER, C., AYRES-LOPEZ, S & MARQUIS, A. (1981).**
Children's discourse cooperative and diadic interaction.
Washington DC: National Inst. of Ed.
- CORSARO, W. (1985).**
Friendship and peer culture in the early years.
Norwood NJ, Ablex,
- CROLL, P. & MOSES, D. (1.985).**
One in Five: The Assessment and Incidence of Special Educational Needs.
London: Routledge and Kegan Paul.
- CROLL, P., & MOSES, D. (1985).**
One in Five: The Assessment and Incidence of Special Educational Needs.
London: Routledge & Kegan Paul.
- DELAMONT, S. (1983).**
Interaction in the Classroom.
London: Methuen.
- DELCLAUX, I., & SEOANE, J.**
Psicología cognitiva y procesamiento de la información.
Madrid: Pirámide.
- DORSCH, F. (1.976).**
Diccionario de Psicología.
Barcelona: Herder.
- DUCKETT, W., (Ed). (1983).**
Observation and the evaluation of teaching.
Bloomington IN: Phi Delta Kappa.

2^a PART

DUNCAN, S., & FISKE, D. (1977).
Face to face interaction. Research, methods and theory.
Hillsdale, NJ: Lawrence Erlbaum.

DUNKIN, M., & BIDDLE, B. (1974).
The study of teaching,
New York: Holt, Rinehart & Winston.

EDWARDS, A., & FURLONG, V. (1978).
The language of teaching: Meaning in classroom interaction.
London: Heinemann.

FASSNACHT, G. (1982).
Theory and practice of observing behavior.
London: Academic Press.

FERNANDEZ BALLESTEROS, J.A.
Evaluación conductual: Metodología y aplicaciones.
Madrid: Pirámide.

FERNANDEZ BALLESTEROS, R. (1980).
Psicodiagnóstico. Concepto y metodología.
Madrid: Cincel.

FERNANDEZ BALLESTEROS, R. (1981).
Nuevas aportaciones en evaluación conductual.
Valencia: Alfaplus.

FLANDERS, N. (1970).
Analyzing Teaching Behaviour.
New York: Addison-Wesley.

GAGE, N.L., (Ed). (1963).
Handbook of research on teaching.
Chicago: Rand Mc Nally.

GALLAGHER, J. (Ed). (1970).
Classroom Observation.
Chicago: Rand-McNally.

GALTON, M., & SIMON, B. (Eds). (1980).
Progress and Performance in the Primary Classroom.
London: Routledge & Kegan Paul.

GALTON, M., & WILLCOCKS, J. (Eds). (1983).
Moving from the Primary Classroom.
London: Routledge & Kegan Paul.

GALTON, M., SIMON, D. & CROLL, P. (1980).
Inside the Primary Classroom.
London: Routledge and Kegan Paul.

GALTUNG, J. (1970).
Theory and Methods in Social Research.
London: Allen and Unwin.

GORDON, E., (Ed). (1983).
Review of research in education. Vol 10
Washington DC, American Ed. Research

2^a PART

- GOTTMAN, J.M.** (1.979)
Marital Interaction: Experimental Investigations.
New York: Academic Press.
- GREEN, J., & WALLAT, C., (eds).** (1.981).
Ethnography and language in educational settings.
Norwood, NJ: Ablex.
- GUBA, E.G.** (1.978).
Toward a Methodology of Naturalistic Inquiry in Educational Evaluation.
London: Routledge and Kegan Paul.
- GUMP, P.** (1967).
The classroom behavior setting: Its nature and relation to student behavior.
Kansas: University.
- HAMMERSLEY, M., & ATKINSON, P.** (1983).
Ethnography: Principles in Practice.
London: Tavistock.
- HILSUM, S & CANE B.** (1.971).
The Teacher's Day.
Windsor: NFER.
- HUTT, S.J., & HUTT, C.H.** (1970).
Direct observation and measurement of behavior.
Springfield: Charles C. Thomas.
- JACKSON, P.W.** (1968).
Life in classrooms.
New York: Holt, Rinehart & Winston.
- KIDDER, L. et al.** (1981).
Research Methods in Social Relations.
New York: Holt, Rinehart and Winston.
- LAMB, M.B., SUOMI, S.J., & STEPHENSON, G.R. (Eds.)** (1979)
Social Interaction Analysis. Methodological Issues.
Madison, Wisconsin: The University of Wisconsin Press.
- LEHNER, P.N.** (1.979)
Handbook of ethological methods.
New York: Garland Press.
- LUNDGREN, U.** (1977).
Model analysis of pedagogical processes.
Stokholm: Dept. Educational Research.
- MANHEIM, H.L.** (1982)
Investigación sociológica. Filosofía y métodos.
Barcelona: CEAC.
- MARSHALL, H.H., & WEINSTEIN, R.** (1982).
Classroom Dimensions Observation System: Manual
Berkeley: Univ. of California.
- MC ALEESE, R. & HAMILTON, D. (Eds).** (1978).
Understanding Classroom Life.
Windsor: NFER.

2ª PART

McCALL, G., & SIMMONS, J. (1969).

Issues participant observation.

Reading MA: Addison Wesley.

MILLMAN, J., (ed). (1981).

Handbook of teacher evaluation.

Beverly Hills: Sage Publications.

MOOS, R. (1976).

The human context: Environmental determinants of behavior.

New York: John Wiley.

MUCHIELLI, R. (1.974)

L'observation psychologique et psychosociologique.

Paris: Librairies Techniques, Entreprise Moderne ESF.

MUSSEN, P. (1960).

Handbook of research methods in child development.

New York: John Wiley.

NAROLL, R. & COHEN, R. (Eds) (1.973).

Handbook of Methods in Cultural Anthropology.

New York: Columbia University.

OBER, R., BENTLEY, E., & MILLER, E. (1971).

Systematic Observation of teaching: An interaction analysis-instruc.

Englewood Cliffs NJ, Prentice-Hall,

OLSON, W.C. (1.929).

The measurement of nervous habits in normal children.

Minneapolis: University of Minnesota Press.

PREISSELE, GOETZ, J., & LECOMPTE, M. (1.984).

Ethnography and qualitative design in Educational Research.

London: Academic Press, Inc.

QUERA, V. (1.986).

Micro-análisis de la conducta interactiva: Una aplicación a la interacción materno-filial ei

Tesis Doctoral inédita. Barcelona: Universidad de Barcelona.

QUERA, V. (1.987).

Metodología Observacional.

Manuscrito inédito. Barcelona: Universidad de Barcelona.

ROGERS, E (1.979)

Relacional Communication Control Coding Manual.

Philadelphia: International Communication Association Convention.

RUESCH, J. & BATESON, G. (1.951).

Communication: The Social Matrix of Psychiatry.

New York: John Wiley & Sons.

SACKETT, G.P. (1.978)

Observing behavior. Vol II. Data collection and analysis methods.

Baltimore: University Park Press.

SAINZ, J. (1.985).

Uso y competencia categorial.

Tesis Doctoral inédita. Madrid: Universidad Complutense.

- SCHAFFER, H.R. (Ed.) (1977)**
Studies in Mother-Infant Interaction.
London: Academic Press.
- SCHATZMAN, L., & STRAUSS, A. (1973).**
Field research: Strategies for a natural sociology.
Englewood Cliffs NJ: Prentice-Hall.
- SCHERER, K.R. & EKMAN, P. (Eds.). (1.982).**
Handbook of methods in nonverbal behavior research.
Cambridge: Cambridge University Press.
- SELLTIZ, C., JAHODA, M., DEUTSCH, M., & COOK, S.W. (1.965).**
Métodos de investigación en las relaciones sociales.
Madrid: Rialp.
- SILBERMAN, C. (1970).**
Crisis in the classroom.
New York: Random House.
- SIMON, A., & BOYER, E.G. (Eds). Supplementary (1970).**
Mirrors for behavior: An anthology of classroom observation instruments.
Philadelphia: Research for Better Schools.
- SIMON, A., & BOYER, E.G. (Eds). Vols. 1-6. (1967).**
Mirrors for behaviour: An anthology of classroom observation instruments.
Philadelphia: Research for Better Schools, V.1-6
- SIMON, A., & BOYER, E.G. (Eds). Vols. 7-14. (1970).**
Mirrors for behavior: An anthology of classroom observation instruments.
Philadelphia: Research for Better Schools.
- SIMON, B., & WILLCOCKS, J. (Eds). (1981).**
Research and Practice in the Primary School.
London: Routledge & Kegan Paul.
- SMITH, E.E. & MEDIN, D.L. (1.981).**
Categories and concepts.
Cambridge: Harvard University Press.
- SPODEK, B., (Ed). (1983).**
Handbook of research in early childhood education.
New York: Free Press.
- SPRADLEY, J. (1980).**
Participant observation.
New York: Holt Rinehart & Winston.
- STALLINGS, J. (1977).**
Learning to look. A handbook on classroom observation and teaching models
Belmont CA: Wadsworth.
- STALLINGS, J.A. (1973).**
Follow Through program classroom observation evaluation 1971-72.
California: Stanford Research Institute.
- STUBBS, M., & DELAMONT, S. (1976).**
Explorations in Classrooms Observations.
Chichester: Wiley.

2ª PART

TRIVERS, R.M.V. (Ed). (1973).

Second handbook of research on teaching,
Chicago: Rand Mc Nally.

VON BERTALANFFY, L. (1.976).

Teoría general de sistemas.
México: Fondo de Cultura Económica.

WATZLAWICK, P. et al. (1.981)

Teoría de la comunicación humana.
Barcelona: Herder.

WATZLAWICK, P., BEAVIN, J. y JACKSON, D.D. (1.967).

Pragmatics of Human Communication.
New York: W.W. Norton & Co.

WEINBERG, R. & WOODS, F. (1975).

Observation of pupils and teachers in mainstream and special ed..
Minneapolis: Univ. Minnesota Press.

WILLEMS, E., & RAUSH, H., (Eds). (1969).

Naturalistic viewpoints in psychological reseacrh.
New York: Holt Rinehart & Winston.

WITTROCK, M.C. (Ed.) (1.986).

Handbook of research on teaching. A project of the American Educational Research Ass.
New York: Mc Millan.

WOLMAN, B.B.

Manual de Psicología. (Vol.1)
Barcelona: Martínez Roca.

YUREN, M.T. (1.979).

Leyes, teorías y modelos.
México: Trillas.

2ª PART

AITKEN, M., BENNETT, S. and HESKETH, J. (1981).
Teaching styles and pupil progress: A reanalysis.

British Journal of Educational Psychology.

ALLISON, P.D., & LIKER, J.K. (1982).

Analyzing sequential categorical data on dyadic interaction: A comment on Gottman.

Psychological Bulletin

91, (2)393-403

ALTMAN, J. (1974).

Observational sampling of behaviour; Sampling methods.

Behaviour.

49,227-267

ANDERSON, M. (1974).

Temporal graphical analysis of behaviour sequences.

Behaviour.

51, (1-2)38-48

ANGUERA, M.T. (1981)

Identificación de patrones de conducta en el retrasado mental.

Primeras Jornadas Nacionales de Retraso Mental.

Huelva: Diciembre

ANGUERA, M.T. (1981).

Análisis secuencial en la evaluación del comportamiento: Comentarios en torno a una nueva metodología.

Reunión Internacional de Psicología Científica.

Alicante: Febrero

ANGUERA, M.T. (1981).

La observación (II): Situaciones naturales y de laboratorio. En R.Fernández Ballesteros y J.A.I. Carroble (eds.).

Evaluación conductual. Metodología y aplicaciones.

Madrid: Pirámide 334-363

ANGUERA, M.T. (1981).

Análisis del cambio cíclico y su racionalización a partir de una recogida de datos cualitativa.

I Jornada d'Actualització Psicològica.

Barcelona: Mayo

ANGUERA, M.T. (1982).

Posibilidades de la metodología secuencial en el análisis de intervención familiar.

Reunión Nacional sobre Intervención Psicológica.

Murcia: Marzo-abril

2ª PART

AITKEN, M., BENNETT, S. and HESKETH, J. (1981).

Teaching styles and pupil progress: A reanalysis.

British Journal of Educational Psychology.

ALLISON, P.D., & LIKER, J.K. (1982).

Analyzing sequential categorical data on dyadic interaction: A comment on Gottman.

Psychological Bulletin

91, (2)393-403

ALTMAN, J. (1974).

Observational sampling of behaviour; Sampling methods.

Behaviour.

49,227-267

ANDERSON, M. (1974).

Temporal graphical analysis of behaviour sequences.

Behaviour.

51, (1-2)38-48

ANGUERA, M.T. (1981)

Identificación de patrones de conducta en el retrasado mental.

Primeras Jornadas Nacionales de Retraso Mental.

Huelva:Diciembre

ANGUERA, M.T. (1981).

Análisis secuencial en la evaluación del comportamiento: Comentarios en torno a una nueva metodología.

Reunión Internacional de Psicología Científica.

Alicante:Febrero.

ANGUERA, M.T. (1981).

La observación (II): Situaciones naturales y de laboratorio. En R.FERNANDES BALLESTERO y J.A.I. CARROBLES (Eds.).

Evaluación conductual. Metodología y aplicaciones.

Madrid: Pirámide. 334-363.

ANGUERA, M.T. (1981).

Análisis del cambio cíclico y su racionalización a partir de una recogida de datos cualitativa.

I Jornada d'Actualització Psicològica.

Barcelona:Mayo.

ANGUERA, M.T. (1982).

Posibilidades de la metodología secuencial en el análisis de intervención familiar.

Reunión Nacional sobre Intervención Psicológica.

Murcia:Marzo-abril.

ANGUERA, M.T. (1985).

Posibilidades de la metodología cualitativa vs. cuantitativa.

Revista de Investigación Educativa.

3-6, 127-145

ANGUERA, M.T. y BLANCO, A. (1982).

Adaptación del procedimiento de análisis de la secuencialidad interactiva de Sackett.

VII Congreso Nacional de Psicología.

Santiago de Compostela: Abril.

ARNAU, J.; ANGUERA, M.T. y BLANCO, A. (1981).

Observación de la conducta interactiva: Análisis de datos.

Memoria correspondiente al I Informe del Proyecto de Investigación (Com. Ases. Inv. Científ.

Barcelona: Abril.

ARRINGTON, R.E. (1939).

Time-sampling studies of child behavior.

Psychological Monographs.

51.

ARRINGTON, R.E. (1943).

Time-sampling in studies of social behavior: A critical review of techniques and results with research suggestions.

Psychological Bulletin.

40, 81-124.

ATKINSON, P. y DELAMONT, S. (1980).

Effective teaching: a comment.

British Journal of Teacher Education.

6, 3.

BAKEMAN, R. & BROWN, J.V. (1977).

Behavioral dialogues: An approach to the assessment of mother-infant interaction.

Child Development.

48, 195-203.

BAKEMAN, R., & ADAMSON, L.B. (1987).

Lags and logs: Statistical approaches to interaction." Manuscrito no publicado. Próxima publicación en M.H. Bornstein & J. Bruner (Eds.)

Interaction in Human Development.

Hillsdale, N.J.: Lawrence Erlbaum Assoc.

BELL, R.Q. (1974).

Contributions of human infants to caregiving and social interaction. In

M. LEWIS & L.A. ROSENBLUM (Eds.) *The effect of the infant on its caregiver.*

New York: Wiley.

BELLOCH, A. y MIRA, J.A. (1.984).

Categorización de personas: Rasgos, tipos, prototipos y ... personas?

Boletín de Psicología.

4,7-31.

BENNETT, N., O'HARE, E. y LEE, J. (1983).

Mixed age classes in primary schools.

British Educational Research Journal.

9,1.

BLANCO, A. (1.982).

Metodología de la observación en la Educación Especial.

Butlletí.

10,23-29.

BOBBITT, R.; GOUREVITCH, V.; MILLER, L. & JENSEN, G. (1969)

Dynamics of social interaction behavior: A computerized procedure for analyzing trends, patterns and sequences.

Psychological Bulletin.

71,110-112.

BOYDELL, D. (1975).

Pupil behaviour in junior classrooms.

British Journal of Educational Psychology.

45.

BROWN, G. (1.975).

Micro-teaching: Research and developments. In G. CHANAN. & DELAMONT, S. (Eds).

Frontiers of Classroom Research.

Windsor: NFER.

BRYMAN, A. (1984).

The debate about quantitative and qualitative research: A question of method or epistemology?

British Journal of Sociology.

35,1

BUDESCU, D.V. (1984).

Tests of lagged dominance in sequential dyadic interaction.

Psychological Bulletin.

96,402-414

CAIRNS, R.B. (1979).

Social interactional methods: An introduction. In R.B. CAIRNS (Ed.).

The analysis of social interactions.

Hillsdale, N.J.: LEA 195-206.

2ª PART

COLL, C. (1.981).

Algunos problemas planteados por la metodología observacional: Niveles de descripción e instrumentos de validación.

Anuario de Psicología.

24,(1), 11-131.

CONDON, W.J. & OGSTON, W.D. (1.967).

A segmentation of behavior.

Journal of Psychiatric Research.

5,221-235.

CROLL, P. (1.981).

Social class, pupil achievement and classroom interaction. In B. SIMON & J. WILLCOCKS (Eds).

Research and practice in the primary classroom.

London: Routledge and Kegan Paul.

CROLL, P. (1984).

Statistical inference in educational research.

Educational research.

26,3.

CROMWELL, R.E. & PETERSON, G.W. (1.981).

Multisystem-multimethod assessment: A framework. In E.E. FILSINGER & R.A. LEWIS (Eds).

Assessing Marriage.

Beverly Hills: Sage. 38-54.

DELAMONT, S. & HAMILTON, D. (1.984).

Revisiting classroom research: A continuing cautionary tale. In S. DELAMONT (Ed).

Readings on Interaction in the Classroom.

London: Methuen.

DICKMAN, H.R. (1.963).

The perception of behavioral units. In R. BARKER (Ed.)

The stream of behavior.

New York: Appleton-Century- Crofts. 23-41.

DOUGLAS, J.M., & TWEED, R.L. (1979).

Analyzing the patterning of a sequence of behavioural events.

Animal Behaviour.

27,1236-1252.

DUMAS, J.E (1986).

Controlling for autocorrelation in social interaction analysis.

Psychological Bulletin.

100,(1), 125-127.

EMMER, E., & PECK, R. (1973)

Dimensions of Classroom Behaviour.

Journal of Educational Psychology.

64, 223-240.

ESCUADERO, V. y GUTIERREZ, E. (1987).

Una perspectiva secuencial de la dimensión relacional de la comunicación.

Departamento de Psicología Clínica y Psicobiología

Universidad de Santiago.

EVERTSON, C.M. & GREEN, J.L. (1.986).

Observation as inquiry and method. In M.C. WITTROCK (Ed.)

Handbook of research on teaching. A project of the American Educational Research Association

New York:MacMillan, 162-213.

FARAONE, S.V., & DORFMAN, DD, (1987)

Lag sequential analysis: Robust statistical methods.

Psychological Bulletin.

101,(2), 312-323

FARKAS, G.M. & THARP, R.G. (1980).

Observation procedure, observer gender and behavior valence as determinants of sampling error in a behavior assessment analogue.

Journal of Applied Behavior Analysis.

13,529-536.

FREDERICKSEN, N. (1.972).

Toward a taxonomy of situations.

American Psychologist,

27,114-123.

FRICK, T. y SEMMEL, M. (1978).

Observer agreement and reliabilities of classroom observational measures.

Review of Educational Research.

48,157-184

FURLONG, V. y EDWARDS, A. (1977).

Language in classroom interaction:Theory and data.

Educational Research.

21,

GOODENOUGH, F.L. (1930).

Inter-relationship in the behavior of young children.

Child Development.

1,29-47.

2ª PART

GOTTMAN, J.M. & BAKEMAN, R. (1979).

The sequential analysis of observational data. En M.E. LAMB; S.J. SUOMI & STEPHENSON (Eds.)

Social interaction analysis, Methodological issues.

Madison: Univ. Wisconsin | 185-206.

GUILIERON, Ch. (1.980).

El psicopedagogo, como observador: por qué y cómo.

Infancia y Aprendizaje.

9,7-21.

HALL, A.D. & FAGEN, R.E. (1.968).

Definition of system. In W. BUCKLEY (Ed.).

Modern systems research for the behavioral scientist.

Chicago:Aldine. 81-92.

HAMILTON, D. & DELAMONT, S. (1.974).

Classroom research: A cautionary tale?

Research in Education.

11,

HAWKINS, R.P. (1.982).

Developing a behavioral code. In D.P. HARTMANN (Ed).

Using observers to study behavior.

San Francisco:Jossey-Bass.51-65.

HERBERT, J., & ATTRIDGE, C.(1975).

A guide for developers and..

American Educational Reseach Journal,

(1)1-2012,1-20.

KAYE, K. (1982)

The moral philosophy of microanalysis.En T. Field & A. Fogel (Eds.)

Emotion and Early Interaction,

Hillsdale, N.J.:Lawrence Erlbaum Assoc.237-251.

KAYE,K.,& FOGEL, A. (1.980).

The temporal structure of face-to-face communication betweeb mothers and infants.

Development Psychology,

16,454-464.

KOEHLER, V. (1978).

Classroom process research: present and future.

Journal of Classroom interaction.

13,3-10.

LIGHT, R.J.(1971).

Measures of response agreement for qualitative...

Psychological Bulletin.

76,365-377.

LINGLE, J.H., ALTON, M.W. Y MEDIN, D.L. (1.984).

Of cabbages and kings: Assessing the extendibility of natural object concept. Models to social things. In R.S WYER & T.K. SRULL (Eds.).

Handbook of social cognition.

Hillsdale, N.J.:Lawrence Erlbaum Ass.

MARTIN, J.A., MACCOBY, E.E., BARAN, K.W., & JACKLIN, C.N. (1981).

Sequential analysis of mother-child interaction at 18 months: A comparison of microanalytic methods.

Developmental Psychology.

17,(2), 146-157.

MARTON, P., MINDE, K., & OGILVIE, J. (1981).

Mother-infant interactions in the premature nursery. A sequential analysis. En S.L. FRIEDMAN & M. SIGMAN (Eds.).

Preterm Birth and Psychological Development.

London:Academic Press 179-205.

McCUTCHEON, G. (1981).

On the interpretation of classroom observation.

Educational Researcher.

10,(5), 5-10.

McGAW, B., WARDROP, J., & BUNDA, M. (1972).

Classroom observation..

American Educational Research Journal.

9,13-27.

MCINTYRE, D. & MACLEOD, G. (1.978).

The characteristics and uses of systematic observation. In R. McALEESE & D. HAMILTON, (Eds).

Understanding Classroom Life.

Windsor:NFER.

MEAZZINI, P. & RICCI, C. (1.986).

Molar vs. molecular units of behavior. In. T. THOMPSON & ZEILER, M.D. (Eds.).

Analysis and integration of behavioral units.

Hillsdale:Lawrence Erlbaum Ass. 19-43.

MERVIS, C.B. & PANI, J.R. (1.980).

Acquisition of basic object categories.

Cognitive Psychology,

12,496-522.

2ª PART

MERVIS, C.B. & ROSCH, F. (1.981).

Categorization of natural objects.

Annual Review of Psychology.

32,89-115.

OJA, S.H.(1984).

Role issues in practical collaborative research on change in schools. Paper presented at the Annual Meeting of the American Educational Research Association.

New Orleans, Ap.

OJA, S.H., & PINE, G. (1983).

A two years study of Teachers Stages of Development in relation to Collaborative Action Research in Schools. Final Report, National Institute of Education.

Washington

PATTERSON, G.R. (1974).

A basis for identifying stimuli which control behaviors in natural settings.

Child Development.

45,900-911.

PATTERSON, G.R. (1977).

Naturalistic observation in clinical assessment.

Journal of Abnormal Child Psychology.

5,309-322.

PINE, G. (1981).

Collaborative Action Research: The Integration of Research and Service. Paper presented at the Annual Meeting of the American Association of Colleges for Teachers Education.

Detroit

POWELL, J.; MARTINDALE, A. & KULP, S. (1975).

An evaluation of timesample measures of behavior.

Journal of Applied Behavior Analysis.

8,463-469.

QUERA, V. (1.988).

Conducta concurrente en situaciones interactivas: Categorización multidimensional e indicadores. En J.I. ARAGONES y J.A. CORRALIZA (Coord).

Comportamiento y medio ambiente. La Psicología Ambiental en España.

683-693.

RAUSH, H.L. (1.965).

Interaction Sequences.

Journal of Personality and Social Psychology.

2,487-499.

ROSCH, E. (1.973).
Natural categories.

Cognitive Psychology.
4, 328-335

ROSCH, E. (1.978).
Principles of categorization. In E. ROSCH & B.B. LLOYD (Eds.)

Cognition and categorization.
New York: Wiley, 28-46.

SACKETT, G.P., RUPPENTHAL, G.C. & GLUCK, J. (1.978).

Introduction: An overview of methodological and statistical problems in observational research. In G.P. SACKETT (Ed)

Observing Behavior: Data collection and analysis methods.
Baltimore: University Park Press. 1-14

SACKETT, G.P.; HOLM, R.; CROWLEY, C. & HENKINS, A. (1979).

A Fortran program for lag sequential analysis of contingency and cyclicity in behavioral interaction data

Behavior Research Methods & Instrumentation.
11, 366-378,

SAINZ, J. (1.984).

Hacia un nuevo modelo de categorización. En J. MAYOR (Ed.)

Actividad humana y procesos cognitivos.
Madrid: Alhambra, 81-103.

SMULYAN, L. (1984).

Collaborative Action Research: Historical trends. Paper presented at the Annual Meeting of the American Educational Research Association.

New Orleans

THOMAN, E.B., ACEBO, C. & BECKER, P.T. (1977).

Infant crying and stability in the mother-infant relationship: A systems analysis.

Child Development.
54, 653-659.

THOMAS, E.A.C. & MARTIN, J.A. (1.976).

Analysis of parent-infant interaction.

Psychological Review,
83, 141-156.

VAN HOOFF, J.A. (1.973).

A structural analysis of the social behavior of a semi-captive group of chimpanzees. In M. VON CRANACH I. VINE (Eds.)

Expressive movements and non-verbal communication.
London: Academic Press. 75-162.

2ª PART

WATERS, E. (1.981).

Traits, behavioral systems, and relationships: three models of infant-adult attachment. In K. IMMELMAL, G.W & others. (Eds.).
Behavioral Development.

Cambridge:University Press.621-650.

WRAGG, E.C. (1.970).

Interaction analysis as a feedback system for student teachers.

Education for Teaching.

81.

9.- Índex.

VOLUM I

PRESENTACIÓ.....	7
------------------	---

I. PRIMERA PART: Interacció entre iguals i Teoria de l'Educació.

1.- L'Educació entesa com relació.....	11
1.1.- Diferències entre l'educació entesa com resultat i entesa com acció.....	13
1.2.- La relació comunicativa com consistència del procés educatiu.....	17
1.3.- L'acció pedagògica com optimitzadora de la interacció educativa.....	25
2.- Importància de la interacció entre iguals i entre diferents.....	34
2.1.- Enfocaments teòrics i pràctics sobre la "interacció entre iguals" en el desenvolupament i l'aprenentatge.....	39
2.1.1.- Enfocament cognitiu-evolutiu.....	45
2.1.2.- Enfocament vigotsquià.....	52
2.1.3.- Enfocament sòcio-grupal.....	55
2.1.4.- Enfocament de les teories de l'aprenentatge social.....	56
2.1.5.- Enfocament etològic.....	60
2.2.- Consideracions al voltant de la interacció entre diferents.....	63

9.- Index.

VOLUM I

PRESENTACIÓ.....	7
------------------	---

I. PRIMERA PART: Interacció entre iguals i Teoria de l'Educació.

1.- L'Educació entesa com relació.....	11
1.1.- Diferències entre l'educació entesa com resultat i entesa com acció.....	13
1.2.- La relació comunicativa com consistència del procés educatiu.....	17
1.3.- L'acció pedagògica com optimitzadora de la interacció educativa.....	25
2.- Importància de la interacció entre iguals i entre diferents.....	34
2.1.- Enfocaments teòrics i pràctics sobre la "interacció entre iguals" en el desenvolupament i l'aprenentatge.....	39
2.1.1.- Enfocament cognitiu-evolutiu.....	45
2.1.2.- Enfocament vigotsquià.....	52
2.1.3.- Enfocament sòcio-grupal.....	55
2.1.4.- Enfocament de les teories de l'aprenentatge social.....	56
2.1.5.- Enfocament etològic.....	60
2.2.- Consideracions al voltant de la interacció entre diferents.....	63

3.- Construcció de coneixement sobre l'educació i metodologia observacional.....	73
3.1.- Construcció de coneixement sobre l'educació i "teoria de l'educació".....	74
3.2.- El mètode científic i metodologies específiques.....	83
3.3.- Paradigmes en la investigació educativa.....	93
3.4.- Orígens de la metodologia de l'observació en l'àmbit de la pedagogia.....	118
3.5.- Possibilitats de la metodologia observacional en relació amb altres metodologies per a la construcció de coneixement en teoria de l'educació.....	130
4.- Formulació de la tesi.....	150

II. SEGONA PART: Construcció d'un sistema de categories per a l'estudi de la interacció entre iguals.

5.- Introducció.....	153
6.- La metodologia observacional com a mètode d'investigació a l'aula.....	165
6.1.- Principals aspectes de l'observació sistemàtica com a mètode d'investigació.....	166
6.1.1.- Fases de l'Observació Sistemàtica com a mètode.....	169
6.1.2.- Usos pràctics de l'observació sistemàtica: Alguns exemples d'observació sistemàtica.....	170
6.1.3.- Accés a situacions educatives.....	175

6.2.-Disseny del programa d'investigació a l'aula.....	178
6.2.1. Delimitació d'objectius i definició de variables per a l'observació.....	178
6.2.2.-Subjectes, lloc i període d'observació.....	183
6.2.3.-Esbiaixos i dificultats específiques.....	187
6.2.4.-Procés de categorització.....	189
6.2.4.1.- Categories i definició (Observació sistematitzada).....	204
6.2.4.2.- Marcs de conducta.....	222
6.2.5.- Registre observacional.....	224
6.2.5.1.- Plantilla de registre.....	228
6.2.6.- Mostratge observacional.....	234
6.2.6.1.-Observacions en el context.....	238
6.2.6.2.-Observacions en el temps.....	238
6.2.7.- Fiabilitat: Acord entre observadors.....	241
6.2.7.1.-Fiabilitat consensuada.....	241
6.2.8.-Anàlisi de les dades observacionals.....	243
6.2.8.1.- Fases de l'anàlisi.....	243
6.2.8.2.- Mesures globals.....	243
6.2.8.3.- Anàlisi seqüencial de retard.....	257
6.2.8.3.1.- Procés de reducció de dades i gràfiques polars.....	258
7.- Conclusions.....	292
8.- Bibliografia consultada.....	297
8.1.- Relativa a la primera part.....	299
8.2.- Relativa a la segona part.....	316

9.- Índex.....	336
-----------------------	------------

VOLUM II

10. - Annexos.....	340
10.1.- Formats de camp per cada activitat.....	343
10.2.- Dades relatives a les sessions d'observació agrupades segons el tipus d'organització social de les situacions.....	462
10.3.- Manual del programa ASR.....	484
10.4.- Tractament de les dades amb el programa ASR.....	497
10.5.- Gràfiques de probabilitats condicionades per a cadascuna de les conductes criteri.....	673
10.6.- Dades relatives a les conductes activades i inhibides en funció de les conductes criteri.....	713

10. - Annexos.

- 10.1.- Formats de camp per cada activitat.
- 10.2.- Dades relatives a les sessions d'observació agrupades segons el tipus d'organització social de les situacions.
- 10.3.- Manual del programa ASR.
- 10.4.- Tractament de les dades amb el programa ASR.
- 10.5.- Gràfiques de probabilitats condicionades per a cadascuna de les conductes criteri.
- 10.6.- Dades relatives a les conductes activades i inhibides en funció de les conductes criteri.

10.- Annexos.

10.1.- Formats de camp de cada activitat.

Ind	1		
1	UV02	US06	
Ind	2		
1	UV02	US13	
Ind	3		
2	UV02	US02	
Ind	4		
1	UV02	US07	
Ind	5		
1	UV02	US02	
Ind	6		
2	UV3	US02	
Ind	7		
2	UV02	US02	
Ind	8		
2	UV3	US02	
Ind	9		
2	UV02	US02	VC10
Ind	10		
2	UV02	US02	
Ind	11		
2	UV12	US02	
Ind	12		
3	UV12	US02	LC10
Ind	13		
2	UV12	US02	
Ind	14		
1	UV02	US02	
Ind	15		
2	UV03	US02	
Ind	16		
1	UV02	US02	VC07
Ind	17		
1	UV02	US02	

Ind	18				
4					
UV02	US13				
Ind	19				
1					
UV06	US13				
Ind	20				
1					
UV02	US13			AU02	
Ind	21				
1					
UV02	US07				
Ind	22				
1					
UV02	US06				
Ind	23				
1					
UV02	US13			AU02	
Ind	24				
2					
UV02	US13				
Ind	25				
2					
UV02	US02				
Ind	26				
1					
UV02	US07				
Ind	27				
1					
UV06	US02			LC10	
Ind	28				
4					
UV12	US02	CF3		LC10	
Ind	29				
3					
UV12	US02	CF3	VC07	LC10	
Ind	30				
3					
UV10	US02		VC09		
Ind	31				
1					
UV10	US02				
Ind	32				
3					
UV02	US02				
Ind	33				
1					
UV02	US13				
Ind	34				
1					
UV02	US13		VC05		

Ind	35
1	
UV02	US13

Ind	154			
1				
UV02	US13			
Ind	155			
1				
UV02	US13			
Ind	156			
1				
UV02	US13			AU06
Ind	157			
5				
UV12	US02			AU06
Ind	163			
2				
UV02	US13			
Ind	164			
1				
UV02	US02			
Ind	165			
5				
UV02	US13			
Ind	170			
2				
UV12	US02			
Ind	172			
1				
UV03	US02			
Ind	173			
1				
UV12	US2			
Ind	174			
1				
UV13	US02		LC10	
Ind	175			
1				
UV13	US02		VC07	LC10
Ind	176			
2				
UV13	US02		VC07	
Ind	178			
1				
UV03	US02			
Ind	179			
1				
UV02	US02			
Ind	180			
2				
UV02	US13		VC07	
Ind	182			
2				
UV02	US13			

Ind	184			
3				
UV02	US13		VC07	
Ind	187			
1				
UV02	US13			
Ind	188			
1				
UV03	US02			
Ind	189			
1				
UV02	US13			
Ind	190			
1				
UV03	US13			
Ind	191			
1				
UV12	US02		VC07	
Ind	192			
1				
UV03	US02			
Ind	193			
2				
UV03	US02		VC07	
Ind	195			
5				
UV02	US13			
Ind	200			
1				
UV03	US02			LC10
Ind	201			
1				
UV13	US02		VC07	LC10
Ind	202			
2				
UV13	US02			
Ind	204			
1				
UV10	US02			
Ind	205			
1				
UV10	US02		VC07	
Ind	206			
4				
UV02	US13			
Ind	210			
1				
UV02	US13		VC07	
Ind	211			
2				
UV02	US02		VC07	

Ind	213
↑	
UV02	US02

Ind	224		
4			
UV02	US09		
Ind	225		
1			
UV03	US09		
Ind	226		
16			
UV02	US09		
Ind	227		
1			
UV10	US09	VC07	
Ind	228		
1			
UV03	US09	VC07	
Ind	229		
1			
UV10	US09	VC07	
Ind	230		
2			
UV03	US09	VC07	
Ind	231		
2			
UV10	US9	VC8	
Ind	232		
3			
UV02	US09	VC08	
Ind	233		
4			
UV03	US09		
Ind	234		
1			
UV02	US02		
Ind	235		
4			
UV02	US09		
Ind	236		
1			
UV03	US09	VC07	
Ind	237		
2			
UV10	US09	VC07	
Ind	238		
8			
UV10	US09		
Ind	239		
4			
UV10		LC01	
Ind	240		
1			
UV10			

Ind	241
1	
UV10	US09
Ind	242
3	
UV12	US09

Ind	243		
8			
UV02	US09		
Ind	244		
3			
UV03	US09	VC07	
Ind	245		
4			
UV02	US09	VC07	
Ind	246		
2			
UV10	US09	VC07	
Ind	247		
2			
UV03	US09		
Ind	248		
1			
UV03	US09	VC07	
Ind	249		
1			
UV03	US09		
Ind	250		
1			
UV12	US09		
Ind	251		
1			
UV10	US09		
Ind	252		
2			
UV02	US09		
Ind	253		
1			
UV06	US09		
Ind	254		
2			
UV02	US09		
Ind	255		
1			
UV06	US09		
Ind	256		
1			
UV15	US09		
Ind	257		
1			
UV06	US09		
Ind	258		
2			
UV02	US09		
Ind	259		
2			
UV03	US09		

Ind	260			
2				
UV02	US09		VC07	
Ind	261			
1				
UV02	US09			
Ind	262			
1				
UV02	US09		VC07	
Ind	263			
1				
UV02	US02			AU06
Ind	264			
3				
UV14	US02			AU06
Ind	265			
6				
UV02	US09			AU06
Ind	266			
2				
UV03	US02			AU06
Ind	267			
2				
UV14	US02			
Ind	268			
1				
UV06	US02			AU06
Ind	269			
1				
UV14	US02			AU06
Ind	270			
2				
UV02	US02			AU06
Ind	271			
1				
UV12				AU06
Ind	272			
1				
UV10			VC07	AU06
Ind	273			
1				
UV10				AU06

Ind	585		
3			
UV03		VC07	
Ind	586		
3			
UV03			
Ind	587		
1			
UV06			
Ind	588		
4			
UV03			
Ind	589		
4			
UV03			
Ind	590		
2			
UV02			
Ind	591		
3			
UV04			
Ind	592		
2			
UV03			
Ind	593		
1			
UV02			
Ind	594		
2			
UV02	US05		
Ind	595		
1			
UV01	US05		
Ind	596		
1			
UV07	US05		
Ind	597		
7			
UV02	US13		
Ind	598		
1			
UV02			
Ind	599		
1			
UV10			
Ind	600		
1			
UV06			
Ind	601		
3			
UV02			

Ind	602		
2			
UV02	US13		
Ind	603		
2			
UV02			
Ind	604		
2			
UV03			
Ind	605		
1			
UV11			
Ind	606		
1			
UV11	US05	VC08	
Ind	607		
1			
UV11	US08	VC08	
Ind	608		
3			
UV11	US02		
Ind	609		
1			
UV11			
Ind	610		
1			
UV11	US08		
Ind	611		
1			
UV03	US06		
Ind	612		
3			
UV03			
Ind	613		
2			
UV03	US05		
Ind	614		
2			
UV03			AU06

Ind	777			
1				
UV02				
Ind	778			
3				
UV02	US13			
Ind	779			
1				
UV02	US05			
Ind	780			
1				
UV02				
Ind	781			
1				
UV02	US13			
Ind	782			
1				
UV06				
Ind	783			
1				
UV06	US02	VC07	LC17	
Ind	784			
2				
UV02	US02	VC07		
Ind	785			
1				
UV02	US12			
Ind	786			
3				
UV02	US02			
Ind	787			
2				
UV02	US12			
Ind	788			
2				
UV15	US12	VC06		
Ind	789			
1				
UV15	US02			
Ind	790			
2				
UV15	US13			
Ind	791			
2				
UV15	US06			
Ind	792			
5				
UV15				
Ind	793			
5				
UV15	US05			

Ind	794		
4			
UV15	US05		
Ind	795		
1			
UV15	US05		
Ind	796		
2			
UV15	US13		
Ind	797		
1			
UV15	US13		AU02
Ind	798		
2			
UV15	US12		AU02
Ind	799		
2			
UV15	US13		
Ind	800		
2			
UV15	US12		
Ind	801		
2			
UV15	US12		AU02
Ind	802		
1			
UV15	US12		
Ind	803		
1			
UV15			AU06
Ind	804		
4			
UV15	US13		
Ind	805		
1			
UV02			
Ind	806		
2			
UV02	US12		
Ind	807		
1			
UV02	US01		

Ind	991		
1			
UV03	US02		
Ind	992		
1			
UV02	US05		
Ind	993		
1			
UV03	US02		
Ind	994		
1			
UV03	US03		AU06
Ind	995		
1			
UV13	US02	VC07	
Ind	996		
1			
UV02	US13		
Ind	997		
1			
UV06	US13		
Ind	998		
6			
UV02	US13		
Ind	999		
1			
UV02	US13	VC07	
Ind	1.000		
1			
UV06		VC07	
Ind	1.001		
5			
UV10	US02	VC07	
Ind	1.002		
6			
UV02	US13		
Ind	1.003		
4			
UV03	US02		
Ind	1.004		
1			
UV08	US02		
Ind	1.005		
1			
UV06	US02		
Ind	1.006		
4			
UV02	US02		
Ind	1.007		
1			
UV06	US02		

Ind	1.008		
2			
UV02	US13		
Ind	1.009		
1			
UV02	US13	VC07	
Ind	1.010		
4			
UV02	US13		
Ind	1.011		
2			
UV02	US13	VC07	
Ind	1.012		
14			
UV02	US13		
Ind	1.013		
1			
UV02	US13	CF4	

Ind	743			
2				
UV02	US02			AU07
Ind	744			
5				
UV03	US02			AU06
Ind	745			
1				
UV02	US02		LC10	
Ind	746			
2				
UV02	US02			
Ind	747			
4				
UV01	US02		LC03	
Ind	748			
2				
UV03	US02		LC10	
Ind	749			
2				
UV03	US02			
Ind	750			
2				
UV03	US06		LC10	
Ind	751			
1				
UV06				
Ind	752			
2				
UV03				
Ind	753			
3				
UV03		CF3		
Ind	754			
2				
UV03		CF3	LC17	
Ind	755			
2				
UV03				
Ind	756			
2				
UV03			LC17	
Ind	757			
1				
UV09	US02		LC01	
Ind	758			
1				
UV02	US02		LC01	
Ind	759			
1				
UV02	US02		LC03	

Ind	760		
2			
UV02	US02		
Ind	761		
1			
UV02			
Ind	762		
1			
UV02	US05		
Ind	763		
1			
UV02			
Ind	764		
2			
UV02	US02		LC10
Ind	765		
2			
UV02	US13		
Ind	766		
1			
UV02	US06		
Ind	767		
1			
UV02	US05		
Ind	768		
3			
UV02	US13		
Ind	769		
1			
UV02	US13		VC07
Ind	770		
2			
UV02	US13		
Ind	771		
1			
UV02	US06		
Ind	772		
1			
UV02	US05		
Ind	773		
1			
UV02			LC01
Ind	774		
2			
UV04			VC08
Ind	775		
11			
UV02			
Ind	776		
2			
UV07			

Ind	807			
1				
UV02	US01			
Ind	842			
1				
UV02	US02			
Ind	843			
5				
UV02	US13			
Ind	844			
1				
UV10	US05	VC07	LC10	
Ind	845			
3				
UV10	US02	VC07		
Ind	846			
2				
UV10	US02			
Ind	847			
3				
UV02	US13			
Ind	848			
1				
UV02	US06			
Ind	849			
1				
UV02	US13			
Ind	850			
4				
US02	US13	VC07		
Ind	851			
12				
UV02	US13			
Ind	852			
2				
UV02	US02	VC07		
Ind	853			
1				
UV02	US13	VC05		
Ind	854			
2				
UV02	US13			
Ind	855			
1				
UV06	US13			
Ind	856			
1				
UV02				
Ind	857			
1				
UV06		CF3		

Ind	858	
1		
UV02		CF4
Ind	859	
1		
UV03		
Ind	860	
2		
UV02	US02	
Ind	861	
10		
UV02		
Ind	862	
4		
UV11		VC08

Ind	964		
1			
UV02	US02		
Ind	965		
1			
UV02	US13		
Ind	966		
2			
UV03	US02		
Ind	967		
1			
UV03	US02		LC17
Ind	968		
10			
UV02	US13		
Ind	969		
4			
UV02	US05		
Ind	970		
1			
UV01	US02		AU08
Ind	971		
5			
UV04	US02		
Ind	972		
6			
UV02	US13		
Ind	973		
2			
UV03	US02		
Ind	974		
1			
UV02	US02		VC07
Ind	975		
4			
UV02	US05		
Ind	976		
2			
UV02	US13		
Ind	977		
1			
UV02	US06		
Ind	978		
1			
UV06	US06		VC07
Ind	979		
1			
UV02	US02		
Ind	980		
1			
UV02	US13		

Ind	981		
1			
UV03	US02		VC07
Ind	982		
3			
UV02	US13		
Ind	983		
1			
UV02	US05		VC07
Ind	984		
1			
UV06			
Ind	985		
1			
UV02	US02		
Ind	986		
1			
UV02	US13		
Ind	987		
2			
UV02	US06		
Ind	988		
2			
UV02	US05		
Ind	989		
1			
UV02	US02		
Ind	990		
2			
UV02	US13		

Ind	1.086			
4				
UV02	US02			
Ind	1.087			
2				
UV03	US02			
Ind	1.088			
2				
UV02	US02			
Ind	1.089			
3				
UV03				
Ind	1.090			
8				
UV02	US08			
Ind	1.091			
3				
UV02	US02			
Ind	1.092			
1				
UV03	US02			
Ind	1.093			
1				
UV03	US02		LC17	
Ind	1.094			
4				
UV03	US02			
Ind	1.095			
1				
UV06	US02			
Ind	1.096			
4				
UV02	US02			
Ind	1.097			
1				
UV02	US02	VC05	LC17	
Ind	1.098			
1				
UV02	US04			
Ind	1.099			
1				
UV02	US06			
Ind	1.100			
6				
UV02	US02			
Ind	1.101			
1				
UV04		VC05		
Ind	1.102			
1				
UV04	US02	VC05		

Ind	1.103
17	
UV04	US02

Ind	1.104			
1				
UV02	US02			
Ind	1.106			
1				
UV02	US02			
Ind	1.107			
1				
UV09	US02			
Ind	1.108			
4				
UV03	US02			
Ind	1.109			
1				
UV03	US02		LC17	
Ind	1.110			
3				
UV03	US02			
Ind	1.111			
1				
UV03	US02		LC17	
Ind	1.112			
1				
UV03	US02			AU06
Ind	1.113			
1				
UV03	US02		LC17	
Ind	1.114			
2				
UV03	US02			AU06
Ind	1.115			
1				
UV03	US02		LC17	AU06
Ind	1.116			
3				
UV03	US02			AU06
Ind	1.117			
1				
UV03	US02		LC17	AU06
Ind	1.118			
1				
UV03	US02			AU06
Ind	1.119			
1				
UV03	US02		LC17	AU06
Ind	1.120			
2				
UV03	US02			AU06
Ind	1.121			
1				
UV03	US02		LC17	AU06

Ind 1	1.122		
UV03	US02		AU04
Ind 11	1.123		
UV05			AU04
Ind 5	1.124		
UV03	US02		
Ind 3	1.125		
UV02			
Ind 1	1.126		
UV07			
Ind 3	1.127		
UV02			
Ind 1	1.128		
UV07			
Ind 6	1.129		
UV02			

Ind	1.060			
1				
UV02	US02			
Ind	1.061			
2				
UV02	US13			
Ind	1.062			
1				
UV03	US02			
Ind	1.063			
8				
UV02	US13			
Ind	1.064			
1				
UV13	US02			
Ind	1.065			
6				
UV02	US13			
Ind	1.066			
1				
UV03	US02	VC07		LC17
Ind	1.067			
1				
UV03	US02			
Ind	1.068			
3				
UV02	US13			
Ind	1.069			
1				
UV10				
Ind	1.070			
3				
UV02	US02			
Ind	1.071			
2				
UV10	US02			
Ind	1.072			
4				
UV02	US02			
Ind	1.073			
1				
UV13	US02			
Ind	1.074			
2				
UV02	US02			
Ind	1.075			
1				
UV02	US02	CF3		LC10
Ind	1.076			
1				
UV02	US02			

Ind	1.077			
1				
UV02	US02	CF3	VC07	
Ind	1.078			
2				
UV13	US02			
Ind	1.079			
1				
UV02	US02			
Ind	1.080			
4				
UV02	US13			
Ind	1.081			
1				
UV03	US02			
Ind	1.082			
1				
UV14	US02			
Ind	1.083			
2				
UV03	US02			
Ind	1.084			
1				
UV03	US02		LC17	
Ind	1.085			
8				
UV03	US02			

Ind	1.042		
1			
UV02	US02		
Ind	1.043		
1			
UV02	US13		
Ind	1.044		
2			
UV01	US02	CF4	
Ind	1.045		
1			
UV01	US02		
Ind	1.046		
4			
UV03	US02		
Ind	1.047		
2			
UV02	US02		
Ind	1.048		
11			
UV02	US13		
Ind	1.049		
1			
UV03	US02		
Ind	1.050		
1			
UV10	US02		
Ind	1.051		
3			
UV10	US02	VC07	
Ind	1.052		
2			
UV10	US02		
Ind	1.053		
2			
UV02	US02		
Ind	1.054		
1			
UV02	US02		AU06
Ind	1.055		
4			
UV02	US13		AU06
Ind	1.056		
11			
UV13	US02		AU06
Ind	1.057		
3			
UV13	US02		AU08
Ind	1.058		
5			
UV03	US02		AU08

Ind	1.059		
5			
UV01	US02		AU08

Ind	1.751			
1				
UV02	US13			
Ind	1.752			
1				
UV02	US13			
Ind	1.753			
1				
UV02	US02			
Ind	1.754			
1				
UV02	US09			
Ind	1.755			
5				
UV02	US13			
Ind	1.756			
1				
UV03	US13			
Ind	1.757			
1				
UV06	US09			
Ind	1.758			
1				
UV03	US09			
Ind	1.759			
1				
UV14	US09			
Ind	1.760			
1				
UV06	US13			
Ind	1.761			
1				
UV02	US13			
Ind	1.762			
1				
UV10	US13			
Ind	1.763			
12				
UV01	US02	VC07		
Ind	1.764			
2				
UV03	US02	VC07		
Ind	1.765			
1				
UV03	US02	VC07	LC01	
Ind	1.766			
3				
UV02	US07	VC07	LC01	
Ind	1.767			
1				
UV03		VC07		

Ind 7 INOB	1.768			
Ind 1 UV01	1.769		LC01	
Ind 3 UV01	1.770		VC07	LC01
Ind 1 UV02	1.771	US06	VC07	LC01
Ind 1 UV02	1.772	US06	VC07	LC01
Ind 1 UV02	1.773	US09	VC07	
Ind 1 UV02	1.774	US14	VC07	
Ind 4 UV02	1.775	US14		
Ind 1 UV04	1.776	US14		
Ind 3 UV02	1.777	US02		
Ind 3 UV02	1.778	US13		

Ind	1.779		
4			
UV02	US09		
Ind	1.780		
1			
UV03	US09		
Ind	1.781		
16			
UV02	US09		
Ind	1.782		
1			
UV10	US09	VC09	
Ind	1.783		
1			
UV03	US09	VC07	
Ind	1.784		
1			
UV10	US09	VC07	
Ind	1.785		
2			
UV03	US09	VC07	
Ind	1.786		
2			
UV10	US09	VC08	
Ind	1.787		
3			
UV11	US09	VC08	
Ind	1.788		
4			
UV03	US09		
Ind	1.789		
1			
UV02	US02		
Ind	1.790		
4			
UV02	US09		
Ind	1.791		
1			
UV03	US09	VC07	
Ind	1.792		
2			
UV10	US09	VC07	
Ind	1.793		
8			
UV10	US09		
Ind	1.794		
4			
UV10		LC01	
Ind	1.795		
1			
UV10			

Ind	1.796
1	
UV10	US09
Ind	1.797
3	
UV13	US09

Ind 1	1.837		
UV15		VC05	AU14
Ind 5	1.838		
UV15		VC05	
Ind 2	1.839		
UV15	US13	VC05	
Ind 1	1.840		
UV06	US13	VC05	
Ind 5	1.841		
UV15	US13	VC05	
Ind 3	1.842		
UV15	US07	VC06	
Ind 1	1.843		
UV03	US07	VC06	
Ind 1	1.844		
UV03	US07	VC07	
Ind 1	1.845		
UV15	US07	VC07	
Ind 2	1.846		
UV15	US10	VC09	
Ind 2	1.847		
UV03	US10	VC09	
Ind 2	1.848		
UV03		VC07	
Ind 1	1.849		
UV15	US13	VC07	
Ind 2	1.850		
UV03	US13	VC07	
Ind 3	1.851		
UV03	US13		
Ind 5	1.852		
UV15	US13		
Ind 24	1.853		
UV15	US13	VC05	

Ind	1.868		
2			
UV03	US13		
Ind	1.869		
15			
UV13	US13		
Ind	1.870		
2			
UV03	US07		
Ind	1.871		
1			
UV03	US07		VC07
Ind	1.872		
1			
UV13	US07		VC07
Ind	1.873		
1			
UV10	US13		VC09
Ind	1.874		
1			
UV13	US13		VC07
Ind	1.875		
1			
UV13	US07		LC16
Ind	1.876		
1			
UV02	US07		VC09
Ind	1.877		
1			
UV02	US07		VC07
Ind	1.878		
4			
UV10	US07		VC09
Ind	1.879		
1			
UV10	US07		LC16
Ind	1.880		
1			
UV02	US07		
Ind	1.881		
12			
UV13	US13		
Ind	1.882		
1			
UV03	US13		
Ind	1.883		
10			
UV13	US13		
Ind	1.884		
1			
UV13	US05		LC16

Ind	1.885
4	
UV13	US13

Ind	36			
2				
UV02	US13			
Ind	37			
1				
UV02	US13		AU06	
Ind	38			
5				
UV12	US02		AU06	
Ind	39			
2				
UV03	US13			
Ind	40			
1				
UV02	US02			
Ind	41			
5				
UV02	US13			
Ind	42			
2				
UV12	US02			
Ind	43			
1				
UV03	US02			
Ind	44			
1				
UV12	US02			
Ind	45			
1				
UV12	US02		LC02	
Ind	46			
1				
UV12	US02	VC07	LC02	
Ind	47			
2				
UV12	US02	VC07		
Ind	48			
1				
UV03	US02			
Ind	49			
1				
UV02	US02			
Ind	50			
2				
UV02	US13	VC07		
Ind	51			
2				
UV02	US13			
Ind	52			
3				
UV02	US13	VC07		

Ind	53		
1			
UV02	US13		
Ind	54		
1			
UV03	US02		
Ind	55		
1			
UV02	US13		
Ind	56		
1			
UV03	US13		
Ind	57		
1			
UV15	US02	VC07	
Ind	58		
1			
UV03	US02		
Ind	59		
2			
UV03	US02	VC07	
Ind	60		
5			
UV02	US13		
Ind	61		
1			
UV03	US02	LC02	
Ind	62		
1			
UV12	US02	VC07	
Ind	63		
2			
UV12	US02		
Ind	64		
1			
UV10	US02		

Ind	463		
2			
UV02	US02		AU06
Ind	464		
13			
UV02	US13		AU06
Ind	465		
9			
UV02	US02		AU06
Ind	466		
1			
UV02	US02		AU06
Ind	467		
11			
UV02	US02		
Ind	468		
2			
UV13	US02		
Ind	469		
3			
UV09	US02		
Ind	470		
1			
UV06	US02		
Ind	471		
1			
UV12	US02		
Ind	472		
3			
UV12	US02		
Ind	473		
3			
UV03	US02		
Ind	474		
1			
UV08	US02		
Ind	475		
7			
UV02	US02		
Ind	476		
2			
UV02	US02		
Ind	477		
2			
UV13	US02		

Ind	585		
1			
UV16	US13		VC07
Ind	586		
1			
UV15	US13		VC07
Ind	587		
1			
UV16	US13		VC07
Ind	588		
1			
UV10	US13		VC07
Ind	589		
2			
UV10	US13		VC09
Ind	590		
1			
UV15	US07		VC09
Ind	591		
2			
UV16	US07		VC09
Ind	592		
6			
UV15	US13		VC07
Ind	593		
4			
UV16	US13		VC09
Ind	594		
1			
UV06	US13		
Ind	595		
37			
UV15	US13		
Ind	596		
1			
UV03	US07		
Ind	597		
1			
UV03	US07		VC07
Ind	598		
1			
UV03	US01		VC07

Ind	478		
1			
UV15	US07		VC09
Ind	479		
1			
UV03	US07		VC09
Ind	480		
1			
UV15	US07		VC09
Ind	481		
1			
UV09	US07		VC07
Ind	482		
1			
UV03	US07		VC07
Ind	483		
2			
UV03	US13		VC07
Ind	484		
1			
UV15	US13		VC09
Ind	485		
2			
UV15	US13		VC07
Ind	486		
29			
UV15	US13		
Ind	487		
1			
UV07	US13		
Ind	488		
8			
UV15	US13		
Ind	489		
1			
UV15	US06		
Ind	490		
1			
UV13	US05		
Ind	491		
2			
UV13	US08		
Ind	492		
1			
UV15	US08		
Ind	493		
1			
UV06	US13		
Ind	494		
6			
UV15	US13		

Col	808			
2				
UV03	US02			
Col	809			
3				
UV04	US02			
Col	810			
1				
UV03	US02			
Col	811			
1				
UV03	US02		LC10	
Col	812			
1				
UV03	US02	VC08	LC10	
Col	813			
1				
UV12	US02	VC08		
Col	814			
2				
UV12	US02			
Col	815			
3				
UV02	US02			
Col	816			
1				
UV06	US02	VC08		
Col	817			
1				
UV15	US02	VC08		
Col	818			
2				
UV11	US02	VC08		
Col	819			
10				
UV02	US02			
Col	820			
1				
UV06	US02			
Col	821			
1				
UV07	US02			
Col	822			
1				
UV02	US02	VC06		
Col	823			
3				
UV02	US02			
Col	824			
1				
UV02				

Col	825			
1				
UV06				
Col	826			
1				
UV02				
Col	827			
3				
UV03				
Col	828			
1				
UV06				
Col	829			
1				
UV07			VC08	
Col	830			
1				
UV03	US02			
Col	831			
3				
UV03				
Col	832			
1				
UV03		CF6		LC10
Col	833			
3				
UV10				LC10
Col	834			
1				
UV03			CF6	LC10
Col	835			
1				
UV04			CF6	
Col	836			
1				
UV15				
Col	837			
1				
UV04				
Col	838			
1				
UV02			CF6	
Col	839			
1				
UV04				VC08
Col	840			
4				
UV03				
Col	841			
1				
UV02	US01			

Col	863		
1			
UV11			
Col	864		
1			
UV11			AU06
Col	865		
1			
UV09			
Col	866		
1			
UV13			
Col	867		
1			
UV11			LC10
Col	868		
1			
UV10			
Col	869		
1			
UV11			
Col	870		
1			
UV15			
Col	871		
1			
UV02	US07		
Col	872		
1			
UV02	US12		
Col	873		
1			
UV11	US02		VC05
Col	874		
1			
UV14	US02		
Col	875		
1			
UV11	US02		
Col	876		
1			
UV11	US02		AU05
Col	877		
1			
UV11	US02		LC01
Col	878		
1			
UV03	US02		
Col	879		
1			
UV03	US02		VC08

Col	880			
1				
UV03	US02			LC09
Col	881			
1				
UV03	US04			LC09
Col	882			
1				
UV03	US03		VC08	LC10
Col	883			
1				
UV11			VC08	
Col	884			
1				
UV11	US02			
Col	885			
2				
UV03	US02			LC10
Col	886			
1				
UV03	US02			
Col	887			
1				
UV13	US02		VC07	
Col	888			
1				
UV06	US02			
Col	889			
1				
UV13	US02			
Col	890			
1				
UV03	US02			
Col	891			
1				
UV07	US02		VC05	
Col	892			
1				
UV03	US02			
Col	893			
1				
UV02	US02		VC06	
Col	894			
1				
UV02	US08		VC06	
Col	895			
1				
UV02	US08			
Col	896			
1				
UV02	US08			AU02

Col	897		
1			
UV02	US02		
Col	898		
1			
UV02	US08		
Col	899		
1			
UV03	US02		
Col	900		
1			
UV03	US02	VC06	
Col	901		
3			
UV03	US02		
Col	902		
1			
UV03	US02	LC17	
Col	903		
3			
UV03	US02		
Col	904		
2			
UV01	US02		
Col	905		
4			
UV10	US02		
Col	906		
3			
UV03	US02		
Col	907		
1			
UV01	US02		
Col	908		
1			
UV10	US02		
Col	909		
3			
UV14	US02		

Col	910		
1			
UV15	US02		
Col	911		
1			
UV06	US02		
Col	912		
1			
UV07	US02		
Col	913		
3			
UV03	US02		
Col	914		
3			
UV02	US02		
Col	915		
1			
UV03	US02		
Col	916		
1			
UV07	US02		
Col	917		
1			
UV15	US02		
Col	918		
1			
UV04	US02		AU04
Col	919		
2			
UV04	US02		AU06
Col	920		
1			
UV06	US02		
Col	921		
2			
UV06	US02		LC17
Col	922		
1			
UV06	US02		
Col	923		
1			
UV06	US02		LC17
Col	924		
1			
UV06	US02		
Col	925		
2			
UV04	US02		
Col	926		
5			
UV06	US02		

Col	927		
2			
UV01	US02		
Col	928		
1			
UV06	US02		
Col	929		
2			
UV01	US02		
Col	930		
1			
UV01	US02		LC01
Col	931		
2			
UV01	US02		
Col	932		
1			
UV06	US01		VC08
Col	933		
1			
UV04	US01		VC08
Col	934		
3			
UV04	US02		
Col	935		
1			
UV04	US04		
Col	936		
2			
UV04	US04		LC01
Col	937		
1			
UV02	US02		VC07
Col	938		
3			
UV02	US02		
Col	939		
1			
UV06	US02		
Col	940		
1			
UV15	US02		
Col	941		
1			
UV06	US02		
Col	942		
4			
UV07	US02		
Col	943		
5			
UV03	US02		

Col	863		
1			
UV11			
Col	864		
1			
UV11			AU06
Col	865		
1			
UV09			
Col	866		
1			
UV13			
Col	867		
1			
UV11			LC10
Col	868		
1			
UV10			
Col	869		
1			
UV11			
Col	870		
1			
UV15			
Col	871		
1			
UV02	US07		
Col	872		
1			
UV02	US12		
Col	873		
1			
UV11	US02		VC05
Col	874		
1			
UV14	US02		
Col	875		
1			
UV11	US02		
Col	876		
1			
UV11	US02		AU05
Col	877		
1			
UV11	US02		LC01
Col	878		
1			
UV03	US02		
Col	879		
1			
UV03	US02		VC08

Col	880			
1				
UV03	US02			LC09
Col	881			
1				
UV03	US04			LC09
Col	882			
1				
UV03	US03		VC08	LC10
Col	883			
1				
UV11			VC08	
Col	884			
1				
UV11	US02			
Col	885			
2				
UV03	US02			LC10
Col	886			
1				
UV03	US02			
Col	887			
1				
UV13	US02		VC07	
Col	888			
1				
UV06	US02			
Col	889			
1				
UV13	US02			
Col	890			
1				
UV03	US02			
Col	891			
1				
UV07	US02		VC05	
Col	892			
1				
UV03	US02			
Col	893			
1				
UV02	US02		VC06	
Col	894			
1				
UV02	US08		VC06	
Col	895			
1				
UV02	US08			
Col	896			
1				
UV02	US08			AU02

Col	897		
1			
UV02	US02		
Col	898		
1			
UV02	US08		
Col	899		
1			
UV03	US02		
Col	900		
1			
UV03	US02	VC06	
Col	901		
3			
UV03	US02		
Col	902		
1			
UV03	US02	LC17	
Col	903		
3			
UV03	US02		
Col	904		
2			
UV01	US02		
Col	905		
4			
UV10	US02		
Col	906		
3			
UV03	US02		
Col	907		
1			
UV01	US02		
Col	908		
1			
UV10	US02		
Col	909		
3			
UV14	US02		

Col 5 UV10	421	
Col 3 UV03	422	
Col 1 UV06	423	
Col 1 UV02	424	
Col 1 UV13	425	
Col 1 UV10	426	
Col 1 UV03	427	
Col 1 UV03	428	LC08
Col 2 UV03	429	
Col 2 UV03	430	
Col 1 UV04	431	
Col 3 UV03	432	
Col 2 UV02	433	
Col 1 UV03	434	
Col 1 UV04	435	
Col 1 UV14	436	
Col 1 UV04	437	

Col	438		
1			
UV03			
Col	439		
1			
UV02			
Col	440		
2			
UV03			
Col	441		
1			
UV04			
Col	442		
1			
UV10			
Col	443		
2			
UV05			
Col	444		
1			
UV05			AU06
Col	445		
7			
UV05			
Col	446		
2			
UV04			
Col	447		
3			
UV03			
Col	448		
1			
UV04		VC06	
Col	449		
9			
UV05			
Col	450		
1			
UV04			

Col 9	615				
UV03					
Col 1	616				
UV06					
Col 1	617				
UV06				LC17	
Col 1	618				
UV10					
Col 1	619				
UV14	US07			LC01	
Col 1	620				
UV14	US08			LC01	
Col 2	621				
UV10					
Col 2	622				
UV14		CF6			
Col 1	623				
UV14		CF6			
Col 1	624				
UV10		CF6			
Col 1	625				
UV10				LC01	
Col 1	626				
UV10			VC07	LC01	
Col 1	627				
UV14			VC07	LC10	
Col 1	628				
UV14		CF6	VC05		
Col 1	629				
UV14		CF6			
Col 9	630				
UV03					
Col 1	631				
UV07			VC08		

Col 1 UV06	632	VC08
Col 1 UV07	633	VC08
Col 7 UV03	634	
Col 1 UV03	635	LC16
Col 3 UV03	636	
Col 3 UV04	637	
Col 3 UV03	638	
Col 1 UV03	639	LC16
Col 4 UV03	640	
Col 1 UV07	641	
Col 1 UV06	642	

Col	1.363			
3				
UV02				
Col	1.364			
5				
UV10		VC07	LC10	
Col	1.365			
1				
UV14				
Col	1.366			
1				
UV05		VC07	LC10	
Col	1.367			
3				
UV05	US01	VC07	LC10	
Col	1.368			
1				
UV05		VC07		
Col	1.369			
1				
UV14			LC10	
Col	1.370			
1				
UV03			LC10	
Col	1.371			
1				
UV10			LC10	
Col	1.372			
1				
UV10				
Col	1.373			
2				
UV10		VC07		
Col	1.374			
2				
UV05		VC07	LC10	
Col	1.375			
1				
UV05		VC07		
Col	1.376			
1				
UV05				
Col	1.377			
2				
UV10				
Col	1.378			
1				
UV10		VC07		
Col	1.379			
1				
UV10			LC10	

Col	1.380		
2			
UV10		VC07	LC10
Col	1.381		
2			
UV10			LC10
Col	1.382		
2			
UV10			
Col	1.383		
1			
UV10	US01	VC07	
Col	1.384		
4			
UV10		VC07	
Col	1.385		
2			
UV10			
Col	1.386		
2			
UV10		VC07	
Col	1.387		
1			
UV14			
Col	1.388		
1			
UV07			
Col	1.389		
5			
UV03			
Col	1.390		
1			
UV03		VC07	
Col	1.391		
3			
UV03			
Col	1.392		
1			
UV04			
Col	1.393		
2			
UV14			
Col	1.394		
2			
UV04			

Col	615			
9				
UV03				
Col	616			
1				
UV06				
Col	617			
1				
UV06			LC17	
Col	618			
1				
UV10				
Col	619			
1				
UV14	US07		LC01	
Col	620			
1				
UV14	US08		LC01	
Col	621			
2				
UV10				
Col	622			
2				
UV14		CF6		
Col	623			
1				
UV14		CF6		
Col	624			
1				
UV10		CF6		
Col	625			
1				
UV10			LC01	
Col	626			
1				
UV10		VC07	LC01	
Col	627			
1				
UV14		VC07	LC10	
Col	628			
1				
UV14		CF6	VC05	
Col	629			
1				
UV14		CF6		
Col	630			
9				
UV03				
Col	631			
1				
UV07			VC08	

Col 1 UV06	632	VC08
Col 1 UV07	633	VC08
Col 7 UV03	634	
Col 1 UV03	635	LC16
Col 3 UV03	636	
Col 3 UV04	637	
Col 3 UV03	638	
Col 1 UV03	639	LC16
Col 4 UV03	640	
Col 1 UV07	641	
Col 1 UV06	642	

Col	1.204		
1			
UV04			
Col	1.205		
1			
UV03			
Col	1.206		
4			
UV14			
Col	1.207		
4			
UV03			
Col	1.208		
2			
UV03	CF3		LC10
Col	1.209		
1			
UV03			
Col	1.210		
4			
UV03			LC10
Col	1.211		
3			
UV03			
Col	1.212		
2			
UV11			
Col	1.213		
1			
UV06			
Col	1.214		
7			
UV04			
Col	1.215		
4			
UV14			
Col	1.216		
3			
UV03			
Col	1.217		
1			
UV03			LC10
Col	1.218		
1			
UV03			LC17
Col	1.219		
7			
UV03			LC10
Col	1.220		
8			
UV04			

Col	1.221		
2			
UV03		CF4	LC10
Col	1.222		
2			
UV03		CF3	LC10
Col	1.223		
2			
UV03			

Col 1	1.661			
UV04				
Col 2	1.662			
UV04			VC06	
Col 1	1.663			
UV03		CF3	VC06	
Col 1	1.664			
UV03				
Col 3	1.665			
UV04				
Col 1	1.666			
UV06				
Col 1	1.667			
UV03		CF3	LC10	
Col 2	1.668			
UV03		CF3	VC07	LC10
Col 1	1.669			
UV03		CF3	LC17	
Col 1	1.670			
UV03		CF3	LC10	
Col 1	1.671			
UV14				
Col 7	1.672			
UV03		CF3	LC10	
Col 3	1.673			
UV03				
Col 1	1.674			
UV03			LC10	
Col 3	1.675			
UV03		CF3	LC10	
Col 2	1.676			
UV14			VC07	LC10
Col 1	1.677			
UV01				

Col 3 UV03	1.678		
Col 1 UV03	1.679	CF4	
Col 1 UV03	1.680		LC17
Col 1 UV03	1.681	VC07	
Col 2 UV03	1.682	VC07	LC10
Col 3 UV14	1.683		
Col 1 UV03	1.684	CF4	LC17
Col 2 UV03	1.685		
Col 3 UV14	1.686	VC07	
Col 6 UV14	1.687		
Col 2 UV04	1.688		
Col 3 UV03	1.689		

Col 8	1.703		
UV11		VC10	
Col 2	1.704		
UV11		VC08	
Col 1	1.705		
UV11			
Col 1	1.706		
UV11		CF4	
Col 1	1.707		
UV11		CF4	VC08
Col 3	1.708		
UV11		CF4	
Col 1	1.709		
UV03		CF4	
Col 1	1.710		
UV11		CF4	VC08
Col 4	1.711		
UV11			
Col 1	1.712		
UV06			
Col 7	1.713		
UV04			
Col 1	1.715		
UV14			
Col 3	1.716		
UV03			
Col 1	1.717		
UV03			LC10
Col 1	1.718		
UV03			LC17
Col 7	1.719		
UV03			LC10
Col 8	1.720		
UV04			

Col	1.721		
6			
UV03		CF4	LC10

Col	1.675			
1				
UV04				
Col	1.676			
1				
UV03				
Col	1.677			
1				
UV03		CF4	VC07	LC10
Col	1.678			
2				
UV04			VC08	
Col	1.679			
1				
UV06			VC08	
Col	1.680			
1				
UV03				
Col	1.681			
1				
UV03		CF4		LC10
Col	1.682			
2				
UV03				
Col	1.683			
1				
UV06		CF4	VC07	LC10
Col	1.684			
1				
UV06		CF4		LC07
Col	1.685			
2				
UV03		CF4		LC10
Col	1.686			
1				
UV03		CF4	VC07	LC10
Col	1.687			
6				
UV03		CF4		LC10
Col	1.688			
1				
UV04				
Col	1.689			
1				
UV14			VC08	
Col	1.690			
1				
UV10				
Col	1.691			
5				
UV10		CF4		LC10

Col	1.692		
1			
UV11			
Col	1.693		
1			
UV06			
Col	1.694		
2			
UV11			
Col	1.695		
3			
UV03		CF4	
Col	1.696		
1			
UV10			
Col	1.697		
7			
UV03		CF4	LC10
Col	1.698		
1			
UV14		CF4	LC10
Col	1.699		
1			
UV05		CF4	LC10
Col	1.700		
1			
UV04		CF4	LC10
Col	1.701		
1			
UV04		CF4	
Col	1.702		
1			
UV03		CF4	
Col	1.703		
1			
UV04			
Col	1.704		
3			
UV03			
Col	1.705		
1			
UV03		CF4	
Col	1.706		
2			
UV04		CF4	
Col	1.707		
1			
UV04		CF4	VC08
Col	1.708		
1			
UV04		CF4	

Col	1.709
1	
UV03	CF4

Col	1.521		
1			
UV03			
Col	1.522		
1			
UV13			
Col	1.523		
1			
UV07			
Col	1.524		
3			
UV05			
Col	1.525		
2			
UV02			
Col	1.526		
2			
UV01			
Col	1.527		
1			
UV03			
Col	1.528		
5			
UV04			
Col	1.529		
1			
UV06			
Col	1.530		
4			
UV04		VC08	
Col	1.531		
1			
UV05		VC08	
Col	1.532		
2			
UV04		VC08	
Col	1.533		
6			
UV03			
Col	1.534		
1			
UV04			
Col	1.535		
2			
UV03			
Col	1.536		
2			
UV05			
Col	1.537		
18			
UV13			

Col	1.538	
1		
UV03		VC07
Col	1.539	
1		
UV03		LC17
Col	1.540	
2		
UV03		
Col	1.541	
2		
UV03		VC06
Col	1.542	
2		
UV03		

Col 5 UV03	1.495			AU06
Col 2 UV04	1.496			AU06
Col 2 UV04	1.497			
Col 1 UV02	1.498		LC17	AU01
Col 2 UV02	1.499			AU01
Col 2 UV04	1.500			
Col 1 UV03	1.501			
Col 2 UV04	1.502			
Col 1 UV03	1.503		LC01	
Col 4 UV03	1.504			AU07
Col 1 UV03	1.505			AU01
Col 1 UV04	1.506			AU01
Col 1 UV14	1.507			
Col 2 UV14	1.508		VC08	
Col 2 UV11	1.509		VC08	AU07
Col 1 UV11	1.510		VC08	
Col 1 UV11	1.511		VC08	AU01

Col	1.512		
1			
UV03			
Col	1.513		
1			
UV03		VC08	AU01
Col	1.514		
2			
UV11			AU06
Col	1.515		
4			
UV11		VC08	AU01
Col	1.516		
5			
UV11			AU01
Col	1.517		
4			
UV11		VC08	AU01
Col	1.518		
8			
UV11			AU01
Col	1.519		
1			
UV11			
Col	1.520		
3			
UV11		VC08	AU06

Col	1.621		
1			
UV02	US07		VC07
Col	1.622		
1			
UV02	US08		
Col	1.623		
2			
UV02	US02		
Col	1.624		
1			
UV02	US07		
Col	1.625		
2			
UV02	US10		VC05
Col	1.626		
1			
UV14	US02		
Col	1.627		
2			
UV02			LC16
Col	1.628		
1			
UV02	US02		
Col	1.629		
1			
UV02	US07		
Col	1.630		
1			
UV02	US02		
Col	1.631		
5			
UV02	US10		
Col	1.632		
1			
UV02			
Col	1.633		
5			
UV02			LC16
Col	1.634		
1			
UV10			
Col	1.635		
1			
UV02			
Col	1.636		
1			
UV02			AU09
Col	1.637		
2			
UV02			

Col	1.638		
5			
UV13			
Col	1.639		
1			
UV02	US06		VC07
Col	1.640		
1			
UV02	US10		
Col	1.641		
2			
UV02	US07		
Col	1.642		
1			
UV02	US09		
Col	1.643		
1			
UV02	VC05		
Col	1.644		
5			
UV02			
Col	1.645		
2			
UV03	US02		VC07
Col	1.646		
1			
UV02	US07		VC07
Col	1.647		
2			
UV02			
Col	1.648		
1			
UV02	US02		
Col	1.649		
1			
UV02	US09		
Col	1.650		
6			
UV02			
Col	1.651		
1			
UV02	US02		VC07
Col	1.652		
1			
UV02	US09		VC07

Col	1.579		
1			
UV06			
Col	1.580		
3			
UV02			
Col	1.581		
1			
UV03			
Col	1.582		
1			
UV15			
Col	1.583		
1			
UV03		CF3	VC07
Col	1.584		
2			
UV03			
Col	1.585		
1			
UV06			
Col	1.586		
11			
UV02			
Col	1.587		
2			
UV10			LC09
Col	1.588		
4			
UV14			
Col	1.589		
5			
UV02			
Col	1.590		
2			
UV03			
Col	1.591		
8			
UV02			
Col	1.592		
1			
UV02			VC07
Col	1.593		
17			
UV02			
Col	1.595		
3			
UV03			

Col	1.395		
1			
UV02	US02		
Col	1.396		
1			
UV06	US02		
Col	1.397		
1			
UV02	US02		
Col	1.398		
1			
UV03	US02		
Col	1.399		
2			
UV02	US02		
Col	1.400		
1			
UV03	US02		
Col	1.401		
1			
UV02			
Col	1.402		
1			
UV04			
Col	1.403		
1			
UV02			
Col	1.404		
1			
UV06		VC07	
Col	1.405		
1			
UV02		VC07	
Col	1.406		
1			
UV03			AU09
Col	1.407		
1			
UV02			AU09
Col	1.408		
1			
UV05			AU09
Col	1.409		
1			
UV04			AU06
Col	1.410		
1			
UV01			
Col	1.411		
1			
UV01			AU09

Col	1.412		
1			
UV02			AU09
Col	1.413		
1			
UV07	US13		
Col	1.414		
1			
UV02	US13		
Col	1.415		
1			
UV04	US13		
Col	1.416		
1			
UV04			
Col	1.417		
1			
UV04		VC08	
Col	1.418		
3			
UV04			
Col	1.419		
2			
UV02	US02		
Col	1.420		
7			
UV03	US02		
Col	1.421		
1			
UV02	US02		
Col	1.422		
1			
UV02	US13		
Col	1.423		
1			
UV02			
Col	1.424		
3			
UV04	US02		
Col	1.425		
3			
UV02	US13		
Col	1.426		
1			
UV05	US02		
Col	1.427		
3			
UV02	US02		
Col	1.428		
1			
UV03	US02		

Col	1.429		
2			
UV05			
Col	1.430		
1			
UV03			
Col	1.431		
4			
UV02	US13		
Col	1.432		
1			
UV03	US02		
Col	1.433		
1			
UV02			
Col	1.434		
1			
UV06			
Col	1.435		
1			
UV02			
Col	1.436		
1			
UV04		VC08	

Col	1.437			
1				
UV04		VC08	LC01	
Col	1.438			
1				
UV01		VC08		
Col	1.439			
1				
UV06		VC08		
Col	1.440			
2				
UV04			LC01	
Col	1.441			
1				
UV04				
Col	1.442			
3				
UV04			LC01	
Col	1.443			
1				
UV02			LC01	
Col	1.444			
1				
UV03		VC07	AU06	
Col	1.445			
2				
UV02	US13		AU06	
Col	1.446			
1				
UV06				
Col	1.447			
2				
UV02	US13			
Col	1.448			
1				
UV03		VC07	LC10	
Col	1.449			
2				
UV03			LC10	
Col	1.450			
1				
UV03			LC17	
Col	1.451			
1				
UV02			AU08	
Col	1.452			
1				
UV02			AU09	
Col	1.453			
1				
UV04				

Col	1.454		
1			
UV02			AU08
Col	1.455		
1			
UV04			AU08
Col	1.456		
1			
UV02			
Col	1.457		
1			
UV02	US05		
Col	1.458		
1			
UV02	US02		
Col	1.459		
1			
UV03	US02		
Col	1.460		
2			
UV03	US02	VC07	
Col	1.461		
1			
UV03	US02		
Col	1.462		
1			
UV02	US02		
Col	1.463		
4			
UV02	US02		AU07
Col	1.464		
1			
UV02	US02		
Col	1.465		
1			
UV02	US02		AU01
Col	1.466		
4			
UV02			
Col	1.467		
1			
UV03		LC17	
Col	1.468		
2			
UV03			
Col	1.469		
1			
UV02			
Col	1.470		
1			
UV02	US05		

Col 3	1.471			
UV02	US02			
Col 1	1.472			
UV02	US08			
Col 1	1.473			
UV02	US08			AU07
Col 1	1.474			
UV04	US02		VC08	
Col 1	1.475			
UV04			VC08	AU07
Col 1	1.476			
UV04				AU07
Col 1	1.477			
UV03				

Col 9 UV03	73			
Col 1 UV02	74			LC08
Col 1 UV03	75			LC08
Col 1 UV10	76			
Col 1 UV14	77	US06		LC01
Col 1 UV14	78	US06		LC01
Col 2 UV10	79			
Col 1 UV14	80	CF6	VC05	
Col 2 UV14	81	CF6		
Col 1 UV10	82	CF6		
Col 1 UV10	83			LC01
Col 1 UV10	84		VC07	LC01
Col 1 UV14	85		VC07	LC02
Col 1 UV14	86	CF6	VC05	
Col 1 UV14	87	CF6		
Col 9 UV03	88			
Col 1 UV07	89			VC08

Col	90		
1			
UV06		VC08	
Col	91		
1			
UV04		VC08	
Col	92		
7			
UV03			
Col	93		
1			
UV03		LC08	
Col	94		
3			
UV03			
Col	95		
3			
UV04			
Col	96		
3			
UV03			
Col	97		
1			
UV03		LC08	
Col	98		
4			
UV03			
Col	99		
1			
UV07			
Col	100		
1			
UV06			

Col 9 UV03	127			
Col 1 UV02	128			
Col 1 UV03	129			
Col 1 UV10	130			
Col 1 UV14	131			LC01
Col 2 UV10	133			
Col 4 UV14	134		CF6	
Col 1 UV10	138			LC01
Col 1 UV10	139		VC07	LC01
Col 1 UV14	140		VC07	LC02
Col 1 UV14	141		CF6	VC05
Col 1 UV14	142		CF6	
Col 9 UV03	143			
Col 1 UV07	144			VC08
Col 1 UV06	145			VC08
Col 1 UV07	146			VC08
Col 7 UV03	147			

Col	148
4	
UV03	
Col	149
3	
UV04	
Col	150
3	
UV03	
Col	151
5	
UV03	
Col	152
1	
UV07	
Col	153
1	
UV06	

Coo	372			
1				
UV02	US02		VC07	
Coo	373			
1				
UV02	US02			
Coo	374			
2				
UV02	US02		VC09	
Coo	375			
1				
UV02	US02		VC09	LC02
Coo	376			
1				
UV02	US02	CF4	VC09	
Coo	377			
1				
UV02	US02	CF3	VC09	
Coo	378			
3				
UV02	US02		VC09	
Coo	379			
1				
UV02	US02		VC07	
Coo	380			
6				
UV02	US02		VC09	
Coo	381			
9				
UV01	US02		VC09	LC09
Coo	382			
1				
UV03	US02		VC09	LC09
Coo	383			
1				
UV15	US02		VC09	LC09
Coo	384			
1				
UV06	US02		VC09	LC09
Coo	385			
1				
UV02			VC09	
Coo	386			
1				
UV03			VC09	
Coo	387			
1				
UV07			VC09	
Coo	388			
3				
UV02			VC09	

Coo 1	389		
UV03		VC09	AU04
Coo 3	390		
UV02		VC09	
Coo 3	391		
UV02		VC09	AU12
Coo 1	392		
UV03		VC09	AU12
Coo 4	393		
UV02		VC09	
Coo 5	394		
UV02		VC09	LC09
Coo 1	395		
UV03		VC09	
Coo 5	396		
UV02		VC09	
Coo 2	397		
UV01		VC09	AU06
Coo 2	398		
UV02			LC10

Coo	399				
1					
UV02	US02				
Coo	400				
1					
UV02	US08				
Coo	401				
2					
UV02	US08	VC07			
Coo	402				
6					
UV02	US08	VC07	LC09		
Coo	403				
1					
UV02					
Coo	404				
1					
UV02				AU06	
Coo	405				
5					
UV02		VC07		AU06	
Coo	406				
3					
UV03		VC07		AU06	
Coo	407				
2					
UV03		VC07		AU07	
Coo	408				
3					
UV03		VC07		AU06	
Coo	409				
1					
UV02				AU06	
Coo	410				
1					
UV06				AU06	
Coo	411				
1					
UV01		VC07	LC09	AU06	
Coo	412				
3					
UV02			LC09	AU06	
Coo	413				
1					
UV02		VC07	LC09		
Coo	414				
3					
UV02		VC09	LC09	AU06	
Coo	415				
4					
UV02		VC09		AU06	

Coo 1	416		
UV06		VC09	AU06
Coo 17	417		
UV02		VC09	AU06
Coo 1	418		
UV02		VC07	AU06
Coo 1	419		
UV02			AU06
Coo 1	420		
UV10			AU06

Coo 1	1.998		
UV02	US02		
Coo 1	1.999		
UV03	US02	VC07	
Coo 1	2.000		
UV03		VC07	
Coo 1	2.001		
UV03	US01	VC07	
Coo 1	2.002		
UV03	US02		LC10
Coo 1	2.003		
UV02	US08		
Coo 1	2.004		
UV06	US08		
Coo 1	2.005		
UV02	US02		
Coo 1	2.006		
UV06	US02		
Coo 1	2.007		
UV02	US02		
Coo 2	2.008		
UV02	US02	VC07	
Coo 1	2.009		
UV03	US02		
Coo 2	2.010		
UV03	US02	VC07	
Coo 1	2.011		
UV03	US01	VC07	
Coo 1	2.012		
UV02	US01	VC07	
Coo 1	2.013		
UV06	US01		
Coo 1	2.014		
UV02	US02		

Coo	2.015		
1			
UV08	US02		
Coo	2.016		
1			
UV02			
Coo	2.017		
1			
UV02	US01		LC10
Coo	2.018		
1			
UV02	US02		
Coo	2.019		
1			
UV03	US02		LC10
Coo	2.020		
1			
UV02	US05		
Coo	2.021		
2			
UV02	US02		
Coo	2.022		
1			
UV03	US06		VC07
Coo	2.023		
1			
UV03	US02		VC07
Coo	2.024		
1			
UV02	US02		
Coo	2.025		
15			
UV02	US13		
Coo	2.026		
1			
UV03	US02		
Coo	2.027		
3			
UV02	US13		VC07
Coo	2.028		
1			
UV02	US13		
Coo	2.029		
1			
UV03	US13		VC07
Coo	2.030		
1			
UV02	US13		
Coo	2.031		
1			
UV02	US13		VC07

Coo	2.032			
1				
UV02	US13	CF4	VC07	
Coo	2.033			
5				
UV02	US13			
Coo	2.034			
1				
UV03	US13			
Coo	2.035			
1				
UV03	US13		VC07	

Coo	1.979			
1				
UV02	US12			
Coo	1.980			
1				
UV02				
Coo	1.981			
2				
UV02	US13			
Coo	1.982			
2				
UV02				
Coo	1.983			
2				
UV02		VC07	LC10	
Coo	1.984			
1				
UV01	US01	VC07		
Coo	1.985			
2				
UV01				
Coo	1.986			
2				
UV13			LC10	
Coo	1.987			
1				
UV13	US05			
Coo	1.988			
1				
UV02	US08			
Coo	1.989			
2				
UV02	US07			
Coo	1.990			
27				
UV02	US13			
Coo	1.991			
1				
UV02	US08			
Coo	1.992			
1				
UV02	US06			
Coo	1.993			
2				
UV02	US13			
Coo	1.994			
1				
UV03				
Coo	1.995			
1				
UV03			LC03	

Coo	1.996		
1			
UV03		VC08	LC10
Coo	1.997		
9			
UV13			LC03

Coo	1.224		
4			
UV13			
Coo	1.225		
2			
UV03		VC07	
Coo	1.226		
1			
UV03			
Coo	1.227		
11			
UV13			
Coo	1.228		
11			
UV13			AU06
Coo	1.229		
2			
UV13			
Coo	1.230		
2			
UV13		VC07	
Coo	1.231		
1			
UV10		VC07	
Coo	1.232		
1			
UV10		VC07	LC17
Coo	1.233		
1			
UV10		VC07	
Coo	1.234		
1			
UV10			
Coo	1.235		
5			
UV13			
Coo	1.236		
12			
UV02	US02		
Coo	1.237		
1			
UV13	US13		
Coo	1.237		
3			
UV02	US02		
Coo	1.238		
1			
UV02	US02	VC09	
Coo	1.239		
1			
UV02	US02	VC07	

Coo	1.946			
1				
UV13	US02			
Coo	1.947			
1				
UV02	US02		LC17	
Coo	1.948			
1				
UV03	US02		LC17	
Coo	1.949			
1				
UV13	US02			
Coo	1.950			
1				
UV02	US02		LC17	
Coo	1.951			
5				
UV02	US02			
Coo	1.952			
2				
UV02	US02		VC07	
Coo	1.953			
12				
UV02	US02			
Coo	1.954			
1				
UV13	US13			
Coo	1.955			
3				
UV02	US02			
Coo	1.956			
1				
UV02	US02		VC09	
Coo	1.957			
1				
UV02	US02		VC07	
Coo	1.958			
1				
UV02	US02			
Coo	1.959			
1				
UV13	US02		LC17	AU11
Coo	1.960			
1				
UV02	US02		LC17	
Coo	1.961			
7				
UV02	US09			
Coo	1.962			
1				
UV02	US09		VC07	

Coo	1.963			
1				
UV02	US02		VC07	
Coo	1.964			
1				
UV03	US02		VC07	
Coo	1.965			
1				
UV02	US02			
Coo	1.966			
1				
UV06	US02			
Coo	1.967			
3				
UV02	US02			
Coo	1.968			
1				
UV03	US02		LC17	
Coo	1.969			
1				
UV03	US02		VC07	LC09
Coo	1.970			
1				
UV02	US02		VC07	
Coo	1.971			
1				
UV06	US02		VC07	
Coo	1.972			
1				
UV02	US02		VC07	
Coo	1.973			
1				
UV06	US02			
Coo	1.974			
2				
UV13	US03		VC01	
Coo	1.975			
1				
UV13	US08		VC09	
Coo	1.976			
1				
UV13	US08		VC07	
Coo	1.977			
1				
UV06	US08		VC07	
Coo	1.978			
1				
UV13	US08		VC07	

Coo	2.153		
7			
UV13		VC09	
Coo	2.154		
1			
UV13		VC07	
Coo	2.155		
4			
UV02		VC07	
Coo	2.156		
3			
UV02			
Coo	2.157		
7			
UV03			
Coo	2.158		
7			
UV13			
Coo	2.159		
3			
UV10		VC07	
Coo	2.160		
2			
UV02		VC07	
Coo	2.161		
1			
UV06		VC07	
Coo	2.162		
5			
UV02		VC07	
Coo	2.163		
4			
UV10		VC07	
Coo	2.164		
3			
UV02		VC07	
Coo	2.165		
1			
UV02		VC09	
Coo	2.166		
1			
UV01		VC09	LC17
Coo	2.167		
2			
UV10		VC09	LC17
Coo	2.168		
1			
UV13		VC09	
Coo	2.169		
1			
UV13			

Coo	2.170		
1			
UV02	US06		
Coo	2.171		
3			
UV02	US13		
Coo	2.172		
1			
UV02	US13	VC09	
Coo	2.173		
2			
UV02	US13		

Coo 1	2.084			
UV02	US13			
Coo 5	2.085			
UV02	US13	VC07		
Coo 1	2.086			
UV03	US02	VC07		
Coo 1	2.087			
UV10	US02	VC07		
Coo 1	2.088			
UV15	US02	VC07		
Coo 2	2.089			
UV02	US02	VC09		
Coo 2	2.090			
UV02	US13	VC07		
Coo 1	2.091			
UV02	US02	VC07		
Coo 1	2.092			
UV02	US02	VC09		
Coo 1	2.093			
UV02	US02	VC09	LC02	
Coo 1	2.094			
UV02	US02	VC09		
Coo 12	2.095			
UV02	US13	VC07		
Coo 1	2.096			
UV03	US02			
Coo 1	2.097			
UV03	US02	VC07		
Coo 3	2.098			
UV02	US02	VC09		
Coo 1	2.099			
UV02	US02	VC07	LC09	
Coo 1	2.100			
UV03	US02	VC07	LC09	

Coo	2.101			
1				
UV03	US02			LC09
Coo	2.102			
1				
UV03	US02			LC17
Coo	2.103			
3				
UV03	US02		VC07	
Coo	2.104			
1				
UV03	US02			
Coo	2.105			
1				
UV06	US02		VC07	LC17
Coo	2.106			
2				
UV02	US02		VC07	
Coo	2.107			
1				
UV06	US02		VC07	
Coo	2.108			
1				
UV02	US02		VC07	
Coo	2.109			
1				
UV06	US02		VC07	
Coo	2.110			
4				
UV02	US02		VC07	
Coo	2.111			
1				
UV06	US02		VC09	
Coo	2.112			
1				
UV06	US02		VC09	
Coo	2.113			
3				
UV02	US02		VC07	
Coo	2.114			
1				
UV06	US02		VC07	
Coo	2.115			
2				
UV02	US02		VC07	

Coo	274			
1				
UV05		CF1		LC01
Coo	275			
2				
UV05		CF1	VC09	LC01
Coo	276			
3				
UV05		CF3	VC07	LC01
Coo	277			
1				
UV10		CF3	VC07	
Coo	278			
1				
UV06		CF3	VC09	
Coo	279			
1				
UV10		CF3	VC09	
Coo	280			
1				
UV06		CF3	VC09	
Coo	281			
1				
UV10		CF3	VC09	
Coo	282			
1				
UV05		CF3	VC09	
Coo	283			
2				
UV05		CF3	VC07	
Coo	284			
5				
UV05		CF1	VC07	
Coo	285			
2				
UV05		CF1	VC09	
Coo	286			
2				
UV05		CF1	VC07	
Coo	287			
1				
UV05		CF1	VC10	
Coo	288			
4				
UV11		CF1	VC10	
Coo	289			
3				
UV11	US01	CF1	VC08	
Coo	290			
12				
UV11		CF1	VC10	

Coo	291			
2				
UV13		CF1	VC10	LC01
Coo	292			
5				
UV13		CF1		LC01
Coo	293			
2				
UV13		CF1		LC02
Coo	294			
1				
UV11		CF1	VC10	LC02
Coo	295			
3				
UV13		CF1	VC10	LC02
Coo	296			
4				
UV13		CF1	VC10	

Coo	306		
1			
UV01		CF1	LC01
Coo	307		
4			
UV05		CF3	LC01
Coo	308		
2			
UV03		CF1	VC09
Coo	309		
3			
UV10		CF1	VC09
Coo	310		
9			
UV03		CF1	VC09
Coo	311		
4			
UV10		CF1	VC07
Coo	312		
5			
UV10		CF1	VC09
Coo	313		
1			
UV04		CF1	VC10
Coo	314		
2			
UV11		CF1	VC10
Coo	315		
1			
UV04		CF1	VC10
Coo	316		
1			
UV04		CF1	VC09
Coo	317		
6			
UV03		CF1	VC09
Coo	318		
1			
UV03		CF1	VC10
Coo	319		
1			
UV04			VC10
Coo	320		
1			
UV03			VC10
Coo	321		
1			
UV04			VC10
Coo	322		
6			
UV03			VC10

Coo	323			
1				
UV03		CF1	VC10	
Coo	324			
6				
UV03		CF1	VC10	LC01
Coo	325			
4				
UV03		CF1	VC10	

Coo	326		
5			
UV16	US07		
Coo	327		
1			
UV15	US13		VC09
Coo	328		
3			
UV15	US13		
Coo	329		
1			
UV03	US03		
Coo	330		
4			
UV15	US13		
Coo	331		
4			
UV15	US13		VC07
Coo	332		
1			
UV10	US13		VC07
Coo	333		
4			
UV15	US13		
Coo	334		
1			
UV15	US13		VC09
Coo	335		
4			
UV15	US13		CF4
Coo	336		
1			
UV03	US13		CF4
Coo	337		
1			
UV15	US13		CF4
Coo	338		
2			
UV15	US13		VC09
Coo	339		
1			
UV17	US13		VC09
Coo	340		
1			
UV03	US13		VC09
Coo	341		
1			
UV03	US13		
Coo	342		
1			
UV17	US01		VC07

Coo	343		
1			
UV17	US02		VC07
Coo	344		
2			
UV17	US07		VC07
Coo	345		
1			
UV16	US13		
Coo	346		
4			
UV15	US13		
Coo	347		
1			
UV15	US03		VC09
Coo	348		
2			
UV10	US03		VC09
Coo	349		
1			
UV10			
Coo	350		
1			
UV15			
Coo	351		
7			
UV16			
Coo	352		
2			
UV10			VC09
Coo	353		
2			
UV16			VC09

Coo	558			
1				
UV03			LC16	
Coo	559			
4				
UV03				
Coo	560			
1				
UV15	US05			
Coo	561			
2				
UV15	US05		VC07	
Coo	562			
1				
UV15	US04		VC07	
Coo	563			
1				
UV15	US02		VC06	
Coo	564			
4				
UV15	US13			
Coo	565			
1				
UV03	US13			
Coo	566			
3				
UV15	US13			
Coo	567			
2				
UV10	US13		VC09	
Coo	568			
2				
UV15	US13		VC09	
Coo	569			
2				
UV15				
Coo	570			
1				
UV15			VC07	
Coo	571			
1				
UV02	US05		VC07	LC02
Coo	572			
1				
UV15	US13			
Coo	573			
2				
UV15	US13			LC02
Coo	574			
1				
UV15	US13			

Coo	575		
1			
UV15	US13	CF4	
Coo	576		
1			
UV15	US06		VC07
Coo	577		
4			
UV15	US13		VC07
Coo	578		
3			
UV15	US13		VC09
Coo	579		
1			
UV10	US13		VC09
Coo	580		
1			
UV10	US13		VC07
Coo	581		
4			
UV15	US13		
Coo	582		
1			
UV15	US13		VC07
Coo	583		
1			
UV10	US13		VC07
Coo	584		
5			
UV15	US13		
Coo	585		
1			
UV10	US13		
Coo	586		
4			
UV15	US13		
Coo	587		
1			
UV15	US13		VC09
Coo	588		
1			
UV10	US13		VC09
Coo	589		
1			
UV15	US13		VC07
Coo	590		
1			
UV10	US13		VC07

Coo	2.036			
1				
UV01		CF1		
Coo	2.037			
1				
UV01		CF1	LC01	
Coo	2.038			
1				
UV03		CF1	LC01	
Coo	2.039			
2				
UV04		CF1	LC14	
Coo	2.040			
2				
UV04		CF1		
Coo	2.041			
4				
UV03		CF1		
Coo	2.042			
3				
UV03		CF1	VC09	
Coo	2.043			
1				
UV04		CF1		
Coo	2.044			
5				
UV03		CF1		
Coo	2.045			
3				
UV02		CF1		
Coo	2.046			
1				
UV02		CF1	VC09	
Coo	2.047			
1				
UV03		CF1	VC09	LC01
Coo	2.048			
5				
UV13		CF1	LC01	
Coo	2.049			
2				
UV13		CF1	VC09	LC01
Coo	2.050			
9				
UV13		CF1	LC01	
Coo	2.051			
3				
UV03		CF1	LC01	
Coo	2.052			
1				
UV01		CF1		

Coo	2.053		
1			
UV03		CF1	
Coo	2.054		
5			
UV13		CF1	
Coo	2.055		
5			
UV03		CF1	
Coo	2.056		
4			
UV01		CF1	

Coo	2.058			
4				
UV13		CF1		
Coo	2.059			
1				
UV03		CF1	VC07	LC16
Coo	2.060			
1				
UV03		CF1	VC07	
Coo	2.061			
1				
UV03		CF1		LC16
Coo	2.062			
1				
UV03		CF1	VC10	LC16
Coo	2.063			
6				
UV03		CF1	VC10	
Coo	2.064			
6				
UV13		CF1		
Coo	2.065			
1				
UV13		CF1	VC09	LC01
Coo	2.066			
17				
UV13		CF1		LC01
Coo	2.067			
2				
UV03		CF1		LC01
Coo	2.068			
1				
UV09		CF1		
Coo	2.069			
1				
UV01		CF1		
Coo	2.070			
3				
UV03		CF1		
Coo	2.071			
1				
UV07		CF1		
Coo	2.072			
2				
UV03		CF1		
Coo	2.073			
5				
UV05		CF1		
Coo	2.074			
3				
UV03		CF1	VC07	

Coo	2.075		
1			
UV03			LC16
Coo	2.076		
1			
UV03		VC09	
Coo	2.077		
1			
UV03		VC07	LC16
Coo	2.078		
1			
UV03		VC07	

Coo	1.236		
2			
UV10		CF4	AU06
Coo	1.237		
1			
UV10		CF4	
Coo	1.238		
2			
UV14		CF4	
Coo	1.239		
1			
UV04		CF4	
Coo	1.240		
1			
UV05		CF4	
Coo	1.241		
1			
UV07			
Coo	1.242		
1			
UV03			
Coo	1.243		
3			
UV04			
Coo	1.244		
2			
UV04			AU06
Coo	1.245		
1			
UV14			AU06
Coo	1.246		
1			
UV06			AU06
Coo	1.247		
1			
UV14			AU06
Coo	1.248		
1			
UV04			AU06
Coo	1.249		
1			
UV03			AU06
Coo	1.250		
1			
UV04			AU06
Coo	1.251		
1			
UV06			
Coo	1.252		
1			
UV14			

Coo	1.253			
2				
UV14		CF3		LC09
Coo	1.254			
1				
UV04		CF3		
Coo	1.255			
1				
UV14		CF3		
Coo	1.256			
1				
UV04			VC08	LC01
Coo	1.257			
1				
UV04			VC08	
Coo	1.258			
2				
UV04				
Coo	1.259			
1				
UV14				
Coo	1.260			
3				
UV09			VC08	
Coo	1.261			
1				
UV09			VC08	LC01
Coo	1.262			
4				
UV09				
Coo	1.263			
1				
UV09			VC08	
Coo	1.264			
1				
UV11				
Coo	1.265			
1				
UV04				
Coo	1.266			
1				
UV14			VC05	LC01
Coo	1.267			
1				
UV14				LC11
Coo	1.268			
1				
UV04				LC11 AU12
Coo	1.269			
1				
UV04				AU12

Coo	1.270			
1				
UV05				
Coo	1.271			
1				
UV03		CF3	VC06	
Coo	1.272			
2				
UV05				AU11
Coo	1.273			
1				
UV02	US06		VC05	LC07
Coo	1.274			
1				
UV02	US07			LC13
Coo	1.275			
1				
UV02	US06			LC13
Coo	1.276			
1				
UV02	US07			LC13
Coo	1.277			
1				
UV05				LC15
Coo	1.278			
2				
UV05				
Coo	1.279			
2				
UV13				

Coo	1.280		
3			
UV02		CF4	
Coo	1.281		
1			
UV01		CF4	
Coo	1.282		
1			
UV06		CF4	VC09
Coo	1.283		
1			
UV01		CF4	
Coo	1.284		
1			
UV06		CF4	VC09
Coo	1.285		
1			
UV02		CF4	
Coo	1.286		
1			
UV06		CF4	
Coo	1.287		
1			
UV02		CF4	VC07
Coo	1.288		
10			
UV02		CF4	
Coo	1.289		
1			
UV06		CF3	LC11
Coo	1.290		
1			
UV15		CF4	
Coo	1.291		
1			
UV06		CF4	
Coo	1.292		
4			
UV02		CF4	
Coo	1.293		
7			
UV02			
Coo	1.294		
2			
UV06		CF6	
Coo	1.295		
4			
UV02			
Coo	1.296		
1			
UV07			

Coo	1.297		
1			
UV02			
Coo	1.298		
1			
UV06			
Coo	1.299		
2			
UV02		CF4	
Coo	1.300		
2			
UV03		CF4	
Coo	1.301		
2			
UV02		CF4	
Coo	1.302		
1			
UV02	US06	CF4	
Coo	1.303		
1			
UV06	US02	CF4	
Coo	1.304		
2			
UV06		CF4	
Coo	1.305		
2			
UV02		CF4	
Coo	1.306		
5			
UV14			

10.2.- Dades relatives a les sessions d'observació agrupades segons el tipus d'organització social de les situacions.

```

*****
* TEST DADES PER ASR *
* TIPUS 3. DURACIONS ACUMULADES. 2 SISTEMES, 9 SESSIONS *
* 10 SUBSISTEMES: UV, VC, CF, US, LC; CONDUCTES *
* CATEGORIES NEN A *
* UV = { UV00, UV01, UV02, UV03, UV04, ....., UV17 } *
* VC = { VC01, VC02, VC03, VC04, VC05, ....., VC12 } *
* CF = { CF1, CF2, CF3, CF4, CF5, CF6, CF7 } *
* US = { US01, US02, US03, US04, US05, US06, ....., US15 } *
* LC = { LC01, LC02, LC03, LC04, LC05, LC06, ....., LC18 } *
* CATEGORIES NEN B *
* VU = { VU00, VU01, VU02, VU03, VU04, ....., VU17 } *
* CV = { CV01, CV02, CV03, CV04, CV05, ....., CV12 } *
* FC = { FC1, FC2, FC3, FC4, FC5, FC6, FC7 } *
* SU = { SU01, SU02, SU03, SU04, SU05, SU06, ....., SU15 } *
* CL = { CL01, CL02, CL03, CL04, CL05, CL06, ....., CL18 } *
*****

```

```

$
310001
0009
INDIVIDUAL          ACTIVITAT: DIBUIX JARDINERS:
$UV                SESSIO 1
00
UV02UV03UV02UV03UV02UV12UV02UV03UV02UV06UV02UV06UV12UV10UV02/
 6  8 10 12 16 23 24 26 32 33 42 43 50 54 60
$VC
00
VC12VC10VC12VC07VC12VC07VC09VC12VC05VC12/
12 14 26 27 47 50 53 58 59 60
$CF
00
CF07CF03CF07/
 44 51 60
$US
00
US13US02US13US02US13US02US13US02US13US02US13US02US13US02/
 3  8 10 11 16 27 35 36 38 42 47 53 58 60
$LC
00
LC18LC10LC18LC10LC18/
 21 23 47 49 60
$VU                SESSIO 1
00
VU02VU03VU02VU03VU02VU13VU02VU03VU02VU06VU02VU06VU13VU11VU02/
 6  8 10 12 16 23 24 26 32 33 43 44 50 54 60
$CV
00
CV12CV10CV12CV07CV12CV07CV09CV12CV05CV12/
12 14 26 28 47 50 53 58 59 60
$FC
00
FC07FC03FC07/
 44 50 60
$SU
00
SU06SU13SU02SU07SU02SU13SU07SU06SU13SU02SU07SU02SU13/
 1  2  4  5 28 35 36 37 40 42 43 57 60
$CL
00
CL18CL10CL18CL10CL18/
18 21 43 50 60
INDIVIDUAL          ACTIVITAT: FANG .
$UV                SESSIO 2
00
UV02UV03UV02UV10UV03UV10UV03UV10UV11UV03UV02UV03UV10UV12/
 4  5 21 22 23 24 26 28 31 35 40 41 57 60
$VC
00
VC12VC07VC08VC12VC07VC12/

```

21 26 31 40 43 60

\$CF
00
CF07/
60
\$US
00
US09US02US09US15US09/
35 36 51 56 60

\$LC
00
LC18LC01LC18/
51 55 60

\$VU
00
SESSIO 2

VU02VU03VU02VU10VU03VU15VU10VU02VU06VU02VU06VU15VU02VU03VU02VU14VU02VU03
8 11 15 17 21 22 23 25 26 28 29 31 33 35 40 43 49 51
VU14VU06VU14VU02VU13VU10/
52 53 54 57 58 60

\$CV
00
CV12CV07CV12CV07CV12CV07CV12CV07CV12CV07CV12/
8 17 19 20 35 37 38 39 58 59 60

\$EC
00
EC07/
60
\$SU
00
SU09SU02SU09SU02SU15/
39 43 49 57 60

\$CL
00
CL18CL17CL18/
20 21 60

INDIVIDUAL ACTIVITAT: EXPRESSIO PLASTICA.

\$UV
00
SESSIO 3

UV03UV06UV03UV02UV04UV03UV02UV01UV07UV02UV10UV06UV02UV03UV11UV03/
6 7 15 17 20 22 23 25 26 34 35 36 43 45 52 60

\$VC
00
VC07VC12/
3 60

\$CF
00
CF07/
60
\$US
00
US15US05US13US15US13US15US05US08US02US15US08US06US15US05US15/
23 26 33 39 41 46 47 48 50 51 52 53 54 55 60

\$LC
00
LC18LC17LC18/
11 12 60

\$VU
00
SESSIO 3

VU02VU06VU02VU15VU02/
7 9 17 56 60

\$CV
00
CV12CV07CV12CV06CV12/
8 11 17 19 60

\$EC
00
EC07/
60
\$SU
00

SU15SU13SU05SU15SU13SU15SU02SU12SU02SU12SU02SU13SU06SU15SU05SU13SU06SU13
1 4 5 6 7 9 11 12 15 19 20 22 24 29 34 38 39 42
SU12SU13SU12SU15SU13SU15SU12SU15/
44 46 51 52 56 57 59 60

\$CL
00
CL18CL17CL18/
8 9 60

ACTIVITAT: DIBUIX SOBRE TEXT.
SESSIO 4

\$UV
00
UV02UV04UV02UV01UV04UV07UV02UV03UV02UV06UV02/
4 7 21 22 25 26 29 31 38 39 60

\$VC
00
VCL2/
00

\$CF
00
CF07/
00

\$US
00
US02US13US02US13US02US15US06US05US02US13US02US13US02US13/
1 4 9 13 16 17 19 21 32 35 36 38 39 60

\$IC
00
IC18/
00

\$VU
00
SESSIO 4

VU02VU03VU02VU01VU04VU02VU03VU02VU06VU02VU03VU02VU06VU02/
2 5 19 20 25 31 33 41 42 44 45 49 50 60

\$CV
00
CV12CV07CV12CV07CV12CV07CV12CV07CV12/
33 34 41 42 44 45 48 49 60

\$FC
00
FC07/
00

\$SU
00
SU02SU13SU02SU13SU05SU02SU13SU02SU05SU13SU06SU02SU13SU02SU13SU05SU15SU02
1 2 5 15 19 25 31 34 38 40 42 43 44 45 48 49 50 51
SU13SU06SU05SU02SU13/
52 54 56 57 60

\$CL
00
CL18CL17CL18/
4 5 60

INDIVIDUAL
\$UV
00
ACTIVITAT: DIBUIX TEXTE.
SESSIO 5

UV02UV10UV02UV06UV02UV06UV02UV03UV02UV11/
7 13 39 40 41 42 43 44 56 60

\$VC
00
VCL2VC07VCL2VC07VCL2VC07VC05VCL2VC08/
7 11 18 22 34 36 37 56 60

\$CF
00
CF07CF03CF04CF07/
41 42 43 60

\$US
00
US01US02US13US05US02US13US06US13US02US13US15US02US15/
1 2 8 9 13 16 17 34 36 40 44 46 60

\$IC
00

LC18LC10LC18/

7 8 60

SESSIO 5

\$WU

00

VU03VU02VU03VU13VU02VU06VU02VU06VU10VU02VU03VU08VU06VU02VU06VU02/

2 3 4 5 6 7 14 15 20 26 30 31 32 36 37 60

\$CV

00

CV12CV07CV12CV07CV12CV07CV12CV07CV12/

4 5 13 20 39 40 44 46 60

\$FC

00

FC07FC04/

59 60

\$SU

00

SU02SU05SU02SU03SU02SU13SU15SU02SU13SU02SU13/

1 2 3 4 5 14 15 20 26 37 60

\$CL

00

CL18/

60

INDIVIDUAL

ACTIVITAT:COPIA D'UN TEXT.

\$UV

SESSIO 6

00

UV02UV09UV02UV09UV03UV05UV03UV02UV07UV02UV07UV02/

1 2 3 4 28 39 44 47 48 51 52 60

\$VC

00

VC12/

60

\$CF

00

CF07/

60

\$US

00

US02US15US02US15/

28 39 44 60

\$LC

00

LC18LC17LC18LC17LC18LC17LC18LC17LC18LC17LC18LC17LC18/

8 9 12 13 14 15 17 18 21 22 23 24 26 27 60

\$VU

SESSIO 6

00

VU02VU03VU02VU03VU02VU03VU06VU02VU04/

4 6 8 11 22 28 29 42 60

\$CV

00

CV12CV05CV12CV05CV12/

33 34 42 44 60

\$FC

00

FC07/

60

\$SU

00

SU02SU15SU08SU02SU04SU06SU02SU15SU02/

8 11 19 34 35 36 42 43 60

\$CL

00

CL18CL17CL18CL17CL18/

23 24 33 34 60

INDIVIDUAL

ACTIVITAT: COPIAR UN TEXT.

\$UV

SESSIO 7

00

UV02UV03UV02UV13UV02UV03UV02UV10UV02UV10UV02UV13UV02UV13UV02UV14UV03/

3 4 12 13 19 21 24 25 28 30 34 35 40 42 47 49 60

\$VC

00

VC12VC07VC12VC07VC12/
19 20 39 40 60

SCF
00
CF07CF03CF07CF03CF07/
37 38 39 40 60

SUS
00
US02US13US02US13US02US13US02US13US02US13US02/
1 3 4 12 13 19 21 25 43 47 60

SLC
00
LC18LC17LC18LC10LC18LC17LC18/
19 20 37 38 51 52 60

SVU
00
SVU
SESSIO 7
00
VU02VU01VU03VU02VU03VU10VU02VU13VU03VU01/
2 5 9 22 23 29 36 50 55 60

SCV
00
CV12CV07CV12/
24 27 60

SFC
00
FC07FC04FC07/
2 4 60

SSU
00
SU02SU13SU02SU13SU02SU13SU02/
1 2 11 22 32 36 60

SCL
00
CL18/
60
INDIVIDUAL ACTIVITAT: PINTAR PECES FANG.
\$UV SESSIO 8
00

UV02UV03UV06UV03UV14UV06UV02UV10UV01UV03UV02UV03UV17UV01UV02UV04UV02/
9 10 11 12 13 14 15 16 28 31 34 37 44 48 56 57 60

VC12VC07VC12VC07VC12/
16 35 43 50 60

SCF
00
CF07/
60
SUS
00
US13US02US09US13US09US13US02US07US15US06US09US14US02US13/
1 4 5 11 14 17 32 35 47 49 50 56 59 60

SLC
00
LC18LC01LC18LC01LC18/
30 34 42 48 60
SVU
00
SESSIO 8

VU02VU03VU02VU10VU03VU10VU03VU10VU11VU03VU02VU03VU10VU13/
4 5 21 22 23 24 26 28 31 35 40 41 57 60

SCV
00
CV12CV09CV07CV08CV12CV07CV12/
21 22 26 31 40 43 60

SFC
00
FC07/
60
SSU
00
SU09SU02SU09SU15SU09/
00

35 36 51 56 60

\$CL
00
CL18CL01CL18/
51 56 60

INDIVIDUAL ACTIVITAT: BIBLIOTECA.
\$UV SESSIO 9

00
UV15UV06UV15UV03UV15UV03UV15UV03UV15/
8 9 17 19 22 26 27 32 60

\$VC
00
VC05VC06VC07VC09VC07VC12VC05/
14 18 20 24 29 37 60

\$CF
00
CF07/
00

\$US
00
US15US13US07US10US15US13/
6 14 20 24 26 60

\$IC
00
IC18/
00

\$VU SESSIO 9
00
VU03VU13VU03VU13VU10VU13VU02VU10VU02VU13VU03VU13/
2 17 20 21 22 24 26 31 32 44 45 60

\$CV
00
CV12CV07CV09CV07CV12CV09CV07CV09CV12/
19 21 22 23 24 25 26 30 60

\$FC
00
FC07/
00

\$SU
00
SU13SU07SU13SU07SU13SU05SU13/
17 21 23 32 55 56 60

\$CL
00
CL18CL16CL18CL16CL18CL16CL18/
23 24 30 31 55 56 60

INDIVIDUAL ACTIVITAT: PINTAR EL DIBUIX.
\$UV SESSIO 10

00
UV02UV12UV03UV02UV12UV03UV12UV03UV02UV03UV02UV03UV15UV03UV02UV12UV10/
3 8 11 17 19 20 25 26 35 36 37 38 39 42 47 51 60

\$VC
00
VC12VC07VC12VC07VC12VC07VC12VC07VC12VC07VC12VC07VC12/
21 24 26 28 30 33 37 38 39 41 47 48 60

\$CF
00
CF07/
00

\$US
00
US13US02US13US02US13US02US13US02US13US02US13US02/
3 8 10 11 16 26 34 35 37 41 46 60

\$IC
00
IC18IC02IC18IC02IC18/
20 22 46 47 60

\$VU SESSIO 10
00
VU02VU13VU09VU06VU12VU03VU08VU02VU13/
3 8 11 17 19 20 25 26 35 36 37 38 39 42 47 51 60

36 38 41 42 46 49 50 57 60

\$CV
00
CV12/
@
\$FC
00
FC07/
@
\$SU
00
SU02SU13SU02/
2 15 60

\$CL
00
CL18/
@

INDIVIDUAL ACTIVITAT: INTERSECCIO LINEES.
\$UV SESSIO 11

00
UV16UV15UV16UV10UV15UV16UV15UV16UV06UV15UV03/
1 2 3 6 7 9 15 19 20 57 60

\$VC
00
VC07VC09VC07VC09VC12VC07/
4 9 15 19 58 60

\$CF
00
CF07/
@

\$US
00
US13US07US13US07US01/
6 9 57 59 60

\$LC
00
LC18/
@

\$VU SESSIO 11
00

VU15VU03VU15VU09VU03VU15VU07VU15VU13VU15VU06VU15/
1 2 3 4 7 39 40 49 53 54 55 60

\$CV
00
CV09CV07CV09CV07CV12/
3 7 8 10 60

\$FC
00
FC07/
@

\$SU
00
SU07SU13SU06SU05SU08SU13/
5 48 49 50 53 60

\$CL
00
CL18/
@

```

*****
* TEST DADES PER ASR      COL.LECTIVES      *
* TIPUS 3. DURACIONS ACUMULADES. 2 SISTEMES, 9 SESSIONS      *
* 10 SUBSISTEMES: UV, VC, CF, US, LC; CONDUCTES      *
* CATEGORIES NEN A      *
* UV = { UV00, UV01, UV02, UV03, UV04, ....., UV17 }      *
* VC = { VC01, VC02, VC03, VC04, VC05, ....., VC12 }      *
* CF = { CF1, CF2, CF3, CF4, CF5, CF6, CF7 }      *
* US = { US01, US02, US03, US04, US05, US06, ....., US15 }      *
* LC = { LC01, LC02, LC03, LC04, LC05, LC06, ....., LC18 }      *
* CATEGORIES NEN B      *
* VU = { VU00, VU01, VU02, VU03, VU04, ....., VU17 }      *
* CV = { CV01, CV02, CV03, CV04, CV05, ....., CV12 }      *
* FC = { FC1, FC2, FC3, FC4, FC5, FC6, FC7 }      *
* SU = { SU01, SU02, SU03, SU04, SU05, SU06, ....., SU15 }      *
* CL = { CL01, CL02, CL03, CL04, CL05, CL06, ....., CL18 }      *
*****

```

```

$
310001
0011
          ACTIVITAT: ESTABLIR RELACIONS.
$UV
00
          SESSIO 1
UV10UV03UV06UV07UV11UV01UV03UV04UV06UV03UV06UV04UV06UV04UV06UV04UV03UV04
  1  2  3  4  5  6  8  9 11 12 15 16 17 18 19 20 21 26
UV07UV06UV03UV04UV03UV07UV06UV04UV03UV02UV06UV02UV06UV02UV06UV02UV04/
 30 31 32 33 36 37 38 39 41 42 44 48 49 51 52 54 60

```

```

$VC
00
VC12VC10VC12VC10VC12VC07VC12/
 13 14 20 21 48 49 60
$CF
00
CF07CF03CF07/
 13 14 60
$US
00
US02US15US02US15US01US02US08US02/
 13 14 18 19 20 39 40 60

```

```

$LC
00
LC18LC11LC10LC09LC11LC18/
 12 14 20 34 37 60
$VU
00
          SESSIO 1
VU03VU04VU03VU12VU02VU06VU15VU11VU02VU06VU07VU02VU06VU02VU03VU06VU07VU03
  2  5  8 11 14 15 16 18 28 29 30 35 36 37 40 41 42 47
VU10VU03VU04VU15VU04VU02VU04VU03/
 50 51 52 53 54 55 57 60

```

```

$CV
00
CV12CV08CV12CV08CV12CV06CV12CV08CV12CV08CV12/
  7  9 14 18 30 31 41 42 55 56 60
$FC
00
FC07FC06FC07FC06FC07FC06FC07/
 46 47 48 52 54 56 60

```

```

$SU
00
SU02SU15SU02SU15/
 34 42 43 60
$CL
00
CL18CL10CL18CL10CL18/
  6  8 45 50 60

```

```

$UV
00
          ACTIVITAT: ESTABLIR RELACIONS.
          SESSIO 2
UV15UV06UV07UV03UV02UV03UV07UV15UV04UV06UV04UV06UV01UV06UV01UV06UV04UV02

```

1 2 3 6 9 10 11 12 15 21 23 28 30 31 36 37 44 48

UV06UV15UV06UV07UV03/

49 50 51 55 60

\$VC

00

VC12VC08VC12VC07VC12/

36 38 44 45 60

\$CF

00

CF07/

60

\$US

00

US02US01US02US04US02/

36 38 39 43 60

\$LC

00

LC18LC17LC18LC17LC18LC01LC18LC01LC18/

16 18 19 20 33 34 42 44 60

\$VU

SESSIO 2

00

VU11VU09VU13VU11VU10VU11VU15VU02VU11VU14VU11VU03VU11VU03VU13VU06VU13VU03

2 3 4 5 6 7 8 10 11 12 15 20 22 25 26 27 28 29

VU07VU03VU02VU03VU02/

30 31 37 46 60

\$CV

00

CV12CV05CV12CV08CV12CV08CV12CV07CV12CV05CV12CV06CV12CV06CV12/

10 11 16 17 19 21 25 26 29 30 31 33 38 39 60

\$FC

00

FC07/

60

\$SU

00

SU15SU07SU12SU02SU04SU03SU15SU02SU08SU02SU08SU02/

8 9 10 18 19 20 21 32 35 36 37 60

\$CL

00

CL18CL10CL18CL01CL18CL09CL10CL18CL10CL18CL17CL18/

4 5 14 15 17 19 20 22 24 42 43 60

ACTIVITAT: REPRESENTACIO JARDINERS.

\$UV

SESSIO 3

00

UV10UV03UV06UV01UV13UV10UV03UV02UV03UV01UV03UV02UV14UV02UV03UV01UV03UV02

5 8 9 10 11 12 17 18 21 23 24 25 26 27 28 29 31 32

UV10UV05UV04UV03UV04UV05UV04/

33 43 45 48 49 58 60

\$XC

00

VC12VC06VC12/

48 49 60

\$CF

00

CF07/

60

\$US

00

US15/

60

\$LC

00

LC18LC16LC18/

13 14 60

\$VU

SESSIO 3

00

VU06VU10VU14VU10VU14VU10VU14VU03VU07VU06VU07VU03VU02VU03VU07VU06/

11 12 14 16 19 22 25 34 35 36 37 47 50 53 58 60

\$CV

00

CV12CV05CV12CV07CV05CV12CV08CV12/
16 17 21 23 24 34 36 60

\$FC
00

FC07FC05FC07FC06FC07/
16 20 23 25 60

\$SU
00

SU15SU07SU06SU15/
12 13 14 60

\$CL
00

CL18CL16CL18CL01CL18CL01CL10CL18CL16CL18CL16CL18/
9 11 12 14 20 22 23 42 43 52 53 60

ACTIVITAT: REPRESENTACIO JARDINERS.
SESSIO 4

\$UV
00

UV02UV10UV14UV05UV14UV03UV10UV05UV10UV14UV07UV03UV04UV14UV04/
3 8 9 14 15 16 20 24 43 44 45 54 55 57 60

\$VC
00

VC12VC07VC12VC07VC12VC07VC12VC07VC12VC07VC12VC07VC12VC07VC12VC07VC12/
3 8 9 14 18 22 26 27 28 30 34 39 41 43 50 51 60

\$CF
00

CF07/
00

\$US
00

US15US01US15US01US15/
10 13 34 35 60

\$LC
00

LC18LC10LC18LC10LC18LC10LC18LC10LC18LC10LC18/
3 8 9 13 14 17 20 23 27 32 60

\$WU
00
SESSIO 4

WU04WU03WU06WU03WU10WU02WU03WU10WU03WU05WU01WU03WU14WU10WU09WU03WU10WU05
1 5 6 10 11 12 13 14 15 17 19 23 24 32 33 43 46 54

WU04/
00

\$CV
00

CV12CV06CV12CV07CV06CV12CV08/
24 38 43 46 54 55 60

\$FC
00

FC04FC07FC04FC07FC04FC07/
1 10 11 20 23 60

\$SU
00

SU15/
00

\$CL
00

CL18CL10CL18CL10CL18CL10CL18/
3 9 14 15 20 24 60

ACTIVITAT: REPRESENTACIO AUTOCAR.
SESSIO 5

\$UV
00

UV04UV03UV14UV03UV11UV06UV04UV14UV03UV04UV03/
1 2 6 20 22 23 30 34 46 54 60

\$VC
00

VC12/
00

\$CF
00

CF07CF03CF07CF04CF03CF07/
10 12 54 56 58 60

SUS
 00
 US15/
 00
 \$LC
 00
 LC18LC10LC18LC10LC18LC10LC17LC10LC18LC10LC18/
 10 12 13 17 37 38 39 46 54 56 60
 \$VU
 SESSIO 5
 00
 VU04VU03VU04VU06VU03VU14VU03VU14VU01VU03VU14VU03VU14VU03/
 3 4 5 8 9 14 15 29 31 40 43 46 57 60

\$CV
 00
 CV12CV06CV12CV07CV12CV07CV12CV07CV12CV07CV12/
 1 4 10 12 29 31 37 40 46 49 60
 \$FC
 00
 FC07FC03FC07FC03FC07FC03FC07FC03FC07FC04FC07FC04FC07/
 4 9 14 15 22 26 29 35 36 43 44 49 60

\$SU
 00
 SU15/
 00
 \$CL
 00
 CL18CL10CL17CL10CL18CL10CL18CL10CL18CL17CL18CL10CL18CL17CL18/
 9 12 13 14 15 22 25 26 36 37 38 40 43 44 60
 ACTIVITAT: REPRESENTACIO AUTOCAR.
 \$UV
 SESSIO 6
 00

UV11UV03UV11UV06UV04UV14UV03UV04UV03/
 16 17 22 23 30 31 43 51 60
 \$VC
 00
 VC10VC08VC12VC08VC12VC08VC12/
 8 10 12 13 17 18 60

\$CF
 00
 CF07CF04CF07/
 11 18 60

\$US
 00
 US16/
 00
 \$LC
 00
 LC18LC10LC17LC10LC18LC10/
 34 35 36 43 51 60

\$VU
 SESSIO 6
 00
 VU04VU03VU04VU06VU03VU06VU03VU04VU14VU10VU11VU06VU11VU03VU10VU03VU14VU05
 1 3 5 6 10 12 21 22 23 29 30 31 33 36 37 44 45 46
 VU04VU03VU04VU03VU04VU03/
 48 49 50 54 58 60

\$CV
 00
 CV12CV07CV08CV12CV07CV12CV07CV12CV08CV12CV08CV12/
 2 3 6 10 11 14 15 22 23 56 57 60

\$FC
 00
 FC07FC04FC07FC04FC07FC04FC07FC04FC07FC04FC07FC04FC07FC04/
 2 3 7 8 10 21 24 29 33 36 37 49 53 60

\$SU
 00
 SU15/
 00
 \$CL
 00
 CL18CL10CL18CL10CL18CL10CL07CL10CL18CL10CL18CL10CL18/
 9 12 13 14 15 22 25 26 36 37 38 40 43 44 60

2 3 7 8 10 11 12 21 24 29 37 47 60

ACTIVITAT: NARRACIO CONTE.

SESSIO 7

\$UV

00

UV03UV13UV07UV05UV02UV01UV03UV04UV06UV04UV05UV04UV03UV04UV03UV05UV13UV03

1 2 3 6 8 10 11 16 17 21 22 24 30 31 33 35 53 60

/

\$VC

00

VC12VC08VC12VC07VC12VC06VC12/

17 24 53 54 57 58 60

\$CF

00

CF07/

00

\$US

00

US15/

00

\$LC

00

LC18LC17LC18/

54 55 60

\$VU

SESSIO 7

00

VU03VU04VU02VU04VU03VU04VU03VU04VU14VU11VU03VU11/

5 9 12 14 15 17 23 24 27 3132 60

\$CV

00

CV12CV08CV12CV08CV12CV08CV12CV08CV12CV08/

25 31 32 33 35 39 44 48 57 60

\$FC

00

FC07/

00

\$SJ

00

SJ15/

00

\$CL

00

CL18CL17CL18CL01CL18/

9 10 17 18 60

ACTIVITAT: JOCS TAULA.

SESSIO 8

\$UV

00

UV02UV14UV02UV10UV02UV13UV02UV03UV02/

7 8 23 24 28 33 43 45 60

\$VC

00

VC12VC01VC12VC07VC12VC04VC12VC07VC12VC07/

18 23 33 34 41 42 43 46 56 60

\$CF

00

CF07/

00

\$US

00

US07US08US02US07US10US02US06US02US07US02US10US15US06US10US07US09US15US02

1 2 4 5 7 8 9 10 11 12 17 33 34 35 37 38 43 44

US07US15US02US09US15US02US09/

46 48 49 50 56 57 60

\$LC

00

LC18LC15LC18LC15LC18/

8 9 22 23 60

\$VU

SESSIO 8

00

VU06VU02VU03VU15VU03VU06VU02VU10VU14VU02VU03VU02/

1 5 6 7 10 11 21 23 27 32 34 60

\$CV
00
CV12/
00
\$FC
00
FC07FC03FC07/
7 8 60

\$SU
00
SU15/
00
\$CL
00
CL18CL09CL18/
21 23 60

ACTIVITAT: BINGO.
SESSIO 9

\$UV
00
UV02UV06UV02UV03UV02UV03UV02UV04UV02UV06UV02UV03UV02UV05UV04UV01UV02UV06
1 2 3 4 6 7 8 9 10 11 12 13 14 15 16 17 57 58
UV02UV04/
59 60

\$VC
00
VC12VC07VC12VC08VC12VC08/
10 12 23 24 59 60

\$CF
00
CF07/
00
\$US
00
US02US15US13US15US02US13US15US02US13US02US15US13US02US15/
7 19 22 27 37 38 39 42 43 46 50 53 58 60

\$LC
00
LC18/
00
\$VU
00
SESSIO 9

VU04VU01VU06VU04VU02VU03VU02VU06VU02VU03VU02VU04VU02VU04VU02VU03VU02VU03
1 2 3 9 10 11 13 14 16 20 22 23 24 25 28 35 46 49
VU02VU04VU03/
56 59 60

\$CV
00
CV08CV12CV07CV12CV07CV12CV07CV12CV08CV12/
3 10 11 16 17 32 34 56 58 60
\$FC
00
FC07/
00
\$SU
00
SU15SU13SU15SU05SU02SU15SU05SU02SU08SU02SU15/
11 13 26 27 42 50 51 54 56 57 60

\$CL
00
CL01CL18CL01CL18CL01CL18CL10CL17CL18CL17CL18/
1 3 5 6 10 16 19 20 46 47 60

ACTIVITAT: RELACIONS.
SESSIO 10

\$UV
00
UV03UV02UV03UV10UV14UV10UV14UV10UV14UV03UV07UV06UV04UV03UV04UV03UV07UV06
9 10 11 12 14 16 19 22 25 34 35 36 37 48 51 58 59 60
/

\$VC
00
VC12VC05VC12VC07VC05VC12VC08VC12/
/

16 17 21 23 24 34 37 60

SCF
00
CF07CF06CF07CF06CF07/
16 20 23 25 60

SUS
00
US15US06US15/
12 14 60

SIC
00
IC18LC08LC18LC01LC18LC01LC02LC18LC08LC18LC08LC18/
9 11 12 14 20 22 23 44 45 54 55 60

\$VU
00
SESSIO 10
VU03VU02VU03VU10VU14VU10VU14VU10VU14VU03VU07VU06VU07VU03VU04VU03VU07VU06
9 10 11 12 13 15 19 21 24 33 34 35 36 47 50 58 59 60

/
\$CV
00
CV12CV07CV05CV12CV08CV12/
20 22 23 33 36 60

\$FC
00
FC07FC06FC07FC06FC07/
15 19 22 24 60

\$SU
00
SU15/
60

\$CL
00
CL18CL01CL18CL01CL02CL18/
12 13 19 21 22 60

ACTIVITAT: ENDEVINAR PARAULES.
SESSIO 11

\$UV
00
UV10UV03UV10UV03UV04/
2 6 12 15 60

\$VC
00
VC07VC12VC09VC12/
2 5 14 60

\$CF
00
CF07/
60

\$US
00
US15/
60

\$IC
00
IC18/
60

SESSIO 11

VU12VU06VU12VU03VU05VU14VU03VU04VU14VU04VU03VU12VU02VU12VU06VU07VU12/
3 4 6 11 16 17 31 33 41 45 48 52 54 56 57 58 60

\$CV
00
CV12/
60

\$FC
00
FC07FC04FC07FC04FC07FC04FC07/
2 3 7 8 54 55 60

\$SU
00
SU15SU09SU08/
60

12 51 60

SCI
00
CL18/
00

```

*****
*          COOPERATIVA          *
* TIPUS 3. DURACIONS ACUMULADES. 2 SISTEMES, 9 SESSIONS *
* 10 SUBSISTEMES: UV, VC, CF, US, LC; CONDUCTES *
* CATEGORIES NEN A *
* UV = { UV00, UV01, UV02, UV03, UV04, ....., UV17 } *
* VC = { VC01, VC02, VC03, VC04, VC05, ....., VC12 } *
* CF = { CF1, CF2, CF3, CF4, CF5, CF6, CF7 } *
* US = { US01, US02, US03, US04, US05, US06, ..., US15 } *
* LC = { LC01, LC02, LC03, LC04, LC05, LC06, ..., LC18 } *
*
* CATEGORIES NEN B *
* VU = { VU00, VU01, VU02, VU03, VU04, ....., VU17 } *
* CV = { CV01, CV02, CV03, CV04, CV05, ....., CV12 } *
* FC = { FC1, FC2, FC3, FC4, FC5, FC6, FC7 } *
* SU = { SU01, SU02, SU03, SU04, SU05, SU06, ..., SU15 } *
* CL = { CL01, CL02, CL03, CL04, CL05, CL06, ..., CL18 } *
*
*****

```

```

$
310001
0008
          ACTIVITAT: FER CONJUNTS....
$UV          SESSIO 1
00
UV02UV03UV15UV06UV02UV03UV07UV02UV03UV02UV03UV02UV03UV02/
11 26 27 28 29 30 31 34 35 41 42 46 56 60

```

```

$VC
00
VC07VC09VC07VC09VC12/
1 9 10 58 60
$CF
00
CF07CF04CF03CF07/
5 6 7 60
$US
00
US02US15/
29 60
$LC
00
LC18LC10LC18LC09LC18LC09LC18LC10/
4 5 17 29 47 52 58 60

```

```

$VU          SESSIO 1
00
VU02VU03VU02VU06VU02VU06VU02VU10/
17 25 26 27 39 40 59 60
$CV
00
CV12CV07CV12CV07CV12CV07CV12CV07CV09CV07CV12/
2 10 12 25 27 28 31 32 57 58 60
$FC
00
FC07/
60
$SU
00
SU02SU08SU15/
1 10 60
$CL
00
CL18CL09CL18CL09CL18/
4 10 27 35 60

```

```

          ACTIVITAT: CONSTRUCCIO CASA.
$UV          SESSIO 2
00
UV02UV03UV02UV06UV02UV06UV02UV03UV02UV06UV02UV08UV02UV03UV02UV03UV02UV03
1 5 6 7 8 9 12 16 17 18 19 20 23 24 27 29 30 46
UV02UV03UV02UV03/
50 51 58 60

```

\$VC
00
VC12VC07VC12VC07VC12VC07VC12VC07VC12VC07VC12VC07VC12VC07VC12VC07/
1 4 10 12 13 17 27 29 46 49 50 51 52 54 59 60

\$CF
00
CF07CF04CF07/
53 54 60

\$US
00
US02US15US01US02US08US02US01US02US15US01US02US02US06US02US13US02US13/
2 3 4 5 7 15 18 20 21 22 24 27 28 30 45 46 60

\$LC
00
LC18LC10LC18LC10LC18LC10LC18/
4 5 19 20 21 22 60

\$VU
00
SESSIO 2

VU02VU01VU13VU02VU03VU13/
8 11 14 48 51 60

\$CV
00
CV12CV07CV12CV08CV12/
6 9 50 51 60

\$FC
00
FC07/
00
\$SU
00
SU15SU13SU15SU01SU15SU05SU08SU07SU13SU08SU06SU13SU15/
2 4 8 9 13 14 15 17 44 45 46 48 60

\$CL
00
CL18CL10CL18CL10CL18CL03CL10CL03/
6 8 11 13 49 50 51 60
ACTIVITAT: ELABORACI D'UN CONTE.

\$UV
00
SESSIO 3
UV03UV13UV10UV03UV13UV14UV13UV10UV03UV01UV14UV13UV14UV13/
2 4 5 7 9 11 16 19 20 25 26 46 47 60

\$VC
00
VC07VC12VC07VC12VC05VC12VC07VC12/
2 7 8 20 21 49 51 60

\$CF
00
CF07CF03CF07CF03/
46 51 58 60

\$US
00
US02US09US02US15US02US13US02/
11 26 34 49 51 55 60

\$LC
00
LC18/
00
\$VU
00
SESSIO 3

VU13VU02VU03VU13VU02VU13VU02VU13VU02VU03VU02VU06VU02VU03VU02VU06VU02VU06
1 2 3 4 24 25 31 32 42 43 44 45 48 50 51 52 53 54
VU13VU06VU13/
58 59 60

\$CV
00
CV12CV07CV12CV09CV07CV12CV07CV12CV07CV12CV02CV09CV07/
10 12 28 29 30 40 43 48 53 54 56 57 60

\$FC
00
FC07/

@
\$SU
00
SU02SU13SU02SU09SU02SU08/
24 25 33 41 54 60

\$CL
00
CL18CL17CL18CL17CL18CL17CL18CL17CL09CL18/
1 3 4 5 31 33 48 49 50 60

ACTIVITAT: ELABORACIO D'UN JOC.
SESSIO 4

\$UV
00
UV13UV02UV03UV13UV10UV02UV06UV02UV10UV02UV01UV10UV13UV02/
8 15 22 29 32 34 35 40 44 48 49 51 53 60

\$VC
00
VC09VC07VC12VC07VC09VC12VC09VC12/
7 12 29 47 52 57 58 60

\$CF
00
CF07/
@
\$US
00
US15US06US13/
53 54 60

\$LC
00
LC18LC17LC18/
48 51 60

SESSIO 4

\$VU
00
VU02VU03VU10VU15VU02VU03VU02VU03VU06VU02VU06VU02VU06VU02VU06VU02VU06VU02/
6 7 8 9 29 31 35 42 43 45 48 52 54 57 58 60

\$CV
00
CV12CV07CV09CV07CV09CV07CV12CV07CV09CV07CV12CV07CV12CV07CV09CV07/
1 9 11 14 17 29 30 31 34 36 38 39 42 53 54 60

\$FC
00
FC07/
@
\$SU
00
SU13SU02SU13SU02SU13SU02/
6 11 13 17 29 60

\$CL
00
CL18CL02CL18CL09CL17CL18CL17CL18/
15 16 36 37 38 42 43 60

ACTIVITAT: TERANYINA.
SESSIO 5

\$UV
00
UV05UV10UV06UV10UV06UV10UV05UV11UV13UV11UV13/
6 7 8 9 10 11 24 43 52 53 60

\$VC
00
VC12VC09VC07VC09VC07VC09VC07VC10VC08VC10VC12VC10/
1 3 7 12 19 21 23 28 31 45 52 60

\$CF
00
CF01CF03CF01/
3 14 60

\$US
00
US15US01US15/
28 31 60

\$LC
00
LC01LC18LC01LC02/
28 31 60

6 43 50 60

SESSIO 5

\$VU
00
VU01VU05VU03VU10VU03VU10VU04VU11VU04VU03VU04VU03VU04VU03/
1 5 7 10 19 28 29 31 33 40 41 42 43 60

\$CV
00
CV12CV07CV12CV09CV07CV12CV07CV10CV07CV12CV02CV09CV07/
10 12 28 29 30 40 43 48 53 54 56 57 60

\$FC
00
FC01FC03FC01FC07FC01/
1 5 40 49 60

\$SU
00
SU15/
00

\$CL
00
CL01CL18CL01CL18/
5 55 56 60

ACTIVITAT: RELACIONS.
SESSIO 6

\$UV
00
UV16UV15UV03UV15UV10UV03UV15UV17UV03UV17UV16UV15UV10UV15UV16UV10UV16/
5 9 10 18 19 29 32 33 35 39 40 45 48 49 56 58 60

\$VC
00
VC12VC09VC12VC07VC12VC09VC12VC09VC12VC07VC12VC09VC12VC09/
5 6 14 18 23 24 30 34 35 39 44 47 56 60

\$CF
00
CF07CF04CF07/
24 30 60

\$US
00
US07US13US03US13US01US02US07US13US03US15/
5 9 10 35 36 37 39 45 48 60

\$LC18/
00
00

SESSIO 6

\$VU
00
VU03VU15VU03VU15VU10VU15VU02VU15VU10VU15VU10VU15VU10VU15VU10VU15/
5 14 15 18 20 25 26 39 41 45 46 51 52 55 56 60

\$CV
00
CV12CV07CV06CV12CV09CV12CV07CV12CV07CV09CV07CV12CV07CV12CV09CV07/
6 9 10 18 22 24 26 31 36 40 41 45 47 57 59 60

\$FC
00
FC07FC04FC07/
53 54 60

\$SU
00
SU15SU05SU04SU02SU13SU15SU05SU13SU06SU13/
5 8 9 10 22 25 26 31 32 60

\$CL
00
CL16CL18CL02CL18CL02CL18/
1 27 28 29 32 60

ACTIVITAT: INTERSECCIO LINEES.
SESSIO 7

\$UV
00
UV01UV03UV04UV03UV04UV03UV02UV03UV13UV03UV01UV03UV13UV03UV01/
2 3 7 14 15 20 24 25 41 44 45 46 51 56 60

\$VC
00
VC12VC09VC12VC09VC12VC09VC12/
1 2 3 7 14 15 20 24 25 41 44 45 46 51 56 60

11 14 23 25 30 32 60

\$CF

00

CF01/

00

\$US

00

US15/

00

\$LC

00

LC18LC01LC14LC18LC01LC18/

1 3 5 24 42 60

\$VU

00

SESSIO 7

VU13VU03VU13VU03VU09VU01VU03VU07VU03VU05VU03/

4 14 38 40 41 42 45 46 48 53 60

\$CV

00

CV12CV07CV12CV10CV12CV09CV12CV07CV12CV09CV07/

4 6 7 14 20 21 53 56 57 58 60

\$FC

00

FC01FC07/

56 60

\$SU

00

SU15/

00

\$CL

00

CL18CL16CL18CL16CL18CL01CL18CL16CL18CL16/

4 5 6 8 20 40 56 57 58 60

ACTIVITAT: JOCS DE MEMORITZACIO.

\$UV

00

SESSIO 8

UV10UV14UV04UV05UV07UV03UV04UV14UV06UV14UV04UV03UV04UV06UV14UV04UV14UV04

3 5 6 7 8 9 14 15 16 17 18 19 20 21 24 25 26 30

UV14UV09UV11UV04UV14UV04UV05UV03UV05UV02UV05UV13/

31 40 41 42 44 46 47 48 50 54 57 60

\$VC

00

VC12VC08VC12VC08VC12VC08VC12VC05VC12VC06VC12VC05VC12/

26 28 31 35 39 40 42 43 47 48 50 51 60

\$CF

00

CF04CF07CF03CF07CF03CF07/

7 22 26 47 48 60

\$US

00

US15US06US07US06US07US15/

50 51 52 53 54 60

\$LC

00

LC18LC09LC18LC01LC18LC01LC18LC01LC11LC18LC07LC13LC15LC18/

22 24 26 27 34 35 42 43 45 49 50 53 54 60

\$VU

00

SESSIO 8

VU02VU01VU06VU01VU06VU02VU06VU02VU06VU15VU06VU02VU06VU02VU07VU02VU06VU02

3 4 5 6 7 8 9 20 21 22 23 34 36 40 41 42 43 45

VU03VU02VU06VU02VU14/

47 50 53 55 60

\$CV

00

CV12CV09CV12CV09CV12CV07CV12/

4 5 6 7 9 10 60

\$FC

00

FC04FC07FC06FC07FC04FC07/

27 34 36 43 55 60

\$SU
00
SU15SU06SUJ02SU15/
48 49 50 60
\$CL
00
CL18CL11CL18/
20 21 60