

# DESIGN AND IMPLEMENTATION OF AN ENVIRONMENTAL DECISION SUPPORT SYSTEM FOR THE CONTROL AND MANAGEMENT OF DRINKING WATER TREATMENT PLANTS

**Lluís Godo Pla**

Per citar o enllaçar aquest document:

Para citar o enlazar este documento:

Use this url to cite or link to this publication:

<http://hdl.handle.net/10803/670140>

**ADVERTIMENT.** L'accés als continguts d'aquesta tesi doctoral i la seva utilització ha de respectar els drets de la persona autora. Pot ser utilitzada per a consulta o estudi personal, així com en activitats o materials d'investigació i docència en els termes establerts a l'art. 32 del Text Refós de la Llei de Propietat Intel·lectual (RDL 1/1996). Per altres utilitzacions es requereix l'autorització prèvia i expressa de la persona autora. En qualsevol cas, en la utilització dels seus continguts caldrà indicar de forma clara el nom i cognoms de la persona autora i el títol de la tesi doctoral. No s'autoritza la seva reproducció o altres formes d'explotació efectuades amb finalitats de lucre ni la seva comunicació pública des d'un lloc aliè al servei TDX. Tampoc s'autoritza la presentació del seu contingut en una finestra o marc aliè a TDX (framing). Aquesta reserva de drets afecta tant als continguts de la tesi com als seus resums i índexs.

**ADVERTENCIA.** El acceso a los contenidos de esta tesis doctoral y su utilización debe respetar los derechos de la persona autora. Puede ser utilizada para consulta o estudio personal, así como en actividades o materiales de investigación y docencia en los términos establecidos en el art. 32 del Texto Refundido de la Ley de Propiedad Intelectual (RDL 1/1996). Para otros usos se requiere la autorización previa y expresa de la persona autora. En cualquier caso, en la utilización de sus contenidos se deberá indicar de forma clara el nombre y apellidos de la persona autora y el título de la tesis doctoral. No se autoriza su reproducción u otras formas de explotación efectuadas con fines lucrativos ni su comunicación pública desde un sitio ajeno al servicio TDR. Tampoco se autoriza la presentación de su contenido en una ventana o marco ajeno a TDR (framing). Esta reserva de derechos afecta tanto al contenido de la tesis como a sus resúmenes e índices.

**WARNING.** Access to the contents of this doctoral thesis and its use must respect the rights of the author. It can be used for reference or private study, as well as research and learning activities or materials in the terms established by the 32nd article of the Spanish Consolidated Copyright Act (RDL 1/1996). Express and previous authorization of the author is required for any other uses. In any case, when using its content, full name of the author and title of the thesis must be clearly indicated. Reproduction or other forms of for profit use or public communication from outside TDX service is not allowed. Presentation of its content in a window or frame external to TDX (framing) is not authorized either. These rights affect both the content of the thesis and its abstracts and indexes.



**ATL**  
Ens d'Abastament  
d'Aigua Ter-Llobregat

## DOCTORAL THESIS

Design and implementation of an environmental decision support  
system for the control and management of drinking water  
treatment plants

Lluís Godo Pla

2020





**ATL**  
Ens d'Abastament  
d'Aigua Ter-Llobregat

## DOCTORAL THESIS

Design and implementation of an environmental decision support  
system for the control and management of drinking water  
treatment plants

Annex 1-4

Lluís Godo Pla

2020

Supervised by:

Dr. Hèctor Monclús Dr. Fernando Valero

Tutor:

Dr. Manel Poch

Doctoral Programme in Water Science and Technology

Thesis submitted in fulfilment of the requirements for the degree of Doctor from the  
University of Girona





**ATL**

Ens d'Abastament  
d'Aigua Ter-Llobregat

Dr. HÈCTOR MONCLÚS SALES, Research Professor of the Department of Chemical and Agricultural Engineering and Agrifood Technology of the University of Girona, and Dr. FERNANDO VALERO CERVERA, Head of Research, Development and Innovation and Process Control at Ens d'Abastament d'Aigua Ter-Llobregat (ATL),

WE DECLARE:

That the thesis "Design and implementation of an environmental decision support system for the control and management of drinking water treatment plants", presented by Lluís Godo Pla to obtain a doctoral degree, has been completed under our supervision and meets the requirements to opt for an Industrial Doctorate.

For all intents and purposes, we hereby sign this document.

Dr. Hèctor Monclús

Dr. Fernando Valero

Girona, 28th September 2020



This research was financially supported by the University of Girona and *Ens d'Abastament d'Aigua Ter-Llobregat* with a PhD Student grant (IFUdG-2017/30) and by Retos de la Sociedad Project (CTM2017-83598-R)

LEQUIA has been recognized as consolidated research group by the Catalan Government (2017-SGR-1552)





## Acknowledgements

Al final d'una etapa marcada (entre d'altres coses) per la tesi doctoral, somric comptant tota la gent que n'ha format part d'una manera o una altre, i a tot(e)s els hi vull donar les gràcies per haver-ne format part.

Primerament, vull agrair la confiança dipositada en mi, que ha estat absoluta, als dos supervisors d'aquesta tesi: L'Hèctor i en Fernando. Des del primer moment m'han donat la llibertat i la motivació necessària per poder emprendre les primeres passes en la programació i modelització de processos i aprendre del món de la potabilització d'aigua de la mà d'unes grans persones i professionals. Sense aquesta llibertat per formar-me, explorar, provar, comparar... aquesta tesi hauria estat molt diferent.

A la gent del LEQUIA, que tot i passar la major part del temps fora de Girona, m'heu mantingut el lloc a la oficina i fèieu que els llargs (i freqüentment accidentats) viatges en tren no em fessin gens de mandra. Tant a la facultat com al parc científic, per ser un(e)s incansables del laboratori però per trobar sempre el moment pel *team-building*! I les del IMA per la vostra paciència i fer-nos la vida administrativa molt més agradable! En general, al LEQUIA per ser un grup que aglutina tantes disciplines al voltant de l'aigua que sempre s'hi aprèn alguna cosa nova.

A l'Ens d'Abastament d'Aigua Ter-Llobregat (ATL), per què m'heu obert les portes i l'accés a tot el que he demanat. Tant a la gent de la planta del Llobregat com del Ter i els departaments de Xarxa de Distribució, Sistemes i Telecomunicacions, sempre han buscat el moment dins de l'atragament del dia-dia per atendre'm i discutir sobre qualsevol cosa. I la vostra paciència perquè les aplicacions funcionessin, les reunions de seguiment, les validacions... També a en Pere, que m'ha acompanyat des del principi del projecte *DrinkIA*, sempre disposat a donar un cop de mà. De tots vosaltres n'he après moltíssim!

Als pares i familiars, per aquest suport incondicional i a l'Àngels, que m'ha acompanyat tot aquest temps de la millor manera. Tot i la situació de còvid-19, heu fet que tot això passés gairebé inadvertit i m'heu impulsat per acabar aquest treball.

Moltes gràcies a tots i totes!



## List of publications

Journal publications resulting from this thesis:

- **Godo-Pla, L.**, Emiliano, P., Valero, F., Poch, M., Sin, G., Monclús, H., 2019. Predicting the oxidant demand in full-scale drinking water treatment using an artificial neural network: Uncertainty and sensitivity analysis. *Process Saf. Environ. Prot.* 125, 317–327. <https://doi.org/10.1016/j.psep.2019.03.017>
- **Godo-Pla, L.**, Emiliano, P., González, S., Poch, M., Valero, F., Monclús, H., 2020. Implementation of an environmental decision support system for controlling the pre-oxidation step at a full-scale drinking water treatment plant. *Water Sci. Technol.* 81 (8), 1778-1785. <https://doi.org/10.2166/wst.2020.142>
- **Godo-Pla, L.**, Emiliano, P., Poch, M., Valero, F., Monclús, H., 2020. Benchmarking empirical models for THM formation in drinking water systems: An application for decision support in Barcelona, Spain. (Under review in *Science of the Total Environment*).
- **Godo-Pla, L.**, Rodríguez, J.J., Suquet, J., Emiliano, P., Valero, F., Poch, M., Monclús, H., 2020. Control of primary disinfection in a drinking water treatment plant based on a fuzzy inference system. *Process Saf. Environ. Prot.* 145, 63–70. <https://doi.org/10.1016/j.psep.2020.07.037>
- **Godo-Pla, L.**, Valero, F., Rodríguez, J. J., Emiliano, P., Poch, M., Monclús, H., 2020. Development of a key performance indicator based on quantitative microbial risk assessment for a drinking water treatment plant. (In preparation).



## List of acronyms and symbols

AI	Artificial Intelligence
ANN	Artificial neural network
BN	Bayesian network
BMA	Barcelona Metropolitan Area
CBR	Case-based reasoning
CF	Coagulation/Flocculation
CI	Confidence interval
Cl <sub>Free</sub>	Free chlorine
CP	Critical point
CW	connection weight
D	Dose
DALY	Disability adjusted life years
DBP	Disinfection by-product
DWTP	Drinking water treatment plant
EC	Electrical conductivity
ECDF	Empirical cumulative distribution function
EDR	Electrodialysis reversal
EDSS	Environmental decision support System
fDOM	Fluorescent dissolved organic matter
FIS	Fuzzy inference System
GAC	Granular activated carbon
HRT	Hydraulic retention time
I	Performance index (Microbiological risk assessment)
IO	Operational index (Microbiological risk assessment)
IQ	Quality index (Microbiological risk assessment)
LOV	Lower operational value
LRV	Logarithmic reduction value
MAE	Mean absolute error
MC	Monte Carlo
MEC	Mean Elimination Capacity
MFR	Mean filtration rate
MLP	Multi-layer perceptron
MLR	Multi linear regression
MSA	Mean sludge age
NOM	Natural organic matter
PaD	Partial derivatives method
Pi <sub>annual</sub>	Annual probability of infection (Microbiological risk assessment)
Q	Inflow rate
QMRA	Quantitative microbiological risk analysis
RF	Rapid filtration
RI	Relative importance
RSE	Root squared error

RW	Raw water
Sa	Absolute sensitivity
Si	Relative sensitivity
SOM	Self-organizing map
ST	Storage tanks
SUVA	Specific ultraviolet absorbance
T	Temperature
THMs	Trihalomethanes
THMFR	Trihalomethanes formation risk
TOC	Total organic carbon

# Table of contents

Acknowledgements .....	i
List of publications.....	iii
List of acronyms and symbols.....	v
Table of contents .....	vii
List of Figures.....	xi
List of Tables .....	xv
Summary.....	xvii
Resum .....	xix
Resumen .....	xxi
<b>1. Introduction .....</b>	<b>1</b>
1.1. Drinking water treatment plants .....	3
1.1.1. Disinfection by-products .....	4
1.1.2. Health-based targets .....	6
1.2. Operational challenges and digitalisation of DWTPs .....	6
1.3. Environmental Decision Support Systems.....	10
1.3.1. Model selection for drinking water treatment.....	13
1.3.2. Data-driven models. ....	15
1.3.3. Knowledge-based models. ....	17
1.3.4. Hybrid models.....	18
1.4. Main limitations of EDSSs for DWTP management .....	19
1.5. Motivation .....	20
1.6. Research Hypothesis .....	20
<b>2. Objectives .....</b>	<b>21</b>
<b>3. Methodology .....</b>	<b>25</b>
3.1. Case Study .....	27
3.1.1. Llobregat DWTP .....	29
3.1.2. Ter DWTP .....	30
3.2. Data Acquisition .....	31
3.2.1. Lab analysis Database.....	31
3.2.2. Operational set-points database .....	31
3.2.3. Online sensors database.....	31



3.3. Software .....	33
<b>4. Results I:.....</b>	<b>35</b>
<b>Predicting the Oxidant Demand in a surface water treatment plant: Model development and integration into an environmental decision support system. ....</b>	<b>35</b>
4.1. Background.....	37
4.2. Methodology .....	39
4.2.1. Case study.....	39
4.2.2. Predictive model selection .....	40
4.2.3. Features selection .....	42
4.2.4. Parameter Estimation.....	42
4.2.5. Uncertainty analysis .....	44
4.2.6. Sensitivity analysis.....	45
4.2.7. Case-based reasoning model.....	47
4.3. Results and Discussion.....	49
4.3.1. Features Selection .....	49
4.3.2. Predictive model selection .....	50
4.3.3. Uncertainty Analysis .....	53
4.3.4. Sensitivity Analysis.....	55
4.3.5. Model integration in an EDSS.....	57
4.4. Conclusions.....	60
<b>5. Results II:.....</b>	<b>61</b>
<b>Benchmarking empirical models for THMs formation in drinking water systems and integration into an EDSS.....</b>	<b>61</b>
5.1. Background.....	63
5.2. Methodology .....	65
5.2.1. Case study.....	65
5.2.2. Modelling framework.....	65
5.2.3. Benchmarking of models.....	66
5.2.4. Model Validation .....	67
5.3. Results and Discussion.....	69
5.3.1. EDR performance characterisation .....	69
5.3.2. Benchmark of THMs formation models .....	69
5.3.3. Model Validation .....	73
5.3.4. Environmental decision support system .....	74

5.4.	Conclusions.....	78
<b>6.</b>	<b>Results III.....</b>	<b>79</b>
	<b>Control of primary disinfection in a drinking water treatment plant based on a fuzzy inference system.....</b>	<b>79</b>
6.1.	Background.....	81
6.2.	Methodology .....	83
6.2.1.	Case study.....	83
6.2.2.	Fuzzy inference systems .....	84
6.2.3.	Design of the environmental decision support System.....	84
6.3.	Results and Discussion.....	88
6.3.1.	Development of the control level of EDSS .....	88
6.3.2.	Development of the supervisor level 1 of EDSS .....	90
6.3.3.	Development of the supervisor level 2 of EDSS .....	92
6.3.4.	Implementation and validation of the environmental decision support System	93
6.3.5.	Implications for drinking water treatment.....	96
6.4.	Conclusions.....	97
<b>7.</b>	<b>Results IV .....</b>	<b>99</b>
	<b>Development of a key performance indicator based on quantitative microbial risk assessment for a drinking water treatment plant.....</b>	<b>99</b>
7.1.	Background.....	101
7.2.	Methodology .....	103
7.2.1.	Case study.....	103
7.2.2.	QMRA Framework .....	103
7.3.	Results and Discussion.....	106
7.3.1.	Estimation of source water quality .....	106
7.3.2.	Estimation of process efficiencies on pathogen removal.....	108
7.3.3.	Implementation of QMRA-based KPI for conventional DWTP supervision	112
7.3.	Conclusions.....	116
<b>8.</b>	<b>General discussion.....</b>	<b>117</b>
8.1.	EDSSs for drinking water treatment.....	119
8.2.	Models Integration and Decision Support.....	120
8.2.1.	DrinkIA PTL EDSS.....	120

8.2.2.	DrinkIA PTT EDSS .....	125
8.2.3.	Microbiological risk-based supervisor system.....	127
8.3.	Main contributions regarding the control and management of DWTPs.....	128
8.4.	Present limitations and future steps .....	130
<b>9.</b>	<b>Conclusions</b> .....	<b>135</b>
<b>10.</b>	<b>References</b> .....	<b>139</b>
<b>11.</b>	<b>Annexes</b> .....	<b>155</b>
Annex I.....		157
A1.1.	MATLAB functions .....	157
A1.2.	Model performance metrics .....	158
Annex II.....		161
A2.1.	Sensitivity Analysis .....	161
A2.1.1.	Connection Weight (CW) method.....	161
A2.1.2.	Partial Derivatives Method .....	161
A2.1.3.	Profile Method .....	162
A2.2.	Summary statistics of ANN models .....	163
A2.3.	Correlation of ANN model parameters .....	166
A2.4.	Representation of uncertainty in ANN predictions.....	168
A2.5.	Profile method plots.....	171
Annex III.....		175
A3.1.	Profile method plots.....	175
Annex IV.....		177
A4.1.	Regression results .....	177
A4.2.	Operational conditions at Ter DWTP .....	178
A4.3.	Responses of different EDSS levels .....	179

## List of Figures

<b>Figure 1.</b> Typical surface water DWTP scheme with possible . 1: Source water catchment; 2: Preoxidation; 3: Coagulation/flocculation; 4: Sedimentation; 5: Rapid filtration; 6: Disinfection and storage.....	3
<b>Figure 2.</b> Scheme reflecting the diversity of factors that influence decision-making at operating DWTP .....	7
<b>Figure 3.</b> Schematic of steps followed for the development of an EDSS. ....	11
<b>Figure 4.</b> Generic EDSS structure.....	13
<b>Figure 5.</b> Choose of mathematical model for prediction .....	14
<b>Figure 6.</b> General structure of a multi-layer perceptron.....	16
<b>Figure 7.</b> Scheme of a fuzzy inference system. ....	17
<b>Figure 8.</b> Situation of ATL’s DWTPs. ....	27
<b>Figure 9.</b> Llobregat DWTP treatment scheme for water line. 1: Pre-oxidation; 2: pH Adjustment; 3: Flocculation/coagulation; 4: Settling; 5: Oxidation; 6: Sand filtration; 7: GAC filtration; 8: EDR; 9: Remineralisation; 10: Disinfection and 11: Storage.....	29
<b>Figure 10.</b> Flow diagram of Ter DWTP, showing the different chemicals involved in each process. 1: pH Adjustment; 2: Primary disinfection; 3: Coagulation/Flocculation; 4: Sedimentation; 5: GAC rapid filtration; 6: Secondary disinfection; 7: Storage. ....	30
<b>Figure 11.</b> Placement of quality sensors along the treatment process at Llobregat DWTP .....	32
<b>Figure 12.</b> Placement of quality sensors along the treatment process at Ter DWTP .....	33
<b>Figure 13.</b> Generic model structure for a multi-layer perceptron with a single hidden layer and sigmoid activation function for the prediction of potassium permanganate. $w_{n,k}$ is the weight from input $n$ to node $k$ ; $w_k$ is the weight from node $k$ to the output layer; $b_k$ is the bias balue for node $k$ ; $b_{k+1}$ is the bias value for the output layer node. ....	41
<b>Figure 14.</b> Flow diagram for methodological approach for developing a predictive model.....	46
<b>Figure 15.</b> Flow diagram of predictive and case-based reasoning model integration ....	48
<b>Figure 16.</b> Adjusted R-Squared for all possible combinations of subsets containing from 1 to 8 predictors as input variables in a MLR model for predicting the permanganate dose. ....	49
<b>Figure 17.</b> Residuals of ANN-1 after applying bootstrap method for parameter estimation.....	50
<b>Figure 18.</b> Mean absolute error of model predictions for the MLR and the different MLP-K models, being K=1...9 nodes in the hidden layer. ....	51
<b>Figure 19.</b> Representation of uncertainty predictions for KMnO4 demand time-series using Monte Carlo method for ANN1, ANN4 and ANN7, showing the Monte-Carlo	

simulation outputs, with mean value, 10th and 90th percentile, and the observed KMnO4 demand for the period 13/5/2015-16/5/2015. Probability density of Monte-Carlo outputs on one date (15th May 2015) is also shown. ....54

**Figure 20.** RI computed for ANN-1, ANN-4 and ANN7 models using Connection Weight and Partial Derivatives Method.....56

**Figure 21.** Graphical user interface for the EDSS .....57

**Figure 22.** Results of the implementation phase of the EDSS.....58

**Figure 23.** Replicative and predictive assessment of tested models. ....70

**Figure 24.** Profile method plots of the pre-selected models considering HRT as input variable: A) MLR; B) MLP<sub>8,0</sub>; C) MLP<sub>8,5</sub>; D) MLP<sub>8,6</sub>. n=573. ....72

**Figure 25.** Time series of observed vs model output values of MLR model for samples collected at the DWTP effluent and at the distribution network. N=315. ....74

**Figure 26.** Boxplots indicating the Monte Carlo outputs of MLR at two critical points (CP1 and CP2) when input variables are at the 10th percentile of their historical values. The lines of the plot indicate the 25h, 50th and 75th percentile, and whiskers indicate the extreme values. A) X<sub>EDR</sub>=0%; B) X<sub>EDR</sub>=50%; C) X<sub>EDR</sub>=100%; LOV: Lower operational value; UOV: Upper operational value.....75

**Figure 27.** Boxplots indicating the Monte Carlo outputs of MLR at two critical points (CP1 and CP2) when input variables are at the 90th percentile of their historical values. The lines of the plot indicate the 25h, 50th and 75th percentile, and whiskers indicate the extreme values. A) X<sub>EDR</sub>=0%; B) X<sub>EDR</sub>=50%; C) X<sub>EDR</sub>=100%; LOV: Lower operational value; UOV: Upper operational value.....76

**Figure 28.** Flow scheme of EDSS.....77

**Figure 29.** Hierarchical structure of EDSS employed in this study .....87

**Figure 30.** Membership functions for the inputs (a, b) and output variables (c, d) of FIS<sub>1</sub>. ....90

**Figure 31.** Membership functions for the input (a, b) and output variables (c, d) of FIS<sub>2</sub> .....92

**Figure 32.** Workflow for supervisor level 2 of primary disinfection EDSS.....93

**Figure 33.** Time series of doses proposed by the EDSS and applied at the full-scale DWTP. There is missing data during days 65-84 because the system was temporarily out of service. ....94

**Figure 34.** Disinfection by-products concentration at Ter DWTP effluent during EDSS implementation. There is missing data during days 65-84 because the system was temporarily out of service. ....95

**Figure 35.** Time series of influent water parameters and bacterial load at Ter DWTP.107

**Figure 36.** Decision tree for assigning the expected pathogen load at Ter DWTP. ....108

**Figure 37.** Log inactivation credits from bibliographic values using the total performance index (I<sub>t</sub>) .....109

<b>Figure 38.</b> Time-series of quality and operational parameters used for calculating IQ and IO for coagulation/flocculation and rapid filtration processes. ....	111
<b>Figure 39.</b> Flow scheme followed for determining the status of drinking water.....	112
<b>Figure 40.</b> DALY of Cryptosporidium as a function of coagulation/flocculation and rapid filtration performance in a conventional drinking water treatment. Influent concentration: 0.1 oocysts·L <sup>-1</sup> . ....	114
<b>Figure 41.</b> DALY of Cryptosporidium as a function of coagulation/flocculation and rapid filtration performance in a conventional drinking water treatment. Influent concentration: 0.6 oocysts·L <sup>-1</sup> . ....	115
<b>Figure 42.</b> Screenshot of the DrinkIA-PTLL EDSS: Main screen.....	120
<b>Figure 43.</b> Screenshot of the DrinkIA-PTLL EDSS: Pre-oxidation module.....	122
<b>Figure 44.</b> Screenshot of the DrinkIA-PTLL EDSS: EDR Management.....	123
<b>Figure 45.</b> Screenshot of the DrinkIA-PTLL EDSS: Validation tab. ....	124
<b>Figure 46.</b> Screenshot of the DrinkIA-PTT EDSS: Main screen .....	125
<b>Figure 47.</b> Screenshot of the DrinkIA-PTT EDSS: Primary Disinfection. ....	126
<b>Figure 48.</b> Screenshot of microbiological risk-based supervisor system. ....	127
<b>Figure A 1.</b> Representation of ANN-1 model parameters correlation. ....	166
<b>Figure A 2.</b> Representation of ANN-1 model parameters correlation. ....	166
<b>Figure A 3.</b> Representation of ANN-1 model parameters correlation. ....	167
<b>Figure A 4.</b> Representation of uncertainty in ANN-1 predictions for KMnO <sub>4</sub> demand time-series using Monte Carlo method for ANN1, showing the experimental values vs the model output, with 10 <sup>th</sup> and 90 <sup>th</sup> percentile for the period 1/1/2015-1/9/2018. ...	168
<b>Figure A 5.</b> Representation of uncertainty in ANN-4 predictions for KMnO <sub>4</sub> demand time-series using Monte Carlo method for ANN1, showing the experimental values vs the model output, with 10 <sup>th</sup> and 90 <sup>th</sup> percentile for the period 1/1/2015-1/9/2018. ...	169
<b>Figure A 6.</b> Representation of uncertainty in ANN-7 predictions for KMnO <sub>4</sub> demand time-series using Monte Carlo method for ANN1, showing the experimental values vs the model output, with 10 <sup>th</sup> and 90 <sup>th</sup> percentile for the period 1/1/2015-1/9/2018. ...	170
<b>Figure A 7.</b> Profile method plots for ANN-1. ....	171
<b>Figure A 8.</b> Profile method plots for ANN-4. ....	172
<b>Figure A 9.</b> Profile method plots for ANN-7. ....	173
<b>Figure A 10.</b> Profile method plots of MLR considering variations on input variables: A) UV254; B) TOC; C) Cl <sub>Dose</sub> ; D) Temperature; E) pH; F) Bromide.....	175
<b>Figure A 11.</b> Predicted versus modelled Cl <sub>Free, MC</sub> values from NaOCl and ClO <sub>2</sub> doses. ...	177
<b>Figure A 12.</b> Predicted versus modelled TOC <sub>RW</sub> values from fDOM <sub>RW</sub> and T <sub>RW</sub> values. .	177
<b>Figure A 13.</b> Input values during implementation of EDSS. ....	178

**Figure A 14.** Control level, supervisor level 1 and 2 responses to  $Cl_{FreeMC}$  and  $ClO_2$  Dose along the implementation of the EDSS on the full-scale facility. ....179

## List of Tables

<b>Table 1.</b> Trade-offs in setting operational set-points for different processes at DWTPs..	9
<b>Table 2.</b> Summary of raw water quality at Llobregat and Ter DWTPs. n=365, Period: January 2019- December 2019. <i>N.D.: No data.</i>	28
<b>Table 3.</b> Raw water characteristics of Llobregat DWTP. N=2040 samples from January 2013 to December 2018.	39
<b>Table 4.</b> Statistics used for evaluating the model performance for ANN-1, ANN-4 and ANN-7.	52
<b>Table 5.</b> Characterization of water collected at Llobregat DWTP effluent and different locations along the supply network (Period March 2019 – March 2020), n=573.	65
<b>Table 6.</b> Main performance statistics of pre-selected models.	71
<b>Table 7.</b> Parameter estimators of THM predictive model and delta-mean-squared.	73
<b>Table 8.</b> Main characteristics of Ter DWTP influent and operation conditions. (31/1/2019 - 31/11/2019, n=359).	84
<b>Table 9.</b> Inference rules used in FIS <sub>1</sub> .	89
<b>Table 10.</b> Inference rules used in FIS <sub>2</sub> .	91
<b>Table 11.</b> Pathogen load characterisation at Ter DWTP influent during years 2000-2020. N <sub>T</sub> = Number of total analysed samples; N <sub>p</sub> : Number of positives samples; 50th and 100th percentile values of samples are calculated using only the positives.	103
<b>Table 12.</b> Summary of QMRA-related parameters.	105
<b>Table 13.</b> Values of the quality index (IQ) according to the average value of turbidity (Turb <sub>AVG</sub> ).	110
<b>Table 14.</b> Comparison of regulation limits for several disinfection by-products between the European Council Directive 98/83/EC and its proposed adaptation made in 2018.	131
<b>Table A 1.</b> Descriptions of MATLAB functions.	157
<b>Table A 2.</b> ANN-1 summary statistics of parameter estimators.	163
<b>Table A 3.</b> ANN-4 summary statistics of parameter estimators.	163
<b>Table A 4.</b> ANN-7 summary statistics of parameter estimators.	164





## Summary

Drinking water treatment plants (DWTPs) face changes in raw water quality due to anthropogenic pressure and climate change. To cope with that, DWTPs' managers adjust their treatment units (such as pre-oxidation, coagulation, disinfection...) to produce high quality and safe drinking water at all times. The decision-making involved in this process takes several factors into consideration, including environmental, economic and health factors. Regarding the latter, it is expected that stricter regulations regarding disinfection by-products (DBPs) will increase even more the pressure on this decision-making.

Under the paradigm of digitalisation, drinking water utilities are shifting towards building intelligent control systems to aid humans in facing multi-parametric decisions. Remote sensing generates huge databases that, together with the accumulated experience of process operators and managers, allow the development of models that predict water quality parameters and recommend adequate operational set-points. In this regard, environmental decision support systems (EDSSs) are software tools that integrate different kind of models with the goal of systematising and optimising the decision-making and reducing the time in which a decision is taken.

The present thesis aims at developing an EDSS to face the main operational challenges at DWTPs by providing treatment recommendations in a real-time basis. For this purpose, two full-scale DWTPs (Llobregat and Ter) have been considered as case studies and their needs and processes have been examined.

The control of the pre-oxidation process at Llobregat DWTP has been modelled using artificial neural networks (ANNs) (Chapter 4). To this end, several ANNs and linear regression models have been compared and a comprehensive methodology for parameter estimation, uncertainty and sensitivity analysis has been followed. The resulting model has been integrated in a EDSS for setting the potassium permanganate dosing rate. In parallel, an approach based on case-based reasoning model has been developed for the same process. The integration of these two models in an EDSS allowed to contrast the uncertainty of the developed ANN model with the imprecision related to human decision-making in past situations given similar raw water quality.

To tackle the formation of DBPs issue, two studies have been conducted to explore the consequences of the management of two treatment units on the formation of trihalomethanes (THMs). In the first study, THMs formation models have been compared and calibrated with field-scale data of Llobregat DWTP. Then, the operation

of an advanced treatment consisting in electrodialysis reversal has been modelled and process knowledge has been incorporated to assess the quality of water at two critical points of the distribution network (Chapter 5).

In the second study, in Chapter 6 a fuzzy inference system has been developed for Ter DWTP to tackle the DBPs formation as a result of the primary disinfection process. This process consisted of a sequential dose of sodium hypochlorite and chlorine dioxide. Results from this study have been validated at the full-scale plant with positive validations 85.6% of the time during 6 months.

In parallel, to supervise the overall performance of the plant in terms of microbiological safety, a key process indicator (KPI) was developed (Chapter 7). The framework for quantitative microbiological risk assessment was adapted to real-time approximating some risk-based metrics such as the disability adjusted life years (DALY). This KPI was integrated in a Supervisory Control and Data Acquisition (SCADA) system and to monitor the whole performance of the plant to avoid pathogen-related risks. The presented system is also intended to alert the users about the consequences of certain operation practices or treatment failures.

As a summary, the main contribution of this thesis is to have addressed, modelled and analysed different important challenges regarding variations of raw water quality, formation of disinfection by products and microbiological safety of drinking water by means of developing a variety of intelligent decision support tools. It is worth mentioning that all the developed tools have been integrated in an EDSS and implemented at full-scale DWTPs, where they have been validated by their users.

## Resum

Les estacions de tractament d'aigua potable (DWTPs) afronten canvis en la qualitat de l'aigua a causa de la pressió antropogènica i els efectes del canvi climàtic. Per afrontar-ho, els gestors de les DWTPs ajusten les seves operacions unitàries (com la pre-oxidació, la coagulació, desinfecció...) per tal de produir aigua potable d'alta qualitat en tot moment. La presa de decisions implicada en aquest procés té en compte diversos factors, inclosos els factors mediambientals, econòmics i de salut. Tanmateix, també s'espera que regulacions més estrictes en matèria de subproductes de desinfecció (DBPs) augmentin encara més la pressió sobre aquesta gestió.

Sota el paradigma de la digitalització, les gestores d'aigua s'orienten cap a la creació de sistemes de control intel·ligents per ajudar els personal tècnic a afrontar decisions multiparamètriques. La sensorització dels processos de tractament generen una enorme base de dades que, juntament amb l'experiència acumulada del personal tècnic i dels gestors de planta, pot permetre el desenvolupament de models que prediuen paràmetres de qualitat de l'aigua i recomanen consignes d'operació per ajustar adequadament el procés de tractament d'aigua. En aquest sentit, els sistemes d'ajut a la decisió ambientals (EDSSs) són eines informàtiques que integren diferents tipus de models matemàtics amb l'objectiu de sistematitzar i optimitzar la presa de decisions i reduir el temps en què aquestes es prenen.

Aquesta tesi té com a objectiu desenvolupar un SADA per afrontar els principals reptes operacionals en les DWTPs que utilitzen aigües superficials proporcionant recomanacions sobre tractament a temps real. Per a aquest propòsit, es van considerar dos DWTPs com a casos d'estudi i s'han analitzat els seus processos i necessitats.

El control de l'etapa de pre-oxidació a la DWTP del Llobregat es va modelar mitjançant xarxes neuronals artificials (ANNs) (Capítol 4). Per aquest fi, es van comparar funcionament de ANNs amb models de regressió lineal múltiple i es va seguir una metodologia exhaustiva per a l'estimació de paràmetres i anàlisi d'incertesa. El model resultant es va integrar en un EDSS per ajudar a decidir la dosificació de permanganat potàssic. En paral·lel, es va desenvolupar un model de raonament basat en casos (CBR) pel mateix procés. La integració d'aquests dos models en un EDSS va permetre contrastar la incertesa del model de ANNs desenvolupat amb la imprecisió relacionada amb la presa de decisions en situacions passades donada pel CBR. Aquesta integració va

permetre que l'usuari agafés confiança amb els sistemes de control avançats, fet indispensable per la correcta implementació i validació dels EDSSs.

Per abordar la formació de DBPs, es van realitzar dos estudis per analitzar les conseqüències de la gestió de dues operacions unitàries en la formació de trihalometans (THMs). En el primer estudi, es van comparar i calibrar els models de formació de THMs amb dades de camp de la DWTP del Llobregat. A continuació, es va modelar l'operació del tractament avançat que consisteix en una electrodiàlisi reversible i es van incorporar els coneixements de procés per avaluar la qualitat de l'aigua en dos punts crítics de la xarxa de distribució (capítol 5).

En el segon estudi, al capítol 6, es va desenvolupar un sistema d'inferència difusa a la DWTP del Ter per gestionar la formació de DBPs com a resultat de l'etapa de desinfecció primària. Aquesta etapa consisteix en una dosi combinada d'hipoclorit sòdic i diòxid de clor. Els resultats d'aquest estudi es van validar a la planta a escala real amb validacions positives el 85,6% del temps durant 6 mesos.

Paral·lelament, es va desenvolupar un *key performance indicator* (KPI) per supervisar el rendiment global de la planta en termes de seguretat microbiològica (capítol 7). La metodologia d'avaluació de risc microbiològic es va adaptar per a fer una aproximació en temps real d'algunes mètriques basades en risc, com ara els disability adjusted life-years (DALY). Aquest KPI es va integrar al sistema de SCADA per supervisar tot el rendiment de la planta per evitar riscos relacionats amb els possibles patògens presents a l'aigua d'entrada i també sobre certes pràctiques en la operació de la planta.

En general, en aquesta tesi s'han analitzat i proposat solucions pels reptes originats per les variacions de la qualitat, la formació de la DBPs i la seguretat microbiològica de l'aigua potable. Totes les eines desenvolupades han estat integrades en un EDSS i implementades a escala real, on han estat validades pels propis usuaris.

## Resumen

Las estaciones de tratamiento de agua potable (DWTPs) afrontan cambios en la calidad del agua debido a la presión antropogénica y los efectos del cambio climático. Para afrontarlo, los gestores de las DWTPs ajustan sus operaciones unitarias (como la pre-oxidación, la coagulación, desinfección...) para producir agua potable de alta calidad en todo momento. La toma de decisiones implicada en este proceso tiene en cuenta diversos factores, incluidos los factores medioambientales, económicos y de salud. Sin embargo, también se espera que regulaciones más estrictas en materia de subproductos de desinfección (DBPs) aumenten aún más la presión sobre esta gestión.

Bajo el paradigma de la digitalización, las gestoras de agua se orientan hacia la creación de sistemas de control inteligentes para ayudar al personal técnico a afrontar decisiones multiparamétricas. La sensorización en los procesos de tratamiento genera una enorme base de datos que, junto con la experiencia acumulada del personal técnico y de los gestores de planta, permite el desarrollo de modelos que pueden predecir parámetros de calidad del agua y recomendar consignas de operación para ajustar adecuadamente el proceso de tratamiento de agua. En este sentido, los sistemas de ayuda a la decisión ambientales (EDSSs) son herramientas informáticas que integran diferentes tipos de modelos matemáticos con el objetivo de sistematizar y optimizar la toma de decisiones y reducir el tiempo en que éstas son tomadas.

Esta tesis tiene como objetivo desarrollar un EDSS para afrontar los principales retos operacionales en las DWTPs que utilizan aguas superficiales proporcionando recomendaciones sobre tratamiento a tiempo real. Para este propósito, se consideraron dos DWTPs como casos de estudio y se han analizado sus procesos y necesidades.

El control de la etapa de pre-oxidación en la DWTP del Llobregat se modelizó mediante redes neuronales artificiales (ANNs) (capítulo 4). Para tal fin, se comparó el funcionamiento de ANNs con modelos de regresión lineal múltiple y se siguió una metodología exhaustiva para la estimación de parámetros y análisis de incertidumbre y sensibilidad. El modelo resultante se integró en un SADA para ayudar a decidir la dosificación de permanganato potásico. En paralelo, se desarrolló un modelo de razonamiento basado en casos (CBR) para el mismo proceso. La integración de estos dos modelos en un EDSS permitió contrastar la incertidumbre del modelo de ANNs con la imprecisión relacionada con la toma de decisiones en situaciones pasadas dada por el modelo de CBR. Esta integración permitió que el usuario tomara confianza con los

sistemas de control avanzados, hecho indispensable para la correcta implementación y validación de los EDSS.

Para abordar la formación de DBPs, se realizaron dos estudios para analizar las consecuencias de la gestión de dos operaciones unitarias en la formación de trihalometanos (THMs). En el primer estudio, se compararon y calibrar los modelos de formación de THMs con datos de campo de la ETAP del Llobregat. A continuación, se modelizó la operación del tratamiento avanzado que consiste en una electrodiálisis reversible y se incorporaron los conocimientos de proceso para evaluar la calidad del agua en dos puntos críticos de la red de distribución (capítulo 5).

En el segundo estudio, en el capítulo 6, se desarrolló un sistema de reglas basado en lógica difusa en la DWTP del Ter para gestionar la formación de DBPs como resultado de la etapa de desinfección primaria. Esta etapa consiste en una dosificación combinada de hipoclorito sódico y dióxido de cloro. Los resultados de este estudio se validaron en la ETAP a escala real con validaciones positivas el 85,6% del tiempo durante 6 meses.

Paralelamente, se desarrolló un *key performance indicator* (KPI) para supervisar el rendimiento global de la planta en términos de seguridad microbiológica (capítulo 7). La metodología de evaluación de riesgo microbiológico cuantitativo se adaptó para hacer una aproximación en tiempo real de algunas métricas basadas en riesgo, como los disability adjusted life-years (DALY). Este KPI se integró al sistema de SCADA y puede supervisar todo el rendimiento de la planta para evitar riesgos relacionados con los patógenos y con ciertas prácticas de operación.

En general, en esta tesis se han analizado y propuesto soluciones para los retos originados por las variaciones de la calidad, la formación de los DBPs y la seguridad microbiológica del agua potable. Todas las herramientas desarrolladas han sido integradas en un EDSS e implementadas a escala real, dónde han sido validadas por los propios usuarios.

# 1. Introduction





## 1.1. Drinking water treatment plants

Drinking water treatment plants (DWTPs) are tasked with providing safe water to the inhabitants. They consist of a series of physical and chemical barriers against pathogens and hazardous compounds present in raw water.

The degree to which water is treated depends largely on the quality of the source water. In Spain, most of urban areas are supplied with DWTPs treating surface waters. The chemical and microbiological composition of surface waters depends on the catchment characteristics and are usually subject to contamination from urban, industrial and agricultural systems. In this regard, natural organic matter (NOM), dissolved salts and microbial hazards are the main concerns for surface water DWTPs.

Some common treatment operations at surface water DWTPs include preoxidation, coagulation/flocculation, settling, filtration and disinfection (Figure 1).

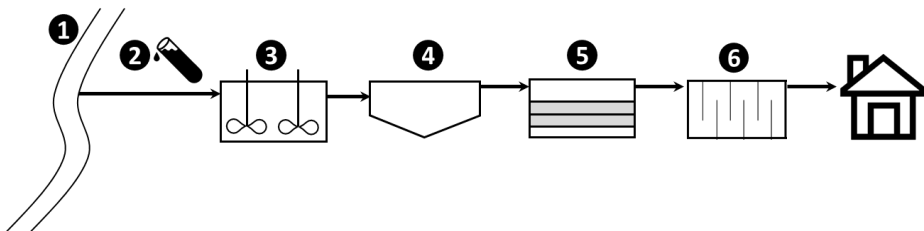

**Figure 1.** Typical surface water DWTP scheme. 1: Source water catchment; 2: Preoxidation; 3: Coagulation/flocculation; 4: Sedimentation; 5: Rapid filtration; 6: Disinfection and storage.

In the preoxidation process, an oxidant is added to water to oxidise a wide range of compounds and/or to provide a first chemical barrier against pathogens. Several oxidants can be used in this process, such as potassium permanganate, chlorine, chlorine dioxide and ozone. The election of the chemical will depend on the raw water characteristics and the formation of disinfection by-products. In the coagulation process, a coagulant is added to water to destabilize negatively-charged colloidal particles such as humic acids. In this process, organic and inorganic particles are removed from raw water. The most common used chemicals are iron and aluminium-based salts. Flocculants are also added to aid in the formation and agglomeration of particles that are big enough to settle by gravity later in the sedimentation process. The remaining particulates in water are removed in the filtration process by different physical

phenomena such as straining and adherence to the filter grains or to previously deposited particles (Crittenden et al., 2012). Several filtration media can be used in this process such as sand, gravel or granular activated carbon (GAC). Depending on the water quality, an additional treatment step might be necessary to remove chemicals that are not removed by the conventional treatment. Membrane technologies such as reverse osmosis (RO) or electrodialysis reversal (EDR) can further remove ionic species such as Bromides. Finally, a disinfectant is usually added to water to ensure the microbiological safety of water and to avoid recontamination along the supply network. Effluent of DWTPs is conveyed through storage tanks and distributed through the supply network before it is consumed at the tap.

### 1.1.1. Disinfection by-products

The discovery of hazardous disinfection by-products (DBPs) during the disinfection process has moved the management of drinking water treatment towards the elimination of DBPs precursors and finding alternative disinfectants. Chlorine has been used since the early stages of water treatment for its properties as a strong oxidant for inactivation of bacteria and viruses and for maintaining a residual disinfectant in water, but it reacts with organic matter and to form halogenated DBPs such as total trihalomethanes (THMs) and haloacetic acids (HAAs).

THMs refer to the sum of four compounds: Chloroform, bromodichloromethane, dibromochloromethane and bromoform. Even the quality standards usually refer to the sum of them, the different compounds present different toxicity effects. For example, brominated-THMs have been particularly regarded for having a potential link with adverse reproductive outcomes (World Health Organization, 2017). Therefore, the proportion of these compounds in the total sum of THMs will also play a role in the toxicity of drinking water. THMs were the first DBPs to be identified as possible agents in drinking water causing bladder cancer were first regulated in the USA since 1979.

Probably because chlorination is the most widely used disinfection technique, whilst other DBPs have been studied, the focus has been on carbonaceous species and THMs in particular (Golea et al., 2017). THMs are regulated in most European countries at 100  $\mu\text{g}\cdot\text{L}^{-1}$ . On the other hand, are included in some regulations but are still not included in the European drinking water directive (98/83/CE, 1998). Anyhow, a revision of this directive dating from 2018 has proposed a limit of 80  $\mu\text{g}\cdot\text{L}^{-1}$  in drinking water. At the regulation level, HAAs are usually regarded as the sum of five compounds: monochloroacetic acid, dichloroacetic acid, trichloroacetic acid, monobromoacetic acid and dibromoacetic acid.

Chlorine is still widely used as disinfectant but other chemicals such as chlorine dioxide, chloramines and ozone are also used at the end of the drinking water treatment process. Chlorine dioxide is also highly effective against waterborn pathogens and does not generate as much organic DBPs as chlorine. On the other hand, this disinfectant needs to be produced on-site and it generates chlorites, which are unregulated DBPs. As regards to chloramines, they generate lesser amount of halogenated DBPs (THMs and HAAs) than chlorine, but they form nitrogenous DBPs such as N-nitrosodimethylamine (NDMA) (Choi and Valentine, 2002).

Ozone is a very strong oxidant, but because of its instability, it cannot produce a disinfectant residual along distribution systems (Singer, 1994). Therefore, it is mainly used in conjunction with chloramines or other disinfectants to ensure that a residual is present in these systems. Ozone reacts with NOM to form organic DBPs such as aldehydes and also with bromide ion to form bromate (WHO, 2000). The presence of bromide and/or iodide in water can shift the formation of DBPs to iodinated or brominated DBPs.

Overall, the formation of DBPs is influenced by several factors such as NOM, temperature, presence of inorganic salts and pH, among others (Chang et al., 2000; Delpla et al., 2009; Nikolaou et al., 2004). The presence of precursors in source water can be related to natural phenomena but also to human activities, and their concentration can suffer from seasonal variations or peaks that require adjustments on the water treatment. For example, the changes in land use, climate change and increase of population can increase NOM concentration in surface waters (Cool et al., 2019).

The regulation of DBPs such as THMs in national regulations (RD 140/2003) and international directives (98/83/CE, 1998) has motivated the addition of new technologies in the drinking water treatment process such as membrane-based technologies, GAC filters or advanced oxidation processes, among others (Crittenden et al., 2012). These technologies are aimed to minimise the formation of DBPs by removing its precursors. As more information on DBPs formation and their toxicological effects in humans, regulation of drinking water is becoming stricter and therefore, managing the treatment process becomes more challenging.

### 1.1.2. Health-based targets

As we have seen in this section, DWTPs rely on multiple barriers to ensure the microbiological and chemical safety of water through various treatment units. Several guidelines have been established for ensuring an adequate removal of pathogens along the treatment process and meet health-based targets at both national and international level (USEPA, 2003, 1998; World Health Organization, 2017, 2016).

Four types of health-based targets are defined for measuring the health, quality and performance objectives of a DWTP based on risk assessments of waterborne hazards: Health outcome targets, Water quality targets, performance targets and specified technology targets (World Health Organization, 2017).

Health outcomes target are a quantitative measure of risk associated with a waterborne hazard, and represent tolerable burdens of disease. Some commonly used metrics are the annual probability of infection and the disability-adjusted life years (DALY). The World Health Organisation guidelines define a tolerable burden of disease of  $10^{-6}$  DALY per person per year. Based on this threshold, the rest of health-based targets (such as quality, performance and specified technology targets) are derived.

Probabilistic methods like quantitative microbiological risk assessment (QMRA) are used at DWTPs to assist in decision-making for managing waterborne microbial hazards and to identify possible scenarios leading to non-acceptable risks for the population.

## 1.2. Operational challenges and digitalisation of DWTPs

DWTP managers have to struggle between operating at a sustainable cost, but without compromising the safety of drinking water. In this sense, in an effort to minimise DBPs, it is clearly stated that the microbiological safety must not be compromised (World Health Organization, 2017). In addition, utilities are subject to other restrictions such as limited budget, stringent regulations, increasing operational costs, variation of raw water quality, among others. Regarding the latter, global change is expected to affect negatively the quality of drinking water. The increase in temperature and rainfalls is expected to have an effect on water quality parameters such as organic matter, micropollutants and pathogens (Delpa et al., 2009). The complexity of DWTP management that is faced in a daily-basis is illustrated in Figure 2.

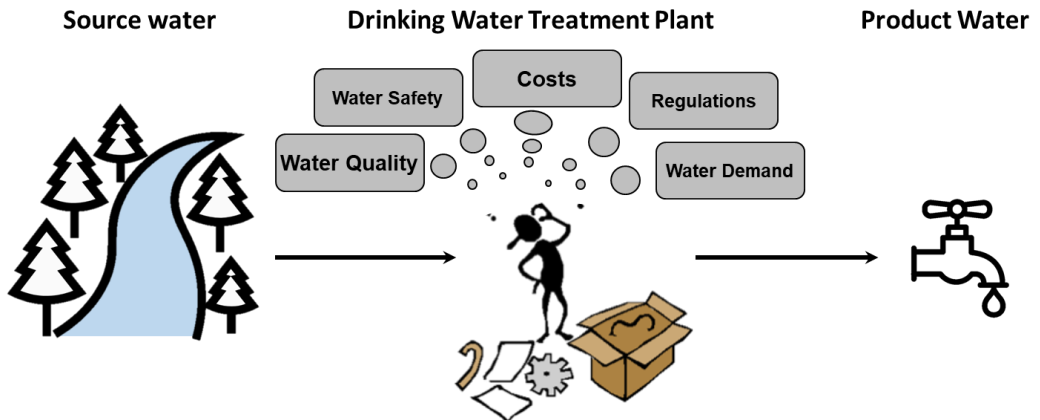

**Figure 2.** Scheme reflecting the diversity of factors that influence decision-making at operating DWTP

The formation of DBPs is largely dependent on the quality of raw water, and this can present huge quality variations over the year at surface water DWTPs due to seasonal or punctual events altering the quality of water. To cope with this, several water quality parameters are routinely monitored at the inlet of DWTPs to characterise physical, chemical and microbiological quality of water.

Specially in Mediterranean catchments, characterised by intermittent flows and for having densely urbanised areas, water at the inlet of DWTPs can be affected by municipal and/or industrial discharges that may happen in the upper part of the basin. In Spain, whereas direct and indirect potable reuse is not permitted by the national regulation, *de facto* or “incidental” reuse of wastewater may occur in some catchments. This fact increases the complexity of raw water to be treated by DWTPs, which might present anthropogenic contamination (mainly organic matter, ammonia, nitrates, pharmaceuticals and faecal-related microorganisms) apart from the typical surface water contamination. In a study conducted by Weisman et al. (2019), the effect of *de facto* reuse on a surface water catchment was investigated and a correlation between the formation of THMs and HAAs and 1% level of *de facto* reuse was found. In Spain, rivers such as Llobregat have been reported to show high levels of *de facto* reuse (Kuster et al., 2008; Mujeriego et al., 2017), having all the problematics associated mentioned above. Therefore, when DWTPs face important changes in short periods of time, adjusting and optimising the operational parameters becomes critical.

Usually, the different treatment units of a DWTP have to be adequately adjusted in order that the overall performance is optimised. For example, an adequate dosing of oxidant at the inlet of a DWTP (e.g. potassium permanganate) will result in a more efficient removal of NOM, Iron and manganese at the posterior coagulation/flocculation stage. However, an overdose of this chemical would result in a residual of manganese in water, that gives a pinkish colour to water and that is corrosive for the pipes. Alternatively, if chlorine or chlorine dioxide was used in this process, an overdose at the peroxidation step would generate high concentrations of DBPs before treatment. Another example is at the coagulation step: Whereas a low dosage of chemical leads to insufficient NOM and particulate matter removal, an overdose of it would lead to artificial sludge creation and increase of the residual aluminium concentration in water (apart from a higher chemical consumption).

At the disinfection process, while adding too little disinfectant would increase the risk of microbial (re)contamination in product water, adding too much disinfectant would lead to intolerable levels of disinfectant residual in tap water. In this latter case, apart from generating taste and odour problems of the product water, but this concentration is regulated to be within a defined range.

Some other trade-offs in setting the adequate operational set-point at DWTPs are summarised in Table 1.

**Table 1.** Trade-offs in setting operational set-points for different processes at DWTPs

Process	Operational set-point	Effects of insufficient treatment	Effects of overtreatment
<b>pH Adjustment</b>	Chemical dosing	Formation of DBPs Hindered coagulation/flocculation	Formation of DBPs Cost of chemicals
<b>Pre-oxidation</b>	Chemical dosing	Non-sufficient removal of pollutants	Formation of DBPs Increase of residual concentration Cost of chemicals
<b>Coagulation</b>	Chemical dosing Sludge age HRT	Non-sufficient removal of pollutants	Increase of residual concentration Cost of chemicals Cost of artificial sludge generation
<b>Flocculation</b>	Chemical dosing	Non-sufficient removal of pollutants	Increase of residual concentration Cost of chemical
<b>Membranes</b>	Modules in operation	Non-sufficient removal of pollutants	Cost of operation
<b>Disinfection</b>	Chemical dosing	Risk of microbial recontamination	Formation of DBPs Cost of chemicals Too much disinfectant residual in product water

Drinking water processes are highly nonlinear and their control go beyond the use of PiD controllers. Instead, operational set-points are typically decided upon previous experience of DWTP users in a specific system. Remote sensing instruments allow a real-time monitoring of water quality, and this can be used for quickly detect and respond to water quality changes (USEPA, 2016). The digitalisation of industry has increased the level of sensors, and this allows the development of predictive tools for automated decision-making and thus, increasing the resilience of DWTPs operation. Therefore, an increasing amount of data is becoming available and data analytics tools can be developed upon them to increase the resilience of these facilities.

The degradation trend of water quality is a factor that outlines the need for predictive tools such as models and decision support systems (Delpla et al., 2009; Raseman et al., 2017). In addition, the shift work of DWTP operators may also lead to problems in



homogenising criteria to unify strategies and optimise operational parameters. Therefore, in the framework of an increasing pressure on water systems, several modelling approaches can be applied using the accumulated knowledge and data from full-scale facilities and be integrated into Environmental Decision Support Systems (EDSS), aiding in the daily operational decision-making (Corominas et al., 2017; Hamouda et al., 2009; Poch et al., 2004).

Integrating modern technologies like EDSS into industrial processes is in alignment with the “Industry 4.0” concept and can bring managerial benefits such as virtualization, real-time capability and service orientation among others (Kamble et al., 2018; Stock et al., 2018).

### 1.3. Environmental Decision Support Systems

Environmental decision support systems (EDSSs) are information systems aimed to reduce the time in which a decision is taken, as well as to ameliorate the consistency and quality of them (Cortés et al., 2000; Poch et al., 2004). EDSS are systems with the objective of delivering contested problems in a structured way, which aims to provide the user with a better understanding of the problem and augment their decision capacity on them (McIntosh et al., 2011).

EDSSs have found successful applications in the water and wastewater treatment field (Hamouda et al., 2009; Raseman et al., 2017; Zhang et al., 2014). Depending on the level of decision the EDSS is designed, their applications can be divided into strategic decisions or for operational or control purposes. Some applications include the exploration of water and wastewater treatment alternatives (Castillo et al., 2016; Comas et al., 2004) and the operation of specific treatment units (Raseman et al., 2017). Even some common steps are followed for all EDSSs, the mathematical models included in them can vary whether they are oriented to the selection of alternatives or to aid in operation or control. This thesis is focused on EDSS for operational control.

Generally, the development of an EDSS can be divided into the following stages: 1) Analysis of the problem; 2) Data and knowledge acquisition; 3) Cognitive analysis; 4) Model selection; 5) Integration and implementation. Processes involved in these stages have been detailed in the literature (Poch et al., 2004) and are summarised in Figure 3.

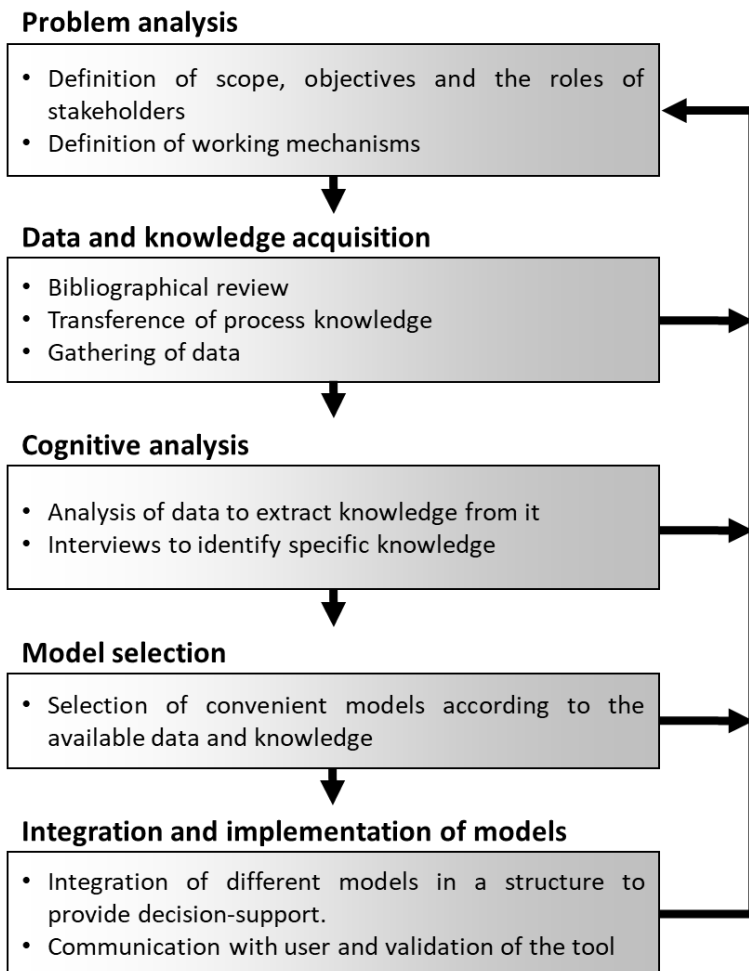

**Figure 3.** Schematic of steps followed for the development of an EDSS.

At the first stage of development, the objectives, expectations and limitations of the EDSS are clearly stated. In this initial phase is key to understand the stakeholders and decision-maker needs, and clearly define the purpose of the tool. Some questions that need to be answered in this stage include which decisions are made at the plant, which stakeholders are taking part in these decisions, and at which time-basis. Additionally, the working mechanisms between developers and practitioners are also established (McIntosh et al., 2011).

Once the objectives of the EDSS have been stated, the acquisition of knowledge from experts and the gathering of data that will be used in further steps to develop models is done. Further on, a cognitive analysis on all this information is done. Applying pre-

processing techniques to data allows to have quality data and at the same time, to avoid propagation of errors in data-driven models that may lead to erroneous decision-making based on them (Gibert et al. 2016). At the same time, additional interviews with experts to gain specific knowledge on certain areas can be done.

The choose of mathematical models that best suit the decision-making problem is of paramount importance. These can be mainly classified in mechanistic (or physically-based) models, statistical and artificial intelligence models (Poch et al., 2004; Raseman et al., 2017). An appropriate model type has to be selected according to their application, the types of data available and the level of uncertainty treatment among others (Kelly et al., 2013). Developing models that are interpretable and/or able to communicate the conceptual path the system uses to reach its recommendations avoids the black box perception of the system and may promote successful implementations of EDSSs (Walling and Vaneeckhaute, 2020).

Finally, the developed models have to be integrated into a functional structure and implemented into the computer systems in order to be executed and consulted. EDSSs are generally structured by a data acquisition level, where all data is gathered and processed (e.g. from DWTP database); a control level, where mathematical models are fed with data and provide an output for the response variable; and supervisor level, which contains expert rules or mathematical models that evaluate the answer given by the control level. The general structure of an EDSS is shown in Figure 4.

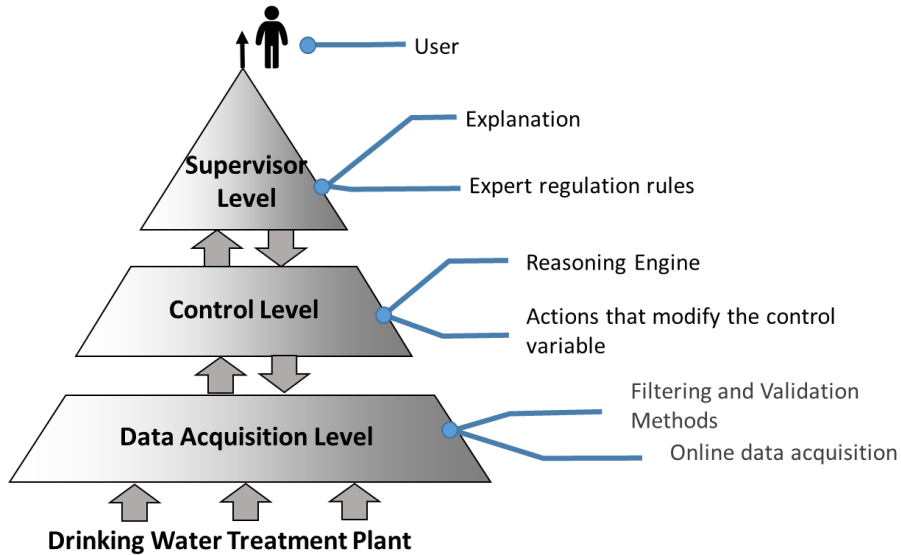
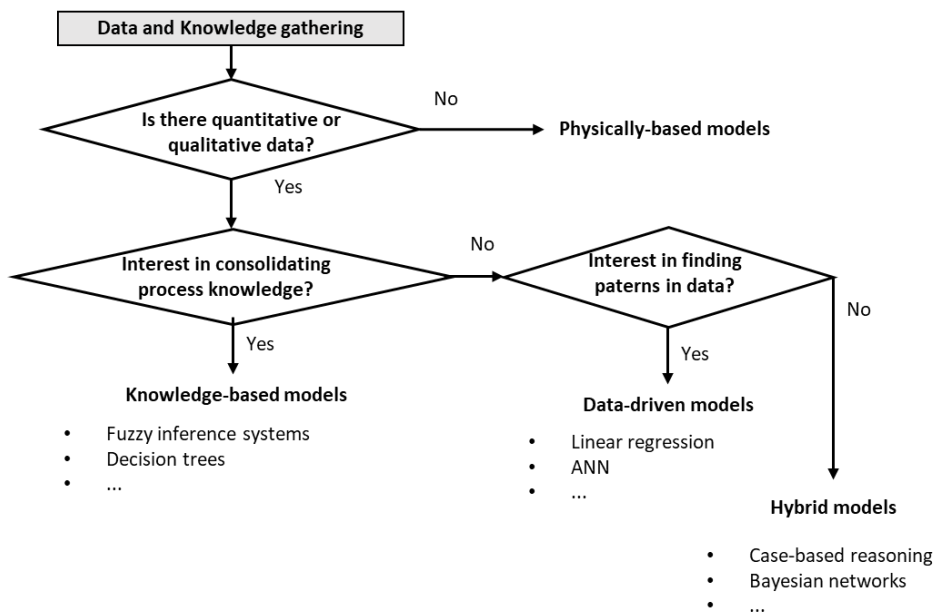

**Figure 4.** Generic EDSS structure

Once the tool has been implemented, it has to be validated by the domain experts. In the validation phase, the performance of the model is assessed and checked whether it is the expected one according to the initial objectives. This process can be iterative, as new problems and challenges can emerge as the EDSS is developed. The success of the EDSS and the end-quality of it will depend on how these challenges are faced during all stages of EDSS development (Walling and Vaneckhaute, 2020).

### 1.3.1. Model selection for drinking water treatment.

The mathematical models are the main component of the EDSS. They should have the ability to reproduce the input-output relationship of a certain process based on previous knowledge (knowledge-based models) or through data-driven approaches and represent the underlying system dynamics between variables (Gass, 1983; Humphrey et al., 2017; Wu et al., 2014). The selection of the type of model will mainly depend on the available knowledge and information of a certain process. In a study conducted by Gibert et al. (2018), a conceptual framework of data mining techniques for solving environmental problems is described, considering the structure of the data and the problem goals. Based on this study and focusing on the selection of predictive models, the framework in Figure 5 can be followed to select an adequate model.



**Figure 5.** Choose of mathematical model for prediction

According to Figure 5, physically-based (or mechanistic) models are used when there is no qualitative neither quantitative data of the process. These models are based on physical and chemical principles, such as mass balances and kinetic models, and are frequently used for design applications in the water treatment literature (Raseman et al., 2017).

When the response of the model is rather qualitative, knowledge-based models such as fuzzy inference systems (FIS) or decision trees can be used. This models are useful where there is process knowledge that can be consolidated and/or the acquisition of data is difficult.

Last, when there is a numerical response and the availability of quantitative data allows it, data-driven models can be selected. These models search for relationships between inputs (or exploratory variables) and outputs (response variables) through algebraic equations. The terms of the equation are usually calibrated through an error minimisation algorithm such as mean-squares, comparing the output of the model with the observed values.

### 1.3.2. Data-driven models.

Statistical models refer to the set of tools that aim to learn relationships and structures from data and have been used for risk assessment and as predictive models in water treatment. Most predictive tools are developed using supervised learning techniques. In these type of models, an output is predicted from one or more inputs (James et al., 2013). Supervised techniques include simple (or multiple) linear regression, logistic regression, regression trees... and a broad range of other techniques. For example, Most of DBPs models reported in the literature are empirically modelled multiple linear regressions (MLR) based on a log-linear power functions, by regressing each one of the water quality parameters influencing DBPs formation (Amy et al., 1998; Chowdhury et al., 2009; Golfinopoulos et al., 1998; Lin et al., 2018; Platikanov et al., 2007). On the other hand, unsupervised techniques find structures or relationships in data, but with no reference output. Some examples can be principal component analysis, use for dimensionality reduction of large datasets or clustering techniques (Gibert et al., 2010).

There are also data-driven systems from the Artificial Intelligence field, and the most popular are artificial neural networks (ANN). ANN have been investigated in the water and wastewater treatment field and became popular in middle 80s (Boger, 1992), but the raise of machine learning, the advances in computational capacity and the amount of deployed sensors that generate real-time data have led to a re-birth of ANNs during the last decade.

The ANN development process can be divided into the following steps: 1) Choice of potential inputs, 2) Data processing, 3) Input Selection, 4) Data division, 5) Selection of model architecture, 6) Optimisation of model parameters and 7) Model validation (Maier et al., 2010), even this process can be generalised to data-driven techniques. To homogenize criteria and guarantee the reproducibility and scientific reporting of these models, some general frameworks and protocols have been proposed for adequately addressing each one of the ANN development steps (Baxter et al., 2002; Maier et al., 2010; Wu et al., 2014). Other studies have reviewed the methodologies used for addressing specific steps of ANN development in the water resources field such as inputs selection (Bowden et al., 2005), data division (Bowden, 2002) or validation step (Humphrey et al., 2017).

Among different possible architectures, multi-layer perceptrons (MLPs) are amongst the most used ANN in the prediction of water quality parameters (Wu et al., 2014). A structure for a single hidden layer MLP is presented in Figure 6. MLPs have minimum three layers: Input layer, where each node represents one input variable; Hidden layer, where each input is weighted and connected with non-linear activated function

(sigmoid) and the Output layer, where the output is calculated from the result of the previous layer nodes through a linear transfer function.

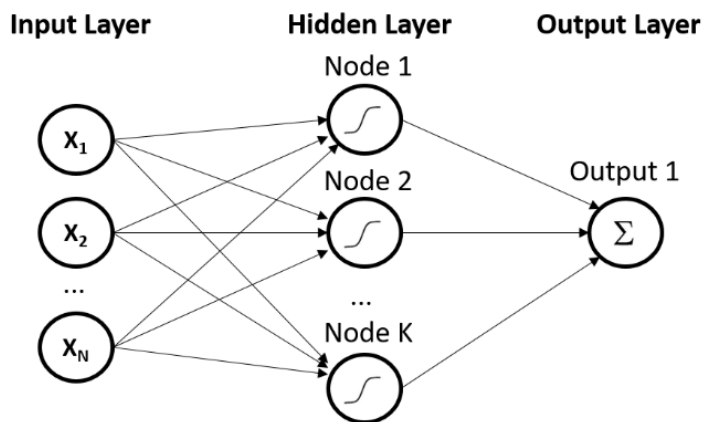

**Figure 6.** General structure of a multi-layer perceptron.

The ability of to detect non-linear complex relationships between data has motivated successful applications of ANN in the drinking water field. The major use of ANNs have been in determining the optimal coagulant dosage from sudden changes in raw water characteristics (like pH, turbidity, alkalinity or temperature) (Baxter et al., 1999; Griffiths and Andrews, 2011; Haghiri et al., 2017; Kennedy et al., 2015; Maier et al., 2004; Tomperi et al., 2013; Wu and Lo, 2008). The main motivation for this is the elimination of routinely jar-testing of raw water to calculate the optimum coagulant dosage, which is time consuming.

The forecasting of water quality in distribution system is an area that has also received attention from researchers. For example, the studies conducted in May et al. (2008) and Wu et al. (2011) provide applications for forecasting disinfectant residuals in distribution systems. The methodology used for developing ANNs for prediction of water resources variables was reviewed in Maier et al. (2010).

Other treatment units have received lesser attention, like some ANN applications evaluating filter performance (Baxter et al., 2002; Hawari and Alnahhal, 2016).

### 1.3.3. Knowledge-based models.

Knowledge-based models (KBMs) are modelling techniques that become suitable for consolidating the process engineering knowledge gained from experience and observations with operating a certain system. KBMs are able to incorporate quantitative and qualitative data and information. Expert opinion can be incorporated in form of rule-based systems through a process called knowledge elicitation. Imprecision related to human decision-making can also be incorporated in these systems through the use of fuzzy sets. Fuzzy inference systems (FISs) are an AI modelling technique that uses the available process knowledge to build a set of rules using fuzzy logic, emulating the human decision-making process. Mamdani's method for building a FIS algorithm is composed by 1) Fuzzification of input variables, where crisp input values are transformed to fuzzy sets by fuzzy membership functions; 2) Rules, where fuzzy if-then "rules" between input and output variables' attributes are defined on the basis of expert knowledge, and 3) Defuzzification, where the fuzzy output variable is transformed to a crisp output (Mamdani and Assilian, 1999). A schematic of this process is represented in Figure 7.

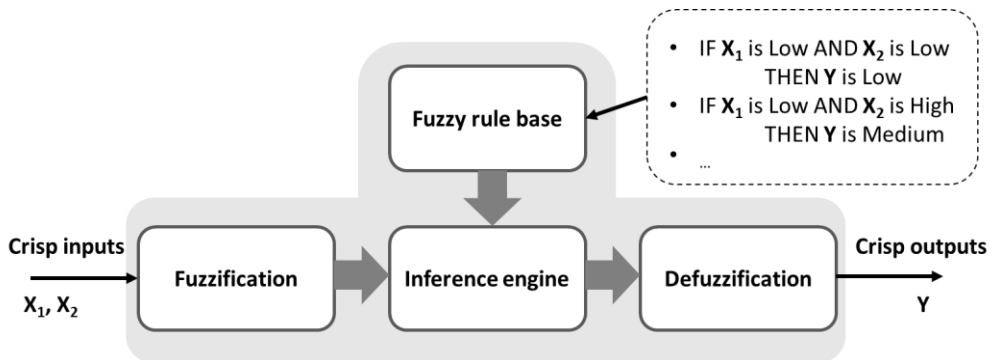

**Figure 7.** Scheme of a fuzzy inference system.

FISs can incorporate high-level expertise to aid in problem solving and provide a flexible knowledge representation capability.

There have been efforts from the scientific community to formalise procedures for knowledge elicitation and including expert opinion into models (Krueger et al., 2012). Kelly et al. (2013) discusses the selection of the most adequate knowledge-based modelling technique, depending on the model requirements and discusses their advantages and disadvantages, as well as provide some further references of applications aimed to solve environmental problems.



In the environmental domain, knowledge-based models have been used in the water and wastewater treatment field for prediction and forecasting, and for improving decision-making in full-scale facilities (Corominas et al., 2017; Kelly et al., 2013). Fuzzy logic-based systems have been used in drinking water treatment to predict coagulant dose from raw water characteristics (Bello et al., 2014; Lamrini et al., 2014) or to evaluate plant design and operations at DWTPs (Chowdhury, 2012; Chowdhury et al., 2007). Oliveira et al. (2019) used fuzzy-logics to develop a quality index for raw water and assess its influence on water treatment.

Other applications of knowledge-based control systems in water-related fields include the automation of an membrane bioreactor control system (Comas et al., 2010), optimisation of methane production in fixed-bed reactors (Robles et al., 2018) or the control of nitrogen removal processes in wastewater (Boiocchi et al., 2016).

#### 1.3.4. Hybrid models

Apart from purely data-driven or knowledge-based models, hybrid models have the ability to use either qualitative and quantitative data.

Case-based reasoning (CBR) is an AI modelling technique that aim to provide solutions to new cases by looking at solutions of previous similar cases (Gibert et al., 2018). The response variables used by these models can be either quantitative (therefore used to forecast or predict values) or qualitative (used for classification purposes). A general CBR model is described by four processes: Retrieve, Reuse, Revise and Retain (Aamodt and Plaza, 1994). These models require a sufficiently big data set to ensure the representativeness of the System. CBR have found Applications in the wastewater treatment field for supervising the treatment management (Núñez et al., 2003; Rodriguez-Roda et al., 2002; Sánchez-Marrè et al., 1997).

Bayesian networks (BNs) establish causal relationships between variables through conditional probabilities. The probability distribution functions can be derived from empirical data but also from expert's knowledge. This ability confers BNs the ability to cope with quantitative and qualitative data in environmental systems. One example of BNs application in the water treatment field is for modelling drinking water treatment failures (Pike, 2004) or to represent uncertainties involved in decision-making in integrated catchment management (Kragt, 2009).

#### 1.4. Main limitations of EDSSs for DWTP management

Despite the growing literature of EDSS applications in drinking water, there are some research gaps that have to be fulfilled regarding the implementation in real DWTPs. Regarding this issue, several authors have described challenges and best practices to successfully implement EDSSs and narrow the gap between science and the market.

Among different authors, some of the challenges faced for EDSS adoption by end-users is the need for involving stakeholders and end user from the very beginning (McIntosh et al., 2011; Poch et al., 2017). Hamouda et al. (2009) reviewed EDSSs applications for selecting water treatment plants and found that the most successful EDSSs (being used) were those tailored to the specific needs of companies and plants. It was also noted that there are too many variables to accommodate a generic EDSSs to the local conditions of a plant. These findings are in agree with a more recent review in Raseman et al. (2017), where it states that EDSSs should reflect more accurately the utility needs.

Therefore, given the lack of generic EDSSs, water practitioners find difficulties in transferring knowledge obtained by previous studies to their local systems and do not have the opportunity to implement this tools for controlling their processes.

## 1.5. Motivation

Drinking water treatment plants, especially in Mediterranean regions face changes in raw water quality. In the framework of increasing stringent regulations and digitalisation of industry, tools to systematise decision-making at full-scale plants are needed. The development of environmental decision support systems has been focused on wastewater treatment during the last decades, and less attention has been paid to the drinking water treatment. The complexity of developing mechanistic models able to describe the physical-chemical processes that occur in drinking water treatment motivates the development of data-driven and knowledge-based models. These models can be built upon practitioners' experience and the available data from the processes. Anyway, this has encountered difficulties when implementing to full-scale facilities.

## 1.6. Research Hypothesis

Given the high degree of digitalisation in modern DWTPs and the little attention that DWTPs have received in EDSSs, it should be possible to develop new models to address operational challenges that DWTPs treating surface water are facing, especially in Mediterranean regions where both anthropogenic and climate pressures are highly affecting the quality of water resources.

Therefore, given the available data and the accumulated knowledge of plant managers, the hypothesis of research is that new models should be developed tailored to DWTPs specific needs. By systematising the decision-making, these utilities would benefit from adopting advanced control systems, permitting a better and more efficient control and management of water treatment processes.

## 2. Objectives



The main objective of the thesis was to develop an environmental decision support system for aiding in the daily decision-making at two surface water DWTPs in Catalonia using the available data and process knowledge. This system is aimed to be used for daily decision-making and therefore, must be compatible with the digital infrastructure of full-scale utilities.

The final EDSS should integrate different modules addressing the operational challenges of two DWTPs by taking into account the raw water quality and other factors that contribute to the control and management of DWTPs in real-time. To these means, several specific objectives were defined:

- To develop a data-driven model for predicting the oxidant demand at the inlet of Llobregat DWTP, and to integrate it in an EDSS structure to aid in decision-making.
- To develop an EDSS module for supervising the DBPs formation risk at Llobregat DWTP and manage the advanced treatment process.
- To develop an EDSS module for controlling the primary disinfection and managing the disinfection by-products formation at Ter DWTP.
- To develop a key performance indicator for supervising the microbial risk at Ter DWTP.



## 3. Methodology





### 3.1. Case Study

Ens d'Abastament d'Aigua Ter-Llobregat (ATL) is the public company that treats and supplies drinking water to Barcelona Metropolitan Area (BMA), which covers 635 km<sup>2</sup> with a population of about 4.5 million inhabitants. Water supplied to this territory comes mainly from surface water (85%) from Llobregat and Ter rivers, and also from two seawater treatment plants (SWTPs) (Figure 8).

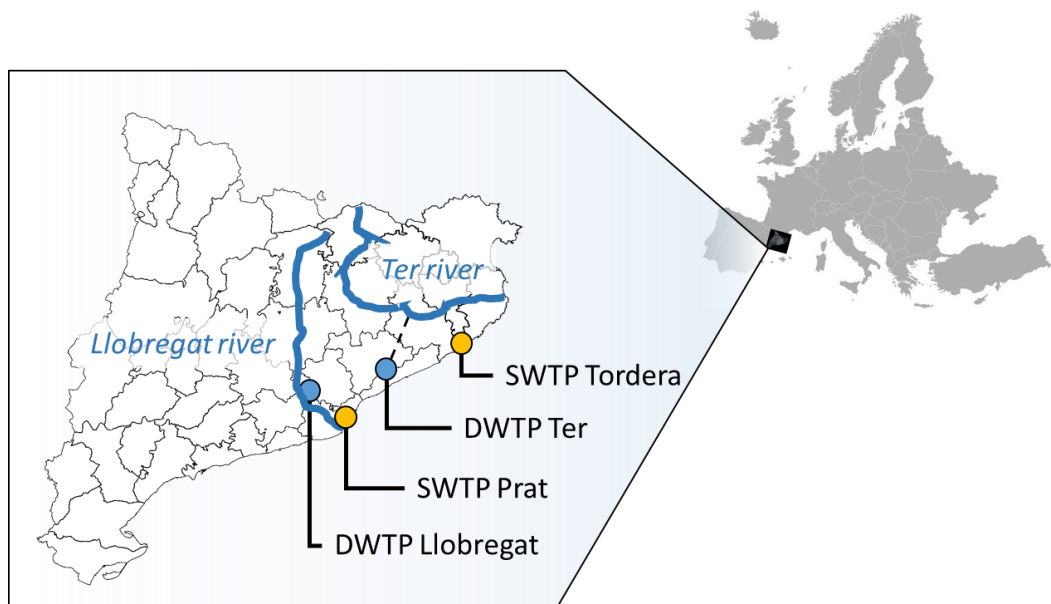

**Figure 8.** Situation of ATL's DWTPs.

To cope with the water demand in all the territory, ATL network is composed by more than 1000 km of pipelines with diameters ranging from 20 to 300 cm. The configuration of the network is flexible and is decided on a day-to-week basis, depending on water demand at BMA and water quality at the sources. Regarding this latter point, water from Llobregat and Ter river present different quality characteristics.

Llobregat DWTP takes water directly from Llobregat river, and is located at the municipality of Abrera. The raw water quality has high concentrations of organic matter, and salinity and has great differences of temperature along the year. This quality issues are related to the mining activities of large salt deposits in the upper part of the basin and also to the Mediterranean climate (J.L. Fernández-Turiel et al., 2000). The water of

Llobregat river receives also the impact from urban and industrial wastewater discharges.

On the other hand, Ter DWTP is located in the municipalities of La Roca del Vallès, Cardedeu and Llinars del Vallès, and takes water from river Ter. The effect of the reservoirs system on the water quality is noteworthy by the low turbidity of water entering at Ter DWTP. Some raw water quality parameters regarding Llobregat and Ter DWTPs are compared in Table 2.

**Table 2.** Summary of raw water quality at Llobregat and Ter DWTPs. n=365, Period: January 2019- December 2019. *N.D.: No data.*

Parameter	Units	Llobregat DWTP	Ter DWTP
Temperature	°C	16.83 ± 6.1	12.90 ± 2.7
Turbidity	NTU	18.84 ± 33.0	0.97 ± 0.3
pH		8.03 ± 0.2	7.99 ± 0.1
UV254	m <sup>-1</sup>	7.53 ± 3.2	6.96 ± 1.2
TOC	mg·L <sup>-1</sup>	3.34 ± 0.7	2.96 ± 0.3
Conductivity	mS·cm <sup>-1</sup>	1.44 ± 0.3	0.47 ± 0.02
Bromide	mg·L <sup>-1</sup>	0.67 ± 0.2	N.D.

As it can be seen, there are some differences in water quality between the two catchments at Ter and Llobregat DWTPs. Llobregat river presents higher fluctuations of temperature, organic matter and salinity. On the other hand, even Ter river has also variations of temperature and organic matter, they are more equalized thanks to the reservoirs' effect. Also, the possibility of taking water from different depths in the reservoirs allows to choose better water quality along the year.

Ter and Llobregat DWTPs are described in wider detail in the following subsections.

### 3.1.1. Llobregat DWTP

Llobregat DWTP has a capacity of treating  $3.2 \text{ m}^3 \cdot \text{s}^{-1}$ , and it is composed by a conventional treatment followed by an advanced treatment. The conventional line is composed by (1) Pre-oxidation with potassium permanganate; (2) pH Adjustment with  $\text{CO}_2$  dosing; (3) Coagulation/flocculation and (4) Sedimentation, (5) Oxidation with chlorine dioxide, (6) Sand filtration and (7) GAC filtration. Following this treatment, a fraction of GAC filtered water is sent to an electro dialysis reversal (EDR) treatment unit (8). This advanced process has modular operation that allows a flexible treatment capacity from 0 to  $2.3 \text{ m}^3 \cdot \text{s}^{-1}$  (corresponding to 60% of total plant capacity) independently from the conventional treatment, by activating from 0 to 9 modules. Additionally, remineralisation of EDR effluent using lime dissolution by carbon dioxide can be applied if necessary (9). Finally, the product water of EDR is blended with conventional treated water and disinfected with sodium hypochlorite (10) before entering the storage tanks (11) and be sent to the distribution network.

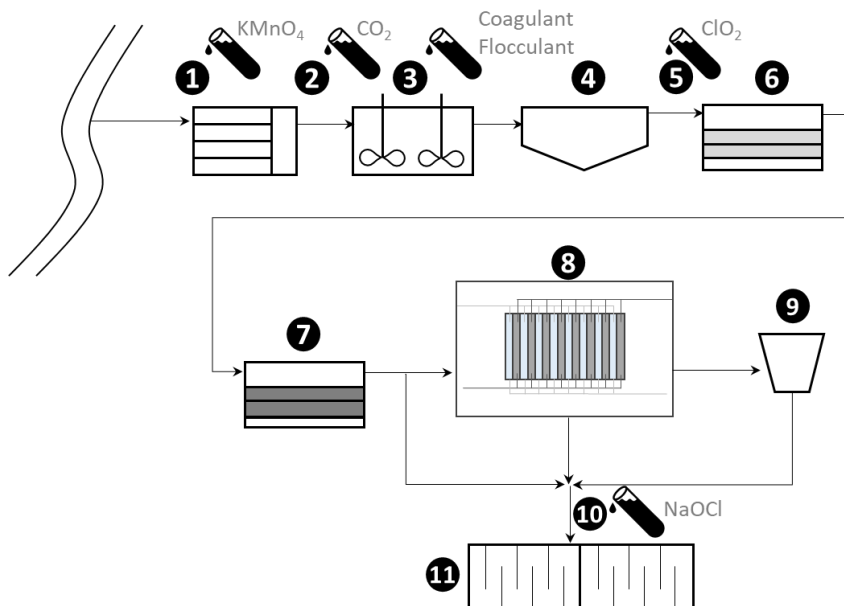

**Figure 9.** Llobregat DWTP treatment scheme for water line. 1: Pre-oxidation; 2: pH Adjustment; 3: Flocculation/coagulation; 4: Settling; 5: Oxidation; 6: Sand filtration; 7: GAC filtration; 8: EDR; 9: Remineralisation; 10: Disinfection and 11: Storage.

### 3.1.2. Ter DWTP

Ter DWTP takes water from a system of water reservoirs connected in series (Sau-Susqueda-Pasteral) of Ter river, through a 56 km gravity-driven pipeline. The treatment train of Ter DWTP includes (1) pH adjustment with carbon dioxide dosing; (2) Primary disinfection with sequential addition of chlorine dioxide and sodium hypochlorite; (3) Coagulation/flocculation using polyaluminum chloride and modified starch followed by (4) Sedimentation; (5) Gravity filtration by GAC media and (6) Secondary disinfection with sodium hypochlorite. Before entering the supply system, the treated water is stored in tanks inside the plant (7). The Hydraulic Retention Time in the storage tanks ( $HRT_{ST}$ ) can range from 0 hours (in by-pass conditions) to 50 hours. Finally, the water is conveyed to different municipal service tanks through the water supply system. Therefore, the HRT of water before it is consumed at the tap can range from few hours to several days. A flow diagram of Ter DWTP is shown in Figure 10.

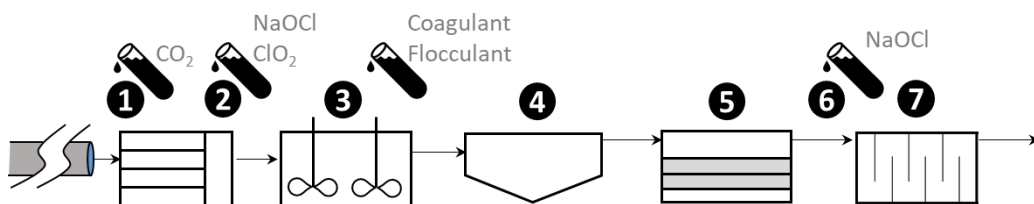

**Figure 10.** Flow diagram of Ter DWTP, showing the different chemicals involved in each process. 1: pH Adjustment; 2: Primary disinfection; 3: Coagulation/Flocculation; 4: Sedimentation; 5: GAC rapid filtration; 6: Secondary disinfection; 7: Storage.

## 3.2. Data Acquisition

Data of Ter and Llobregat DWTPs has been acquired from different sources. Time-stamped samples were downloaded and organised in three different databases depending on the data origin for allowing data analysis and model development. Generally, data was organised in matrixes where each row corresponded to a sample and each column corresponded to a variable. Samples were identified by their date time.

### 3.2.1. Lab analysis Database

ATL routinely monitors quality parameters at different stages of the water treatment. Historical data is accessible through a data management system as part of the quality program of ATL. This data is manually entered and verified in a quality system. It provides a valuable database, which is highly reliable, even each parameter has a different sampling frequency: 2, 4, 12 or 24h. Samples taken at 7 a.m. were selected for building a database of daily-representative values.

This data provides a useful database for characterising raw water quality, and for looking in correlations between variables.

### 3.2.2. Operational set-points database

Operational set-points, as well as chemical consumption are recorded in a database. Data contained in this database are daily means of operational set-points and chemical dosing rates, and represent the average values every 24h.

### 3.2.3. Online sensors database

Data coming from sensors generate a huge amount of data. Most of sensors provide continuous readings. These can be accessed as punctual values, 10-minutes or hourly average values. This data is stored in servers for online monitoring from supervisory control and data acquisition (SCADA) systems.

This data is automatically stored and therefore, there is no check of data quality. This often requires the use of pre-processing techniques before looking for relationships among data or to gain valuable insights. The availability of online measures is crucial for

developing EDSS that can be automatically executed without the need of manual inputs from users. This data is especially useful to look for correlations and quality variations through the day.

The location and amount of water quality sensors in Llobregat and Ter DWTP respond to the utility need of monitoring each treatment process. The placement of quality sensors at these two DWTPs is illustrated in Figure 11 and Figure 12, respectively.

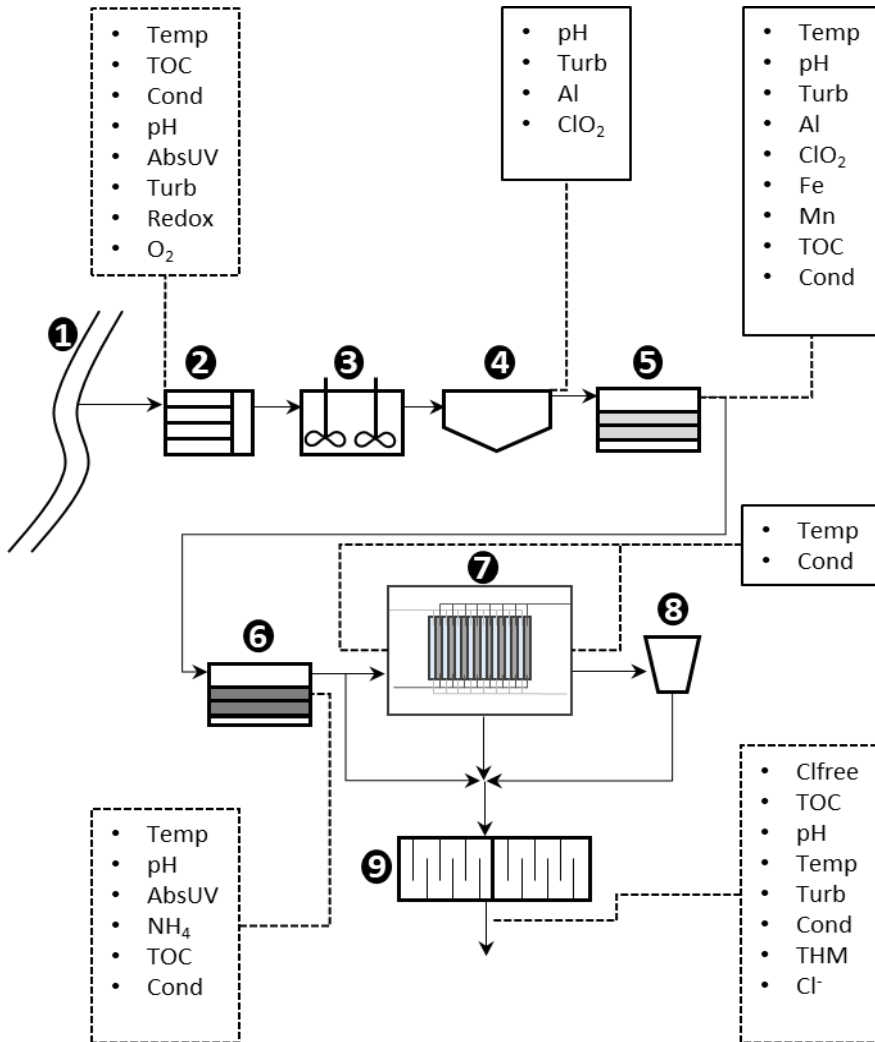

**Figure 11.** Placement of quality sensors along the treatment process at Llobregat DWTP

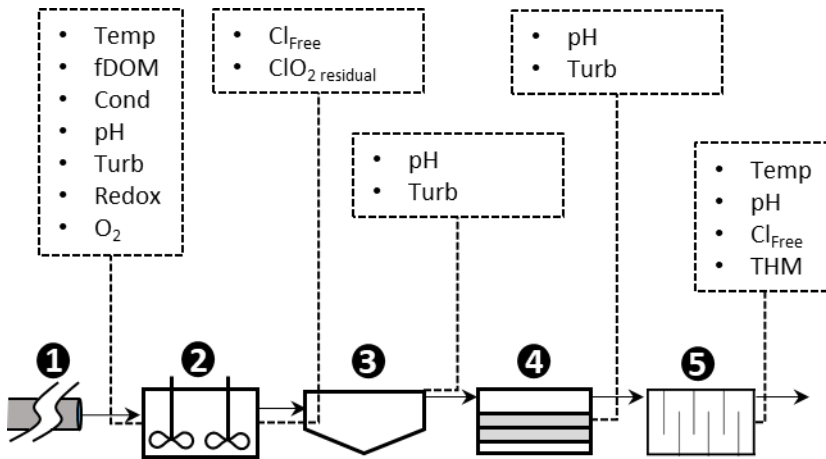

**Figure 12.** Placement of quality sensors along the treatment process at Ter DWTP

### 3.3. Software

MATLAB<sup>®</sup> is a software developed by Mathworks<sup>®</sup> designed to analyse data, develop algorithms and create mathematical models.

Data analysis, development and integration of the EDSS modules, as well as the development of graphical user interfaces in this thesis has been done in MATLAB R2015b. A brief description of some MATLAB functions used in this work, as well as the performance metrics used for model evaluation can be found in the Annex I.





## 4.Results I:

### Predicting the Oxidant Demand in a surface water treatment plant: Model development and integration into an environmental decision support system.

Redrafted from:

**Godó-Pla, L.,** Emiliano, P., Valero, F., Poch, M., Sin, G., Monclús, H., 2019. Predicting the oxidant demand in full-scale drinking water treatment using an artificial neural network: Uncertainty and sensitivity analysis. *Process Saf. Environ. Prot.* 125, 317–327. <https://doi.org/10.1016/j.psep.2019.03.017>

**Godó-Pla, L.,** Emiliano, P., González, S., Poch, M., Valero, F., Monclús, H., 2020. Implementation of an environmental decision support system for controlling the pre-oxidation step at a full-scale drinking water treatment plant. *Water Sci. Technol.* 81 (8), 1778-1785. <https://doi.org/10.2166/wst.2020.142>



## 4.1. Background

Pre-oxidation with potassium permanganate is the first chemical barrier at many DWTPs. This chemical is dosed at the beginning of the treatment to oxidise a wide range of compounds for their subsequent removal by treatment processes. It has some advantages in comparison with other alternatives like chlorine, because it does not generate THMs, a hazardous DBPs of chlorination. This fact becomes very important in utilities that present high THMs formation potential, since it has allowed to move the chlorine dosing at the end of the treatment process, where THMs formation is highly reduced. Permanganate is applied for oxidising iron and manganese, algal-derived compounds, taste and odour compounds, DBPs precursors and for the control of microorganisms in the intake structures or treatment basins (Hu et al., 2018; World Health Organization, 2004).

DWTP treatment managers adjust the permanganate dosing rate according to a multi-parametric evaluation that includes kinetic and inlet quality parameters. At this point, an optimal dosage is the one that maximises the oxidation of a wide group of compounds in raw water (and therefore improving the subsequent treatment unit operations) but does not surpass a certain manganese residual concentration in water. An overdose of permanganate is easily detectable through visual inspection, since it gives water a pink colour. The development of an advanced control tool can help treatment plant managers and operators to deal with this multi-parametric challenge, especially in Mediterranean-like areas where surface water can have strong variations in quantity and quality through the year.

Some permanganate modelling studies have been done targeting the kinetics of microcystins oxidation (Jeong et al., 2017; Kim et al., 2018; Sharma et al., 2012) and identified pH, Dissolved Organic Matter (DOC), UV absorbance of the water at 254 nm (UV254) and specific ultraviolet absorbance (SUVA) as quality parameters that control the kinetics of this process. Some others have focused on the oxidation of organic contaminants and the removal of THMs precursors (Colthurst and Singer, 1982; Hidayah and Yeh, 2018; Hu et al., 2018; Naceradska et al., 2017; Sharma et al., 2012; Zhang et al., 2009). In this point, there is no universally accepted mathematical description of the overall process. EDSSs were designed to cope with this kind of challenges because of their ability to integrate different kinds of mathematical models and expert knowledge (Poch et al., 2004). In this context, artificial neural networks (ANN) have been reported as universal approximators and as a suitable tool for their predictive potential and the

capacity of modelling multiple-variable nonlinear phenomena in water treatment (Baxter et al., 2002; Maier and Dandy, 2000).

Even sensitivity analysis and structural validation can contribute in understanding the inner mechanics of ANNs, one limitation of data-driven models is their lack of transparency (Humphrey et al., 2017; Olden and Jackson, 2002). An EDSS should provide users with a justification of the proposed actions in order to build confidence among users and be a real aid for decision-making (Worm et al., 2010). It is also important the development of user-friendly and web-based systems for improving EDSSs usability (Mannina et al., 2019).

The incorporation of AI techniques into EDSSs has led to more accurate and reliable systems (Núñez et al., 2003). CBR has been used for modelling the experimental knowledge of wastewater treatment plants operation for more than two decades (Sánchez-Marrè et al., 1997), allowing the use of past experiences to solve new cases in a certain process. In the present study, a preliminary approach to a CBR model is approached for backing up the predictive model outputs with a distribution of solutions in the past given similar operating conditions. This way, the precision of the predictive model can be compared with the precision in past decisions for similar input conditions and thus, the confidence in the use of the EDSS for operating a certain process can be strengthened.

The objective of this study was to 1) to develop a predictive model for predicting the potassium permanganate demand for a drinking water treatment plant following a systematic feature and model selection procedures and uncertainty analysis, and 2) Integrate the predictive model with a CBR engine in a EDSS to strengthen confidence on the use of the tool for the daily operation of the process at the DWTP.

## 4.2. Methodology

### 4.2.1. Case study

This study was focused on Llobregat DWTP, as representative example of DWTP treating water from a Mediterranean river with high quality variations over the year. A five-year period was suitably chosen as a time-space for representing the variations that Llobregat DWTP catchment may suffer due to the management plans of the upper part of the basin. A dataset with analytical values and operational data from daily samples collected at 7am was built for the period January 2013-December 2018.

The first step for developing a model is the selection of inputs and outputs. The selected output in this study was the potassium permanganate dose ( $D_{KMnO4}$ ). For selecting the inputs, a pool of input candidates was considered based on the data availability (from commercially available sensors and probes) and on the existence of a known or suspected relationship with the output variable (Baxter et al., 2002). The pool of candidates includes all applicable variables for developing the data-driven model: Raw water temperature ( $T_{RW}$ ), pH ( $pH_{RW}$ ), total organic carbon ( $TOC_{RW}$ ), Turbidity ( $Turb_{RW}$ ), electrical conductivity ( $EC_{RW}$ ), UV absorbance at 254nm ( $UV254_{RW}$ ), Color ( $Color_{RW}$ ) and Inflow rate ( $Q_{RW}$ ). Main characteristics of these parameters are summarised at Table 3.

**Table 3.** Raw water characteristics of Llobregat DWTP. N=2040 samples from January 2013 to December 2018.

Parameter	Unit	Mean	St. Dev	10th Percentile	90th Percentile
$T_{RW}$	°C	16.8	6	8.5	24.9
$pH_{RW}$	-	8.11	0.2	7.85	8.37
$TOC_{RW}$	mg·L-1	3.31	0.8	2.51	4.21
$Turb_{RW}$	NTU	39	35	5	76
$EC_{RW}$	$\mu S \cdot cm^{-1}$	1347	262	1033	1659
$UV254_{RW}$	m-1	6.94	1.9	5.30	9.10
$Color_{RW}$	mg Pt-Co·L-1	11.00	5.0	7.50	16.90
$Q_{RW}$	$m^3 \cdot s^{-1}$	1.85	0.7	0.90	2.80
$D_{KMnO4}$	mg·L-1	0.82	0.3	0.42	1.23

### 4.2.2. Predictive model selection

For modelling purposes, historical data was allocated into a calibration and test dataset (70 and 30%, respectively) to assess model's ability to perform well on data that was not used to calibrate it (generalization property). To ensure that data contained in these subsets contain similar statistical properties, allocation of the data was done using a self-organised map algorithm (May et al., 2010) with the *selforgmap()* function. Therefore, calibration dataset was used for model fitting purposes and for assessing the replicative validation of the models whereas test dataset (unseen during model calibration) was used for predictive validation. Two kinds of modelling techniques were compared: Multiple linear regression (MLR) and multi-layer perceptron (MLP).

A MLR model can be represented in the form:

$$Y = \theta_0 + \theta_1 X_1 + \theta_2 X_2 + \dots + \theta_n X_n \quad (\text{eq. 1})$$

where  $Y$  is the response variable,  $\theta_0$  is the intercept coefficient,  $X_1, \dots, X_n$  are input variables and  $\theta_1, \dots, \theta_n$  are coefficients estimated by a least squares technique. Input data was log-scaled before fitting the multiple linear regression model using *fitlm()* function. Data points below 5% and above 95% of the empirical distribution cumulative function *ecdf()* were marked as outliers and removed from the original dataset after applying a robust regression method.

Multi-layer perceptrons (MLPs) are amongst the most used ANN architectures in the prediction of water quality parameters (Maier et al., 2010; Wu et al., 2014). MLP have minimum three layers: Input layer, where each node represents one input variable; Hidden layer, where each input is weighted and connected with non-linear activated function (sigmoid) and the Output layer, where the output is calculated from the result of the previous layer nodes through a linear transfer function.

The architecture of the presented model is defined by the number of independent or state variables ( $N_{var}$ ) and the number of nodes in the hidden layer ( $K$ ). A scheme of the generic model is shown for  $N=4$  and  $K$  nodes in Figure 13. It consists of two different kind of inputs (State variables or inputs, and Parameters) connected with an output through a single-hidden-layer MLP. For the MLP architecture with a single hidden layer, there is a total amount of  $K \cdot (N_{var} + 2) + 1$  parameters to be estimated.

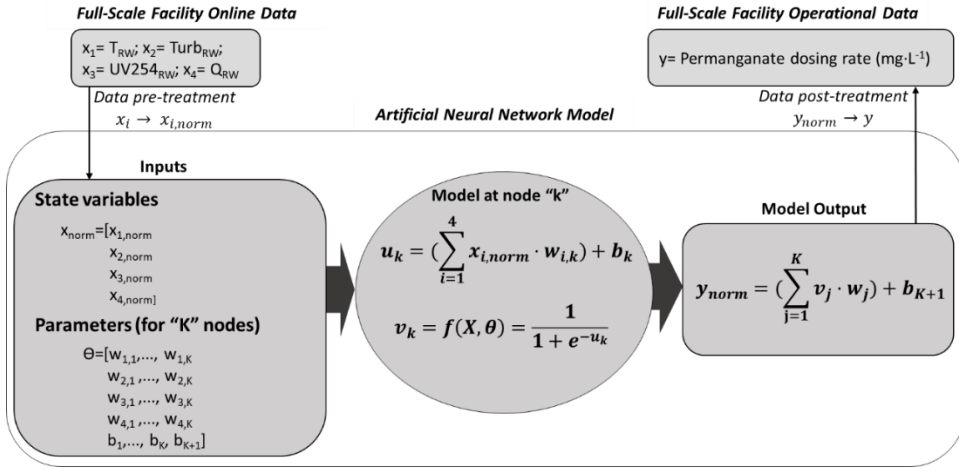

**Figure 13.** Generic model structure for a multi-layer perceptron with a single hidden layer and sigmoid activation function for the prediction of potassium permanganate.  $w_{n,k}$  is the weight from input  $n$  to node  $k$ ;  $w_k$  is the weight from node  $k$  to the output layer;  $b_k$  is the bias value for node  $k$ ;  $b_{K+1}$  is the bias value for the output layer node.

Input variables and outputs were standardized with Z-score transformation. In this operation, input variables are scaled and centred to zero according to the mean and standard deviation using Eq. (2).

$$x_{i,norm} = \frac{x_i - x_{mean}}{x_{Std}} \quad (\text{eq. 2})$$

where  $x_i$  is the  $i^{\text{th}}$  sample for variable  $x$ ,  $x_{i,mean}$  is the mean value of variable  $x$ ,  $x_{Std}$  is the standard deviation and  $x_{i,norm}$  is the normalised value of  $x_i$ . Standardization of input variables is essential to ensure that same percentage change in the weighted sum of the inputs causes a similar percentage change in the unit output (Olden and Jackson, 2002).

The MATLAB Neural Network Toolbox™ was used to obtain parameter values for initialisation of the algorithms. ANN architectures corresponding to a single hidden layer MLP with number of nodes ranging from 1 to 9 in the hidden layer (namely ANN- $K$ , being  $K$  the number of hidden nodes) are assessed in this study for finding the model that best captures the underlying relationships in the experimental data.



### 4.2.3. Features selection

Among all the possible input subsets, a procedure has to be followed to systematically choose the one that provides sufficient prediction accuracy for subsequent model development. The *best subset selection* method was applied to a pool of predictors candidates ( $p=8$ ), including all the quality parameters listed in Table 3. This method consists of fitting models that consider every possible combination of input subsets, using  $p$  predictors, for  $p=1, \dots, 8$  (James et al., 2013), being  $2^p$  the total number of possible combinations. In this case, the predictors are the state variables or independent variables of the predicted system. By doing this, a single best model can be chosen that minimises the cross-validation prediction error or maximises the adjusted R-squared. Adjusted R-squared was used because it adjusts the coefficient of regression to the number of terms in a model. This method is adequate when  $p$  is not large, since it is not computationally efficient.

### 4.2.4. Parameter Estimation

In a parameter estimation problem, a set of model parameter is calculated using an error minimisation algorithm following Eqs. (3) and (4):

$$e_i = y_i - f(x_i, \theta) \quad (\text{eq. 3})$$

$$\theta = \arg \min \sum_{i=1}^N e_i^2 \quad (\text{eq. 4})$$

where  $x_i$  is the  $i^{\text{th}}$  observation of independent (or input) variables,  $y_i$  is the  $i^{\text{th}}$  observation of the dependent (or target) variable  $y$ ,  $\theta$  is the set of unknown model parameters,  $e_i$  is the error between the observed and predicted value on the  $i^{\text{th}}$  observation and  $N$  is the total number of observations. In this method, residuals  $e_i$  (difference between observations  $y_i$  and model outputs  $f(x_i, \theta)$ ) are used to perform a minimisation algorithm using least squares method and find optimal parameter values  $\theta$ .

Typical error minimisation algorithms used in parameter estimation, like least squared, assume a Gaussian distribution of errors and therefore, outliers can have a significant impact on the curve fit. Given the fact that data from a full-scale DWTP is used in this study, the presence of outliers resulting from abnormal conditions during start-up of the treatment or errors in data entry in the database is quite predictable. *Lorentzian* or *Cauchy* distributions can adjust the distribution of errors in a more appropriate manner than a Gaussian fit, because they have wider tails. Therefore, residuals between

observations and model output can be accordingly weighted ( $\omega_{Cauchy,i}$ ) before applying a least-squares method to obtain parameter estimator set  $\theta^*$ , as shown in eq. (5) and (6).

$$\omega_{Cauchy,i} = \frac{1}{1+e_i^2} \quad (\text{eq. 5})$$

$$\theta^* = \text{arg min} \sum_{i=1}^N \omega_{Cauchy,i} \cdot e_i^2 \quad (\text{eq. 6})$$

A robust nonlinear regression method like the iterative reweighted least squares algorithm, assuming a Cauchy distribution of the errors will be used as a first parameter estimation method for advanced outlier treatment. This method was implemented with the *nlinfit()* function, specifying the “Cauchy robust weight function” option.

Following the methodology proposed in Frutiger et al. (2015), an empirical cumulative distribution function (ECDF) of the residuals between experimental data and predicted values from the robust nonlinear regression is used for outlier detection and removal. The basis of this method is that it does not assume a normal distribution of the errors a priori, instead the method estimates directly the underlying cumulative distribution function of the errors and use this to infer outliers. The ECDF is a step function that increases by  $1/n$  in every data point ( $n$  is the number of observations) and was calculated using the *ecdf()* function. According to this method, data points below 2.5% or above 97.5% the probability levels can be considered outliers and removed from the dataset.

Once outliers have been removed from the original dataset, bootstrap method was used as a statistical method for parameter estimation of the model. This method was chosen because it works with the actual distribution of the measurement errors and is considered to be valid to calculate parameter estimation when the underlying distribution of the errors is not known (Sin and Gernaey, 2016). In this method, a first parameter estimation is done using nonlinear least squares minimisation function *lsqnonlin()*, thus obtaining a first set of parameter estimators  $\hat{\theta}_0$ . The residuals from this process ( $\hat{e}$ ) are collected and new residuals subsets  $\hat{e}^*$  are created by random sampling and replacement of  $\hat{e}$ . In this latter procedure, a matrix of size [Nx1] is generated using the random number generator *rand()*, which is then used for sampling residual subsets from  $\hat{e}$ . Several synthetic datasets [ $y_1, y_2 \dots y_{N_{BT}}$ ] are then generated by assigning  $\hat{e}^*$  to the output dataset using a Monte Carlo scheme following Eq. (7).

$$y_i = y + \hat{e}_i^* \quad \text{for } i = 1, 2 \dots N_{BT} \quad (\text{eq. 7})$$

where  $N_{BT}$  is the number of bootstrap samples. This way, the measurement error is simulated in the new datasets.

At this point, it is important to check that the distribution of the residuals of the model output is random. For each synthetic dataset, the parameters are re-estimated, thus obtaining a distribution of the parameter estimators  $\hat{\Theta} = \hat{\theta}_1, \hat{\theta}_2 \dots \hat{\theta}_{N_{BT}} (N_{BT} \times p)$  ( $N_{BT}$  is the number of synthetic datasets and  $p$  the number of parameters estimated) which is supposedly centred to the real value of the parameters. MATLAB Scripts from Sin and Gernaey (2016) were adapted for parameter estimation using Bootstrap method.

After applying Bootstrap method for parameter estimation, several statistics can be computed to assess model performance in terms of replicative and predictive performance. While replicative performance refers to the ability of ANN to fit the calibration dataset, the predictive performance refers to the validation dataset. Mean Absolute Error (MAE), coefficient of determination ( $R^2$ ) and Spearman's rank correlation coefficient ( $\rho^2$ ) can be computed for assessing replicative and predictive performance of the models.

The covariance and correlation matrix of parameter estimators can be obtained directly from  $\hat{\Theta} (N_{BT} \times p)$  using the functions *cov()* and *corr()*, respectively.

The number of parameters to be estimated and therefore, the size of the correlation matrix ( $p \times p$ ) will depend on the architecture of the model. The correlation between two parameters will indicate if the parameter estimators are uniquely identifiable or not.

#### 4.2.5. Uncertainty analysis

A Monte Carlo scheme was used for quantifying the uncertainty of the models resulting from uncertainties in the parameter estimation step. This quantification in full-scale plants is important to increase the awareness of modelling robustness and to avoid bad modelling practices (Borzooei et al., 2019). To these means, 100 parameter sets were sampled from the joint distribution of parameter estimators ( $\hat{\theta}$ ) using multivariate random sampling with *mvnrnd()* function. The probability density of Monte Carlo outputs for each observation can be computed using *ksdensity()* function.

#### 4.2.6. Sensitivity analysis

Sensitivity analysis are used to study the effects of variation in the model inputs onto the model output. ANN sensitivity analysis methods differ from the typical ones used in statistical or mechanistic models in that their parameters (weights and biases values of the hidden and output layer) do not have any physical meaning by itself. Humphrey et al. (2017) highlights the importance of considering and reporting the structural validity of artificial neural network models (in addition to predictive and replicative validity) in order to make plausible models and to certify that the model has captured well the underlying relationship in the calibration data. In this regard, several sensitivity techniques to quantify the relative importance (RI) of ANN inputs are reported and discussed in the literature (Humphrey et al., 2017; Olden and Jackson, 2002; Sarle, 2000).

Among several techniques, Connection Weight (CW), Partial Derivatives (PaD) and Profile Method (PM) are chosen in this study as two different methods for quantifying RI of inputs: The first one, based on the connection weights between input-hidden and hidden-output layers of ANN; and the second and the third one, based on the effects of variation of the inputs onto the output of the ANN model. Details of theory are given in the Annex II (A2.1), and for further details and discussions on these methods, the interested reader can read the work of Humphrey et al. (2017).

A scheme of the methodological approach covered in this study is summarised in Figure 14.

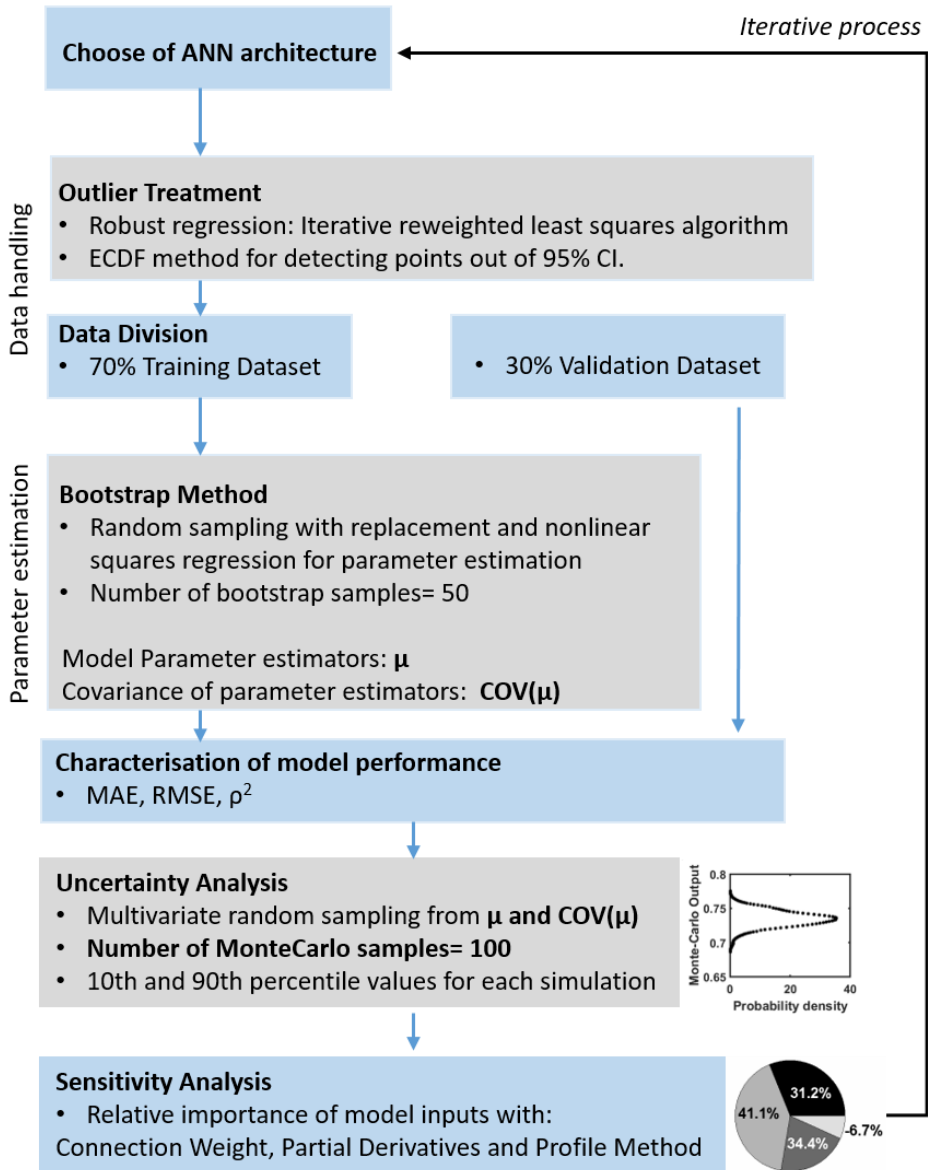

**Figure 14.** Flow diagram for methodological approach for developing a predictive model.

#### 4.2.7. Case-based reasoning model

CBR is an AI modelling technique that aim to provide solutions to new cases by looking at solutions of previous similar cases. In the present application, a CBR model was approached to provide the user with information about which permanganate doses were used in the past, given similar raw water and operational characteristics. A general CBR model is described by four processes: Retrieve, Reuse, Revise and Retain (Aamodt and Plaza, 1994). At the present study, the preliminary approach to CBR model only comprises the first two processes, that consist of 1) Retrieving the most similar cases and 2) Reusing the solutions (permanganate dosing rate) in these cases to support the predictive model outputs. Local and global similarity indices were used to find the most similar cases to the current one. Local similarity was assessed using domain expert knowledge in a binary basis, as expressed in eq. (8):

$$SIM_{local}(C_{i,k}, C_{j,k}) = \begin{cases} 1 & \text{if } C_{j,k} \in [C_{i,k} - atr_k, C_{i,k} + atr_k] \\ 0 & \text{otherwise} \end{cases} \quad (\text{eq. 8})$$

where  $SIM_{local}$  is the local similarity measure of attribute  $k$  between cases  $C_i$  and  $C_j$ ,  $C_{i,k}$  is the value of attribute  $k$  in case  $C_i$  and  $atr_k$  is the local similarity for attribute  $k$ . Domain knowledge was used to assign  $atr_k$  values. For  $k = T_{RW}$ ,  $Turb_{RW}$ ,  $UV254_{RW}$  and  $Q_{RW}$ ,  $atr_k$  was set to 2.5 °C, 20 NTU, 1.5 m<sup>-1</sup> and 0.5 m<sup>3</sup>·s<sup>-1</sup>, respectively.

Global similarity ( $SIM_{global}$ ) between two cases ( $C_i$ ,  $C_j$ ) was also assigned in a true/false basis, being true only if all local similarities were true.

$$SIM_{global}(C_i, C_j) = \begin{cases} 1 & \text{if } \forall k, SIM_{local}(C_{i,k}, C_{j,k}) = 1 \\ 0 & \text{otherwise} \end{cases} \quad (\text{eq. 9})$$

Given a case  $C_0$ , the probability density of solutions for all cases  $C_1 \dots C_N$  from the historical database where  $SIM_{global}=1$  can be computed as a means to illustrate operator's behaviour uncertainties in similar past situations. Note that in the present study it is not intended to find the most similar case and provide a unique solution rather than providing the user with a distribution of similar actions done in the past. Therefore, this

preliminary approach to CBR model gives a probability distribution of past actions that is comparable to the uncertainty analysis made for the predictive model.

A schematic of how the predictive and the CBR model outputs are integrated is shown in Figure 15.

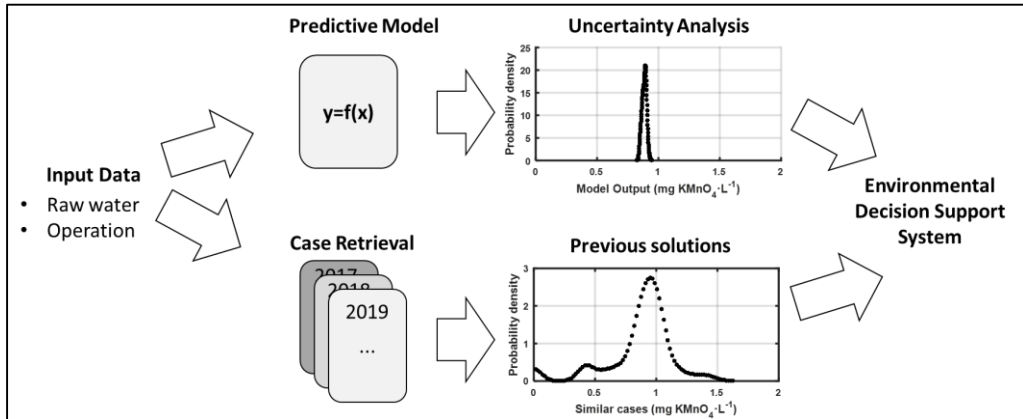
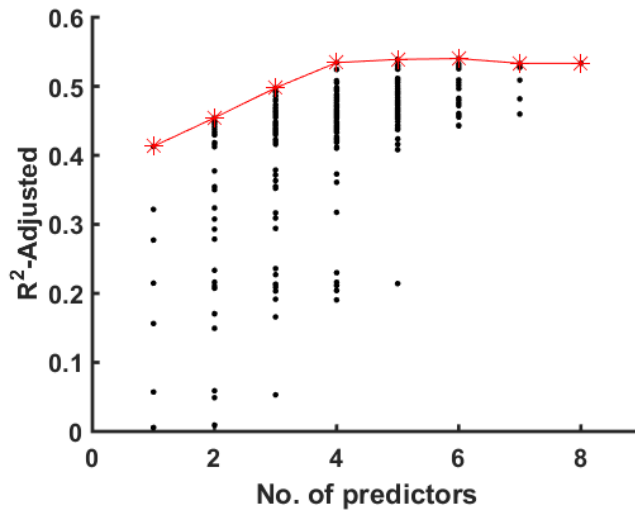

**Figure 15.** Flow diagram of predictive and case-based reasoning model integration

### 4.3. Results and Discussion

#### 4.3.1. Features Selection

*Best subset selection* method was followed for selecting the features of the data-driven models. Results after fitting MLR models with all possible input subsets containing from  $p=1\dots 8$  predictors are shown in Figure 16.



**Figure 16.** Adjusted R-Squared for all possible combinations of subsets containing from 1 to 8 predictors as input variables in a MLR model for predicting the permanganate dose.

It can be seen that as the number of predictors increase, the model accuracy in terms of adjusted R-squared increases but at  $p=4$ , the inclusion of an additional predictor in the MLR model does not correspond to a significant increase in the adjusted- $R^2$ . Within the all possible combinations including four variables, the subset that maximises model accuracy included the following state variables:  $T_{RW}$ ,  $Turb_{RW}$ ,  $UV254_{RW}$  and  $Q_{RW}$ , with an adjusted R-squared of 0.54.

The selected subset was considered to have physical meaning in the pre-oxidation process.  $T_{RW}$  strongly affects the kinetics and solubility of permanganate in water, and seasonal variability is strongly related to this. Turbidity and UV254 are surrogate measures for suspended solids, organic matter and sediments, among others. These parameters are usually associated with organic loads resulting from river's runoff, being



positively correlated with the permanganate dose. The inflow rate is inversely proportional to the contact time that water is in contact with permanganate in the pre-oxidation chamber and also in the clarifiers, thus affecting the oxidation process. Other parameters like  $\text{pH}_{\text{RW}}$  did not result in the best input subset. This might be because pH is adjusted at the inlet of the DWTP targeting a value of 7.45 by a carbon dioxide dosing. Therefore,  $\text{pH}_{\text{RW}}$  didn't show to play a key role, as expected.

### 4.3.2. Predictive model selection

Bootstrap method was applied on the outlier-treated dataset and selected ANN architectures. The residuals obtained using this method were checked and shown in Figure 17, which confirmed to follow a random pattern scattered around mean close to zero. This confirms the suitability of using bootstrap method to quantify the effect of measurement error on model performance (Efron, 1979; Frutiger et al., 2016). The mean of the parameter estimator matrix ( $\hat{\theta}$ ) calculated after bootstrapping for every ANN architecture were used for model performance evaluation.

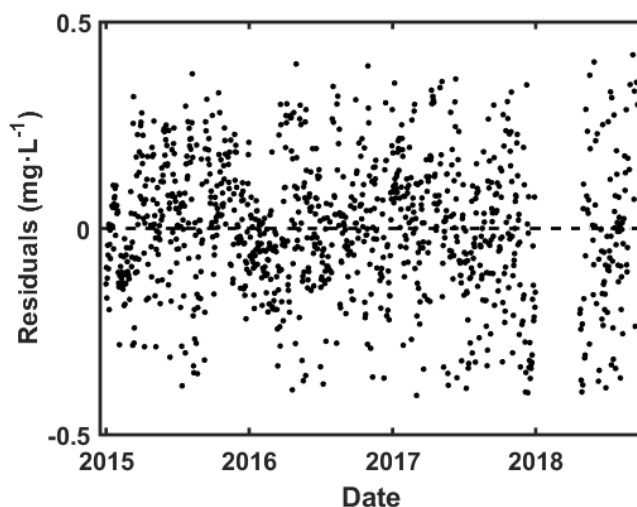

**Figure 17.** Residuals of ANN-1 after applying bootstrap method for parameter estimation

The performance statistics of MLR and MLP models using the selected features, after exclusion of ECDF outliers and resulting from applying Bootstrap method for parameter estimation were compared for the selection of the predictive model. Results using both

calibration (replicative validation) and test dataset (predictive validation) are shown in Figure 18.

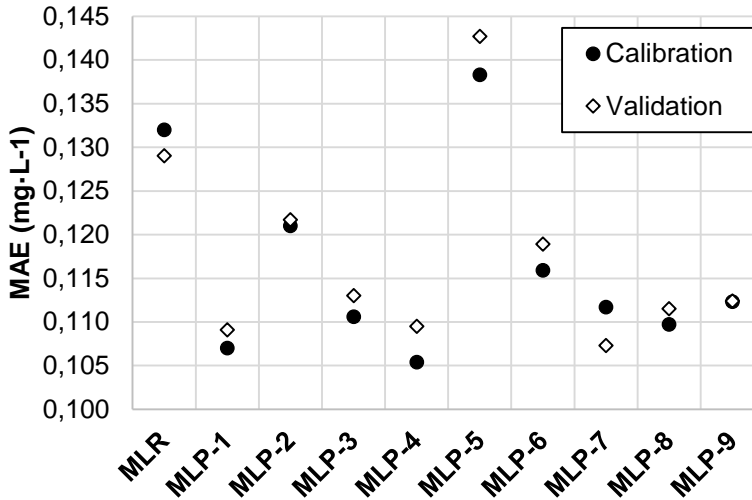

**Figure 18.** Mean absolute error of model predictions for the MLR and the different MLP-K models, being K=1...9 nodes in the hidden layer.

MLR showed similar performance compared to MLP models. For evaluating model performance, the attention is focused on the validation dataset, since it is unseen data during the model development phase. In Figure 18, three minimum MAE areas can be observed for the validation dataset. The first one, at K=1 with MAE= 0.109 mg·L<sup>-1</sup>; the second one at K=4 with MAE=0.109 mg·L<sup>-1</sup> and the third one at K=7 with MAE= 0.107 mg·L<sup>-1</sup> respectively. More details of the performance of these models is given in Table 4. As can be observed among ANN-1, ANN-4 and ANN-7, all of the performance statistics are in the same range for both calibration and validation dataset and there is no clear difference among them regarding these metrics. On the other hand, MLR showed worst results with MAE of 0.129 mg·L<sup>-1</sup> on the validation dataset.

**Table 4.** Statistics used for evaluating the model performance for ANN-1, ANN-4 and ANN-7.

Model	No. of Parameters	Dataset	MAE	R <sup>2</sup>	ρ <sup>2</sup> (Spearman)
MLR	5	Calibration	0,132	0,64	0,778
		Validation	<b>0,129</b>	<b>0,64</b>	<b>0,785</b>
ANN-1	7	Calibration	0,127	0,76	0,770
		Validation	<b>0,128</b>	<b>0,74</b>	<b>0,801</b>
ANN-4	25	Calibration	0,125	0,76	0,796
		Validation	<b>0,129</b>	<b>0,75</b>	<b>0,804</b>
ANN-7	43	Calibration	0,125	0,74	0,798
		Validation	<b>0,127</b>	<b>0,75</b>	<b>0,810</b>

Llobregat DWTP treatment managers accepted model predictions that have discrepancies regarding their operational data in the 0-0.15 mg·L<sup>-1</sup> range. Therefore, the values found for MAE, R<sup>2</sup> and ρ<sup>2</sup> confirm the applicability of the models to predict the permanganate demand in terms of predictive performance. The selected models (ANN-1, ANN-4 and ANN-7) were selected to further assess their performance through uncertainty and sensitivity analysis.

The mean, standard deviation of model parameters, the 95% confidence interval (CI) and the correlation matrix can be calculated from the covariance matrix obtained after applying bootstrap method. The correlation matrix of  $\hat{\Theta}$  can help in determining if parameter estimators are uniquely identifiable or not. The summary statistics and correlation values of  $\hat{\Theta}$  for the different ANN models are provided in the Annex II (A2.2 and A1.3, respectively).

Without taking into account the correlation of a parameter with itself, ANN-1 showed 47.62% of the correlation coefficients (in absolute terms) above 0.5. These means that a big part of parameter estimators are strongly correlated (have similar sensitivity to the model output) and thus, not uniquely identifiable. On the other hand, ANN-4 and ANN-7 showed only 3.78 and 1.00% of the correlation values above this number.

Overall, these identifiability issues (the fact unique parameter estimation is not possible) means that when ANN model is used for prediction, the simulations with the ANN model should be performed considering not only the mean values but also the covariance matrix of the parameters of the model, i.e. by performing MC simulations. The outcome of MC simulations will provide mean and variance of the ANN predictions. Identifiability of ANN parameters is not usually reported. Parameters with identifiability issues should not be attributed physical meaning since their values are not unique (Frutiger et al., 2016).

### 4.3.3. Uncertainty Analysis

MC method was used for sampling different parameter subsets from the parameter estimator covariance matrix. In total, 100 different parameter estimator subsets  $\theta_i$  were obtained using multivariate random sampling. The model output for ANN-1, ANN-4 and ANN-7 including 10<sup>th</sup> and 90<sup>th</sup> percentile and mean value of MC simulations are shown in Figure 19.

The spread of MC output is also represented by showing the probability density of the outputs at one specific data point. The higher extent of uncertainty in parameter estimators, the larger spread of MC outputs for each data point. Time -series plots of model output versus observed data including 10<sup>th</sup> and 90<sup>th</sup> percentile of MC simulations for the whole studied period are included in the Annex II (A2.4).

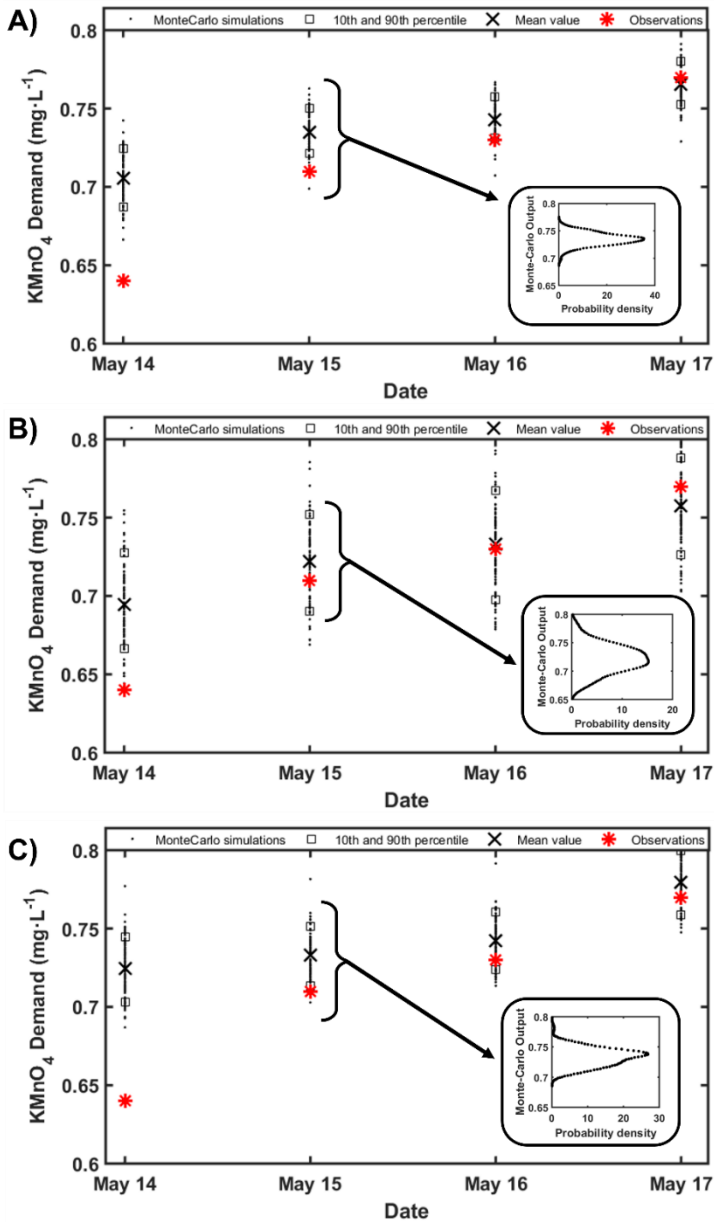
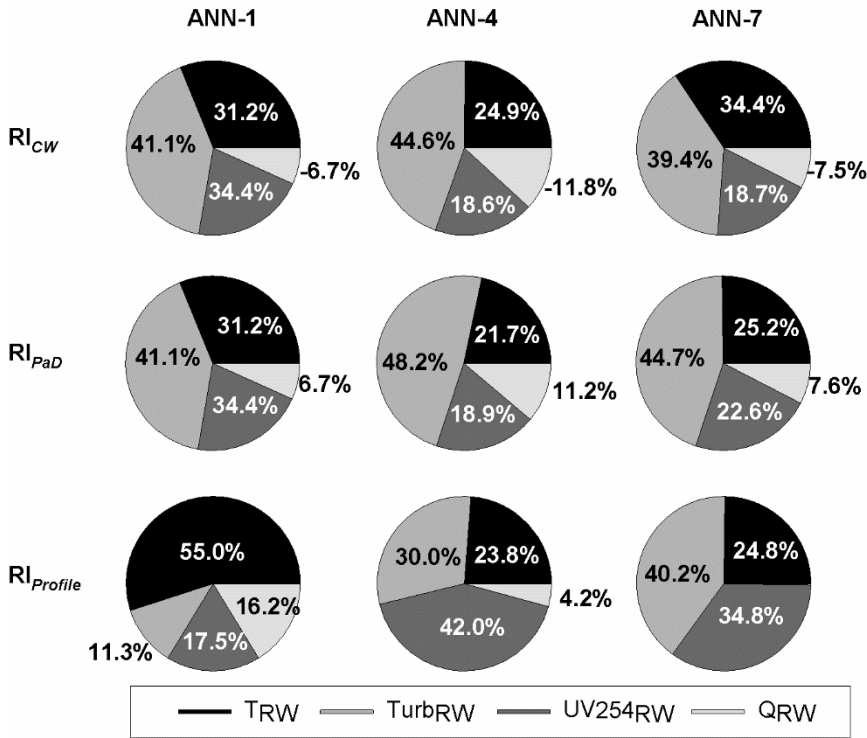

**Figure 19.** Representation of uncertainty predictions for  $\text{KMnO}_4$  demand time-series using Monte Carlo method for ANN1, ANN4 and ANN7, showing the Monte-Carlo simulation outputs, with mean value, 10th and 90th percentile, and the observed  $\text{KMnO}_4$  demand for the period 13/5/2015-16/5/2015. Probability density of Monte-Carlo outputs on one date (15th May 2015) is also shown.

In general, the extent of uncertainty in the three tested models was shown to be low. Also, there were no significant variations on the extent of uncertainty along the studied time period (e.g. variations between summer and winter periods). The smallest uncertainty was found for ANN-1, whereas it slightly increased at ANN-4 and ANN-7. Low uncertainty bounds can be due to negatively and highly correlated model parameters. The increase in the number of parameters and the better identifiability of ANN-4 and ANN-7 model parameters enlarged the uncertainty bounds and thus, providing a slightly better fit with the observed data. Due to the narrow uncertainty bands, only 8.99%, 18.43% and 12.89% of the experimental values for permanganate demand were shown to lie within the 10<sup>th</sup> and 90<sup>th</sup> percentile of MC outputs of ANN-1, ANN-4 and ANN-7 respectively.

#### 4.3.4. Sensitivity Analysis

The RI values of the four inputs selected for three models were calculated using Connection Weight, Partial Derivatives and Profile Method, and results are shown in Figure 20. The CW and PaD method illustrated the relative importance of inputs in the same order ( $Turb_{RW} > T_{RW} > UV254_{RW} > Q_{RW}$ ), whereas  $RI_{Profile}$  showed different order of importance especially in ANN-1. Turbidity is surrogate measure of sediments in water, metals, and NOM (World Health Organization, 2017) and thus is expected to be positively correlated with the permanganate demand. UV254 measure accounts for the aromatic content of dissolved organic matter. In a study conducted by Kim et al. (2018) UV254 and specific UV254 (SUVA<sub>254</sub>) were identified as the main DOM characteristics contributing to the permanganate consumption in natural waters, showing high correlation ( $R^2 = 0.95$  and  $0.96$ ). This is in alignment with the RI of UV254 in the different models, especially in ANN-1. Temperature has positive RI for all the studied models, since it has an effect on the oxidation rate constants of permanganate in natural waters (Crittenden et al., 2012; Kim et al., 2018; Rodríguez et al., 2007). Finally,  $Q_{RW}$ , which is inversely proportional to the hydraulic retention time, showed negative values of RI and was placed to the least important input variable. A sufficient contact time prevents permanganate to pass through the downstream filters and enter the distribution system (Crittenden et al., 2012), and this is why operators have to adjust the dose according to the corresponding inflow rate.



**Figure 20.** RI computed for ANN-1, ANN-4 and ANN7 models using Connection Weight and Partial Derivatives Method.

In addition to computed  $RI_{CW}$ ,  $RI_{PaD}$  and  $RI_{Profile}$ , the profile method is also reported for assessing the plausibility of the models input-output relationships. This method is suitable for visually identifying the patterns fixed by the different ANN models. Very similar response curves were found for ANN-1 and ANN-4 regarding all input variables but less plausible relationships were found for ANN-7. The profile method plots for ANN-1, ANN-4 and ANN-7 can be find in the Annex II (A2.5).

Even ANN-1 had the simplest structure, it showed the most plausible input-output relationships according to a-priori knowledge of the system. Similar findings can be seen in study conducted by Humphrey et al. (2017), where the predictive and structural performance of three different ANN models with 1, 12 and 14 nodes in the hidden layer were compared for predicting surface water turbidity. It was shown that even a MLP with one neuron had the simplest architecture (low number of parameters and architecture com, it was shown that the MLP with one node in the hidden layer (the simplest tested architecture) captured the underlying relationships between inputs and

outputs better than the larger architectures, and this was demonstrated through sensitivity analysis techniques.

#### 4.3.5. Model integration in an EDSS

For implementation of the model in the real process and allow the communication of the model outputs to the DWTP operators, models were integrated into an EDSS framework and a graphical user interface (GUI) was built. A screenshot of the developed GUI can be seen at Figure 21. The presented system is connected to the DWTP online data acquisition system and gathers real-time input data. The output of MLP-1 model and the probability distribution of Monte Carlo outputs and response of the CBR model are displayed.

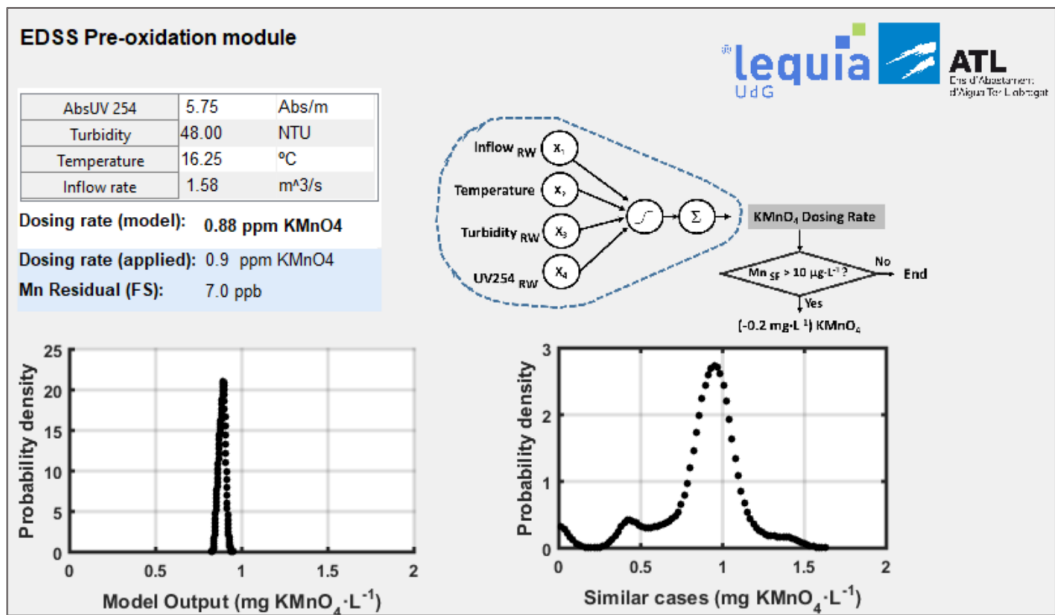

Figure 21. Graphical user interface for the EDSS

Before running the control system in a closed loop and have results of the real impact and limitations of this tool, building confidence among the users is needed. Therefore, as an initial step, the EDSS is running in parallel with the Supervisory Control and Data



Acquisition (SCADA) system and is working as open-loop control system by recommending the operational set-points. The purposed permanganate dosing rate of the predictive model is backed-up by the reporting of the uncertainty analysis and CBR-model outputs. This way, the extent of uncertainty/precision of the predictive model but also of the historical behaviour of the operators in similar cases are shown. Generally, uncertainties regarding the predictive model output were in a lesser extent than variations of the permanganate dosing according to previous similar conditions given by the CBR model. This way, the daily decision-making can be speeded-up and improved by offering consistent and robust results to the users, who can consult the model outputs at any time and according to real-time raw water characteristics and operation conditions of the plant.

Moreover, the EDSS architecture allows the addition of expert rules, which act as supervisory rules at the top of the control algorithm. It was considered necessary to add a rule for lowering the permanganate dose  $0.2 \text{ mg}\cdot\text{L}^{-1}$  in case of achieving manganese concentrations greater than  $10 \text{ }\mu\text{g}\cdot\text{L}^{-1}$  at the sand filters, to prevent potential overdosing of the chemical. The EDSS was implemented at Llobregat DWTP and was tested in January-September 2019 period. Figure 22 shows the time-series of daily average of permanganate dosing rate proposed by the predictive model versus the one applied at full-scale.

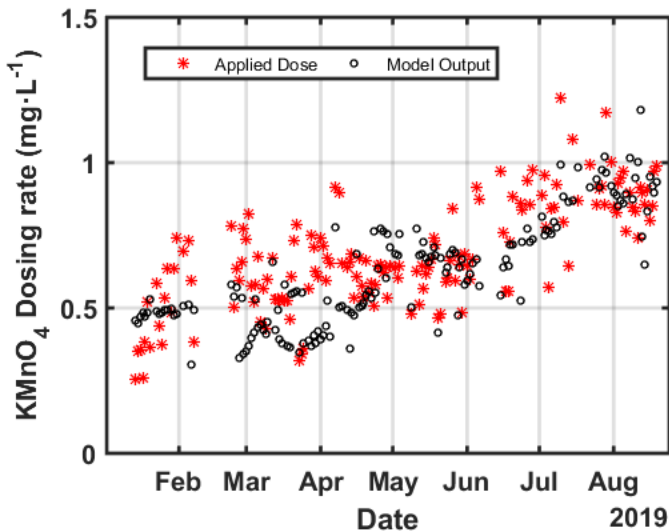

Figure 22. Results of the implementation phase of the EDSS.

During the studied period, it was up to DWTP users to apply the predicted dose or adjust it according to the actual concentration of residual manganese in water and previous experience. As a first approximation, the combination of the predictive model with the expert rule for lowering the dosing rate at high residual manganese levels was considered to be sufficiently good. It was shown that the purposed system did not lead to any overdosing of the system, especially in March-April 2019 period, in which high concentrations of residual manganese (between 10 and 20  $\mu\text{g}\cdot\text{L}^{-1}$ ) lead to propose lower dosing rates. The laboratory measurements in these cases were all within quality specifications. Excess permanganate passing through the filters has to be avoided, since it may enter the distribution system and lead to an undesirable taste in water (Crittenden et al., 2012).

After the implementation phase, it was considered that benefits from EDSS include providing a baseline operational set-points while maintaining operator's added-value expertise in the process. Modifications on the baseline set-points made by the users were recorded for the follow-up of the implementation phase. It is also expected that DWTP users will gradually build confidence on predictive model outputs and implement them more consistently. It was noted that systems like the developed EDSS may contribute to train and support those technical personnel that do not have accumulated sufficient experience to run the process, while it serves as a supporting tool for experienced users.

#### 4.4. Conclusions

An environmental decision support system to help with the multi-parametric challenge of controlling the pre-oxidation step at a full-scale DWTP was implemented. To do this, first a systematic procedure for feature selection was done, showing that potassium permanganate dose can be best predicted using temperature, turbidity, absorbance at 254nm and inflow rate as input variables. For model development purposes, multiple linear regression and multi-layer perceptron models were compared, and the best data-driven approach was shown to be a multi-layer perceptron with one node in the hidden layer.

Uncertainties on the model output resulting from model development were quantified using a Monte Carlo scheme and validated against historical data. The root squared error and  $R^2$  of the predictive model was  $0.13 \text{ mg}\cdot\text{L}^{-1}$  and 0.74 respectively, which was considered sufficiently accurate for the utility needs. In lights of integrating the predictive model in an EDSS for aiding in day-by-day operation of a full-scale DWTP, a case-based reasoning model was developed in order to support model outputs and overcome the black-box nature of the predictive model.

The MLP and CBR models were integrated in a EDSS that gathers data from online sensors and analysers and provide real-time support for daily operation. By integrating these two kinds of model, the user is informed about uncertainty in model predictions, as well as uncertainties related to previous actions with similar operating conditions recorded at the historical database. We believe that this system can increase the robustness of model predictions and allows the user to become more confident on using the EDSS for aiding in decision-making rather than being guide only by previous experience. Also, the EDSS architecture demonstrates to be adaptable to specific cases and situations out of the scope of the predictive model by the inclusion of expert rules at the supervisor level. The EDSS is currently implemented at Llobregat DWTP and has been operated as an open-loop control system for 9 months, providing the base-line permanganate dosing rate from which operators decided whether to apply it or adjust it according their experience to fit more specific cases.

## 5.Results II:

Benchmarking empirical models for THMs formation in drinking water systems and integration into an EDSS.

Redrafted from:

**Godo-Pla, L.**, Emiliano, P., Poch, M., Valero, F., Monclús, H., 2020. Benchmarking empirical models for THM formation in drinking water systems: An application for decision support in Barcelona, Spain. (Under review in *Science of the Total Environment*).



## 5.1. Background

Advanced treatments such as GAC filters or membrane technologies have been gradually incorporated at DWTPs to remove DBPs precursors and be more resilient in front of increasing stringent regulations. Regarding occurrence of DBPs in drinking water, the Spanish regulation limits the THMs concentration at  $100 \mu\text{g}\cdot\text{L}^{-1}$  in tap water (RD 140/2003).

Llobregat river is one of the main water sources of Barcelona Metropolitan Area (BMA) (NE Spain, ca. 4.5 million inhabitants). The quality issues of this Mediterranean river have been reported in several studies for the high fluctuations of salinity, natural organic matter and temperature (J. L. Fernández-Turiel et al., 2000; Raich-Montiu et al., 2014). Also, high concentrations of bromide have been found in the  $0.5 - 1.2 \text{ mg}\cdot\text{L}^{-1}$  range, leading to high concentrations of THMs with most weight on brominated species (Valero and Arbós, 2010). This issue motivated, in 2009, the upgrading of Llobregat DWTP by adding an electro dialysis reversal (EDR) step to remove DBPs precursors and improve organoleptic properties of water. After more than ten years, this technology has been proven to be a robust membrane-based technology for treating brackish water and reduce DBPs precursors. Removal of  $>75\%$  for bromide,  $>60\%$  for chloride (among other ionic species) and  $>30\%$  for TOC were observed in full-scale operation of EDR treating brackish water (Valero et al., 2013).

Membrane-based technologies like EDR are by far the most energetic-demanding process of the DWTP, and this poses a challenge for a correct management that struggles to find a balance between economic and environmental costs of operation. In order to improve the robustness of EDR management, mathematical modelling can help in predicting DBPs formation along the supply network and therefore, adjust the fraction of conventional-treated water to be blended with EDR effluent. Most of DBPs models reported in the literature are empirically modelled with log-linear power functions by regressing each one of the water quality parameters influencing DBPs formation (Amy et al., 1998; Chowdhury et al., 2009; Golfinopoulos et al., 1998; Lin et al., 2018; Platikanov et al., 2007). However, most of these studies have been done using laboratory-scale data and these conditions are different from those encountered in real water systems (Sadiq et al., 2019). On the other hand, other studies used artificial neural networks and reported a better predictive capacity of this data-driven modelling technique with better results than multivariable power functions (Kulkarni and Chellam, 2010; Rodriguez and Sérodes, 2004). Most THMs prediction models include total organic

matter (TOC), pH, hydraulic retention time (HRT), bromide (Br), UV absorbance at 254 (UV254), temperature and initial chlorine dose ( $D_{Cl}$ ) as input variables parameters. These variables are suitable for their representativeness on DBPs formation but also because they are easy to measure in real-time (Rivadeneira et al., 2014). Predictive models have been used in the water and wastewater treatment field for improving process control in Environmental Decision Support Systems (EDSSs) for automated decision-making in full-scale facilities (Corominas et al., 2017). A recent review of DBPs models in Sadiq et al. (2019) concluded that there is still a significant scope to improve the feasibility of using these models for operational purposes, and outlined the need for reducing uncertainties related to model development and to integrate various modelling techniques, among others.

The goal of this study is to develop an EDSS to help in EDR management in a case-study DWTP by keeping THMs concentrations under some user-defined operational thresholds along the supply network in a real-time basis. To face this complex system, the objectives of the present study are 1) To characterise the full-scale removal performance of EDR on main DBPs precursors, 2) To benchmark existing THMs models using field-scale data of Llobregat DWTP, and 3) To integrate process knowledge to the calibrated models to provide real-time support for EDR management. This should be in favour of a better operational control during water treatment process in complex water systems such as Mediterranean catchment of BMA.

## 5.2. Methodology

### 5.2.1. Case study

Water was characterised at the outlet of Llobregat DWTP and THMs concentrations were measured at different points of the distribution network to have samples describing seasonal variations in water quality and operational changes, including different HRTs. Main characteristics are summarised in Table 5.

**Table 5.** Characterization of water collected at Llobregat DWTP effluent and different locations along the supply network (Period March 2019 – March 2020), n=573.

Parameter	Units	Mean $\pm$ Std	10 <sup>th</sup> Percentile	90 <sup>th</sup> Percentile
UV254	cm <sup>-1</sup>	2.03e-2 $\pm$ 5.6e-3	1.40e-2	2.78e-2
TOC	mg·L <sup>-1</sup>	1.21 $\pm$ 3.4e-1	0.81	1.69
HRT <sub>ST</sub>	h	11.60 $\pm$ 21.2	0.00	46.40
Temperature	°C	17.45 $\pm$ 4.9	11.28	25.00
pH	-	7.45 $\pm$ 1.9e-1	7.22	7.72
Bromides	mg·L <sup>-1</sup>	0.36 $\pm$ 1.3e-1	0.22	0.51
D <sub>Cl</sub>	mg·L <sup>-1</sup>	1.21 $\pm$ 6.3e-2	1.13	1.29
THMs	µg·L <sup>-1</sup>	19.52 $\pm$ 20.0	0.00	46.92

The hydraulic retention time of water in pipes of the distribution network can have high fluctuations and Llobregat DWTP must adapt its effluent water quality to ensure THMs will stay in a tolerable range. The ratio of water treated by EDR ( $X_{EDR}$ ) is the most relevant operational parameter regarding this issue.

### 5.2.2. Modelling framework

Among the different techniques reviewed in the literature (Chowdhury et al., 2009; Sadiq et al., 2019; Sadiq and Rodriguez, 2004), the majority of predictive models for DBPs have been based on statistical regression and (most recently) artificial neural networks. Therefore, log-linear power functions and multi-layer perceptrons (MLPs) were selected for mathematical model benchmarking, and calibration and validation procedures were applied to field-scale data of Llobregat DWTP. The organic content of water (measurable



through TOC and UV254), pH, Temperature, HRT, bromide ion and free residual chlorine were selected as physically meaningful input variables, and also because the easiness of online monitoring.

The MLR model was fitted following eq. (1):

$$[THM] = a \cdot ([UV254]+1)^b \cdot [TOC]^c \cdot [DCl]^d \cdot ([Br]+1)^e \cdot T^f \cdot pH^g \cdot HRT^h \quad (\text{eq. 10})$$

where  $a, b, c, d, e, f, g$  and  $h$  are empirical constants to be estimated by a comprehensive parameter estimation procedure at each model.

An MLP is composed by an input layer, one or more hidden layers with nonlinear activation functions and an output layer. For means of comparison the same kind of MLPs described in Kulkarni and Chellam (2010) were tested, that consists of feed forward, back propagation MLPs with one or two hidden layers. Different architectures with 4-8 nodes in the hidden layers were tested. Referring to the MLP architecture, models were named  $MLP_{ij}$  where  $i$  and  $j$  are the numbers of nodes in the first and second hidden layer, respectively. Therefore, a total number of 30 MLPs were tested.

With the aim of building physically meaningful models, a synthetic sample was generated for each observation at time  $HRT=0$  h, assuming that the initial concentration at the instant of chlorination was  $0 \mu\text{g}\cdot\text{L}^{-1}$ . These samples were included in the dataset for training MLP models, but were excluded for calculating performance metrics at the validation of models.

### 5.2.3. Benchmarking of models

The presence of outliers is expected when dealing with full-scale data due to non-ideal experimental conditions. Some factors affecting to this include the status of pipes, re-chlorination along the distribution network and others. Therefore, a systematic outlier detection and removal estimation procedures were followed before comprehensive parameter of predictive models (Frutiger et al., 2015). In the present study, the upper extreme values are of importance in the context of assessing regulatory compliance with DBPs exposure. Therefore, only lower extreme values were removed from the original dataset.

First, data was fitted with a robust regression method using MLR model. Data-points below 2.5<sup>th</sup> and 97.5<sup>th</sup> percentiles of errors ( $\epsilon$ ) between observed and predicted values

were marked as outliers and removed from the original dataset. After this, the dataset was divided into calibration (80%) and validation (20%) datasets to avoid overfitting of the models using a self-organising map with *selforgmap()* function. This method ensures that data is divided in a way that calibration and validation datasets have similar statistical properties.

Calibration dataset was used for MLR and MLPs models calibration. Bootstrapping method was applied for parameter estimation of MLR and for obtaining a distribution of parameter estimators  $\hat{\theta}$ . MATLAB® Neural network Toolbox was used for MLPs calibration.

A first validation of the models was done by assessing R-squared and the mean absolute error (MAE) of the model predictions versus observed values of THMs for the calibration and validation dataset. A good predictive model is the one that balances good performance on the dataset which was used for calibration on the model (replicative validation) and also on data that was not seen during model development (predictive validation) (Humphrey et al., 2017). A first set of models were selected according to this criterion. After that, Other methods aimed to check that the model input-output relationships were in accordance with the a-priori knowledge of the process were applied. The profile method has been used for structural validation of artificial neural networks, since it allows a visual interpretation of each input effects on the output variable, by fixing the remaining variables at different percentiles (Godo-Pla et al., 2019; Humphrey et al., 2017). This method was used to select the most adequate model among the previously selected ones.

#### 5.2.4. Model Validation

Extensive validation procedures were considered necessary to ensure good adequacy of the model with the real system requirements and build confidence among users. Sensitivity analysis can determine the relative contributions of water quality and operational factors in DBPs formation. A sensitivity analysis technique based on differential analysis was used on the selected model to rank the contribution of inputs on the output. This was done with an aggregated dynamic sensitivity function as the delta mean-squared ( $\delta_i^{msqr}$ ). This relative sensitivity functions is non-dimensional with respect to units and can be used to compare the effects of model inputs among each other (Sin and Gerbaey, 2016). The first order derivative of the model in respect of each

input parameter  $i$  is evaluated at a nominal value of input variables to calculate absolute sensitivity ( $sa_i$ ) and the non-dimensional sensitivity function ( $sr_i$ ) indices:

$$sa_i = \frac{f(x_i^0 + \Delta x_i) - f(x_i^0)}{\Delta x_i} \quad (\text{eq. 11})$$

$$sr_i = sa_i \cdot \frac{y^0}{x_i^0} \quad (\text{eq. 12})$$

where  $f(x^0)$  is the model function evaluated at the nominal values of input parameters  $x_i^0$ ,  $\Delta x$  is the perturbation step (with a perturbation factor  $\varepsilon = 10^{-3}$ ), and  $y^0$  is the nominal value of the output variable. Lastly, for  $sr_i = 1 \dots N$  values,  $\delta_i^{msqr}$  is defined as:

$$\delta_i^{msqr} = \sqrt{\frac{1}{T} \cdot \sum_{t=1}^T sr_i(t)^2} \quad (\text{eq. 13})$$

Further details on the methodological procedures of sensitivity analysis can be found in the literature (Brun et al., 2001; Sin et al., 2009).

## 5.3. Results and Discussion

### 5.3.1. EDR performance characterisation

Operational data from EDR sampling campaigns was collected from 2011 to 2017, resulting in a dataset of 220 samples including seasonal variations of raw water quality. Main parameters affecting The removals of TOC and Bromides in EDR were modelled as regression of temperature, which ranged from, 2 to 26 °C. EDR technology at DWTP Llobregat is programmed to apply higher tensions as temperature of water increases, thus favouring a greater DBPs precursor removal with higher temperatures. A part from this, temperature by itself increases the diffusivity of ions through the ionic exchange membranes and therefore, has a positive effect on EDR removal on different compounds. Eq (5), (6) and (7) show the equations derived from the linear regression:

$$\text{Bromide removal (\%)} = 62.15 + 0.98 \cdot T_{CT} \quad (\text{eq. 14})$$

$$\text{TOC removal (\%)} = 15.36 + 0.98 \cdot T_{CT} \quad (\text{eq. 15})$$

$$\text{UV254 removal (\%)} = 22.50 + 1.63 \cdot T_{CT} \quad (\text{eq. 16})$$

Where  $T_{CT}$  is the temperature of conventional treated water. R-Squared values of eq. (5), (6) and (7) were 0.90, 0.66 and 0.81, respectively. It is expected that negatively-charged humic fractions of NOM would show higher correlation than TOC in EDR removal. Since this study targets the implementation of algorithms using online available measures, the R-squared values found for THMs precursors removal were considered sufficiently accurate for the utility needs.

### 5.3.2. Benchmark of THMs formation models

After removing outliers, dataset was divided into calibration (80%) and validation (20%) datasets and the model candidates were fitted using the calibration dataset. For cross-validation purposes, the performance of all tested models (MLR and MLPs) on calibration and validation dataset in terms of correlation coefficient ( $R^2$ ) were evaluated and are shown in Figure 23.

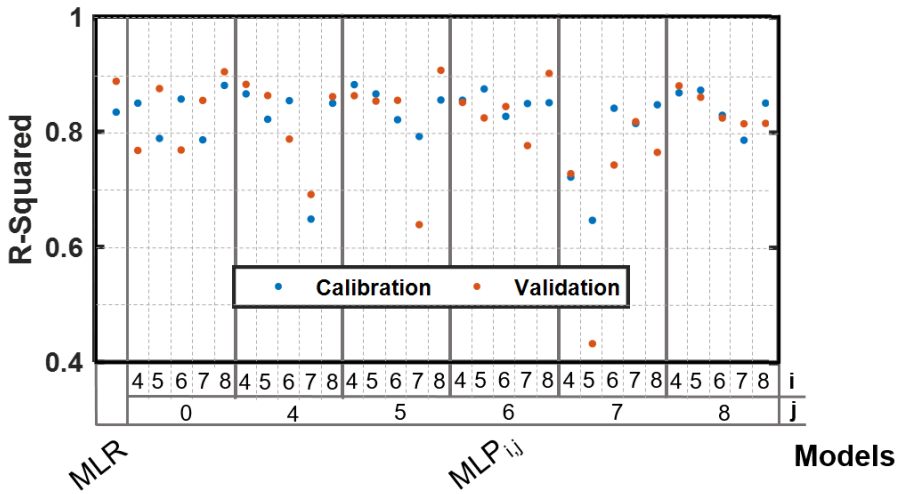

**Figure 23.** Replicative and predictive assessment of MLR and  $MLP_{ij}$  models, where  $i$  is the number of nodes in the first hidden layer and  $j$  the number of nodes in the second hidden layer.

Based on the cross-validation statistics, a first selection of models was done targeting the models showing the best balance between replicative and predictive abilities. It can be seen that MLR showed high and very similar R-squared values for both calibration and validation dataset. On the other hand, MLPs also showed very good performance with R-squared statistic of most of the models above 0.80. In the case of MLPs with one hidden layer, increasing model complexity by adding nodes (from 4 to 8) resulted in an overall performance increase of the model predictive abilities. On the other hand, possibly because of overfitting the model, the same was not observed in the MLPs architectures containing two hidden layers. The addition of a second layer and the increase of the number of nodes in them did not result in a consistent improvement on the model’s replicative and predictive performance.

Therefore, 4 out of the 31 models tested were selected based on their performance in the validation dataset: MLR,  $MLP_8$ ,  $MLP_{8,5}$  and  $MLP_{8,6}$ . Table 6 shows the main performance statistics of these models.

**Table 6.** Main performance statistics of pre-selected models.

Model	Calibration		Validation	
	R <sup>2</sup>	MAE ( $\mu\text{g}\cdot\text{L}^{-1}$ )	R <sup>2</sup>	MAE ( $\mu\text{g}\cdot\text{L}^{-1}$ )
MLR	0.834	4.21	0.888	4.00
MLP <sub>8</sub>	0.880	3.23	0.904	3.29
MLP <sub>8,5</sub>	0.855	3.53	0.907	3.13
MLP <sub>8,6</sub>	0.850	3.68	0.901	3.21

According to the treatment manager of Llobregat DWTP, an error of  $\pm 5 \mu\text{g}\cdot\text{L}^{-1}$  and good correlation with historical data (>80%) would be acceptable for using this model at the decision-support level at the full-scale plant. All models in Table 6 showed very good performances with R-squared values above 0.80 and MAE below  $5 \mu\text{g}\cdot\text{L}^{-1}$  in both calibration and validation dataset. Hence, all the described models would be candidates fulfilling this criterion.

To tip the balance among these pre-selected models, the profile method was applied for identifying patterns and assessing the plausibility between input-output relationships of the models. This method allows to check whether a mathematical model behaves in accordance to the a-priori knowledge of the process or not, in a visual manner. Figure 24 shows the high differences between the pre-selected models regarding the HRT profile plot.

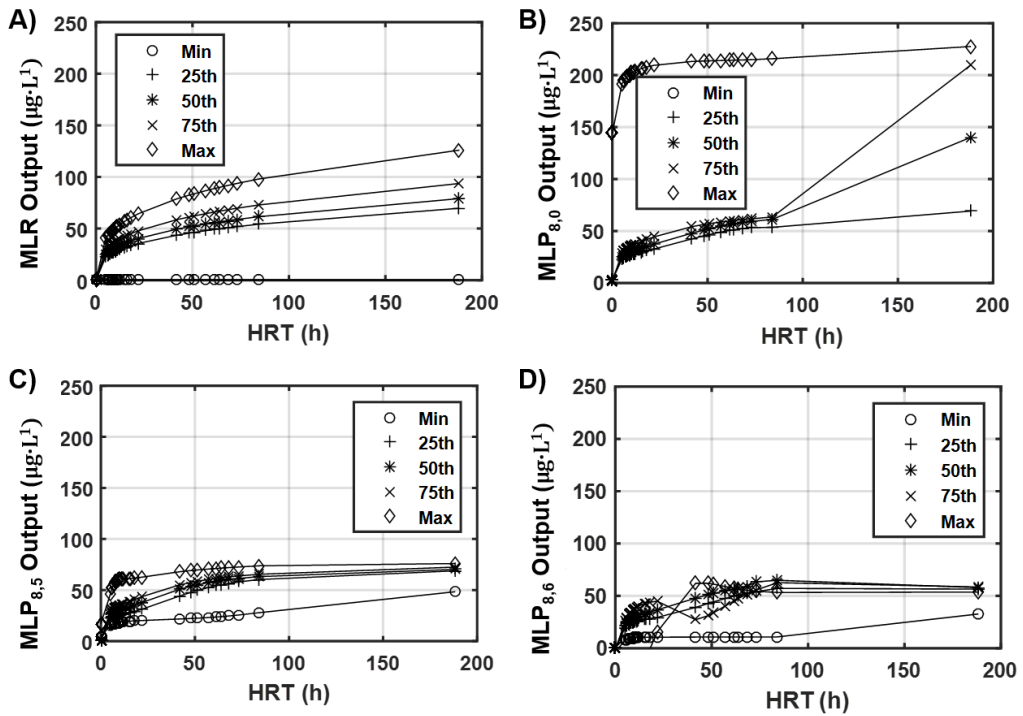

**Figure 24.** Profile method plots of the pre-selected models considering HRT as input variable: A) MLR; B) MLP<sub>8,0</sub>; C) MLP<sub>8,5</sub>; D) MLP<sub>8,6</sub>. n=573.

Profile curves of MLR were the most plausible among the tested models. It can be withdrawn that in this case, an increase in model complexity did not result in better (or expected) input-output relationships. The complexity and nonlinearities found in the different tested MLP architectures led to sinuous profiles plots, whereas the exponential model showed clearer relationships between inputs and output of the model. Differences on these models highlight the need of adequately assessing the structural validity of data-driven models. The profile method plots for the other input variables of MLR model can be find in the Annex III (A3.1).

### 5.3.3. Model Validation

Sensitivity analysis was performed on the obtained parameters of MLR model. The main characteristics of parameter estimators and  $\delta^{\text{msqr}}$  is shown in Table 7.

**Table 7.** Parameter estimators of THM predictive model and delta-mean-squared.

Parameter	Mean	St. Dev.	$\delta^{\text{msqr}}$
<b>a</b>	6.18E+00	1.00E+00	1.72E+00
<b>b</b>	3.64E+00	1.59E+00	1.26E-01
<b>c</b>	4.62E-01	3.01E-02	1.58E-01
<b>d</b>	4.20E-01	1.09E-01	1.37E-01
<b>e</b>	4.71E-01	5.59E-02	2.51E-01
<b>f</b>	1.69E-01	2.71E-02	8.30E-01
<b>g</b>	4.84E-02	6.44E-02	1.67E-01
<b>h</b>	2.98E-01	6.13E-03	1.26E+00

Table 7 shows that there was no identifiability issues during parameter estimation, except for parameter *g* (corresponding to pH effect). This issue with the pH-related parameter can be due to the low variability of pH at the full-scale system, leading to a less statistical significance of this parameter.  $\delta^{\text{msqr}}$  values were used as a non-dimensional sensibility measure for assessing the contribution of model parameters to the output variance. Hence the model parameters can be ranked according to  $\delta^{\text{msqr}}$ , to compare the importance of input factors. According to these values, the most important parameters were *a*, *f* and *e*. These three parameters are related to a constant value (with no physical meaning), and to the bromide and temperature terms in eq (10), respectively. Other studies revealed organic matter as the most important factor for DBPs predictions Kulkarni and Chellam (2010). The obtained results suggest that salinity and temperature are the most influential factors to take into account for DBPs control in Llobregat DWTP. This quality issues are related mining activities of large salt deposits in the upper part of the basin and also related to the Mediterranean climate (J. L. Fernández-Turiel et al., 2000). It is also worth-noting that this study is focused in the DWTP effluent water, where most of NOM has been removed after the conventional and advanced treatment at Llobregat DWTP.



In order to visually check the model fit with historical data, a time-series plot of THMs concentrations and MLR outputs is shown in Figure 25.

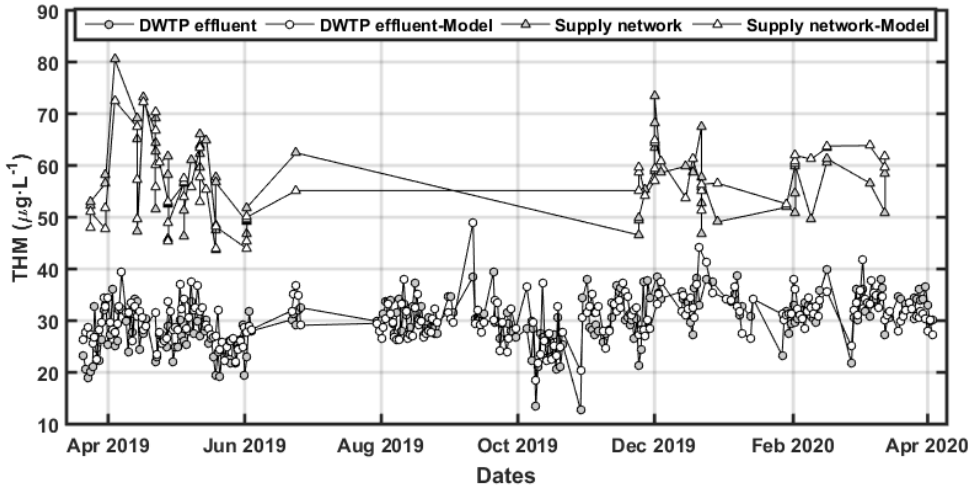

**Figure 25.** Time series of observed vs model output values of MLR model for samples collected at the DWTP effluent and at the distribution network. N=315.

It was shown that the model performed well during the tested period independently from the time of the year, but also from the measured range (no error differences between low- and high-measured values). The high difference of THMs values were due to the sampling of different points at the distribution network with different HRTs.

#### 5.3.4. Environmental decision support system

Taking into account the ATL's supply network characteristics, two critical points (CP1 and CP2) with the largest HRTs were selected as indicators for good EDR management. These points correspond to the farthest points where Llobregat DWTP can supply water, depending on ATL distribution network strategy. Representative HRT values for CP1 and CP2 were considered for model predictions, being 48 and 96 h, respectively. A lower- and upper-operational value (LOV and UOV) were defined using expert criterion at 70 and 90  $\mu\text{g}\cdot\text{L}^{-1}$  respectively, to assess the THMs formation risk at the two critical points. These two values orientate DWTP managers toward a close monitoring or to take corrective measures while THMs concentration is still below the regulation limit (100  $\mu\text{g}\cdot\text{L}^{-1}$ ). The predicted THMs concentration at CP1 and CP2 was calculated through a

Monte Carlo scheme using the joint multivariate distribution of model parameters obtained in during model calibration. This allowed the quantification of uncertainty related to the predictive model development.

Two different water quality scenarios were assessed. Input variables were fixed at their 10<sup>th</sup> and 90<sup>th</sup> percentile of their historical values (conventional treatment effluent) for scenario 1 and scenario 2, respectively, in order to be representative from high and low quality water cases. The expected THMs concentration at CP1 and CP2 with Scenario 1 with different EDR operational conditions ( $X_{EDR}=0\%$ , 50% and 100%) is shown in Figure 26.

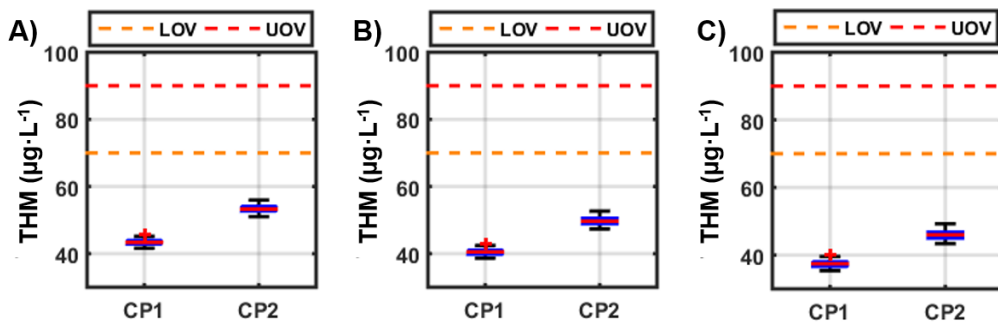

**Figure 26.** Boxplots indicating the Monte Carlo outputs of MLR at two critical points (CP1 and CP2) when input variables are at the 10th percentile of their historical values. The lines of the plot indicate the 25h, 50th and 75th percentile, and whiskers indicate the extreme values. A)  $X_{EDR}=0\%$ ; B)  $X_{EDR}=50\%$ ; C)  $X_{EDR}=100\%$ ; LOV: Lower operational value; UOV: Upper operational value.

Under high quality raw water conditions, the expected THMs concentrations at the two critical points (CP1 and CP2) would be below LOV ( $70 \mu\text{g}\cdot\text{L}^{-1}$ ). Therefore, DBPs concentration would be under acceptable levels and EDR treatment would not be necessary for DBPs precursor removal, even this treatment would also favour the organoleptic properties of water.

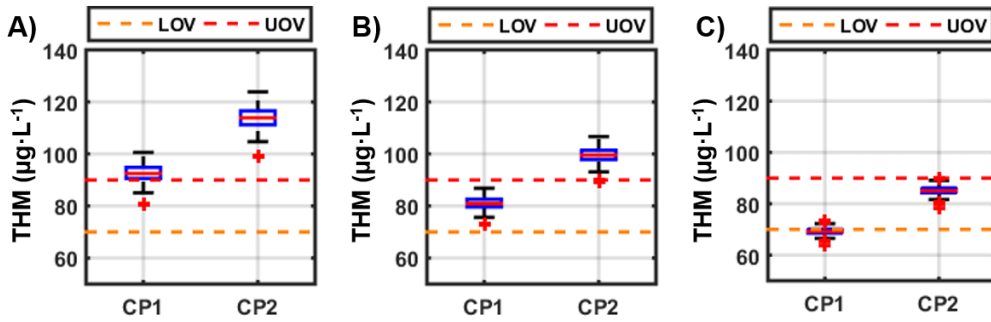
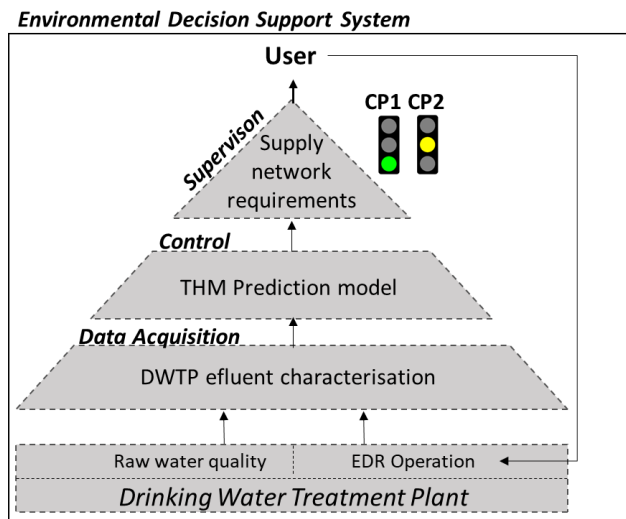

**Figure 27.** Boxplots indicating the Monte Carlo outputs of MLR at two critical points (CP1 and CP2) when input variables are at the 90th percentile of their historical values. The lines of the plot indicate the 25th, 50th and 75th percentile, and whiskers indicate the extreme values. A)  $X_{\text{EDR}}=0\%$ ; B)  $X_{\text{EDR}}=50\%$ ; C)  $X_{\text{EDR}}=100\%$ ; LOV: Lower operational value; UOV: Upper operational value.

Figure 27 shows the THMs formation of raw water quality depicted in scenario 2. It can be seen from the Monte Carlo outputs distribution in Figure 6.A that about 75% and 100% of model predictions would be above UOV for CP1 and CP2 respectively, when water is only treated by conventional treatment ( $X_{\text{EDR}}=0\%$ ). Additionally, CP2 would be even above the regulation limit ( $100 \mu\text{g}\cdot\text{L}^{-1}$ ). Therefore, in the low water quality case, the need of an advanced treatment is deemed necessary to fulfil the quality standards at both critical points. As expected, an increase of  $X_{\text{EDR}}$  led to lower DBPs precursors concentration and therefore, to a reduction on the predicted THMs values in both CP1 and CP2, but to different degrees. A mid degree of EDR treatment ( $X_{\text{EDR}}=50\%$ ) would benefit from delivering water at tolerable levels (between LOV and UOV) at CP1, but CP2 would keep above UOV. Under these circumstances, the highest EDR treatment ( $X_{\text{EDR}}=100\%$ ) would permit to deliver water below LOV at CP1 in about 75% of the model predictions and at tolerable range (between LOV and UOV) at CP2 in 100% of the cases. Given these results, and to ensure quality of water at CP2, other strategies like mixing Llobregat DWTP effluent with other water sources containing less DBPs precursors and therefore, making dilution effect on DBPs concentrations could be contemplated.

To communicate results with the user, a key performance indicator in form of a traffic light was built for CP1 and CP2. A green colour of the traffic light corresponded to 50<sup>th</sup> of predicted THMs (50<sup>th</sup> percentile) being below LOV. The yellow light was assigned when the 50<sup>th</sup> percentile of predicted THMs were between LOV and UOV, indicating that process monitoring should be enhanced at this point. Finally, a red colour would appear when 50<sup>th</sup> percentile of predicted THMs are above the UOV, indicating that corrective

measures should be taken to lower down the THMs at the analysed critical point. In the present case, corrective measures include: Increase the EDR ratio at the advanced treatment ( $X_{EDR}$ ), improve the organic matter removal at the conventional treatment, reduce the HRT at the distribution network or mixing Llobregat DWTP effluent water with other water sources with less DBPs precursors. The final aim of the EDSS is to achieve the maximal sustainability by balancing the environmental, economic, and health effects of the advanced treatment management at Llobregat DWTP. The proposed EDSS flow scheme is shown in Figure 28.



**Figure 28.** Flow scheme of EDSS

The proposed system allows to communicate the effects of the DWTP operational conditions on the DBPs formation depending on raw water quality, including uncertainties related to model predictions. The operation of the supply network depends on multiple factors such as the availability of water sources, water demand, and maintenance works. The EDSS can help in the daily-decision making of the plant for an adequate operation, responding to influent water quality variations and network requirements. The need for choosing different critical point was confirmed, since they might require different degrees of treatment.

## 5.4. Conclusions

In this study, the formation of trihalomethanes (THMs) was empirically modelled for managing the advanced treatment process of a full-scale DWTP. To this end, several mathematical models reported in the literature were evaluated and compared, using online-available parameters as input variables. These models included a multiple linear regressions (MLR) and multi-layer perceptrons with one and two hidden layers. Models performing best predictive validation were selected for further analysis, and finally the MLR model was chosen because its greater ability to describe the best input-output relationships and better extrapolation, especially regarding the hydraulic retention time component. The selected model exhibited good fit with the validation data set ( $R^2= 0.88$  and  $MAE= 4.0 \mu\text{g}\cdot\text{L}^{-1}$ ) and was incorporated into an environmental decision support system for managing the EDR. Two points of the DWTP distribution network were selected as critical points to assess THMs formation. The developed model enabled to communicate the uncertainty of model predictions and classify the expected THMs concentration at these points according to thresholds established by the DWTP managers. This study explores the use of predictive models and makes a step forward into the integrated management of complex drinking water distribution networks which can face important changes in raw water quality in short time periods.

## 6.Results III.

Control of primary disinfection in a drinking water treatment plant based on a fuzzy inference system.

Redrafted from:

**Godó-Pla, L.**, Rodríguez, J.J., Suquet, J., Emiliano, P., Valero, F., Poch, M., Monclús, H., 2020. Control of primary disinfection in a drinking water treatment plant based on a fuzzy inference system. *Process Saf. Environ. Prot.* 145, 63–70.  
<https://doi.org/10.1016/j.psep.2020.07.037>



## 6.1. Background

Primary disinfection occurs early in the water treatment process and provides the first chemical barrier against microbial pathogens at DWTPs. At the operation level, while maintaining an effective disinfection has the highest priority and should not be compromised, it is also important to minimize the formation of DBPs at the DWTP and supply systems. Strategies for the control of DBPs in DWTPs includes removing the precursors of DBPs, utilizing alternative disinfectants and/or removing DBPs after its formation (World Health Organization, 2017). Regarding the disinfection process, alternative chemicals such as chlorine dioxide, potassium permanganate and advanced oxidation processes have replaced chlorine at the inlet of many DWTPs to avoid the formation of THMs (Hu et al., 2018; Sillanpää et al., 2018). While primary disinfection is operated as a first barrier against pathogens and to prevent the microbial growth along the treatment train, secondary disinfection ensures that water has a minimum disinfectant along the supply system. Therefore, different chemicals can be used for primary and secondary disinfection process.

One approach that has been used in Ter DWTP (located near Barcelona, NE Spain) for the primary disinfection is the combined dosing of sodium hypochlorite and chlorine dioxide. There are published reports from laboratory tests that reveal synergistic benefits from using two or more disinfectants, i.e. the overall inactivation is greater than the sum of the inactivation achieved for each disinfectant individually (World Health Organization, 2004). This fact supports that chlorine dioxide and sodium hypochlorite can be dosed in conjunction to maintain and/or improve the disinfection efficiency and reduce THMs formation (Chowdhury et al., 2009; Yang et al., 2013) by adjusting the contribution of free chlorine to the overall disinfection.

Mediterranean regions are characterised by having strong variations in surface water quality and quantity, and they are affected by the degradation trend of drinking quality under global change (Delpla et al., 2009). In this framework, the evaluation of the DBPs formation in a consistent manner is needed. The adoption of digital solutions in operating DWTPs and the development of advanced control systems using Artificial Intelligence (AI) aims to optimise the workforce (including decreasing the need for emergency call-outs), ensure regulatory compliance and increase the resilience of a facility for a changing environment (Makropoulos, 2019; Sarni et al., 2019).



Knowledge-based models such as fuzzy inference systems (FISs) are modelling techniques that become suitable for consolidating the process engineering knowledge gained from experience and observations with operating a certain system (Kelly et al., 2013). In the environmental domain, these systems have been used in the water and wastewater treatment field to improve process control and can be incorporated into EDSSs for automated decision-making in full-scale facilities (Corominas et al., 2017). FISs have been used in drinking water treatment to predict coagulant dose from raw water characteristics (Lamrini et al., 2014) or to support the selection of disinfectants at DWTPs (Chowdhury et al., 2007).

The objective of this study is to develop a control system based on FIS that combines the available data, scientific theory and expert opinion to predict the mixed oxidants dose for the primary disinfection in a full-scale DWTP. The purposed strategy aims to control the DBPs formation in terms of THMs, chlorites and chlorates using real-time data from commercially available sensors.

## 6.2. Methodology

### 6.2.1. Case study

The control system has been developed and implemented in Ter DWTP. Primary and secondary disinfection have an important influence on DBPs formation. Primary disinfection is done as a first microbial barrier and to prevent growth along the treatment train, and secondary disinfection ensures that water has a minimum disinfectant residual along the supply system. To ensure the microbiological safety of water and to avoid recontamination along the supply network, secondary disinfection at Ter DWTP is operated targeting a  $Cl_{free}$  of  $1.0 \text{ mg}\cdot\text{L}^{-1}$ . Thus, regarding the disinfection processes, DBPs formation is mainly controlled at the primary disinfection by adjusting the dosing rate of sodium hypochlorite ( $NaOCl_{Dose}$ ) and of chlorine dioxide ( $ClO_{2\text{Dose}}$ ).

Raw water presents quality variations related to seasonal and year-to-year fluctuations in the reservoirs, and main characteristics are summarised in Table 8. The fluorescent dissolved organic matter at raw water ( $fDOM_{RW}$ ) was measured by means of an EXO 2 fDOM smart sensor (YSI, USA). Electrical conductivity (EC) was measured with an electrical conductivity meter (Multimeter MM41, Crison, Hach-Lange, Spain). Turbidity was measured by means of Hach 2100 NTurbidimeter (Hach-Lange, Germany). UV Absorbance at 254 nm ( $UVA_{254\text{ RW}}$ ) was measured with an 8453 UV-vis Spectrophotometer (Agilent, USA). Free chlorine at the mixing chamber ( $Cl_{free\text{ MC}}$ ) was measured using a colorimetric chlorine online analyser CL17 (Hach Lange, Germany). The presence of chlorine dioxide has positive interference on this measure and therefore, the free chlorine reading is used to assess the combined dosing of sodium hypochlorite and chlorine dioxide. THMs concentrations at the storage tanks ( $THM_{ST}$ ) was monitored with THM-100 online analyser (Aqua Metrology Systems, USA).

**Table 8.** Main characteristics of Ter DWTP influent and operation conditions. (31/1/2019 - 31/11/2019, n=359).

Parameter	Units	Mean $\pm$ Std	10 <sup>th</sup> Percentile	90 <sup>th</sup> Percentile
$Q_{RW}$	$m^3 \cdot s^{-1}$	$4.81 \pm 1.51$	3.05	6.85
$Temp_{RW}$	$^{\circ}C$	$12.4 \pm 2.1$	9.9	15.3
$fDOM_{RW}$	mmHg	$27.90 \pm 8.21$	18.82	37.00
$EC_{RW}$	$\mu S \cdot cm^{-1}$	$364 \pm 35$	326	407
$Turb_{RW}$	NTU	$28.6 \pm 42.4$	1.0	99.0
$UVA254_{RW}$	$m^{-1}$	$6.66 \pm 0.72$	5.83	7.48

$Q_{RW}$ : Inflow rate;  $Temp_{RW}$ : Raw water temperature;  $fDOM_{RW}$ : Raw water fluorescent dissolved organic matter;  $EC_{RW}$ : Raw water conductivity;  $Turb_{RW}$ : Raw water turbidity;  $UVA254_{RW}$ : Raw water UV absorbance at 254 nm.

### 6.2.2. Fuzzy inference systems

FISs are an AI modelling technique that uses the available process knowledge to build a set of rules using fuzzy logic, emulating the human decision-making process. Mamdani's fuzzy inference method (Mamdani and Assilian, 1999) was chosen to develop the FIS algorithm with the Fuzzy Logic Designer Toolbox in MATLAB 2015b (Mathworks®, USA). The main parts of this algorithm are: 1) Fuzzification of input variables, where fuzzy sets of inputs are represented by membership functions; 2) Rules, where fuzzy if-then "rules" between input and output variables' attributes are defined on the basis of expert knowledge, and 3) Defuzzification, where the fuzzy output variable is transformed to a crisp output. FIS can incorporate high-level expertise to aid in problem solving. Moreover, it can represent imprecision related to human classification by means of fuzzy inference engines.

### 6.2.3. Design of the environmental decision support System

EDSS are tools designed to aid in daily decision making. These kind of structures allows the integration of different mathematical models (physical/mechanistic models,

statistical, AI) to describe a specific problem, and have been extensively used in the water treatment field (Raseman et al., 2017). The methodology and architecture for building EDSS followed in this study can be found in Poch et al. (2004), which consists in three levels, named: Data acquisition level, Control level and Supervisor level. MATLAB R2015a was used for developing the graphical user interface to allow the communication of EDSS results to the users and for validation purposes. The EDSS development included various stages such as problem formulation, knowledge elicitation, model selection and design of the validation and implementation phase. These tasks were performed collaboratively between academics and the Research, Development and Innovation (RDi) and Operation Departments of the case study DWTP. This work aimed to incorporate the interests, incentives and pressures from the different stake-holders involved in this process and to foster a successful application of the tool (Rieger and Olsson, 2012). A description of the three levels composing the proposed EDSS is described at the following sub-sections.

#### 6.2.3.1. Data acquisition level.

The data acquisition level gathers data from the SCADA of the DWTP and is responsible for the inputs for the control and supervisor levels. The values used in the algorithms correspond to instantaneous readings from online sensors and analysers, except for the Total Organic Carbon at raw water ( $TOC_{RW}$ ), which is estimated using a multiple linear regression. Dissolved organic matter fluorescence is demonstrated to correlate with TOC concentration (Baker et al., 2008). To estimate  $TOC_{RW}$  in real-time, a linear regression of analytical values with  $fDOM_{RW}$  (including an interaction term with  $T_{RW}$ ) was performed, as shown in Eq. (1):

$$TOC_{RW} = k_1 \cdot fDOM_{RW} + k_2 \cdot fDOM_{RW} \cdot T_{RW} \quad (\text{eq. 17})$$

where  $k_1$  and  $k_2$  are model parameters estimated by a least squares method ( $R^2=0.78$ ,  $N=376$ ). The high correlation indicates that  $fDOM_{TW}$  and  $T_{RW}$  are suitable for predicting  $TOC_{RW}$  for the studied water. Data used for this regression is shown in the Annex IV (A4.1).

### 6.2.3.2. Control level

Primary disinfection at Ter DWTP is controlled by fixing  $\text{ClO}_2$  Dose and  $\text{Cl}_{\text{free,MC}}$ . For the design of the EDSS, several factors regarding the formation of DBPs have to be considered, which play a role in the daily decision-making of the plant. THMs formation risk (THMFR) can be assessed with the quality of raw water, operational parameters and environmental conditions (Chowdhury et al., 2009).

Regarding the raw water quality influence on THMFR, quality parameters related to NOM and bromide concentration can be monitored. These substances react with chlorine and chlorine dioxide to produce DBPs. At the present study,  $\text{TOC}_{\text{RW}}$  was used as bulk property influencing DBPs formation in drinking water (Delpla et al., 2009; Suquet et al., 2020) since there was no presence of bromide or other inorganic substances affecting DBPs formation at Ter DWTP raw water.

pH and  $\text{HRT}_{\text{ST}}$  are the main manipulated variables that influence DBPs formation at Ter DWTP. Carbon dioxide is dosed at the inlet of the plant targeting a pH of water at 7.7. As a consequence,  $\text{HRT}_{\text{ST}}$  was the only variable taken into account when assessing THMFR, and it depends on the daily water demand. Last,  $T_{\text{RW}}$  accounts for the main environmental conditions affecting THMs formation. Apart from the seasonal variations,  $T_{\text{RW}}$  also depends on the depth in which raw water is taken from the reservoir (different catchment heights can be selected), and can have periodic variations with the aim to look for the best source water quality.

### 6.2.3.3. Supervisor level

The supervisor level acts at the top of the EDSS actions and can incorporate several rules or models that merge the conclusions derived from the control level (Poch et al., 2004). Two supervisor modules were proposed for adjusting the control level output for the primary disinfection: Supervisor level for effluent water quality ( $\text{SL}_1$ ) and supervisor level for the formation of other DBPs ( $\text{SL}_2$ ).

$\text{SL}_1$  aims at identifying any variability and uncertainty in the process that is not explained by the control level. This can be related to changes in the NOM composition that affect THMs formation potential described by other surrogate measures (Awad et al., 2018; Golea et al., 2017). Also, this algorithm evaluates the  $\text{THM}_{\text{ST}}$  and takes into account the effect that variations in  $\text{HRT}_{\text{ST}}$  has in THMs formation. Hence, the algorithm in  $\text{SL}_1$  acts as

a feedback control system, regulating the primary disinfection set-points according to the  $\text{THM}_{\text{ST}}$  measure.

$\text{SL}_2$  was designed for ensuring compliance with effluent water quality regulations regarding chlorate and chlorite. Since there are so many variables linked with chlorite and chlorate concentration at the DWTP effluent and guided by previous experience of the full-scale plant managers,  $\text{SL}_2$  objective is to limit the total amount of  $\text{NaOCl}_{\text{Dose}}$  and  $\text{ClO}_{2\text{Dose}}$  added to water at the primary disinfection step. This way, high concentrations of chlorites and chlorates in the effluent water are avoided.

A general structure of the EDSS for the present study is shown in Figure 29.

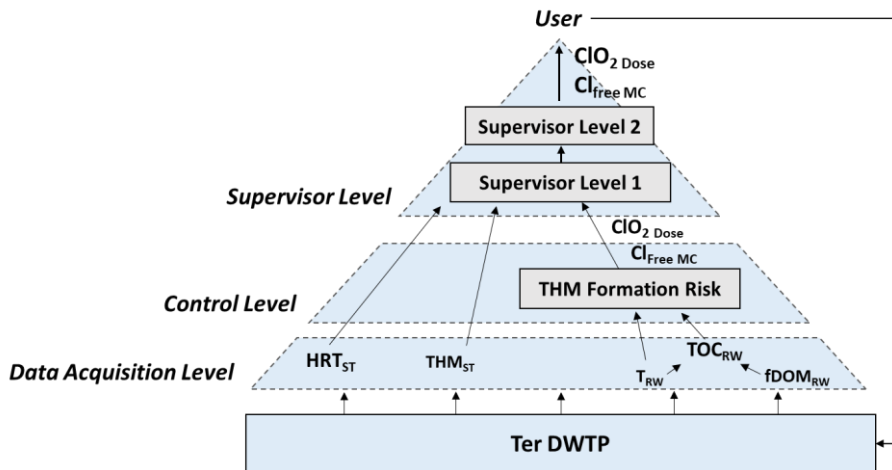

**Figure 29.** Hierarchical structure of EDSS employed in this study

### 6.3. Results and Discussion

In this section, the development and implementation of the advanced control system is discussed.

#### 6.3.1. Development of the control level of EDSS

A first FIS algorithm (FIS<sub>1</sub>) was developed for assigning ClO<sub>2</sub> Dose and Cl<sub>free MC</sub> set-points by assessing the THMs formation risk (THMFR) as a feed-forward control system. TOC<sub>RW</sub> and T<sub>RW</sub> were selected as the main quality parameter and environmental condition to assess the raw water THMFR. These two parameters were chosen according to the availability of online measures, and were supported by the DWTP process experts.

Following the hierarchical structure of EDSS, the control level contains FIS<sub>1</sub> algorithm and sets the order of magnitude of the expected primary disinfection operational set points (ClO<sub>2</sub> Dose and Cl<sub>free MC</sub>) in a feed-forward manner. The main objective of this algorithm is to prioritize ClO<sub>2</sub> over NaOCl dosing where THMFR is high and hence, reduce the formation of THMs in these situations. Expert opinion and historical data on the relationship between T<sub>RW</sub> and TOC<sub>RW</sub> values and THMFR in the treated water was used for the development of FIS<sub>1</sub>. Figure 30 shows the triangular fuzzy set membership functions defined for input and output variables.

According to FIS<sub>1</sub>, THMFR is positively correlated with TOC<sub>RW</sub> and T<sub>RW</sub>, which is in accordance with the a priori knowledge of the process and predictive models that can be found in the literature (Chowdhury et al., 2009; Golea et al., 2017; Kulkarni and Chellam, 2010).

Regarding the primary disinfection set-points assignment and according to the historical operation of the DWTP, it was assumed that a maximum THMFR corresponded to 1.2 mg·L<sup>-1</sup> and 0.65 mg·L<sup>-1</sup> for ClO<sub>2</sub> Dose and Cl<sub>free MC</sub>, respectively. On the other hand, a minimum THMFR should correspond to 0.3 mg·L<sup>-1</sup> and 1.5 mg·L<sup>-1</sup> of ClO<sub>2</sub> Dose and Cl<sub>free MC</sub>, respectively. Intermediate THMFR were interpolated from these two extremes and rules established for the fuzzy inference is shown in Table 9.

The cases selected for building up the membership functions and the inference system were aimed at providing good effluent quality, targeting a THMs concentration at the effluent of the DWTP in the range of 25-45 µg THM·L<sup>-1</sup> in order to ensure levels well below the regulation limits along the distribution network.

**Table 9.** Inference rules used in FIS<sub>1</sub>.

Rules	Inputs (If...)	Outputs (Then...)
1	TOC <sub>RW</sub> is Low and T <sub>RW</sub> is Low	Cl <sub>Free</sub> is Maximum and ClO <sub>2 Dose</sub> is Minimum
2	TOC <sub>RW</sub> is Low and T <sub>RW</sub> is Medium or TOC <sub>RW</sub> is Medium and T <sub>RW</sub> is Low	Cl <sub>Free</sub> is High and ClO <sub>2 Dose</sub> is Low
3	TOC <sub>RW</sub> is Low and T <sub>RW</sub> is High or TOC <sub>RW</sub> is Medium and T <sub>RW</sub> is Medium or TOC <sub>RW</sub> is High and T <sub>RW</sub> is Low	Cl <sub>Free</sub> is Medium and ClO <sub>2 Dose</sub> is Medium
4	TOC <sub>RW</sub> is Medium and T <sub>RW</sub> is High or TOC <sub>RW</sub> is High and T <sub>RW</sub> is Medium	Cl <sub>Free</sub> is Low and ClO <sub>2 Dose</sub> is High
5	TOC <sub>RW</sub> is High and T <sub>RW</sub> is High	Cl <sub>Free</sub> is Minimum and ClO <sub>2 Dose</sub> is Maximum



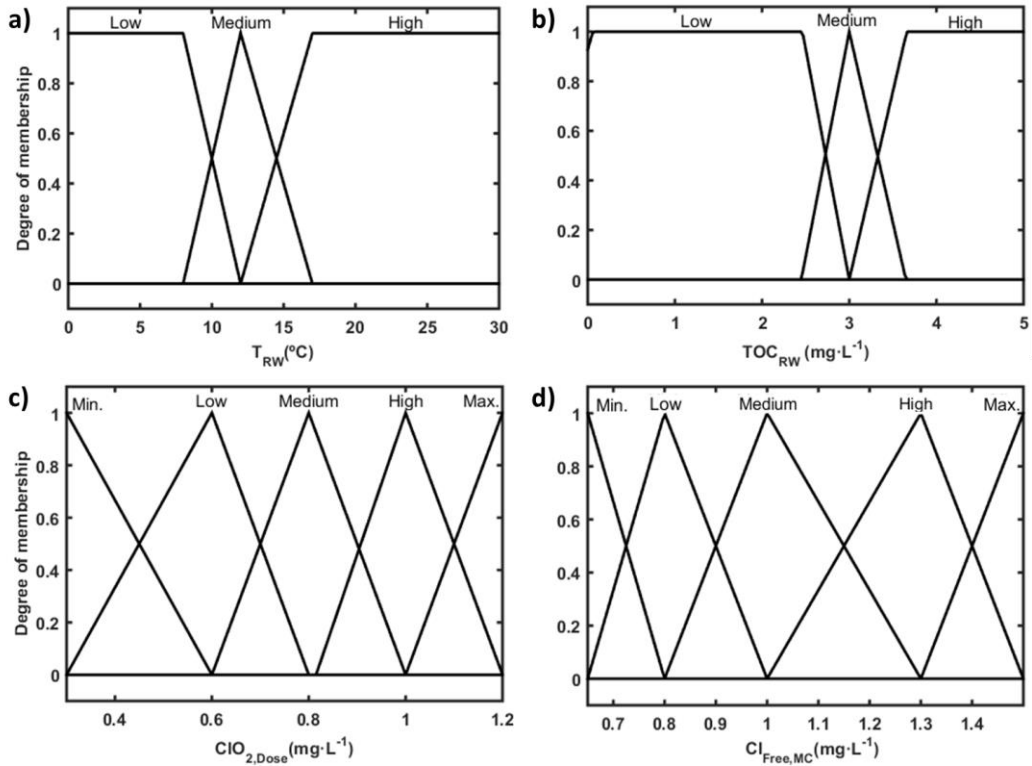

**Figure 30.** Membership functions for the inputs (a, b) and output variables (c, d) of FIS<sub>1</sub>.

### 6.3.2. Development of the supervisor level 1 of EDSS

The algorithm in SL<sub>1</sub>, named FIS<sub>2</sub> is also based on fuzzy-logics is described in this section.

Given a certain composition of NOM and environmental conditions, the THM<sub>ST</sub> measure will vary depending on the operational conditions of the DWTP (controlled by HRT<sub>ST</sub>). At the same time, given a certain environmental and operational conditions at the DWTP, THM<sub>ST</sub> will vary depending on the NOM quality and quantity. Since NOM quantity is already assessed in FIS<sub>1</sub>, changes in raw water quality (and not measurable with TOC<sub>RW</sub>) affecting THMs formation can be assessed in FIS<sub>2</sub> with THM<sub>ST</sub> and HRT<sub>ST</sub> as inputs. The supervisor factor (SF) is defined in FIS<sub>2</sub> to adjust the ratio between the free chlorine and chlorine dioxide dose. Hence, the outputs of this supervisor algorithm are the variation on the amount of free chlorine and chlorine dioxide dose with respect to the FIS<sub>1</sub>

outputs, named  $\Delta Cl_{Free}$  and  $\Delta ClO_2$ , respectively. Table 10 and Figure 31 show the inference rules and the membership functions designed for FIS<sub>2</sub>, respectively.

According to the purposed algorithm, the SF is increased as the THM<sub>ST</sub> increase and HRT<sub>ST</sub> decreases. Also, as THMs increase, the effect of HRT becomes less important and the SF effect becomes greater. This asymmetric inference was designed to have more intense responses of the SL<sub>1</sub> in front of THMs increments and to avoid THM<sub>ST</sub> peaks.

**Table 10.** Inference rules used in FIS<sub>2</sub>.

Rules	Inputs (if...)	Outputs (then...)
1	THM <sub>ST</sub> is Low and HRT <sub>ST</sub> is High	$\Delta Cl_{Free}$ is Minimum and $\Delta ClO_2$ is Minimum
2	THM <sub>ST</sub> is Low and HRT <sub>ST</sub> is Medium or THM <sub>ST</sub> is Medium and HRT <sub>ST</sub> is Medium	$\Delta Cl_{Free}$ is Low and $\Delta ClO_2$ is Low
3	THM <sub>ST</sub> is Low and HRT <sub>ST</sub> is Low or THM <sub>ST</sub> is Medium and HRT <sub>ST</sub> is Medium or THM <sub>ST</sub> is Low and HRT <sub>ST</sub> is Low	$\Delta Cl_{Free}$ is Medium and $\Delta ClO_2$ is Medium
4	THM <sub>ST</sub> is Medium and HRT <sub>ST</sub> is Low or THM <sub>ST</sub> is High and HRT <sub>ST</sub> is Medium or THM <sub>ST</sub> is High and HRT <sub>ST</sub> is High	$\Delta Cl_{Free}$ is High and $\Delta ClO_2$ is High
5	THM <sub>ST</sub> is High and HRT <sub>ST</sub> is Low	$\Delta Cl_{Free}$ is Very High and $\Delta ClO_2$ is Very High
6	THM <sub>ST</sub> is Very High	$\Delta Cl_{Free}$ is Maximum and $\Delta ClO_2$ is Maximum

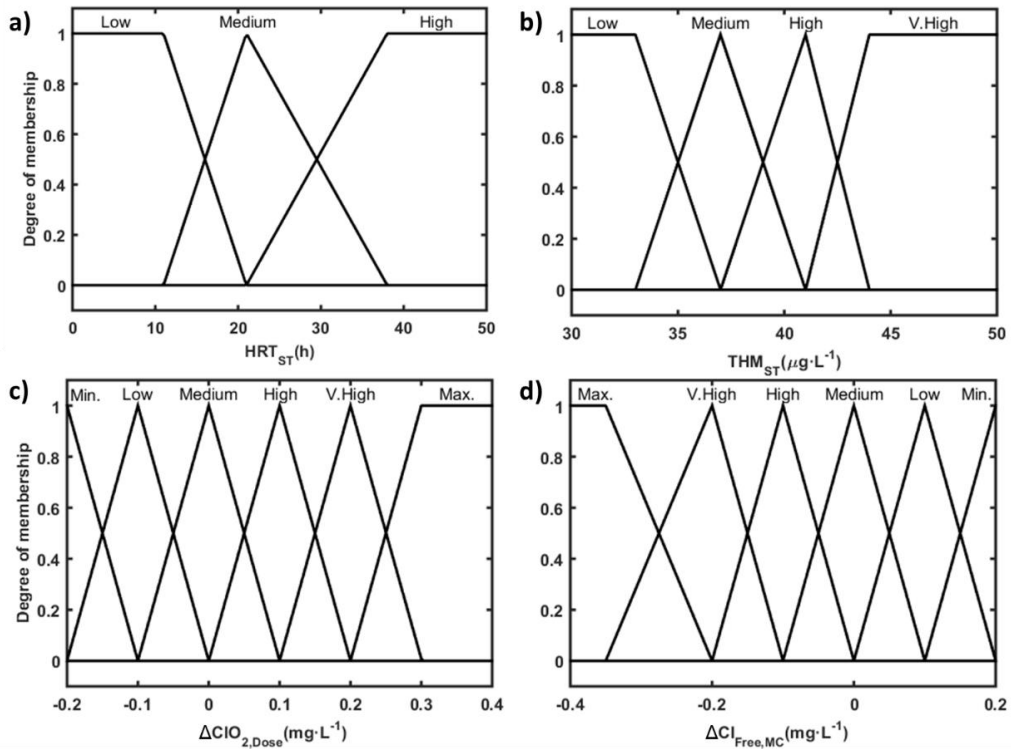

**Figure 31.** Membership functions for the input (a, b) and output variables (c, d) of FIS<sub>2</sub>

### 6.3.3. Development of the supervisor level 2 of EDSS

In order to predict the required NaOCl<sub>Dose</sub> for a specific Cl<sub>Free,MC</sub> and ClO<sub>2,Dose</sub> a linear regression was done with full-scale data from primary disinfection following the type:

$$Cl_{Free,MC} = a_1 \cdot ClO_{2,Dose} + a_2 \cdot NaOCl_{Dose} \quad (eq. 18)$$

Where  $a_1$  and  $a_2$  are 0.294 and 0.613, respectively, and are calculated from a linear regression ( $R^2= 0.71$ ). A plot of the fitted data and model outputs calculated from (18) is shown in the Annex IV (A4.1).

A decision tree for adjusting the proposed operational set-points to avoid high concentration of chlorites was developed and is shown in Figure 32.

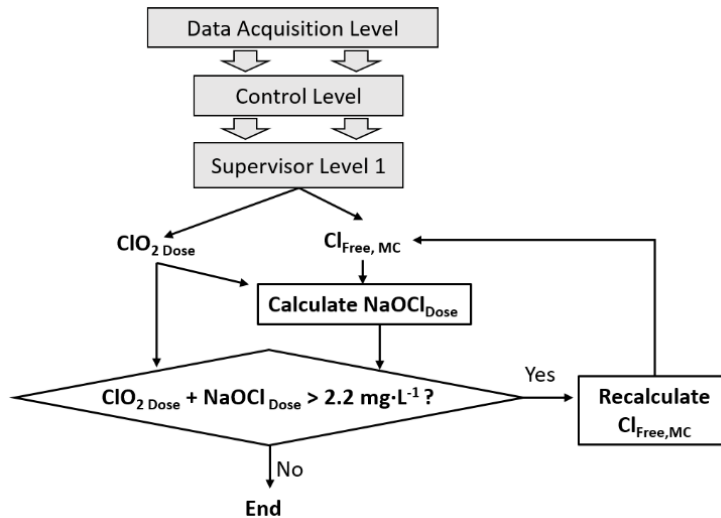

**Figure 32.** Workflow for supervisor level 2 of primary disinfection EDSS.

Once a  $\text{NaOCl}_{\text{Dose}}$  has been estimated for a certain  $\text{ClO}_2_{\text{Dose}}$  and  $\text{Cl}_{\text{Free,MC}}$  setpoints, the total combined dose must not surpass  $2.2 \text{ mg}\cdot\text{L}^{-1}$  at the primary disinfection. This limit was decided upon previous experience of plant managers. If this condition is not met,  $\text{Cl}_{\text{Free,MC}}$  setpoint is recalculated by lowering the  $\text{NaOCl}_{\text{Dose}}$  until the condition is fulfilled.

#### 6.3.4. Implementation and validation of the environmental decision support System

The developed EDSS was implemented at Ter DWTP. The EDSS acted as an open-loop control system with feed-forward and feed-back components for the 6-months study period (1/3/2019 – 1/9/2019). During this validation phase, it was up to the DWTP users whether to apply the proposed operational set-points or not and were asked to justify the cases in which EDSS outputs were not applied, forming a human-in-the-loop control system. This way, the system collects, transmits and analyses data to provide information to the DWTP users, who make the operational decisions to be implemented through the control system (Yuan et al., 2019).

The EDSS outputs during the time the EDSS was implemented were compared with a similar period without the fuzzy control system. Figure 33 shows the operational set-

points for the primary disinfection in similar periods with and without the developed fuzzy control system. The EDSS outputs and DBPs concentration during the time the EDSS was implemented at the full-scale plant are shown in and Figure 34, respectively.

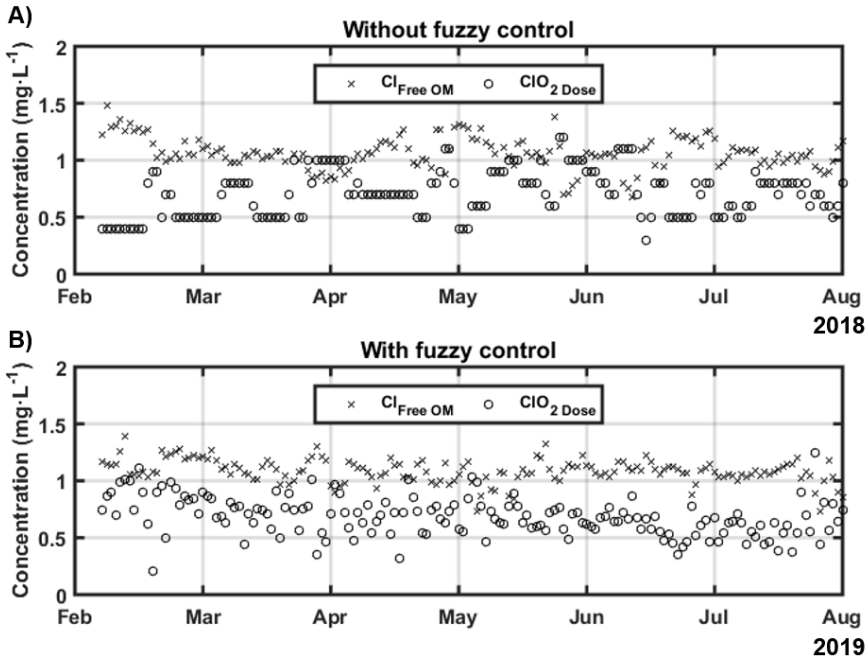

**Figure 33.** Time series of primary disinfection operational set-points. A) During a period without the fuzzy system and B) During a period applying the fuzzy control system.

By comparing the system’s operation in the two periods (with and without the control system) it can be observed some differences regarding the frequency in varying the operational set-points. For example, in Figure 33.A, it can be seen that chlorine dioxide dose was adjusted more frequently than the period without using the control system. This might be because quality and operational conditions vary in a daily basis, and this could be assessed systematically by means of the fuzzy control system. The model outputs were positively validated 194 out of 227 times (85.5%) during the studied period, meaning that EDSS recommendations were implemented for full-scale operation. Also, even it was not the goal of the proposed control system, a reduction of about 4.2% and 0.7% in the chlorine dioxide and sodium hypochlorite dosing, respectively, was observed comparing the results with the period without using it. These percentages were calculated using the daily averages of chemical dosing rates.

Figure 34 shows the DBPs concentrations monitored at Ter DWTP during the implementation phase of the EDSS, also compared with a similar period without the developed control system.

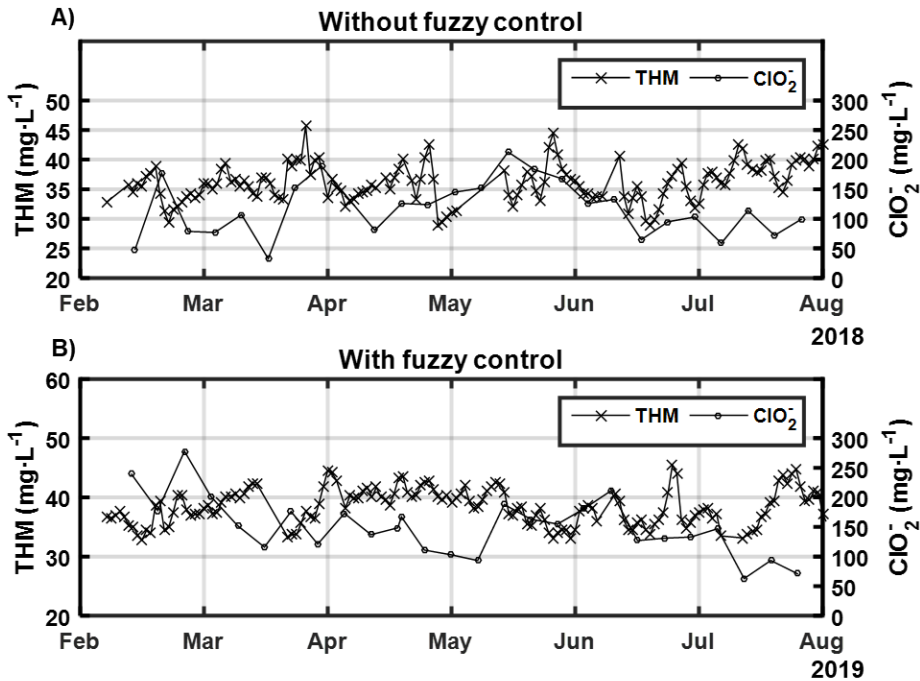

**Figure 34.** Time series of DBPs concentrations at Ter DWTP effluent: A) During a period without the fuzzy control system and B) During a period applying the fuzzy control system.

In terms of THMs and chlorites formation, no significant differences were found between the two periods. The overall performance of the control system during the studied period was satisfactory in terms of THMST and chlorites, staying in a tolerable range (30 - 45  $\mu\text{g}\cdot\text{L}^{-1}$  and 60-210  $\mu\text{g}\cdot\text{L}^{-1}$ , respectively) to supply along the water supply system.

Variations in raw water quality lead to adjustments of the operational set-points by both the control and supervisor level of the primary disinfection EDSS. Evolution of input parameters over time during the studied period, as well as detailed responses of the control level,  $SL_1$  and  $SL_2$  can be found in the Annex IV (sections A4.2 and A4.3, respectively). It is shown that  $\text{TOC}_{\text{RW}}$  values ranged from 1.6 to 3.0  $\text{mg}\cdot\text{L}^{-1}$  and  $T_{\text{RW}}$  between 10 and 16°C, and this is reflected in the slightly modified responses of the

control level. The control level responses were in the 1.0 to 1.3 mg·L<sup>-1</sup> range for Cl<sub>free MC</sub>, and in the 0.5-1.0 mg·L<sup>-1</sup> range for ClO<sub>2 Dose</sub> set-points. During this period, it was shown that even there was feed-forward responses of the control level regarding THMFR, there was the need to further adjust the operational set-points according to the THM<sub>ST</sub> variations. Therefore, a supervisor level to adjust these unexpected changes as a feedback control strategy was necessary. These unexpected variations on the DBPs formation can be linked to possible variations of NOM fractioning or quality of water not measurable with surrogate measures like TOC<sub>RW</sub> (Golea et al., 2017).

The supervisor level showed short-time variations on the responses compared to the control level, and these were due to changes in operation of the supply network and also changes in THM<sub>ST</sub> concentration. The intensity of the supervisor level was the highest with high THM<sub>ST</sub>, leading to lower the Cl<sub>free MC</sub> and to increase the ClO<sub>2 Dose</sub>. These cases were seen the greatest around day 30, 60, 105 and 130.

Model outputs were not applied in 33 out of 227 cases. Reasons accounting for the cases were: too high Cl<sub>free MC</sub> (33.3%), too high ClO<sub>2 Dose</sub> (48.5%), too low ClO<sub>2 Dose</sub> (15.2%) and others (3.0%). The inputs and outputs of the EDSS, as well as justifications provided by the users were recorded for follow-up and validation purposes. This provided a useful database that can be used for assessing EDSS performance and if necessary, to support modifications on the model parameters.

### 6.3.5. Implications for drinking water treatment

Expert knowledge has been used to control DBPs formation at the primary disinfection step by integrating the outputs of different algorithms in the hierarchical structure of the EDSS (data acquisition, control and supervisor level). The presented study demonstrates that with few on-line available measures such as TOC<sub>RW</sub>, T<sub>RW</sub> and THM<sub>ST</sub>, a disinfection process can be controlled to avoid high concentration of DBPs consistently. Fuzzy-logic systems combine available data, scientific theory and expert opinion, and this allowed handling complex non-linear phenomena such as DBPs formation in DWTP using commercially available online sensors. In the present study, a data-driven approach was not convenient due to the few availability of data and the high correlation of water quality and operational parameters that occur in drinking water processes (Baxter et al., 1999), leading to models that may render good replicative accuracy but which results might not be physically plausible. As outlined in Krueger et al. (2012), qualitative reasoning in systems like FISs can be powerful tools to provide a basis of action on complex systems before inconclusive evidence becomes available.

To support the knowledge-based AI technique choice, it was considered important that the system was able to report the outputs of the models to the DWTP managers and operators in a user understandable manner, so model parameters can be accordingly tuned. Also, this flexible approach allows the users to add new rules if deemed necessary. For example, as more data and knowledge about the occurrence of still non-regulated DBPs is provided (such as haloacetic acids or N-nitrosodimethylamine), new criteria can be incorporated for DBPs management at DWTPs.

FISs were deemed as excellent candidates for modelling the consolidating the accumulated experience of full-scale operation of a DWTP. From the academic side, the collaborative work makes sure that the scope of EDSS fits users' needs and interest. On the other hand, practitioners taking part in the modelling process are informed about the modelling assumptions and limitations. This latter part underpinned the application of the developed EDSS at the full-scale plant. Once implemented, it was shown that the system provided DWTP operators with augmented capacity for decision-making at DWTP, which was considered important since usually operators are working in shift-schedule and decisions have to be taken out of the office hours.

#### 6.4. Conclusions

Fuzzy inference systems (FISs) were used to control the combined oxidants dose in the primary disinfection step of a DWTP. The developed models were integrated into an environmental decision support system for aiding in the daily decision-making of the plant. The control level of the EDSS consisted in a feed-forward control system that assesses the THMs formation risk, and the supervisor level adjusted the operational set-points regarding the actual THMs concentration at the effluent in a feed-back manner. The proposed system allowed to control disinfection by-products (DBPs) formation using commercially-available sensors and process knowledge of the full-scale plant. Phenomena not fully understood such as composition of the natural organic matter could be dealt with this system and the primary disinfection process of a DWTP. The performance of the developed fuzzy control system was compared using a similar control period, and it was observed that the EDSS allowed a more systematic adjustment on the operational set-points by assessing the quality and operational conditions in a daily-basis. The recommendations of the EDSS were applied at the case study DWTP about 85.5 % of the time during a 6-month period, with THMs concentrations being in a



tolerable range (between 30 and 45  $\mu\text{g}\cdot\text{L}^{-1}$ ). Therefore, the results were satisfactory in terms of DBPs formation according to the utility needs. The user-understandable reasoning of FISs improved user engagement on the use of advanced control systems for the management of complex drinking water processes. Above all, the presented methodology can be of interest to DWTP practitioners who wish to systematise the decision-making and to develop control strategies for managing DBPs formation.

## 7.Results IV

Development of a key performance indicator based on quantitative microbial risk assessment for a drinking water treatment plant

Redrafted from:

**Godo-Pla, L.,** Valero, F., Rodríguez, J. J., Emiliano, P., Poch, M., Monclús, H., 2020. Development of a key performance indicator based on quantitative microbial risk assessment for a drinking water treatment plant. (In preparation).



## 7.1. Background

Regarding the microbiological safety of drinking water, several guidelines have been established for ensuring an adequate removal of pathogens along the treatment process and meet health-based targets at both national and international level (Medema et al., 2006; USEPA, 2003, 1998; World Health Organization, 2016).

Quantitative microbiological risk analysis (QMRA) is a probabilistic approach typically performed at a design stage of DWTPs to check whether a water system is able to cope with the expected pathogen load in the source water. Its assessment consists basically four steps: 1) Hazard identification; 2) Exposure assessment, 3) Dose-response and 4) Risk characterisation. The annual probability of infection and the disability-adjusted life years (DALY) are commonly used metrics that are useful for quantifying and comparing the burden of disease associated with water-related pathogens. In this regard, the World Health Organization has defined a tolerable burden of disease of  $10^{-6}$  DALY per person per year for individual components in drinking water (World Health Organization, 2017).

Among other possible microbial indicators like *Giardia*, *Escherichia Coli* or rotavirus, *Cryptosporidium* has been reported as a conservative protozoan species for QMRA analysis of surface water DWTPs, because of its higher infectivity and resistance to chemical disinfection (Pecson et al., 2017; Teunis et al., 1997; World Health Organization, 2009). These microbial indicators are often difficult to detect along the drinking water treatment process, and this pose a challenge to assess the exposure of a certain pathogen. Because of this, surrogate parameters are frequently used for assessing the microbiological quality of water at DWTPs. Due to the difficulty of having site-specific data, most QMRA relies on reported values of removal efficiencies for conventional treatments like coagulation/flocculation and rapid filtration, but these efficiencies depend on the process performance and can suffer short-time variations (Medema et al., 2006; Teunis et al., 2009). Despite the inherent variabilities and uncertainties of QMRA calculations, this method remains recognised as the best approach to water safety (Bichai and Smeets, 2013).

In the framework of global change and increasing water scarcity, non-conventional water sources such as recycled wastewater (through direct or indirect reuse schemes) can play a key role in integrating water supply strategies (Purnell et al., 2020), but this can lead to increase the pathogen load in existing DWTPs which were initially designed

for this. Moreover, due to growth of population, utilities are expected to increase flowrate to fulfil supply network requirements at the expenses of a possible worsening of the treatment performance. The occurrence of relatively extreme events in source water and treatment perturbations can lead to intolerable scenarios being unrecognised as such (Owens et al., 2020; Teunis et al., 2009, 1997). All these factors put a question mark on whether existing utilities are able to handle possible future scenarios and under which circumstances. As a result, the need for early-warning systems and strategies to detect and respond to acute events in drinking water systems is highlighted.

Digitalisation of industry is shifting DWTPs towards a more predictive and informed operation by using real-time data provided by sensors like quality, flows and other operational parameters (Sarni et al., 2019). In this sense, detrimental events in the water treatment process can be prevented by informatics systems. Different studies support that turbidity, rainfall and flowrate have positive relationship with indicator microorganisms (Tryland and Eregno, 2015), but a direct quantification with them might be very site-specific and difficult. Some attempts using data-driven models like Bayesian Belief have been applied successfully for surface water quality (Panidhappu and Li, 2020), but the availability of consistent data is sometimes difficult. Moreover, the development of process-based indicators for assessing the microbial removal efficiency is challenging.

Key performance indicators (KPIs) are automatic, real-time indicators of a system commonly used in the smart industry that consolidate information coming from different devices. KPIs can be represented in end-user applications as traffic lights (informing for good, acceptable and bad status) for informing about the status of a system to a user in an intuitive way. The objective of this study is to develop a KPI related to the microbiological safety in a DWTP and integrate it as a tool to aid in daily decision-making. By means of commercially-available sensors, we propose to set the expected pathogen load and to monitor the performance of DWTP based on knowledge-based process performance indicators. The steps followed for the development of the QMRA-based KPI are presented for a case study DWTP in Barcelona area (NE Spain), and different treatment scenarios are discussed, using *Cryptosporidium* as the most conservative microbial indicator present in raw water.

ARTICLE IN PREPARATION. EMBARGO UNTIL PUBLICATION DATE

## 8. General discussion



This chapter discusses the practical implications of the developed EDSS modules for DWTP management and discusses the accomplishment of the general objective of this work. Finally, some general limitations and future steps are commented.

## 8.1. EDSSs for drinking water treatment

Drinking water treatment plants are exposed to increasing water quality restrictions while the quality of resources follows a negative trend. This is indeed a challenge for DWTP managers to make the best use of existing treatment units and adapt them to a varying raw water quality. Whereas research on disinfection by-products and natural organic matter transformation along drinking water treatment process has gained much research attention, many EDSS authors have outlined the need for translating all this knowledge into models that can more accurately reflect DWTP needs. In this sense, this thesis tackles some of the main issues in DWTP process control such as the management of oxidation and disinfection processes taking into account the by-products formation, and makes a step-forward in practical applications of EDSS at full-scale plants.

The water sector is undergoing a digital transformation to face challenges related to sustainability of resources, infrastructure management, climate change and demographics (Sarni et al., 2019). Among operational aspects of DWTPs, real-time support by means of predictive models is thought to have an important effect in operation in what is known as augmented intelligence (Savic, 2020). In these systems, AI methods enhance human decisions, which are at the centre of the control loop.

The EDSS development framework proposed in Poch et al. (2004) has been followed to address some of the main operational challenges of surface water treatment plants using two full-scale DWTPs as case studies. Following exhaustive technical and scientific revision, different models have been developed to predict the operational set-points and provide recommendations to treatment plant managers. Special attention has been paid in developing models that make the best use of available data (from sensors, probes and lab data) and the experience of plant managers to handle operational set-points. This premise led to develop knowledge-based and data-driven models with the objective of delivering support to decision-making in the more transparent and user-understandable manner.



## 8.2. Models Integration and Decision Support

The developed models have been integrated in one EDSS for each case study DWTP: Llobregat and Ter. The graphical user interfaces developed for these two EDSSs, as well as for the microbiological risk supervisor system, are presented in the following subsections.

Generally, the presented tools share the same objective of retrieving data from the online data acquisition system, but allowing the user to edit input values for performing analysis of treatment scenarios. Detailed information about each component of the EDSS is displayed and a user guide for each application was provided to the users.

### 8.2.1. DrinkIA PTLL EDSS

The different EDSS modules developed for Llobregat DWTP were integrated under a common platform, called DrinkIA-PTLL, whose main screen can be seen in Figure 42.

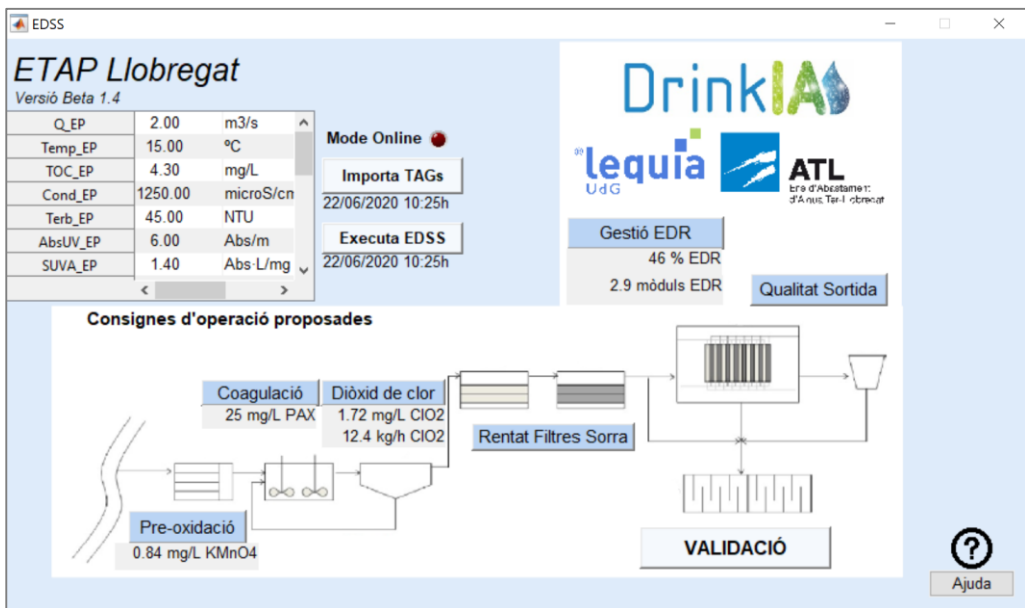

Figure 42. Screenshot of the DrinkIA-PTLL EDSS: Main screen

On the upper-left corner there is a table with all the input variables used by the different modules integrating the EDSS. The values of the variables are automatically read either from the SCADA System (instantaneous reading) or from the historical data database, depending on their availability. In the case that some sensor is out of service or gives abnormal values, data is retrieved from the laboratory analysis database of ATL. The user can see the value, the units and also the time that they were retrieved and refresh their values by clicking on a button. Also, the user can edit these values to check the EDSS performance for different quality scenarios.

The treatment train of Llobregat DWTP along with the main operational set-points proposed by the EDSS is shown at the centre of the screen. The proposed set-points are:

- a) Dosing rate of potassium permanganate at the pre-oxidation step.
- b) Dosing rate of polyaluminum coagulant at the coagulation step.
- c) Dosing rate of chlorine dioxide at the oxidation step.
- d) Number of EDR modules to activate at the EDR step.

Overall, the tool presents high flexibility for performing scenario analysis and the user has access to separate screens for more detailed information about the different models in a user-understandable manner. The components b) and c) were developed but are outside of the scope of this thesis. Components a) and d) are further explained in the following two subsections.

#### 8.2.1.1. Pre-oxidation module

Figure 43 shows the pre-oxidation module, that integrates the models developed in Chapter 4.

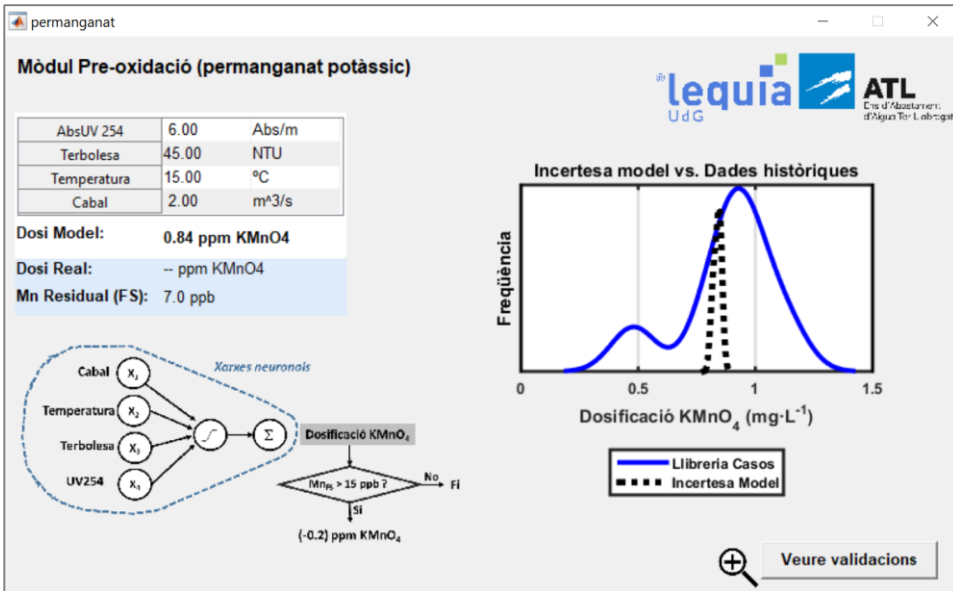

**Figure 43.** Screenshot of the DrinkIA-PTLL EDSS: Pre-oxidation module

The input variables together with their values are displayed in the upper-left corner, together with the proposed dosing rate by the predictive model. A representation of the artificial neural network structure and the expert rules that supervise it are shown below. In this case, it is shown that the output of the ANN is coupled with an expert rule that supervises the concentration of residual manganese at the effluent of the sand filters.

Uncertainty of the model, together with a case-based representation of past actions of users given similar quality conditions, is displayed on the right side of Figure 43. This representation is aimed at supporting the predictive model output and allows the user to gain confidence on the mathematical models.

Finally, the user can also look at manually validated scenarios that are similar to the present one by clicking the button at the bottom-right corner.

## 8.2.1.2. EDR Management

The predictive model for THMs formation at Llobregat DWTP was incorporated in the DrinkIA-PTLL EDSS as shown in Figure 44.

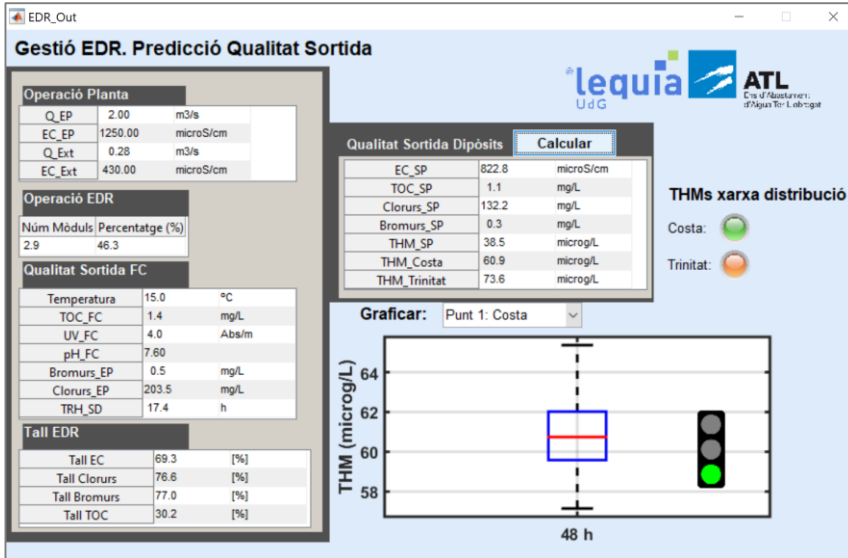

**Figure 44.** Screenshot of the DrinkIA-PTLL EDSS: EDR Management

Different tables on the left side in Figure 44 show the operational and quality parameters of Llobregat DWTP that influence DBPs formation and therefore, the EDR management. These values are automatically imported from online sensors, and some of them are calculated from other measures. All of them are editable, allowing the user to perform treatment scenarios. Given the quality parameters of GAC effluent and the operational parameters of EDR (number of modules), the EDR effluent quality is calculated. Then, the THMs formation model developed in Chapter 5 is fed with this data, and results are displayed in the graphic on the bottom-right corner of the figure.

Several results can be displayed, in particular:

- THMs formation curve (from 0 to 120h).
- THMs prediction at DWTP storage tanks effluent (boxplot with Monte Carlo outputs).
- THMs prediction at critical point of the distribution network equivalent to a hydraulic retention time of 48h (boxplot with Monte Carlo outputs).
- THMs prediction at critical point of the distribution network equivalent to a hydraulic retention time of 96h (boxplot with Monte Carlo outputs).

With this information, the user can check the effects of operating the EDR treatment with different number of modules and see the predicted THMs formation along different points of the distribution network. The traffic light is a visual indicator of the predicted water quality according to the standards of the distribution network management practices.

### 8.2.1.3. Validation

Validation of the different DrinkIA PTL EDSS components is performed by accessing the validation tab (Figure 45).

The screenshot shows a web application window titled 'Validació EDSS'. It features the logos for 'lequia U+G' and 'ATL Institut d'Anàlisi i Innovació'. The main content includes a table with the following data:

	Resultat EDSS	Correcció	
Dosi KMnO4 (mg/L)	0.84	0.84	<input checked="" type="checkbox"/> Validar
Dosi PAX (mg/L)	25.00	25.00	<input checked="" type="checkbox"/> Validar
Dosi ClO2 (mg/L)	1.70	1.25	<input type="checkbox"/> Validar
Mòduls EDR	2.95	3.20	<input type="checkbox"/> Validar

Below the table is a 'Comentaris' section with five text input fields labeled: 'Model Permanganat', 'Model Coagulació', 'Model Diòxid Clor', 'Filtres de Sorra', and 'Model EDR'. At the bottom left is a dropdown menu '<Escollir usuari>' and a large 'REGISTRAR' button.

**Figure 45.** Screenshot of the DrinkIA-PTLL EDSS: Validation tab.

In this tab, users can validate the results proposed by the EDSS on the different modules by clicking a check-box or by manually correcting the proposed solution. To further justify the correction or to provide feedback to the EDSS developer, there are text boxes where the user can insert comments for each EDSS module.

Finally, the user is identified and the validation information is registered into a Microsoft Excel® file for the purpose of following up the EDSS implementation and validation.

### 8.2.2. DrinkIA PTT EDSS

Results obtained in Chapter 6 using Ter DWTP as case study have been integrated in the DrinkIA PTT EDSS, aimed at supporting decision-making at the treatment units.

Following in the same way as for the DrinkIA-PTLL EDSS, the main screen of DrinkIA-PTT is shown in Figure 46, where the data acquisition, operational set-points proposed by the system and tabs linking to the different modules can be accessed.

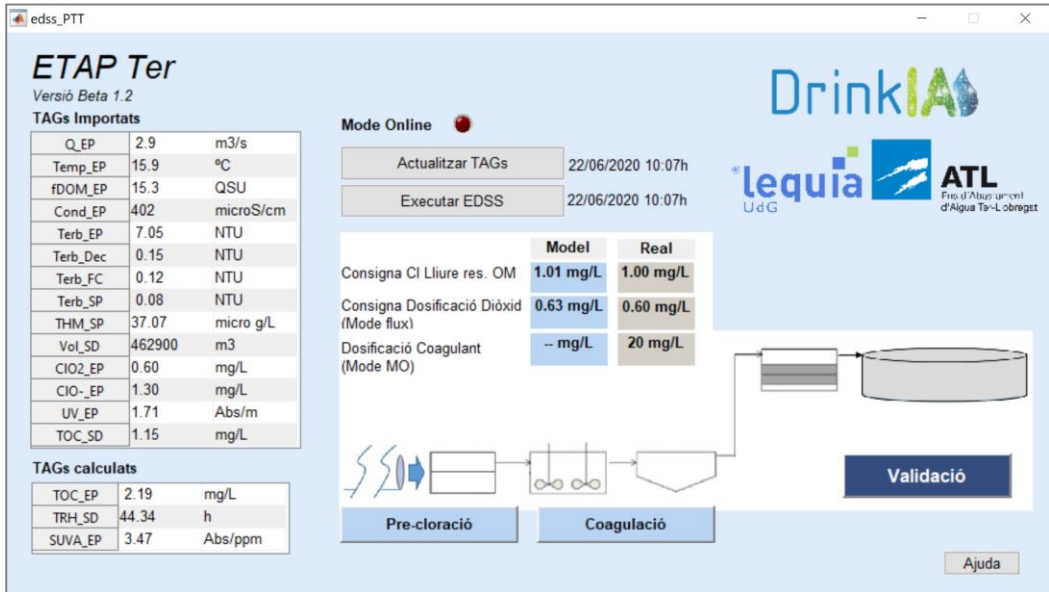

**Figure 46.** Screenshot of the DrinkIA-PTT EDSS: Main screen

The proposed set-points for Ter DWTP are:

- Dosing rate of chlorine dioxide at the primary disinfection step.
- Free-chlorine set-point at the primary disinfection step.
- Dosing rate of coagulant at the coagulation step.

The proposed set-points by the EDSS can be validated and feedback from users can be registered at the validation tab. The component c) is outside of the scope of the thesis and is not included in this discussion. Components a) and b) are described in the following subsection.

8.2.2.1. Primary Disinfection

The primary disinfection tab is shown below in Figure 47.

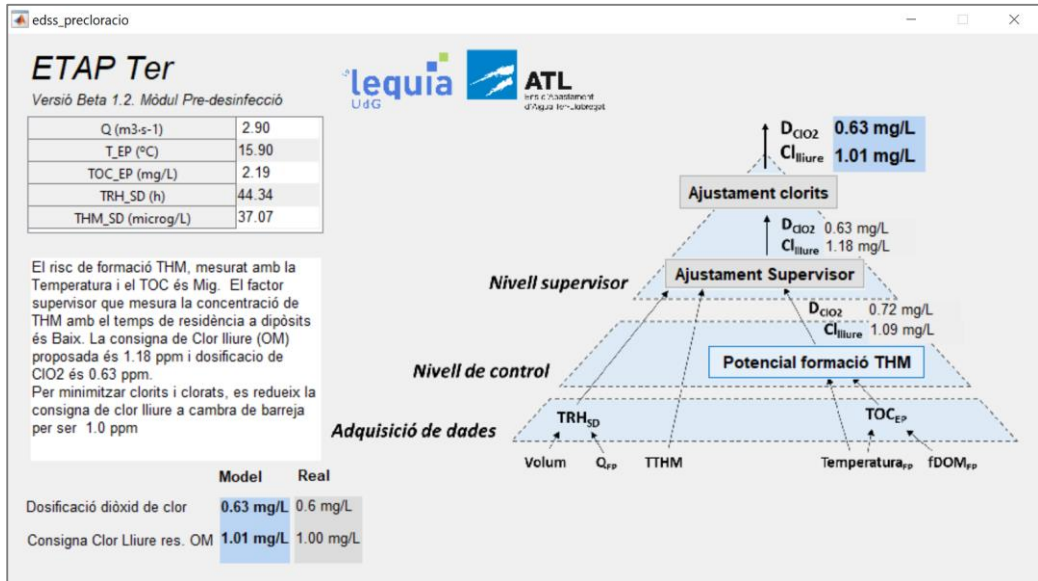

Figure 47. Screenshot of the DrinkIA-PTT EDSS: Primary Disinfection.

In this screen, users can consult the values of the input variables that are taken into account for the control of the primary disinfection step. On the right side of Figure 47, the different levels of the EDSS architecture is shown and divided into Data Acquisition, Control level and Supervisor level. The reasoning algorithms composing these levels are discussed in Chapter 6 and users can know the detail of the fuzzy systems by clicking on the different tabs.

A text describing the reasoning model and is displayed at the left side of the screen. This text justifies the proposed operational set-points in qualitative terms for the primary disinfection, which are shown at the bottom-left part of the screen. This way, the users can see the steps followed by the EDSS to reach a solution.

### 8.2.3. Microbiological risk-based supervisor system

The framework for assessing the risk associated with waterborne pathogens in drinking water discussed in Chapter 7 has been integrated into an application for real-time supervision of the drinking water treatment, using Ter DWTP as case study (Figure 48).

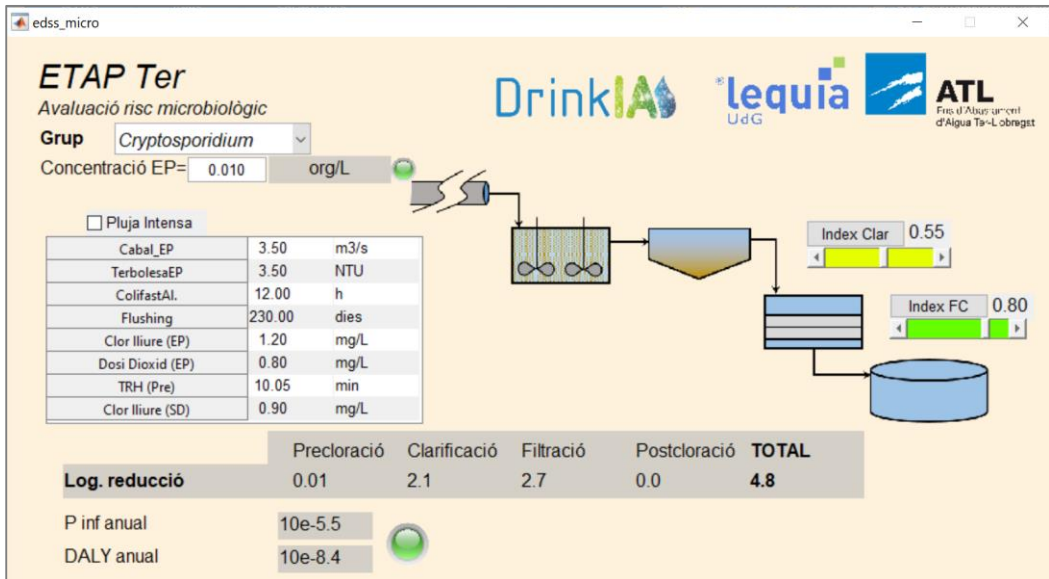

**Figure 48.** Screenshot of microbiological risk-based supervisor system.

In this application, the users can visually check the status of the treatment process in terms of risk related to the presence of microorganisms at the DWTP influent.

The target microorganism is selected from a drop-down list displayed at the upper-left corner of the screen. The expected influent load, according to raw water characteristics in the left side of the picture is also shown.

Then, the removal performance of the main treatment units (primary disinfection, coagulation/flocculation and rapid filtration) for the selected microorganism is shown. Finally, two metrics assessing the risk associated with drinking water at the DWTP effluent are shown: Annual probability of infection ( $P_{\text{inf annual}}$ ) and disability adjusted life years per person per year (DALY ppy).

A traffic light is displayed at the bottom of the screen, indicating the risk associated with the actual operation of the plant.



### 8.3. Main contributions regarding the control and management of DWTPs

Chapter 4 reports on the development of an artificial neural network that predicts the potassium permanganate dose to be applied to the raw water of a drinking water treatment plant, in order to maximise the oxidative capacity at this point. Data-driven models like ANNs can be built upon real data generated in full-scale DWTP to predict operational parameters that best cope with inflow water quality. In order to overcome the black-box nature of data-driven models, a comprehensive parameter estimation, uncertainty and sensitivity analysis of the models has been reported. Moreover, a case-based reasoning model has been developed to further support the predictive model outputs. The uncertainty propagation in the ANN and the results of CBR system allows the end-user to gain confidence upon model results. The developed model considers the influent water quality, as well as operational conditions, for predicting the potassium permanganate to be dosed. Therefore, the study tackles some of the main issues in DWTP process control and quantification of uncertainty of ANNs. The presented configuration has proved a great potential for incorporating black-box models in decision-making processes. Finally, a graphical user interface has been presented for interfacing the model outputs with the end user.

Chapter 5 tackles the formation of disinfection by-products and links it to the operation of the advanced treatment process of Llobregat DWTP, which consists of an electro dialysis reversal step. THMs formation has been largely studied in the drinking water treatment field and several empirical models have been developed, but so far, no studies have reported their implementation at the operation level of drinking water systems. Predictive models for THMs formation have been compared using field-scale data and the uncertainty of model outputs has been quantified for a Llobregat DWTP. In the light of the results obtained, the presented tool has proved to be very useful and capable of predicting DBPs formation under all the conditions included in the studied one-year period (1/3/2019 – 1/3/2020).

Chapter 6 reports on the development of a novel control strategy for the primary disinfection process in a surface drinking water treatment plant. Knowledge-based models like fuzzy inference systems were built upon the experience of plant managers in full-scale DWTP to handle operational set-points, using data from commercially available sensors. The present study focuses in a case-study DWTP whose primary disinfection consisted in a combined dosing of chlorine dioxide and sodium hypochlorite. The phenomena occurring in drinking water treatment and factors associated with disinfection by-product formation have been carefully taken into consideration. The

developed models have been integrated into an environmental decision support system (EDSS) that provides treatment recommendations to DWTP users in real-time, considering influent and effluent water quality. In the light of the results obtained, the presented tool has been very useful and capable of managing DBPs formation under all the conditions included in a 6-months testing period at full-scale. The presented methodology can be used at similar surface water DWTPs for developing control strategies to manage DBPs formation in such nonlinear systems where few data available but there is a valuable accumulated experience in managing the process.

The two main challenges of drinking water production are minimising DBPs formation, while minimising microbial risk associated with raw water. Chapters 4 to 6 have focused in providing treatment recommendations that either directly (through model predictions) or indirectly (through systematisation of the know-how) target a minimisation of DBPs formation. Chapter 7 proposes a framework for developing a new key process indicator (KPI) based on quantitative microbial risk analysis that evaluates the risk of the actual operation conditions of a DWTP under expected pathogen loads. The KPI is intended to be integrated in SCADA systems as an alarm preventing from possible operation conditions leading to an increase of the microbial risk in water. In this way, it is ensured that individual EDSS modules aimed at minimising DBPs do not affect negatively the overall safety of drinking water.

In general, the work presented in this thesis provides example to other DWTPs willing to move toward the digitalisation of their operation practices. Some of the benefits that can be accomplished with the implementation of EDSS for aiding in the management of DWTPs are:

- Augmented capacities for DWTP users by means of process modelling and predictive tools.
- Deeper understanding on the process characteristics by performing treatment scenarios.
- Increased awareness and quantification about consequences of certain actions on the DBPs formation and/or microbiological risk.
- Real-time decision-support to face changes in raw water quality, increasing robustness of DWTPs' management.
- Increased autonomy of operators who are on shift works, especially when working out of office hours.

## 8.4. Present limitations and future steps

Although the main objective of this thesis was fulfilled, some aspects remain to be addressed in future research to further improve the developed tools in this thesis.

### ***Diversity of DWTPs related challenges***

First of all, there are a great diversity of DWTPs, depending on the source water quality they have to treat and each one of them have different operational challenges. In this thesis, operational challenges regarding the pre-oxidation, disinfection and electro dialysis process were addressed. Still, there are other aspects that need attention such as the management of the coagulation/flocculation and filtration processes. These latter ones, have also been also studied and models have been developed in the EDSS for Llobregat and Ter DWTPs, but they are still at a preliminary stage. More work is needed to formalise and validate these models.

Also, there is a great diversity of DWTPs and each one of them has different source water characteristics. At the present study, two DWTPs were analysed: Llobregat and Ter DWTPs. Even they are geographically close to each other (about 50 km), their source water presents huge differences, which generates different treatment and management needs. These two case studies can serve as an example of the heterogeneity of DWTPs and of different challenges to be faced. Nonetheless, specific studies would be necessary to translate the proposed systems to new DWTPs in order to tailor the EDSSs to the specific needs of these utilities.

### ***Model development challenges***

As regards model development, the quality of data-driven models is strictly dependent on the quality of data used for calibrating them. Datasets were carefully selected to use process representative data and for the operative range of each treatment unit. Even though, there are some limitations using field-scale data. On the one hand, field-scale data is representative of the full-scale process but on the other, the range of the input variables is limited to the natural variations of raw water. This is in contrast with lab-scale or experiments with synthetic waters, where the effect of each of the parameters can be individually assessed (through various experimental design approaches). Therefore, even special attention was taken on structural validation of the developed models, their use is limited to the case-study DWTP under the studied conditions. Further validation with lab-scale experiments could demonstrate a wider applicability or delimit the useful range of application of the mathematical models.

Also related to the availability of data that is used for modelling a system, some models were developed with the aim to optimise a system (e.g. by modelling the effect of a treatment unit on water quality variables) and others were focused on systematising a decision-making process (e.g. by finding patterns in the historical data relating raw water quality parameters and operational set-points). This has some limitations, as it relies on the good previous management of the plant. We consider that this is a first step in the digitalisation of these utilities, but modelling efforts should be directed to optimisation rather than just predictions from previous experiences. Anyhow, this is a first step towards a more systematic and resilient management of DWTP treatment units.

### ***Disinfection by-products related challenges***

Regarding DBPs formation, this work has focused almost exclusively in THMs, as this family of DBPs has been typically used as indicator compounds for other DBPs that cause toxic responses in drinking water. Nonetheless, THMs values are calculated as the sum of four different compounds (chloroform, bromodichloromethane, dibromochloromethane and bromoform), each one of them showing different toxicity. The proportion of these species on the overall THMs concentration has not been taken into account in the present study, which has focused more on the regulation limits rather than on the toxicological effects of these compounds. Quantitative chemical risk assessment could be performed in order to further evaluate the effects of the treatment (eg. EDR operation) not only on the quantity but also the composition of THMs.

Another challenge regarding model development is the inclusion of new DBPs that might be regulated in the near future. The present study has focused mostly on the formation of THMs, which have been the most targeted family of compounds in Spain since their inclusion in the European Directive (98/83/CE, 1998). Nonetheless, a new draft of the revised European drinking water directive was released at 2018 and new families of DBPs have been added to the watchlist, such as chlorites, chlorates and haloacetic acids. The concentration limits in the actual European Directive and in the renewed one are summarised in Table 14.

**Table 14.** Comparison of regulation limits for several disinfection by-products between the European Council Directive 98/83/EC and its proposed adaptation made in 2018.

Parameter	98/83/EC	98/83/EC – 2018 Adapted
Total trihalomethanes (THMs)	100 $\mu\text{g}\cdot\text{L}^{-1}$	100 $\mu\text{g}\cdot\text{L}^{-1}$
Haloacetic acids (HAAs)	-	80 $\mu\text{g}\cdot\text{L}^{-1}$
Chlorites	-	250 $\mu\text{g}\cdot\text{L}^{-1}$ (*)
Chlorates	-	250 $\mu\text{g}\cdot\text{L}^{-1}$ (*)

(\*) This value could be modified to 700  $\mu\text{g}\cdot\text{L}^{-1}$  in utilities using chlorine dioxide as disinfectant.

In this new directive, haloacetic acids might be limited to  $80 \mu\text{g}\cdot\text{L}^{-1}$  and both chlorites and chlorates might be limited to  $250 \mu\text{g}\cdot\text{L}^{-1}$ . Other families of unregulated DBPs such as nitrogenous DBPs (N-DBPs) are generally more toxic than THMs and HAAs (Wagner and Plewa, 2017), even their concentrations might be lower at drinking water systems (Farré et al., 2020). Measuring and modelling the occurrence of these compounds at full-scale DWTPs is costly, and most often, the laboratory analysis is difficult as there are no established protocols for measuring them in a routinely basis. We expect that this will change as techniques for measuring these compounds become available at a lesser cost and more data on the occurrence of these new compounds at DWTPs becomes available. Anyhow, it is expected that this will add complexity in DWTP management and therefore, predictive tools that are able to find a balance between treatment cost and DBPs formation could show their usefulness in ameliorating this process.

It is often the case that research on DBPs is some years ahead of what practitioners are actually concerned about. We think that more applied research should be done linking the research field with practical recommendations for operating full-scale plants, using the common technologies found in the existing utilities. Utilities do not often have the most recent technologies for advanced oxidation and removal of these compounds. Therefore, new tools should be developed to aid in this transition.

### ***Implementation of EDSS challenges***

In relation to the implementation of the EDSSs, this can only be validated through their use and feedback from users. Therefore, the real impact of the developed tools will be seen in the upcoming months or years. The transfer of the EDSS from the academia to the company is critical for a successful adoption of the system (Poch et al., 2017). The longevity of the project is dependent on the adoption and maintenance of the tool by the company. Future versions of the developed tools should consider using open source software that can be maintained by ATL or by other companies, so modifications can be done if deemed necessary or new modules can be added. This would underpin a successful transfer of the developed tool to the “market” or in this case, the ATL company.

Last, digitalisation is a transformative process among all water and wastewater utilities to face 21st century climatic, demographic and sustainability challenges. The development of digital technologies (including AI algorithms) in the sector can bring operational benefits such as process excellence, predictive maintenance and regulatory compliance (Sarni et al., 2019). All these technologies need strong digital strategies among companies that support integrated data infrastructures that allow the

development of analytic tools used for decision making. In this regards, digitalisation of utilities should be considered a business priority.

***Towards integrated management of drinking water systems***

Also, the present thesis aims to support the control and management of individual DWTPs. In a wider system such as ATL distribution network, that connects different DWTPs in a complex distribution network, an integrated approach for the management of the network would report benefits in making the most of managing the DWTPs taking a bigger picture of the problem. Efforts in this direction should be taken into account in future projects.









## 9. Conclusions



The present thesis focused on the development of environmental decision support systems for assisting DWTPs personnel in systematising their decision-making in setting the main operational set-points of the treatment process. This tool aimed to take into account the real-time variations of raw water quality to produce safe and high quality potable water at all times. To pursue this goal, two case studies using surface water were used and several treatment units were studied.

In **Chapter 4**, an artificial neural network was developed to predict the oxidant demand in the raw water of a Drinking Water Treatment plant has been developed using historical data from a full-scale facility. Moreover, uncertainty of the artificial neural network was quantified and compared to a case-based reasoning model for their implementation as control system. The presented framework makes a step forward in overcoming the blackbox nature of data-driven models and implementation in full-scale facilities.

**Chapter 5** reported on the development of a model for predicting the THMs formation at the distribution network. To these means, several data-driven models were benchmarked and then integrated in an EDSS for supporting the operation of the advanced treatment in Llobregat DWTP, composed by an electro dialysis reversal process. The presented system couples the predictive model with expert criteria, moving towards informed and predictive management of DWTPs. Thanks to this system, the effects of certain operation practices on the disinfection by-products exposure at different points of the water supply network can be quantified.

In **Chapter 6**, an EDSS for controlling the primary disinfection at Ter DWTP was developed. To this end, fuzzy inference systems were used to consolidate the accumulated experience of a process and systematise the decision-making taking into account the DBP formation. The developed system was tested against variations of raw water quality and was compared against similar periods without the control system. Fuzzy logic-based systems were shown useful where data is scarce or difficult to obtain, but there is a contrasted experience in managing a certain system. The developed system was implemented at full-scale and the systematisation of the decision making in the primary disinfection process was successfully achieved, maintaining disinfection by-products formation under acceptable levels.

Finally, in **Chapter 7**, the quantitative microbiological risk assessment (QMRA) framework was adapted to develop a key performance indicator assessing the safety of produced water at DWTPs, using Ter DWTP as case study. The proposed framework attempts to estimate the microbial risk of DWTPs' product water by assessing the performance of the different treatment units. The developed tool increases the level of

## *Chapter 9: Conclusions*

awareness of DWTPs in front of changes in raw water quality or short term treatment failures and their effects on the microbiological safety of treated water.

The developed models were integrated into a graphical user interface to help in daily operation of DWTPs. The overall performance of the EDSS was positively validated and permitted to do a step forward in the systematisation of process knowledge and data in utilities that are challenged by varying source water quality.

## 10. References



98/83/CE, 1998. Council Directive 98/83/EC of 3 November 1998 on the quality of water intended for human consumption.

Aamodt, A., Plaza, E., 1994. Case-Based Reasoning : Foundational Issues , Methodological Variations , and System Approaches. *AI Commun.* 7, 39–59.

Amy, G., Siddiqui, M., Ozekin, K., Zhu, H.W., Wang, C., 1998. Emperically based models for predicting chlorination and ozonation by-products: Haloacetic acids, chloral hydrate, and bromate, EPA report CX 819579.

Awad, J., Fisk, C.A., Cox, J.W., Anderson, S.J., van Leeuwen, J., 2018. Modelling of THM formation potential and DOM removal based on drinking water catchment characteristics. *Sci. Total Environ.* 635, 761–768.  
<https://doi.org/10.1016/j.scitotenv.2018.04.149>

Baker, A., Tipping, E., Thacker, S.A., Gondar, D., 2008. Relating dissolved organic matter fluorescence and functional properties. *Chemosphere* 73, 1765–1772.  
<https://doi.org/10.1016/j.chemosphere.2008.09.018>

Bastos, R.K.X., Viana, D.B., Bevilacqua, P.D., 2013. Turbidity as a surrogate for Cryptosporidium removal by filtration in drinking-water QMRA models. *Water Sci. Technol. Water Supply* 13, 1209–1219. <https://doi.org/10.2166/ws.2013.127>

Baxter, C.W., Stanley, S.J., Zhang, Q., Smith, D.W., 2002. Developing artificial neural network models of water treatment processes: a guide for utilities. *J. Environ. Eng. Sci.* 1, 201–211. <https://doi.org/10.1139/s02-014>

Baxter, Stanley, Zhang, 1999. Development of a full-scale artificial neural network model for the removal of natural organic matter by enhanced coagulation. *Aqua* 48, 129–136. <https://doi.org/10.1046/j.1365-2087.1999.00138.x>

Bello, O., Hamam, Y., Djouani, K., 2014. Modelling of a coagulation chemical dosing unit for water treatment plants using fuzzy inference system. *J. Water Process Eng.* 19, 3985–3991. <https://doi.org/10.3182/20140824-6-za-1003.02225>

Bichai, F., Smeets, P.W.M.H., 2013. Using QMRA-based regulation as a water quality management tool in the water security challenge : Experience from the Netherlands and Australia. *Water Res.* 7, 7315–7326.  
<https://doi.org/10.1016/j.watres.2013.09.062>

Boger, Z., 1992. Application of neural networks to water and wastewater treatment plant operation. *ISA Trans.* [https://doi.org/10.1016/0019-0578\(92\)90007-6](https://doi.org/10.1016/0019-0578(92)90007-6)

Boiocchi, R., Gernaey, K. V, Sin, G., 2016. Systematic design of membership functions



## Chapter 10: References

- for fuzzy-logic control : A case study on one-stage partial nitritation / anammox treatment systems 102, 346–361. <https://doi.org/10.1016/j.watres.2016.06.047>
- Borzoeei, S., Amerlinck, Y., Abolfathi, S., Panepinto, D., Nopens, I., Lorenzi, E., Meucci, L., Chiara, M., 2019. Data scarcity in modelling and simulation of a large-scale WWTP : Stop sign or a challenge. *J. Water Process Eng.* 28, 10–20. <https://doi.org/10.1016/j.jwpe.2018.12.010>
- Bowden, G.J., 2002. Optimal division of data for neural network models in water resources applications. *Water Resour. Res.* 38. <https://doi.org/10.1029/2001WR000266>
- Bowden, G.J., Dandy, G.C., Maier, H.R., 2005. Input determination for neural network models in water resources applications. Part 1 - Background and methodology. *J. Hydrol.* 301, 75–92. <https://doi.org/10.1016/j.jhydrol.2004.06.021>
- Brun, R., Reichert, P., Künsch, H.R., 2001. Practical identifiability analysis of large environmental simulation models. *Water Resour. Res.* 37, 1015–1030. <https://doi.org/10.1029/2000WR900350>
- Castillo, A., Cheali, P., Gómez, V., Comas, J., Poch, M., Sin, G., 2016. An integrated knowledge-based and optimization tool for the sustainable selection of wastewater treatment process concepts. *Environ. Model. Softw.* 84, 177–192. <https://doi.org/10.1016/j.envsoft.2016.06.019>
- Chang, C.Y., Hsieh, Y.H., Hsu, S.S., Hu, P.Y., Wang, K.H., 2000. The formation of disinfection by-products in water treated with chlorine dioxide. *J. Hazard. Mater.* 79, 89–102. [https://doi.org/10.1016/S0304-3894\(00\)00184-9](https://doi.org/10.1016/S0304-3894(00)00184-9)
- Choi, J., Valentine, R.L., 2002. Formation of N -nitrosodimethylamine ( NDMA ) from reaction of monochloramine : a new disinfection by-product. *Water Res.* 36, 817–824.
- Chowdhury, S., 2012. Decision making with uncertainty: An example of water treatment approach selection. *Water Qual. Res. J. Canada.* <https://doi.org/10.2166/wqrjc.2012.107>
- Chowdhury, S., Champagne, P., Husain, T., 2007. Fuzzy risk-based decision-making approach for selection of drinking water disinfectants. *J. Water Supply Res. Technol.* 75–93. <https://doi.org/10.2166/aqua.2007.090>
- Chowdhury, S., Champagne, P., Mclellan, P.J., 2009. Models for predicting disinfection byproduct ( DBP ) formation in drinking waters : A chronological review. *Sci. Total Environ.* 407, 4189–4206. <https://doi.org/10.1016/j.scitotenv.2009.04.006>
- Colthurst, J.M., Singer, P.C., 1982. Removing Trihalomethane Precursors By

- Permanganate Oxidation and Manganese Dioxide Adsorption. J. / Am. Water Work. Assoc. 74, 78–83. <https://doi.org/10.1002/j.1551-8833.1982.tb04853.x>
- Comas, J., Alemany, J., Poch, M., Torrens, A., Salgot, M., Bou, J., 2004. Development of a knowledge-based decision support system for identifying adequate wastewater treatment for small communities. *Water Sci. Technol.* 48, 393–400. <https://doi.org/10.2166/wst.2004.0887>
- Comas, J., Meabe, E., Sancho, L., Ferrero, G., Sipma, J., Monclús, H., Rodríguez-Roda, I., 2010. Knowledge-based system for automatic MBR control. *Water Sci. Technol.* 62, 2829–2836. <https://doi.org/10.2166/wst.2010.693>
- Cool, G., Delpla, I., Gagnon, P., Lebel, A., Sadiq, R., Rodríguez, M.J., 2019. Climate change and drinking water quality: Predicting high trihalomethane occurrence in water utilities supplied by surface water. *Environ. Model. Softw.* 120, 104479. <https://doi.org/10.1016/j.envsoft.2019.07.004>
- Corominas, L., Garrido-Baserba, M., Villegas, K., Olsson, G., Cortés, U., Poch, M., 2017. Transforming data into knowledge for improved wastewater treatment operation: A critical review of techniques. *Environ. Model. Softw.* <https://doi.org/10.1016/j.envsoft.2017.11.023>
- Cortés, U., Sánchez-Marrè, M., Ceccaroni, L., Rodríguez-Roda, I., Poch, M., 2000. Artificial Intelligence and Environmental Decision Support Systems. *Appl. Intell.* 13, 77–91. <https://doi.org/10.1.1.20.6267>
- Crittenden, J.C., Trussell, R.R., Hand, D.W., Howe, K.J., Tchobanoglous, G., 2012. MWH's Water Treatment: Principles and Design: Third Edition, in: MWH's Water Treatment: Principles and Design: Third Edition. Hoboken, New Jersey, pp. 903–1032. <https://doi.org/10.1002/9781118131473>
- Delpla, I., Jung, A., Baures, E., Clement, M., Thomas, O., 2009. Impacts of climate change on surface water quality in relation to drinking water production. *Environ. Int.* 35, 1225–1233. <https://doi.org/10.1016/j.envint.2009.07.001>
- Efron, B., 1979. Bootstrap methods: Another look at the jackknife. *Ann. Stat.* 7, 1–26.
- Farré, M.J., Insa, S., Lamb, A., Cojocariu, C., Gernjak, W., 2020. Occurrence of N-nitrosamines and their plants and distribution systems †. *Environ. Sci. Water Res. Technol.* 6, 210–220. <https://doi.org/10.1039/C9EW00912D>
- Fernández-Turiel, J.L., Llorens, J.F., Roig, A., Carnicero, M., Valero, F., 2000. Monitoring of drinking water treatment plants using ICP-MS. *Toxicol. Environ. Chem.* 74, 87–103. <https://doi.org/10.1080/02772240009358871>
- Fernández-Turiel, J. L., Llorens, J.F., Roig, A., Carnicero, M., Valero, F., 2000. Monitoring

## Chapter 10: References

- of drinking water treatment plants using ICP-MS. *Toxicol. Environ. Chem.* 74, 87–103. <https://doi.org/10.1080/02772240009358871>
- Frutiger, J., Abildskov, J., Sin, G., 2015. Outlier treatment for improving parameter estimation of group contribution based models for upper flammability limit. *Comput. Aided Chem. Eng.* 37, 503–508. <https://doi.org/10.1016/B978-0-444-63578-5.50079-7>
- Frutiger, J., Marcarie, C., Abildskov, J., Sin, G., 2016. A Comprehensive Methodology for Development, Parameter Estimation, and Uncertainty Analysis of Group Contribution Based Property Models-An Application to the Heat of Combustion. *J. Chem. Eng. Data* 61, 602–613. <https://doi.org/10.1021/acs.jced.5b00750>
- Gale, B.Y.P., 2002. Using risk assessment to identify future research requirements. *Curr. Issues. Am. Water Work. Assoc.* 30–38.
- Gass, S.I., 1983. Decision-Aiding Models: Validation, Assessment, and Related Issues for Policy Analysis. *Oper. Res.* 31, 603–631. <https://doi.org/10.1287/opre.31.4.603>
- Gibert, K., Izquierdo, J., Sánchez-marrè, M., Hamilton, S.H., Rodríguez-roda, I., Holmes, G., 2018. Which method to use? An assessment of data mining methods in Environmental Data Science. *Environ. Model. Softw.* 110, 3–27. <https://doi.org/10.1016/j.envsoft.2018.09.021>
- Gibert, K., Rodríguez-Silva, G., Rodríguez-Roda, I., 2010. Knowledge discovery with clustering based on rules by states : A water treatment application 25, 712–723. <https://doi.org/10.1016/j.envsoft.2009.11.004>
- Gibert, K., Sánchez-Marrè, M., Izquierdo, J., 2016. A survey on pre-processing techniques: Relevant issues in the context of environmental data mining. *AI Commun.* 29, 627–663. <https://doi.org/10.3233/AIC-160710>
- Godo-Pla, L., Emiliano, P., Valero, F., Poch, M., Sin, G., Monclús, H., 2019. Predicting the oxidant demand in full-scale drinking water treatment using an artificial neural network : Uncertainty and sensitivity analysis. *Process Saf. Environ. Prot.* 125, 317–327. <https://doi.org/10.1016/j.psep.2019.03.017>
- Golea, D.M., Upton, A., Jarvis, P., Moore, G., Sutherland, S., Parsons, S.A., Judd, S.J., 2017. THM and HAA formation from NOM in raw and treated surface waters. *Water Res.* 112, 226–235. <https://doi.org/10.1016/j.watres.2017.01.051>
- Golfinopoulos, S.K., Xilourgidis, N.K., Kostopoulou, M.N., Lekkas, T.D., 1998. Use of a multiple regression model for predicting trihalomethane formation. *Water Res.* 32, 2821–2829. [https://doi.org/10.1016/S0043-1354\(98\)00022-0](https://doi.org/10.1016/S0043-1354(98)00022-0)
- Griffiths, K.A., Andrews, R.C., 2011. The application of artificial neural networks for the

- optimization of coagulant dosage. *Water Sci. Technol. Water Supply* 11, 605–611. <https://doi.org/10.2166/ws.2011.028>
- Haghiri, S., Daghighi, A., Moharramzadeh, S., 2017. Optimum Coagulant Forecasting with Modeling the Jar Test Experiments Using ANN. *Drink. Water Eng. Sci.* 1–12.
- Hamouda, M.A., Anderson, W.B., Huck, P.M., 2009. Decision support systems in water and wastewater treatment process selection and design: A review. *Water Sci. Technol.* 60, 1767–1770. <https://doi.org/10.2166/wst.2009.538>
- Hamouda, M.A., Anderson, W.B., Van Dyke, M.I., Douglas, I.P., McFadyen, S.D., Huck, P.M., 2016. Scenario-based quantitative microbial risk assessment to evaluate the robustness of a drinking water treatment plant. *Water Qual. Res. J. Canada* 51, 81–96. <https://doi.org/10.2166/wqrjc.2016.034>
- Havelaar, A.H., Melse, J.M., 2003. Quantifying public health risk in the WHO Guidelines for Drinking-water Quality: a burden of disease approach. Bilthoven: National Institute for Public Health and the Environment (RIVM Report 734301022/2003 1–49).
- Hawari, A.H., Alnahhal, W., 2016. Predicting the performance of multi-media filters using artificial neural networks. *Water Sci. Technol.* 74, 2225–2233. <https://doi.org/10.2166/wst.2016.380>
- Hidayah, E.N., Yeh, H.H., 2018. Effect of Permanganate Preoxidation to Natural Organic Matter and Disinfection by-Products Formation Potential Removal. *J. Phys. Conf. Ser.* 953. <https://doi.org/10.1088/1742-6596/953/1/012218>
- Hu, J., Chu, W., Sui, M., Xu, B., Gao, N., Ding, S., 2018. Comparison of drinking water treatment processes combinations for the minimization of subsequent disinfection by-products formation during chlorination and chloramination. *Chem. Eng. J.* 335, 352–361. <https://doi.org/10.1016/j.cej.2017.10.144>
- Humphrey, G., Maier, H.R., Wu, W., Mount, N.J., Dandy, G.C., Abraham, R.J., Dawson, C.W., 2017. Improved validation framework and R-package for artificial neural network models. *Environ. Model. Softw.* 92, 82–106. <https://doi.org/10.1016/j.envsoft.2017.01.023>
- James, G., Witten, D., Hastie, T., Tibshirani, R., 2013. *An Introduction to Statistical Learning with Applications in R*, Springer. <https://doi.org/10.1016/j.peva.2007.06.006>
- Jeong, B., Oh, M.S., Park, H.M., Park, C., Kim, E.J., Hong, S.W., Kim, E.J., 2017. Elimination of microcystin-LR and residual Mn species using permanganate and powdered activated carbon: Oxidation products and pathways. *Water Res.* 114, 189–199. <https://doi.org/10.1016/j.watres.2017.02.043>

## Chapter 10: References

- Kamble, S.S., Gunasekaran, A., Gawankar, S.A., 2018. Sustainable Industry 4 . 0 framework : A systematic literature review identifying the current trends and future perspectives. *Process Saf. Environ. Prot.* 117, 408–425. <https://doi.org/10.1016/j.psep.2018.05.009>
- Kelly, R.A., Jakeman, A.J., Barreteau, O., Borsuk, M.E., ElSawah, S., Hamilton, S.H., Henriksen, H.J., Kuikka, S., Maier, H.R., Rizzoli, A.E., van Delden, H., Voinov, A.A., 2013. Selecting among five common modelling approaches for integrated environmental assessment and management. *Environ. Model. Softw.* 47, 159–181. <https://doi.org/10.1016/j.envsoft.2013.05.005>
- Kennedy, M.J., Gandomi, A.H., Miller, C.M., 2015. Coagulation modeling using artificial neural networks to predict both turbidity and DOM-PARAFAC component removal. *J. Environ. Chem. Eng.* 3, 2829–2838. <https://doi.org/10.1016/j.jece.2015.10.010>
- Kim, M.S., Lee, H.J., Lee, K.M., Seo, J., Lee, C., 2018. Oxidation of Microcystins by Permanganate: PH and Temperature-Dependent Kinetics, Effect of DOM Characteristics, and Oxidation Mechanism Revisited. *Environ. Sci. Technol.* 52, 7054–7063. <https://doi.org/10.1021/acs.est.8b01447>
- Kragt, M.E., 2009. A beginners guide to Bayesian network modelling for integrated catchment management. *Landsc. Log.*
- Krueger, T., Page, T., Hubacek, K., Smith, L., Hiscock, K., 2012. The role of expert opinion in environmental modelling. *Environ. Model. Softw.* 36, 4–18. <https://doi.org/10.1016/j.envsoft.2012.01.011>
- Kulkarni, P., Chellam, S., 2010. Disinfection by-product formation following chlorination of drinking water: Artificial neural network models and changes in speciation with treatment. *Sci. Total Environ.* 408, 4202–4210. <https://doi.org/10.1016/j.scitotenv.2010.05.040>
- Kuster, M., López de Alda, M.J., Hernando, M.D., Petrovic, M., Martín-Alonso, J., Barceló, D., 2008. Analysis and occurrence of pharmaceuticals , estrogens , progesterones and polar pesticides in sewage treatment plant effluents , river water and drinking water in the Llobregat river basin (Barcelona, Spain). *J. Hydrol.* 112–123. <https://doi.org/10.1016/j.jhydrol.2008.05.030>
- Lamrini, B., Lakhali, E.K., Lann, M.V. Le, 2014. A decision support tool for technical processes optimization in drinking water treatment. *Desalin. Water Treat.* 52, 4079–4088. <https://doi.org/10.1080/19443994.2013.803327>
- LeChevallier, M.W., Norton, D., 1992. Examining Relationships Between Particle Counts and Giardia , Cryptosporidium , and Turbidity. *J. Am. Water Work. Assoc.* 54–60.

- <https://doi.org/10.1002/j.1551-8833.1992.tb05902.x>
- Li, X., Mitch, W.A., 2018. Drinking Water Disinfection Byproducts (DBPs) and Human Health Effects: Multidisciplinary Challenges and Opportunities. *Environ. Sci. Technol.* 52, 1681–1689. <https://doi.org/10.1021/acs.est.7b05440>
- Lin, J., Chen, X., Ansheng, Z., Hong, H., Liang, Y., Sun, H., Lin, H., Chen, J., 2018. Regression models evaluating THMs, HAAs and HANs formation upon chloramination of source water collected from Yangtze River Delta Region, China. *Ecotoxicol. Environ. Saf.* 160, 249–256. <https://doi.org/10.1016/j.ecoenv.2018.05.038>
- Maier, H.R., Dandy, G.C., 2000. Neural Network for the prediction and forecasting of water resources variables: a review of modeling issues and application. *Environ. Model. Softw.* 15, 101–124.
- Maier, H.R., Jain, A., Dandy, G.C., Sudheer, K.P., 2010. Methods used for the development of neural networks for the prediction of water resource variables in river systems: Current status and future directions. *Environ. Model. Softw.* 25, 891–909. <https://doi.org/10.1016/j.envsoft.2010.02.003>
- Maier, H.R., Morgan, N., Chow, C.W.K., 2004. Use of artificial neural networks for predicting optimal alum doses and treated water quality parameters. *Environ. Model. Softw.* 19, 485–494. [https://doi.org/10.1016/S1364-8152\(03\)00163-4](https://doi.org/10.1016/S1364-8152(03)00163-4)
- Makropoulos, C., 2019. Urban Hydroinformatics: Past, Present and Future. *Water (Switzerland)* 11, 1959. <https://doi.org/10.3390/w11101959>
- Mamdani, E.H., Assilian, S., 1999. An Experiment in Linguistic Sythesis with a Fuzzy Logic Controller. *Int. J. Man. Mach. Stud.* 7(1), 1–13.
- Mannina, G., Rebouças, T.F., Cosenza, A., Sánchez-marrè, M., Gibert, K., 2019. Decision support systems ( DSS ) for wastewater treatment plants – A review of the state of the art. *Bioresour. Technol.* 121814. <https://doi.org/10.1016/j.biortech.2019.121814>
- May, R.J., Dandy, G.C., Maier, H.R., Nixon, J.B., 2008. Application of partial mutual information variable selection to ANN forecasting of water quality in water distribution systems. *Environ. Model. Softw.* 23, 1289–1299. <https://doi.org/10.1016/j.envsoft.2008.03.008>
- May, R.J., Maier, H.R., Dandy, G.C., 2010. Data splitting for artificial neural networks using SOM-based stratified sampling. *Neural Networks* 23, 283–294. <https://doi.org/10.1016/j.neunet.2009.11.009>
- McIntosh, B.S., Ascough, J.C., Twery, M., Chew, J., Elmahdi, A., Haase, D., Harou, J.J.,

## Chapter 10: References

- Hepting, D., Cuddy, S., Jakeman, A.J., Chen, S., Kassahun, A., Lautenbach, S., Matthews, K., Merritt, W., Quinn, N.W.T., Rodriguez-Roda, I., Sieber, S., Stavenga, M., Sulis, A., Ticehurst, J., Volk, M., Wrobel, M., van Delden, H., El-Sawah, S., Rizzoli, A., Voinov, A., 2011. Environmental decision support systems (EDSS) development - Challenges and best practices. *Environ. Model. Softw.* 26, 1389–1402. <https://doi.org/10.1016/j.envsoft.2011.09.009>
- Medema, G., Loret, J.-. F., Stenström, T.A., Ashbolt, N., 2006. Quantitative Microbial Risk Assessment in the Water Safety Plan. Final Report on the EU MicroRisk Project.
- Mohammed, H., Seidu, R., 2019. Climate-driven QMRA model for selected water supply systems in Norway accounting for raw water sources and treatment processes. *Sci. Total Environ.* 660, 306–320. <https://doi.org/10.1016/j.scitotenv.2018.12.460>
- Montemayor, M., Valero, F., Jofre, J., Lucena, F., 2005. Occurrence of *Cryptosporidium* spp . oocysts in raw and treated sewage and river water in north-eastern Spain 1455–1462. <https://doi.org/10.1111/j.1365-2672.2005.02737.x>
- Mujeriego, R., Gullón, M., Lobato, S., 2017. Incidental potable water reuse in a Catalanian basin: living downstream. *J. Water Reuse Desalin.* 7, 253–263. <https://doi.org/10.2166/wrd.2016.199>
- Naceradska, J., Pivokonsky, M., Pivokonska, L., Baresova, M., Henderson, R.K., Zamyadi, A., Janda, V., 2017. The impact of pre-oxidation with potassium permanganate on cyanobacterial organic matter removal by coagulation. *Water Res.* 114, 42–49. <https://doi.org/10.1016/j.watres.2017.02.029>
- Nieminski, E.C., Ongerth, J.E., 1995. Removing *Giardia* and *Cryptosporidium* by conventional treatment and direct filtration. *J. Am. Water Work. Assoc.* 96–106. <https://doi.org/10.1002/j.1551-8833.1995.tb06426.x>
- Nikolaou, A.D., Golfopoulos, S.K., Arhonditsis, G.B., Kolovoyiannis, V., Lekkas, T.D., 2004. Modeling the formation of chlorination by-products in river waters with different quality. *Chemosphere* 55, 409–420. <https://doi.org/10.1016/j.chemosphere.2003.11.008>
- Núñez, H., Sánchez-Marrè, M., Cortés, U., Comas, J., Martínez, M., Rodríguez-Roda, I., Poch, M., 2003. A comparative study on the use of similarity measures in case-based reasoning to improve the classification of environmental system situations. *Environ. Model. Softw.* 19, 809–819. <https://doi.org/10.1016/j.envsoft.2003.03.003>
- Olden, J.D., Jackson, D.A., 2002. Illuminating the “black box”: A randomization approach for understanding variable contributions in artificial neural networks.

- Ecol. Modell. 154, 135–150. [https://doi.org/10.1016/S0304-3800\(02\)00064-9](https://doi.org/10.1016/S0304-3800(02)00064-9)
- Oliveira, M.D. de, Rezende, O.L.T. de, Fonseca, J.F.R. de, Libânio, M., 2019. Evaluating the surface Water quality index fuzzy and its influence on water treatment. *J. Water Process Eng.* 32, 100890. <https://doi.org/10.1016/j.jwpe.2019.100890>
- Owens, C.E.L., Angles, M.L., Cox, P.T., Byleveld, P.M., Osborne, N.J., Rahman, B., 2020. Implementation of quantitative microbial risk assessment ( QMRA ) for public drinking water supplies : Systematic review. *Water Res.* 174, 115614. <https://doi.org/10.1016/j.watres.2020.115614>
- Panidhapu, A., Li, Z., 2020. Integration of weather conditions for predicting microbial water quality using Bayesian Belief Networks. *Water Res.* 170, 115349. <https://doi.org/10.1016/j.watres.2019.115349>
- Pecson, B.M., Triolo, S.C., Olivieri, S., Chen, E.C., Pisarenko, A.N., Yang, C., Olivieri, A., Haas, C.N., Trussell, R.S., Trussell, R.R., 2017. Reliability of pathogen control in direct potable reuse : Performance evaluation and QMRA of a full-scale 1 MGD advanced treatment train 122, 258–268. <https://doi.org/10.1016/j.watres.2017.06.014>
- Pike, W.A., 2004. Modeling drinking water quality violations with Bayesian networks. *J. Am. Water Resour. Assoc.* December, 1563–1578. <https://doi.org/10.1111/j.1752-1688.2004.tb01606.x>
- Platikanov, S., Puig, X., Martín, J., Tauler, R., 2007. Chemometric modeling and prediction of trihalomethane formation in Barcelona’s water works plant. *Water Res.* 41, 3394–3406. <https://doi.org/10.1016/j.watres.2007.04.015>
- Poch, M., Comas, J., Cortés, U., Sànchez-Marrè, M., Rodríguez-Roda, I., 2017. Crossing the Death Valley to Transfer Environmental Decision Support Systems to the Water Market. *Glob. Challenges* 1, 1700009. <https://doi.org/10.1002/gch2.201700009>
- Poch, M., Comas, J., Rodríguez-Roda, I., Sànchez-Marrè, M., Cortés, U., 2004. Designing and building real environmental decision support systems. *Environ. Model. Softw.* 19, 857–873. <https://doi.org/10.1016/j.envsoft.2003.03.007>
- Purnell, S., Halliday, A., Newman, F., Sinclair, C., Ebdon, J., 2020. Pathogen infection risk to recreational water users, associated with surface waters impacted by de facto and indirect potable reuse activities. *Sci. Total Environ.* 722, 137799. <https://doi.org/10.1016/j.scitotenv.2020.137799>
- Raich-Montiu, J., Barios, J., Garcia, V., Medina, M.E., Valero, F., Devesa, R., Cortina, J.L., 2014. Integrating membrane technologies and blending options in water production and distribution systems to improve organoleptic properties. The case



## Chapter 10: References

- of the Barcelona Metropolitan Area. *J. Clean. Prod.* 69, 250–259. <https://doi.org/10.1016/j.jclepro.2014.01.032>
- Raseman, W.J., Kasprzyk, J.R., Rosario-Ortiz, F.L., Stewart, J.R., Livneh, B., 2017. Emerging investigators series: a critical review of decision support systems for water treatment: making the case for incorporating climate change and climate extremes. *Environ. Sci. Water Res. Technol.* 3, 18–36. <https://doi.org/10.1039/C6EW00121A>
- RD 140/2003, n.d. Royal Decree of 7th February of 2003 by which health criteria for the quality of water intended for human consumption are established. BOE 45, 7228-7245, Madrid, Spain.
- Rieger, L., Olsson, G., 2012. Why many control systems fail. *Water Environ. Technol. Water Environ. Fed.* 42–45.
- Rivadeneira, A., García-Ruiz, M.J., Delgado-Ramos, F., González-Martínez, A., Osorio, F., Rabaza, O., 2014. Feasibility study of a simple and low-cost device for monitoring trihalomethanes presence in water supply systems based on statistical models. *Water (Switzerland)* 6, 3590–3602. <https://doi.org/10.3390/w6123590>
- Robles, A., Capson-Tojo, G., Ruano, M. V., Latrille, E., Steyer, J.P., 2018. Development and pilot-scale validation of a fuzzy-logic control system for optimization of methane production in fixed-bed reactors. *J. Process Control* 68, 96–104. <https://doi.org/10.1016/j.jprocont.2018.05.007>
- Rodríguez-Roda, I.R., Sánchez-Marrè, M., Comas, J., Baeza, J., Colprim, J., Lafuente, J., Cortes, U., Poch, M., 2002. A hybrid supervisory system to support WWTP operation: Implementation and validation. *Water Sci. Technol.* 45, 289–297.
- Rodríguez, E., Majado, M.E., Meriluoto, J., Acero, J.L., 2007. Oxidation of microcystins by permanganate: Reaction kinetics and implications for water treatment. *Water Res.* 41, 102–110. <https://doi.org/10.1016/j.watres.2006.10.004>
- Rodríguez, M.J., Sérodes, J.-B., 2004. Application of back-propagation neural network modeling for free residual chlorine, total trihalomethanes and trihalomethanes speciation. *J. Environ. Eng. Sci.* 3, S25–S34. <https://doi.org/10.1139/s03-069>
- Sadiq, R., Rodríguez, M.J., 2004. Disinfection by-products (DBPs) in drinking water and predictive models for their occurrence: A review. *Sci. Total Environ.* 321, 21–46. <https://doi.org/10.1016/j.scitotenv.2003.05.001>
- Sadiq, R., Rodríguez, M.J., Mian, H.R., 2019. Empirical models to predict disinfection by-products (DBPs) in drinking water: An updated review, 2nd ed, *Encyclopedia of Environmental Health*. Elsevier Inc. <https://doi.org/10.1016/B978-0-12-409548-9.11193-5>

- Sánchez-Marrè, M., Cortés, U., R-Roda, I., Poch, M., Lafuente, J., 1997. Learning and adaptation in wastewater treatment plants through case-based reasoning. *Comput. Civ. Infrastruct. Eng.* 12, 251–266. <https://doi.org/10.1111/0885-9507.00061>
- Sarle, W.S., 2000. How to measure importance of inputs ? [WWW Document]. URL <ftp://ftp.sas.com/pub/neural/importance.html>
- Sarni, W., White, C., Webb, R., Cross, K., Glotzbach, R., 2019. *Digital Water*. Industry leaders chart the transformation journey. London, UK.
- Savic, D., 2020. Developing the digital water toolbox. *Source. IWA Publ.* 10–13.
- Sharma, V.K., Triantis, T.M., Antoniou, M.G., He, X., Pelaez, M., Han, C., Song, W., O’Shea, K.E., De La Cruz, A.A., Kaloudis, T., Hiskia, A., Dionysiou, D.D., 2012. Destruction of microcystins by conventional and advanced oxidation processes: A review. *Sep. Purif. Technol.* 91, 3–17. <https://doi.org/10.1016/j.seppur.2012.02.018>
- Sillanpää, M., Ncibi, M.C., Matilainen, A., Vepsäläinen, M., 2018. Removal of natural organic matter in drinking water treatment by coagulation: A comprehensive review. *Chemosphere* 190, 54–71. <https://doi.org/10.1016/j.chemosphere.2017.09.113>
- Sin, G., Gernaey, K. V., 2016. Data Handling and Parameter Estimation, in: *Experimental Methods in Wastewater Treatment*. IWA Publishing, pp. 201–234. <https://doi.org/10.1017/CBO9781107415324.004>
- Sin, G., Gernaey, K. V., Lantz, A.E., 2009. Good modelling practice (GMoP) for PAT applications: Propagation of input uncertainty and sensitivity analysis. *Biotechnol. Prog.* 25, 1043–1053. <https://doi.org/10.1021/bp.166>
- Singer, P.C., 1994. Control of disinfection by-products in drinking water. *J. Environ. Eng. (United States)*. [https://doi.org/10.1061/\(ASCE\)0733-9372\(1994\)120:4\(727\)](https://doi.org/10.1061/(ASCE)0733-9372(1994)120:4(727))
- Stock, T., Obenaus, M., Kunz, S., Kohl, H., 2018. Industry 4.0 as Enabler for a Sustainable Development: A Qualitative Assessment of its Ecological and Social Potential. *Process Saf. Environ. Prot.* <https://doi.org/10.1016/j.psep.2018.06.026>
- Suquet, J., Godo-Pla, L., Valentí, M., Verdaguer, M., Martin, M.J., Poch, M., Monclús, H., 2020. Development of an Environmental Decision Support System for enhanced coagulation in drinking water production. *Water (Switzerland)* 12, 2115.
- Teunis, P.F.M., Medema, G.J., Kruidenier, L., Havelaar, A.H., 1997. Assessment of the risk of infection by *Cryptosporidium* or *Giardia* in drinking water from a surface water source. *Water Res.* 31, 1333–1346. [151](https://doi.org/10.1016/S0043-</a></p></div><div data-bbox=)

## Chapter 10: References

1354(96)00387-9

- Teunis, P.F.M., Rutjes, S.A., Westrell, T., de Roda Husman, A.M., 2009. Characterization of drinking water treatment for virus risk assessment. *Water Res.* 43, 395–404. <https://doi.org/10.1016/j.watres.2008.10.049>
- Tolouei, S., Dewey, R., Snodgrass, W.J., Edge, T.A., Andrews, R.C., Taghipour, M., Prévost, M., Dorner, S., 2019. Assessing microbial risk through event-based pathogen loading and hydrodynamic modelling. *Sci. Total Environ.* 693. <https://doi.org/10.1016/j.scitotenv.2019.07.373>
- Tomperi, J., Pelo, M., Leiviskä, K., 2013. Predicting the residual aluminum level in water treatment process. *Drink. Water Eng. Sci.* 6, 39–46. <https://doi.org/10.5194/dwes-6-39-2013>
- Tryland, I., Eregno, F.E., 2015. On-Line Monitoring of Escherichia coli in Raw Water at Oset Drinking Water Treatment Plant , Oslo ( Norway ). <https://doi.org/10.3390/ijerph120201788>
- Upton, A., Jefferson, B., Moore, G., Jarvis, P., 2017. Rapid gravity filtration operational performance assessment and diagnosis for preventative maintenance from on-line data. *Chem. Eng. J.* 313, 250–260. <https://doi.org/10.1016/j.cej.2016.12.047>
- USEPA, 2016. Online Source Water Quality Monitoring for Water Quality Surveillance and Response Systems.
- USEPA, 2003. LT1ESWTR Disinfection Profiling and Benchmarking Technical Guidance Manual.
- USEPA, 1998. National Primary Drinking Water Regulations: Interim Enhanced Surface Water Treatment Final Rule. Washington, DC.
- Valero, F., Arbós, R., 2010. Desalination of brackish river water using Electrodialysis Reversal (EDR). Control of the THMs formation in the Barcelona (NE Spain) area. *Desalination* 253, 170–174. <https://doi.org/10.1016/j.desal.2009.11.011>
- Valero, F., Barceló, A., Medina, M.E., Arbós, R., 2013. Barcelona, three years of experience in brackish water desalination using edr to improve quality. new O&M procedures to reduce low-value work and increase productivity. *Desalin. Water Treat.* 51, 1137–1142. <https://doi.org/10.1080/19443994.2012.714583>
- Wagner, E.D., Plewa, M.J., 2017. CHO cell cytotoxicity and genotoxicity analyses of disinfection by-products: An updated review. *J. Environ. Sci. (China)* 58, 64–76. <https://doi.org/10.1016/j.jes.2017.04.021>
- Walling, E., Vaneckhaute, C., 2020. Developing successful environmental decision

- support systems : Challenges and best practices. *J. Environ. Manage.* 264. <https://doi.org/10.1016/j.jenvman.2020.110513>
- Weisman, R.J., Barber, L.B., Rapp, J.L., Ferreira, C.M., 2019. De facto reuse and disinfection by-products in drinking water systems in the Shenandoah River watershed. *Environ. Sci. Water Res. Technol.* 5, 1699–1708. <https://doi.org/10.1039/C9EW00326F>
- WHO, 2000. Chemistry of Disinfectants and Disinfectant By-Products. EHC 216 Disinfect. Disinfect. By- Prod.
- World Health Organization, 2017. Guidelines for drinking-water quality: fourth edition incorporating first addendum, 4th ed + 1st add. World Health Organization, Geneva. World Health Organization, Geneva.
- World Health Organization, 2016. Quantitative microbial risk assessment: Application for water safety management, Routledge Handbook of Water and Health. World Health Organization. <https://doi.org/10.4324/9781315693606>
- World Health Organization, 2009. Risk Assessment of Cryptosporidium in Drinking Water. Water, Sanitation and Health Team. World Health Organization. <https://apps.who.int/iris/handle/10665/70117>.
- World Health Organization, 2004. Water Treatment and Pathogen Control: Process Efficiency in Achieving Safe Drinking Water. IWA Publishing, London, UK.
- Worm, G.I.M., van der Helm, A.W.C., Lapikas, T., van Schagen, K.M., Rietveld, L.C., 2010. Integration of models, data management, interfaces and training support in a drinking water treatment plant simulator. *Environ. Model. Softw.* 25, 677–683. <https://doi.org/10.1016/j.envsoft.2009.05.011>
- Wu, G. De, Lo, S.L., 2008. Predicting real-time coagulant dosage in water treatment by artificial neural networks and adaptive network-based fuzzy inference system. *Eng. Appl. Artif. Intell.* 21, 1189–1195. <https://doi.org/10.1016/j.engappai.2008.03.015>
- Wu, W., Dandy, G.C., Maier, H.R., 2014. Protocol for developing ANN models and its application to the assessment of the quality of the ANN model development process in drinking water quality modelling. *Environ. Model. Softw.* 54, 108–127. <https://doi.org/10.1016/j.envsoft.2013.12.016>
- Wu, W., Dandy, G.C., Maier, H.R., 2011. Application of artificial neural networks to forecasting water quality in a chloraminated water distribution system. MODSIM 2011 - 19th Int. Congr. Model. Simul. - Sustain. Our Futur. Underst. Living with Uncertain. 1112–1118. <https://doi.org/10.36334/modsim.2011.c1.wu>

## Chapter 10: References

- Yang, X., Guo, W., Zhang, X., Chen, F., Ye, T., Liu, W., 2013. Formation of disinfection by-products after pre-oxidation with chlorine dioxide or ferrate. *Water Res.* 47, 5856–5864. <https://doi.org/10.1016/j.watres.2013.07.010>
- Yuan, Z., Olsson, G., Cardell-oliver, R., Schagen, K. Van, Marchi, A., Deletic, A., Urich, C., Rauch, W., Liu, Y., 2019. Sweating the assets e The role of instrumentation , control and automation in urban water systems. *Water Res.* 155, 381–402. <https://doi.org/10.1016/j.watres.2019.02.034>
- Zhang, K., Zargar, A., Achari, G., Islam, M.S., Sadiq, R., 2014. Application of decision support systems in water management. *Environ. Rev.* 22, 189–205. <https://doi.org/10.1139/er-2013-0034>
- Zhang, L., Ma, J., Li, X., Wang, S., 2009. Enhanced removal of organics by permanganate preoxidation using tannic acid as a model compound - Role of in situ formed manganese dioxide. *J. Environ. Sci.* 21, 872–876. [https://doi.org/10.1016/S1001-0742\(08\)62355-4](https://doi.org/10.1016/S1001-0742(08)62355-4)

## 11. Annexes



## Annex I

## A1.1. MATLAB functions

**Table A 1.** Descriptions of MATLAB functions.

<b>MATLAB function</b>	<b>Description</b>
corr(X)	Returns a matrix of the pairwise linear correlation between variables in the input matrix of size ( $m \times n$ ), where $m$ is the number of observations and $n$ is the number of independent variables.
cov(X)	Returns the covariance matrix of input matrix of size ( $m \times n$ ), where $m$ is the number of observations and $n$ is the number of independent variables.
ecdf(y)	Returns the empirical cumulative distribution function using data of the input vector.
fitlm()	Fits a linear regression model to variables in input matrix $X$ of size ( $m \times n$ ), where $m$ is the number of observations and $n$ is the number of independent variables, and vector $y$ (dependent variable). Model specifications can be formulated when calling to this function, such as robust regression options or model type options (linear, quadratic, interceptions...). The output of this function is an object containing the linear model attributes and characteristics.
ksdensity()	Returns a probability density estimate $f$ , for the sample data in the input vector $x$ . This estimate is based on a normal kernel function and evaluated at equally-spaced points, covering the range of data in $x$ .
lsqnonlin()	Solver for nonlinear least-squares curve fitting problems. The inputs needed for using this solver are a function $fun$ to optimise and a vector $x_0$ with initial values for starting the iterations. The output of this solver is a vector $x$ that minimise the optimisation function $fun$ . Additional characteristics such as maximum number of iterations and constraints to the parameter estimation problem can be added.



mvnrnd()	Returns a matrix of random vectors chosen from the multivariate normal distribution with mean vector <i>mu</i> and covariance matrix <i>sigma</i> .
nlinfit()	Returns a vector of estimated coefficients for the nonlinear regression. The coefficients are estimated using iterative least squares estimation, with initial values being provided as inputs to this function. Other inputs needed are the specified model <i>fun</i> , a vector with model responses <i>Y</i> and the predictors matrix <i>X</i> .
rand()	Returns uniformly distributed random numbers in the interval (1,0).
selforgmap()	Returns a self-organizing map structure based on user-defined characteristics such as dimensions, layer topology and neuron distance function. The self-organizing map is then calibrated using train() function to the input matrix <i>X</i> of size ( <i>m</i> x <i>n</i> ), where <i>m</i> is the number of observations and <i>n</i> is the number of independent variables.

## A1.2. Model performance metrics

### R-Squared (R<sup>2</sup>)

The coefficient of determination, also known as R-Squared, R<sup>2</sup> is a commonly used metric for assessing the goodness of fit of a model. R<sup>2</sup> measures the degree of linear relationship between two variables *X* and *Y* as the square of the correlation coefficient. An R-Squared value of 1 indicates a perfect fit with data, whereas a value of 0 indicates no correlation between the two variables.

$$R^2 = \left( \frac{\sum_{i=1}^n (x_i - \bar{x}) \cdot (y_i - \bar{y})}{\sqrt{\sum_{i=1}^n (x_i - \bar{x})^2 \cdot \sum_{i=1}^n (y_i - \bar{y})^2}} \right)^2 \quad (\text{eq A.1})$$

Where  $x_i$  is the  $i$ th observation of variable *X*,  $\bar{x}$  is the mean value of *X*,  $y_i$  is the  $i$ th observation of variable *Y* and  $\bar{y}$  is the mean value of *Y*, and  $n$  is the number of observations in the dataset

### Adjusted R-Squared (Adjusted-R<sup>2</sup>)

The definition of the Adjusted-R<sup>2</sup> builds upon R-Squared, but it is adjusted for the number of terms in a model. Therefore, it corrects the problem of adding too much independent variables for obtaining higher R<sup>2</sup> values, possibly causing overfitting problems.

$$\text{Adjusted } R^2 = 1 - \left[ \frac{(1-R^2) \cdot (n-1)}{n-k-1} \right] \quad (\text{eq A.2})$$

Where  $k$  is the number of independent variables used in the model.

### **Spearman's rank correlation coefficient ( $\rho$ )**

Spearman's rank correlation coefficient ( $\rho$ ) measures the degree of agreement between two variables. In comparison to Pearson's correlation coefficient,  $\rho$  is suitable for both ordinal and continuous variables and can be used for measuring both linear and nonlinear relationships. In this method, the ranks of values are used instead of the values themselves.

The difference between two rank values is defined as:

$$d_i = R(x_i) - R(y_i) \quad (\text{eq A.3})$$

Where  $R(x_i)$  is the rank of the  $i$ th value of variable  $X$ . Following, the Spearman's rank correlation coefficient can be calculated as:

$$\rho = 1 - \frac{6 \cdot \sum_{i=1}^n d_i^2}{n(n^2-1)} \quad (\text{eq A.4})$$

### **Mean Absolute Error (MAE)**

The mean absolute error is calculated as follows:

$$MAE = \frac{\sum_{i=1}^n \text{abs}(y_i - f(x_i))}{n} \quad (\text{eq A.5})$$

Where  $f(x_i)$  is the model evaluated at the  $i$ th observation of  $X$ .



## Annex II

### A2.1. Sensitivity Analysis

#### A2.1.1. Connection Weight (CW) method

CW is an approach for assessing the relative importance of input variables. The overall connection weight ( $OCW_i$ ) is calculated as the sum of the product of input-hidden and hidden-output weight connections for each input variable (eq. A.2). From this, the relative importance of each input  $RI_{CW,i}$  is calculated following eq. A.1 and A.2.

$$OCW_i = \sum_{j=1}^J w_{i,j} \cdot w_{j,o} \quad (\text{eq. A.6})$$

$$RI_{CW,i} = \frac{OCW_i}{\sum_{k=1}^K |OCW_k|} 100 \quad (\text{eq. A.7})$$

where  $w_{i,j}$  is the connection weight between the  $i$ th input variable and  $j$ th hidden node, and  $w_{j,o}$  is the connection weight between the  $j$ th hidden node and the output.

#### A2.1.2. Partial Derivatives Method

PaD method computes, as the name indicates, the partial derivative of the model output with respect to the input variables. The approach for single hidden-layer MLP with sigmoid activation function can be computed with eq. A.3, giving a result for every  $n=1\dots N$  observation on the dataset.

$$\frac{\partial O_n}{\partial I_{i,n}} = O_n(1 - O_n) \cdot \sum_{j=1}^J w_{j,o} h_{j,n} (1 - h_{j,n}) w_{ij} \quad (\text{eq. A.8})$$

where  $O_n$  is the output of the  $n$ th observation,  $I_i$  is the  $i$ th input variable,  $h_j$  is the output of the  $j$ th hidden node. From the partial derivative, the root mean squared derivative ( $RMSD_i$ ) and the relative importance ( $RI_{PaD,i}$ ) can be calculated with eq. A.4 and A.5.

$$RMSD_i = \sqrt{\sum_{n=1}^N \left(\frac{\partial O_n}{\partial I_{i,n}}\right)^2 / N} \quad (\text{eq A.9})$$

$$RI_{PaD,i} = \frac{RMSD_i}{\sum_{k=1}^K RMSD_k} \cdot 100 \quad (\text{eq A.10})$$

### A2.1.3. Profile Method

The Profile Method is a one-at-a-time SA method, in which the variable of interest is evaluated over the range, while keeping the rest of the variables fixed at their minimum, 1<sup>st</sup> quartile, median, 3<sup>d</sup> quartile and maximum values. The median of these outputs is calculated to represent the median output variation. The RI using this method can be calculated as follows:

$$RI_{PM,i} = \frac{\max(\hat{y}_i) - \min(\hat{y}_i)}{\sum_{k=1}^K [\max(\hat{y}_i) - \min(\hat{y}_i)]} \cdot 100 \quad (\text{eq A.11})$$

where  $\hat{y}_i$  is a vector of median output values obtained by varying the  $i$ th input over its range.

## A2.2. Summary statistics of ANN models

**Table A 2.** ANN-1 summary statistics of parameter estimators.

Parameter	Mean	St. Dev.	95% CI
$w_{1,1}$	0,814	0,100	$\pm 0,197$
$w_{2,1}$	1,074	0,157	$\pm 0,308$
$w_{3,1}$	0,548	0,083	$\pm 0,163$
$w_{4,1}$	-0,175	0,054	$\pm 0,107$
$w_1$	2,883	0,184	$\pm 0,361$
$b_1$	1,064	0,129	$\pm 0,252$
$b_2$	-1,898	0,149	$\pm 0,292$

**Table A 3.** ANN-4 summary statistics of parameter estimators.

Parameter	Mean	St. Dev.	95% CI
$w_{1,1}$	1,213	0,518	1,016
$w_{2,1}$	-0,111	0,130	0,255
$w_{3,1}$	0,381	0,334	0,656
$w_{4,1}$	-1,003	0,380	0,745
$w_{1,2}$	-0,005	0,011	0,021
$w_{2,2}$	0,815	0,109	0,214
$w_{3,2}$	0,488	0,086	0,168
$w_{4,2}$	0,080	0,079	0,155
$w_{1,3}$	-1,115	0,267	0,525
$w_{2,3}$	-1,292	0,321	0,630
$w_{3,3}$	0,035	0,060	0,117
$w_{4,3}$	-0,699	0,139	0,273
$w_{1,4}$	-1,421	0,150	0,295
$w_{2,4}$	-0,868	0,172	0,339
$w_{3,4}$	-0,036	0,044	0,087
$w_{4,4}$	0,179	0,131	0,257
$w_1$	-0,980	0,313	0,614
$w_2$	3,118	0,292	0,574

<b>w<sub>3</sub></b>	2,039	0,147	0,288
<b>w<sub>4</sub></b>	-3,721	0,224	0,440
<b>b<sub>1</sub></b>	0,485	0,259	0,509
<b>b<sub>2</sub></b>	1,300	0,155	0,305
<b>b<sub>3</sub></b>	0,290	0,074	0,146
<b>b<sub>4</sub></b>	-0,387	0,051	0,099
<b>b<sub>5</sub></b>	-1,203	0,205	0,401

**Table A 4.** ANN-7 summary statistics of parameter estimators.

<b>Parameter</b>	<b>Mean</b>	<b>St. Dev.</b>	<b>95% CI</b>
<b>w<sub>1,1</sub></b>	-3,620	0,499	0,980
<b>w<sub>2,1</sub></b>	0,487	0,477	0,937
<b>w<sub>3,1</sub></b>	2,408	1,392	2,733
<b>w<sub>4,1</sub></b>	0,471	0,468	0,919
<b>w<sub>1,2</sub></b>	-0,022	0,062	0,122
<b>w<sub>2,2</sub></b>	0,933	0,087	0,171
<b>w<sub>3,2</sub></b>	1,723	0,362	0,711
<b>w<sub>4,2</sub></b>	-1,127	0,250	0,491
<b>w<sub>1,3</sub></b>	0,006	0,026	0,051
<b>w<sub>2,3</sub></b>	-1,427	0,028	0,056
<b>w<sub>3,3</sub></b>	-0,820	0,223	0,437
<b>w<sub>4,3</sub></b>	0,006	0,010	0,020
<b>w<sub>1,4</sub></b>	1,752	0,444	0,871
<b>w<sub>2,4</sub></b>	1,125	0,118	0,232
<b>w<sub>3,4</sub></b>	-0,153	0,388	0,762
<b>w<sub>4,4</sub></b>	-0,904	0,647	1,270
<b>w<sub>1,5</sub></b>	0,658	0,123	0,241
<b>w<sub>2,5</sub></b>	-0,100	0,118	0,231
<b>w<sub>3,5</sub></b>	-1,371	0,333	0,654
<b>w<sub>4,5</sub></b>	1,300	0,227	0,446
<b>w<sub>1,6</sub></b>	0,171	0,380	0,745
<b>w<sub>2,6</sub></b>	-1,341	0,221	0,434
<b>w<sub>3,6</sub></b>	-0,241	0,209	0,410
<b>w<sub>4,6</sub></b>	-0,873	1,280	2,514

<b>w<sub>1,7</sub></b>	-3,344	0,577	1,134
<b>w<sub>2,7</sub></b>	-0,594	0,165	0,325
<b>w<sub>3,7</sub></b>	0,066	0,117	0,230
<b>w<sub>4,7</sub></b>	-0,172	0,264	0,519
<b>w<sub>1</sub></b>	-0,298	0,055	0,107
<b>w<sub>2</sub></b>	1,124	0,003	0,005
<b>w<sub>3</sub></b>	-1,641	0,050	0,098
<b>w<sub>4</sub></b>	0,162	0,001	0,001
<b>w<sub>5</sub></b>	0,548	0,013	0,026
<b>w<sub>6</sub></b>	-0,068	0,038	0,076
<b>w<sub>7</sub></b>	-0,476	0,015	0,028
<b>b<sub>1</sub></b>	0,313	0,566	1,111
<b>b<sub>2</sub></b>	-1,117	0,292	0,573
<b>b<sub>3</sub></b>	-1,881	0,199	0,391
<b>b<sub>4</sub></b>	0,076	0,029	0,058
<b>b<sub>5</sub></b>	0,189	0,107	0,209
<b>b<sub>6</sub></b>	0,138	0,410	0,806
<b>b<sub>7</sub></b>	-1,234	0,237	0,465
<b>b<sub>8</sub></b>	-0,004	0,016	0,031

---



A2.3. Correlation of ANN model parameters

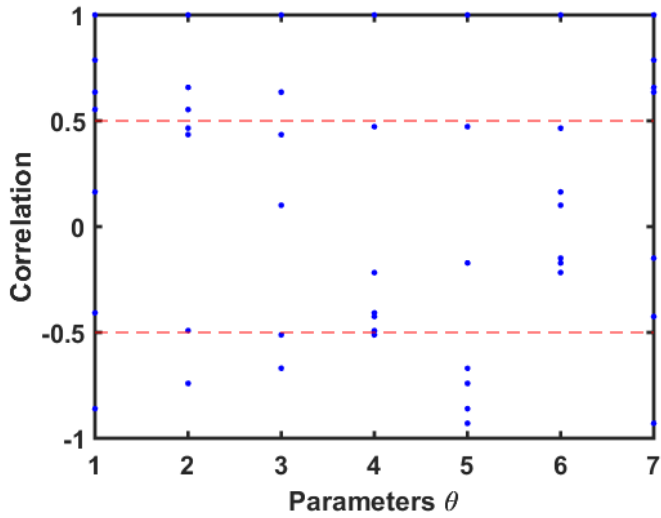

Figure A 1. Representation of ANN-1 model parameters correlation.

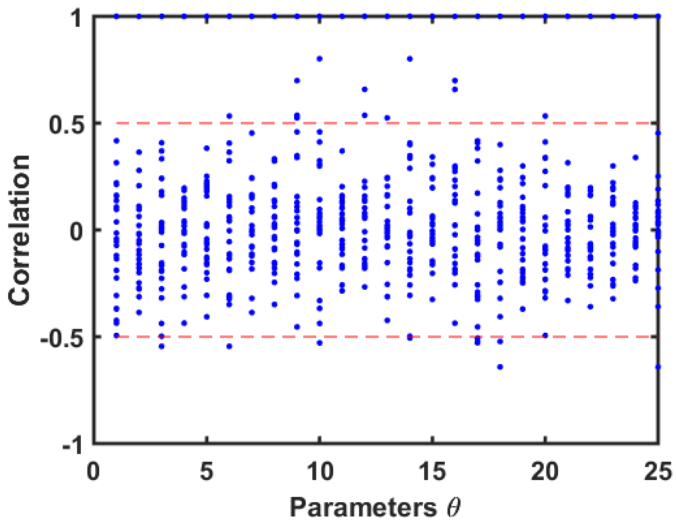
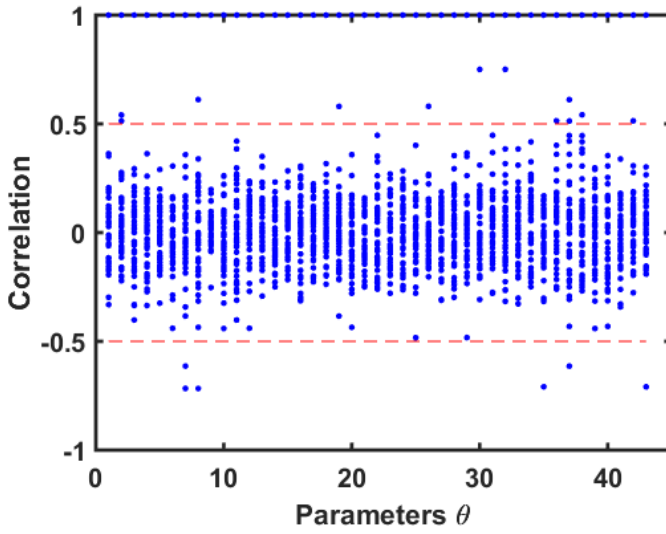
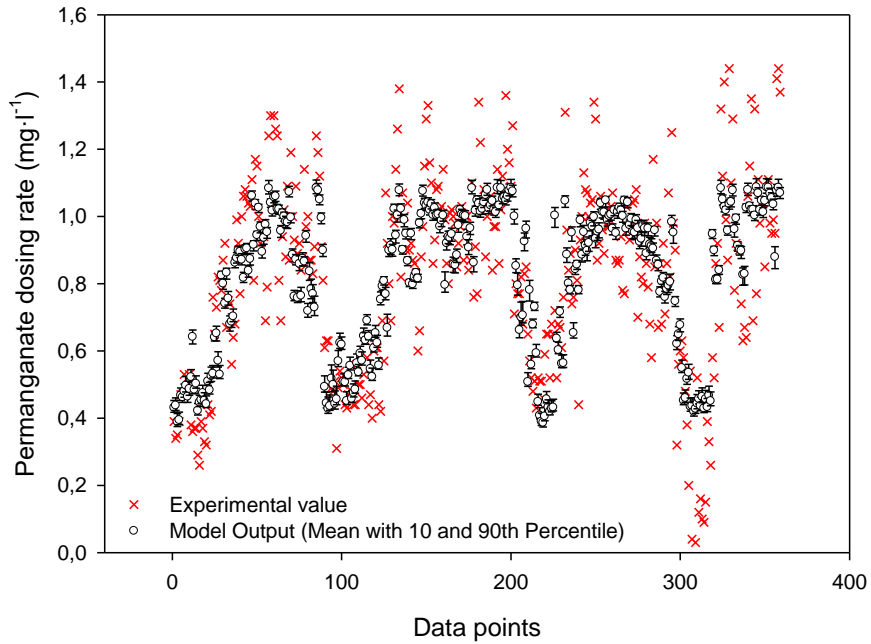

Figure A 2. Representation of ANN-1 model parameters correlation.

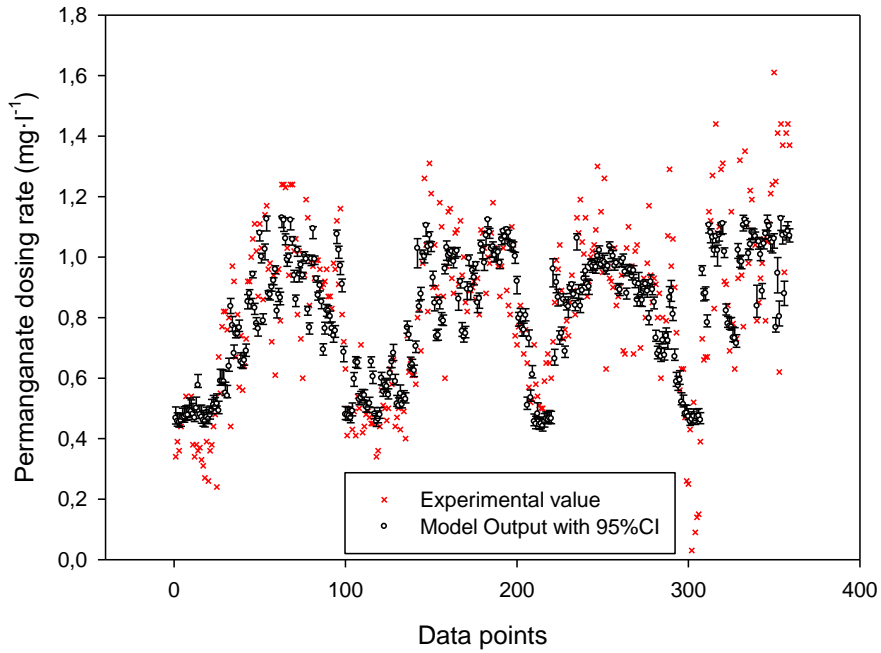

**Figure A 3.** Representation of ANN-1 model parameters correlation.

## A2.4. Representation of uncertainty in ANN predictions



**Figure A 4.** Representation of uncertainty in ANN-1 predictions for  $\text{KMnO}_4$  demand time-series using Monte Carlo method for ANN1, showing the experimental values vs the model output, with 10<sup>th</sup> and 90<sup>th</sup> percentile for the period 1/1/2015-1/9/2018.



**Figure A 5.** Representation of uncertainty in ANN-4 predictions for  $\text{KMnO}_4$  demand time-series using Monte Carlo method for ANN1, showing the experimental values vs the model output, with 10<sup>th</sup> and 90<sup>th</sup> percentile for the period 1/1/2015-1/9/2018.

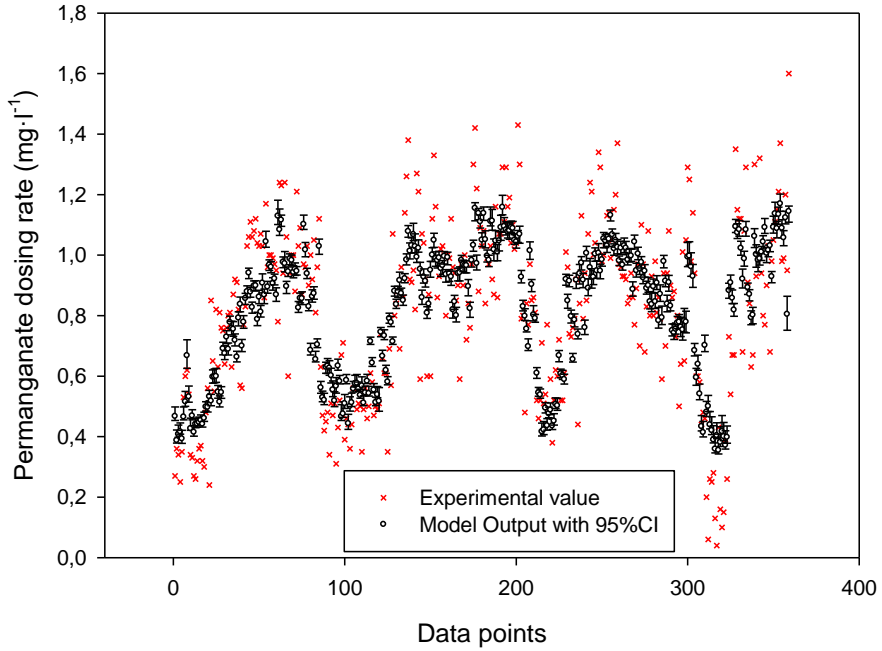

**Figure A 6.** Representation of uncertainty in ANN-7 predictions for  $\text{KMnO}_4$  demand time-series using Monte Carlo method for ANN1, showing the experimental values vs the model output, with 10<sup>th</sup> and 90<sup>th</sup> percentile for the period 1/1/2015-1/9/2018.

## A2.5. Profile method plots

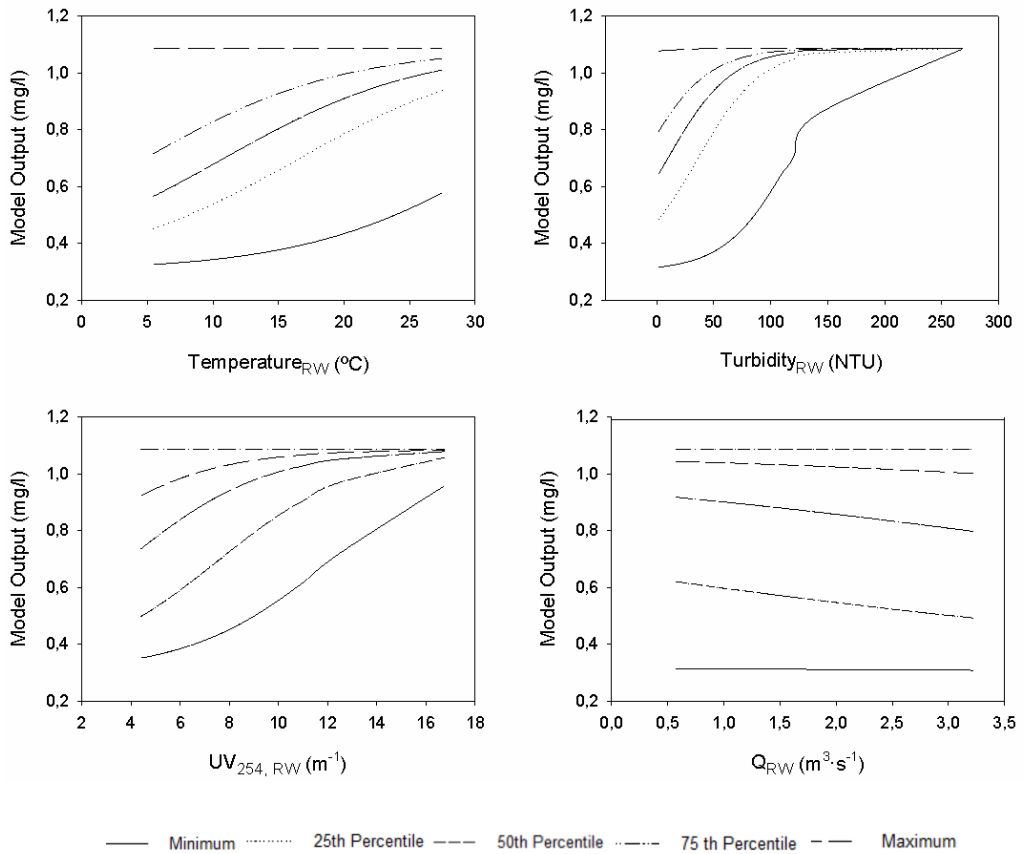
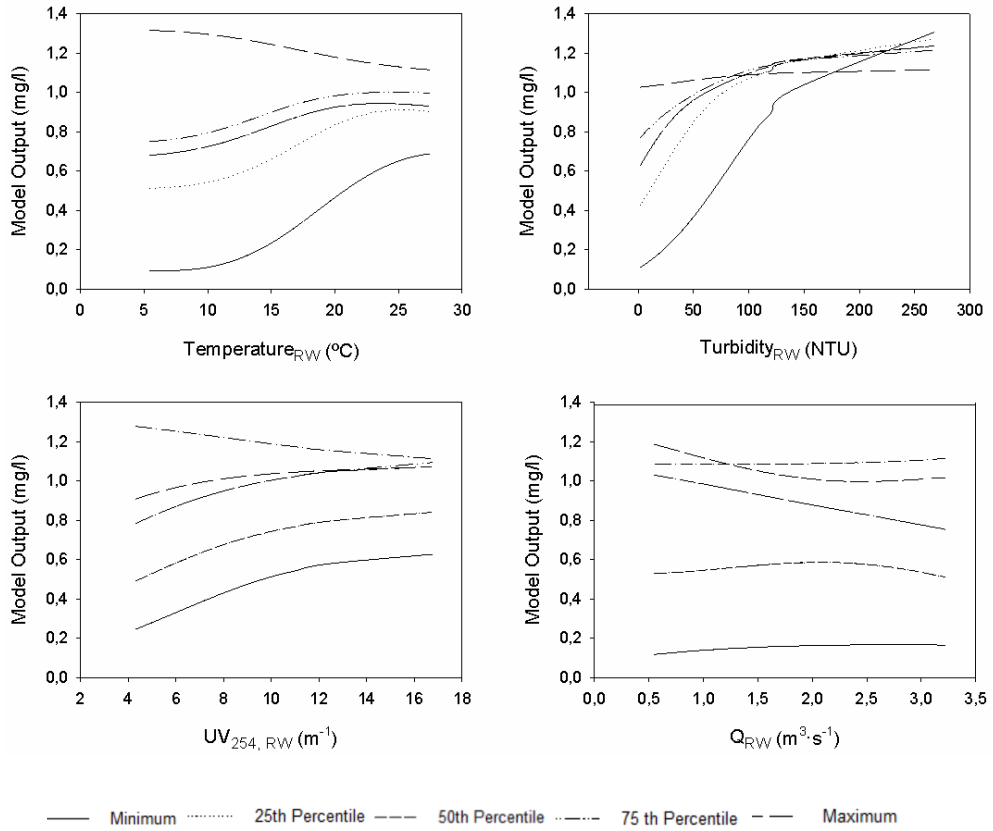
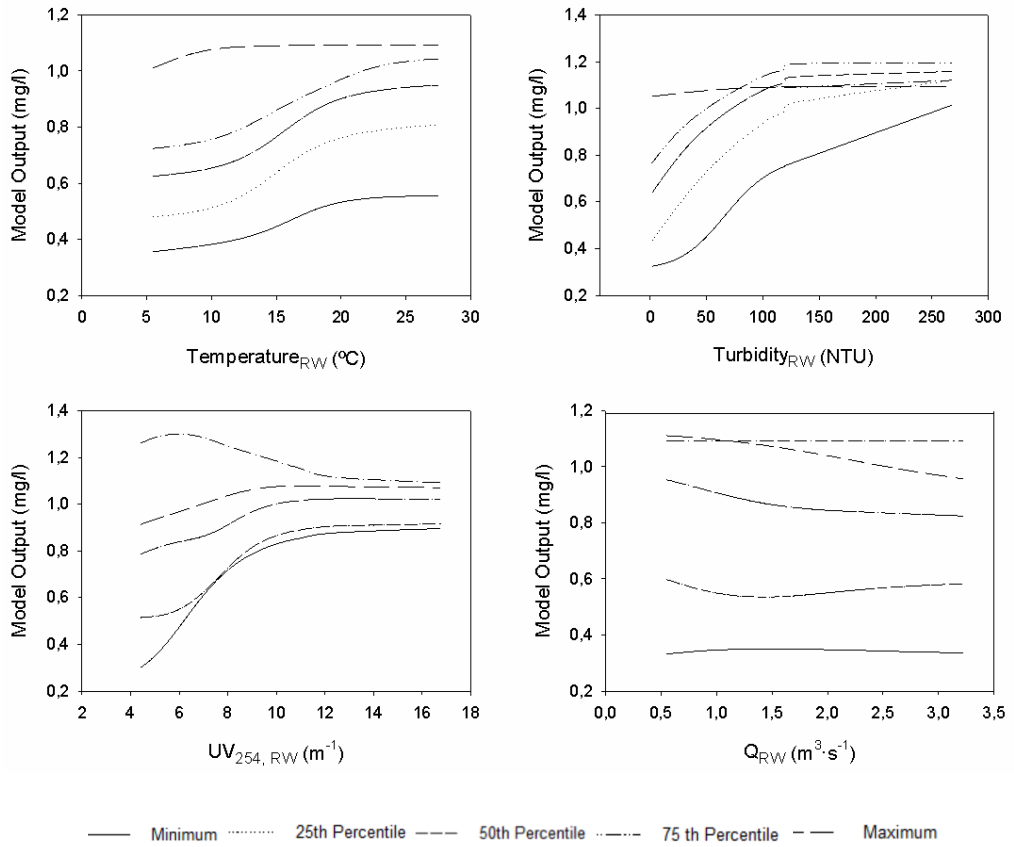

Figure A 7. Profile method plots for ANN-1.



**Figure A 8.** Profile method plots for ANN-4.



**Figure A 9.** Profile method plots for ANN-7.





Annex III

A3.1. Profile method plots

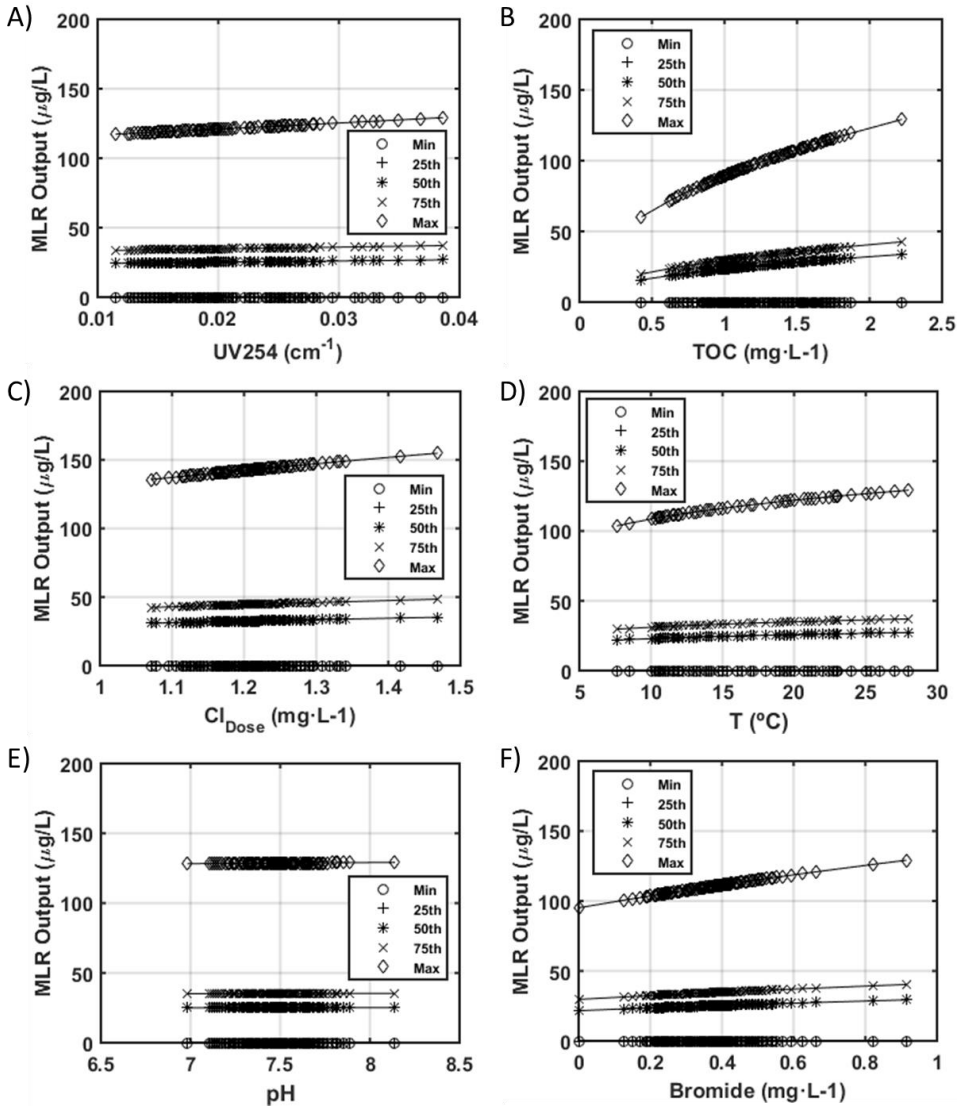
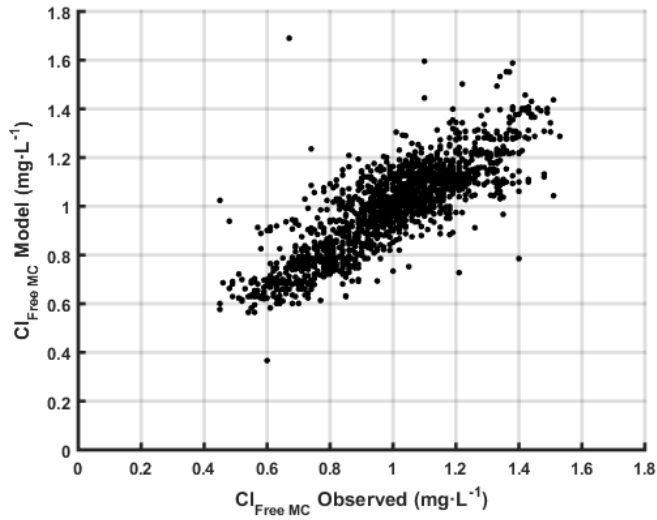

Figure A 10. Profile method plots of MLR considering variations on input variables: A) UV254; B) TOC; C)  $\text{Cl}_{\text{Dose}}$ ; D) Temperature; E) pH; F) Bromide



## Annex IV

## A4.1. Regression results



**Figure A 11.** Predicted versus modelled Cl<sub>Free MC</sub> values from NaOCl and ClO<sub>2</sub> doses.

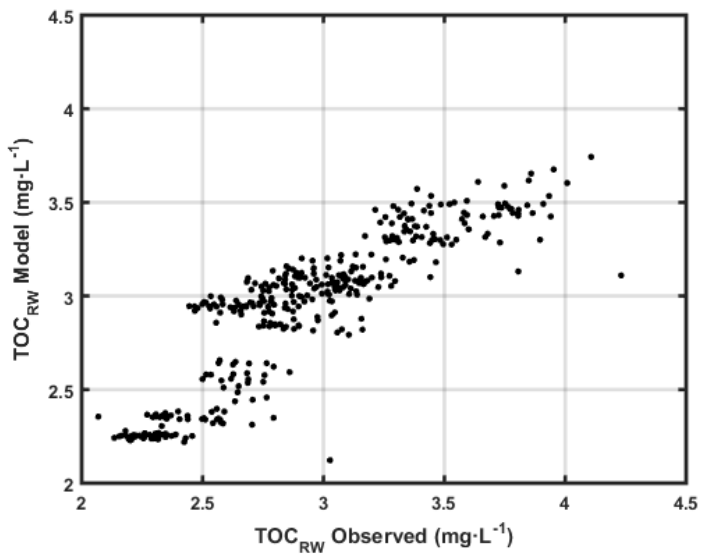

**Figure A 12.** Predicted versus modelled TOC<sub>RW</sub> values from fDOM<sub>RW</sub> and T<sub>RW</sub> values.

A4.2. Operational conditions at Ter DWTP

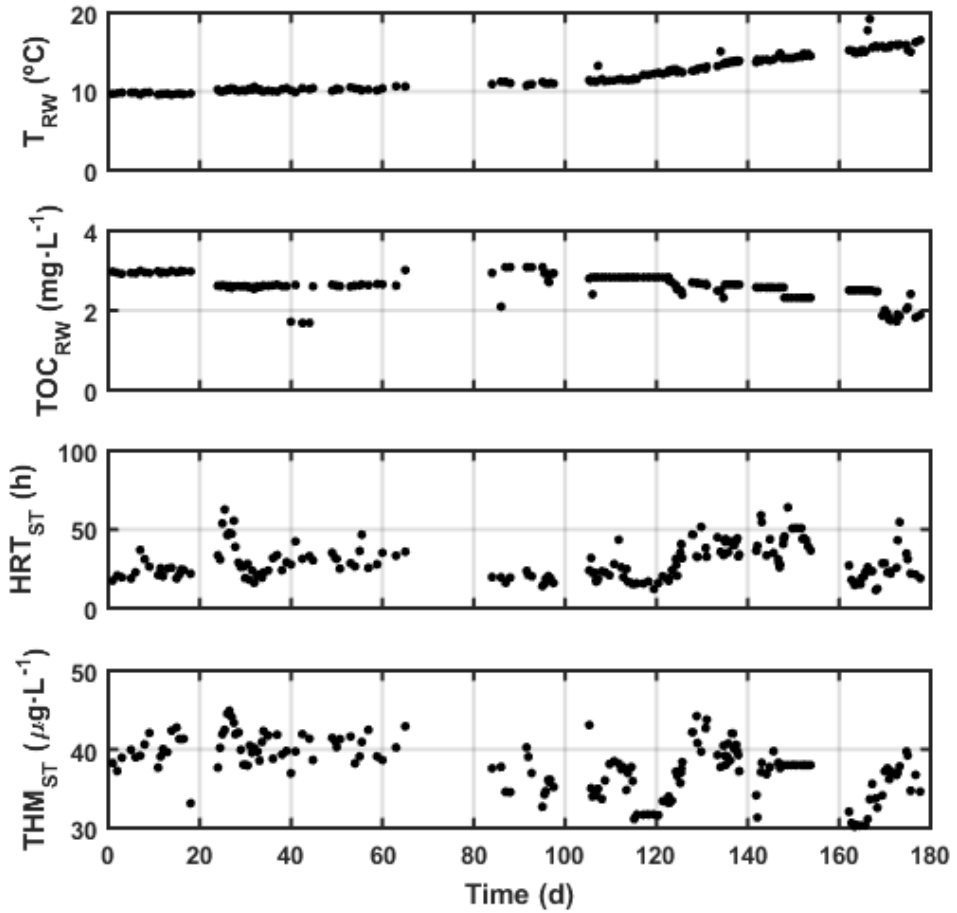
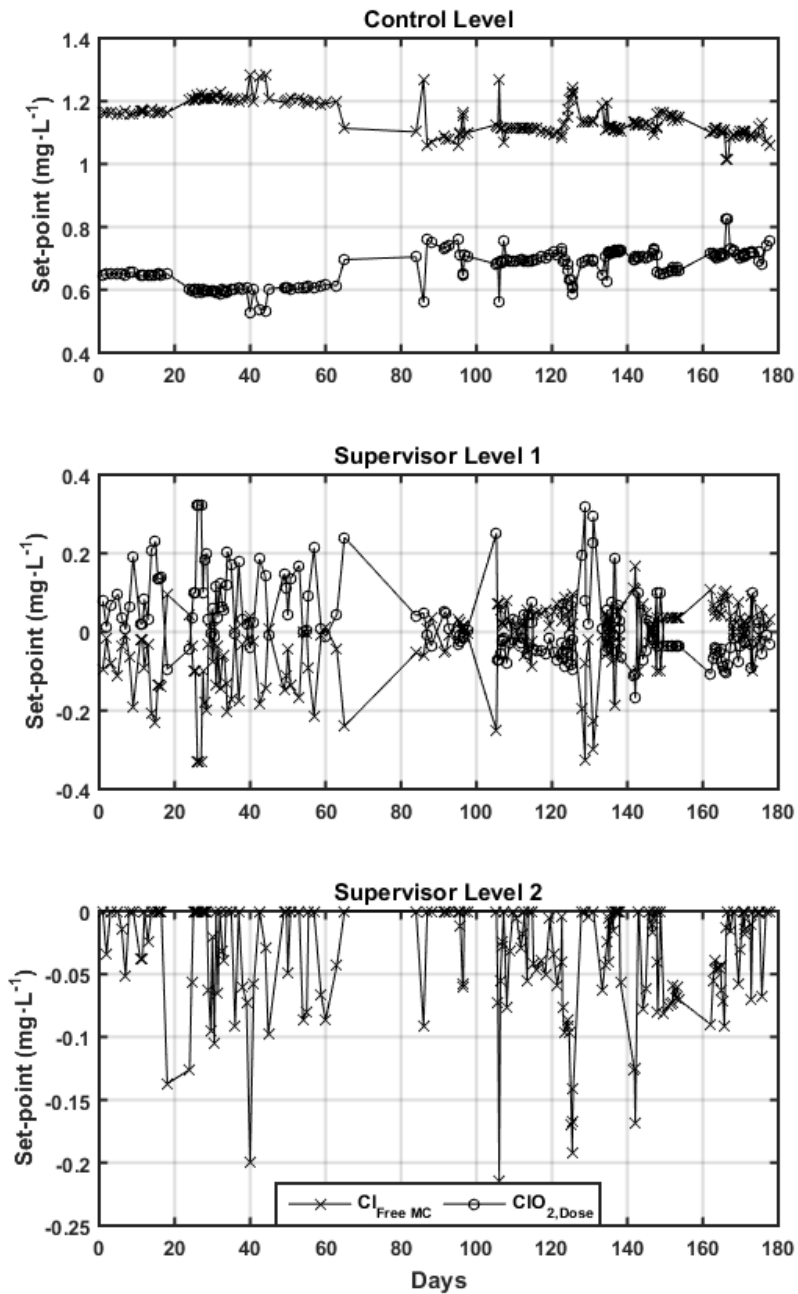

Figure A 13. Input values during implementation of EDSS.

## A4.3. Responses of different EDSS levels



**Figure A 14.** Control level, supervisor level 1 and 2 responses to  $\text{Cl}_{\text{FreeMC}}$  and  $\text{ClO}_{2 \text{ Dose}}$  along the implementation of the EDSS on the full-scale facility