



Universitat Autònoma de Barcelona

ADVERTIMENT. L'accés als continguts d'aquesta tesi doctoral i la seva utilització ha de respectar els drets de la persona autora. Pot ser utilitzada per a consulta o estudi personal, així com en activitats o materials d'investigació i docència en els termes establerts a l'art. 32 del Text Refós de la Llei de Propietat Intel·lectual (RDL 1/1996). Per altres utilitzacions es requereix l'autorització prèvia i expressa de la persona autora. En qualsevol cas, en la utilització dels seus continguts caldrà indicar de forma clara el nom i cognoms de la persona autora i el títol de la tesi doctoral. No s'autoritza la seva reproducció o altres formes d'explotació efectuades amb finalitats de lucre ni la seva comunicació pública des d'un lloc aliè al servei TDX. Tampoc s'autoritza la presentació del seu contingut en una finestra o marc aliè a TDX (framing). Aquesta reserva de drets afecta tant als continguts de la tesi com als seus resums i índexs.

ADVERTENCIA. El acceso a los contenidos de esta tesis doctoral y su utilización debe respetar los derechos de la persona autora. Puede ser utilizada para consulta o estudio personal, así como en actividades o materiales de investigación y docencia en los términos establecidos en el art. 32 del Texto Refundido de la Ley de Propiedad Intelectual (RDL 1/1996). Para otros usos se requiere la autorización previa y expresa de la persona autora. En cualquier caso, en la utilización de sus contenidos se deberá indicar de forma clara el nombre y apellidos de la persona autora y el título de la tesis doctoral. No se autoriza su reproducción u otras formas de explotación efectuadas con fines lucrativos ni su comunicación pública desde un sitio ajeno al servicio TDR. Tampoco se autoriza la presentación de su contenido en una ventana o marco ajeno a TDR (framing). Esta reserva de derechos afecta tanto al contenido de la tesis como a sus resúmenes e índices.

WARNING. The access to the contents of this doctoral thesis and its use must respect the rights of the author. It can be used for reference or private study, as well as research and learning activities or materials in the terms established by the 32nd article of the Spanish Consolidated Copyright Act (RDL 1/1996). Express and previous authorization of the author is required for any other uses. In any case, when using its content, full name of the author and title of the thesis must be clearly indicated. Reproduction or other forms of for profit use or public communication from outside TDX service is not allowed. Presentation of its content in a window or frame external to TDX (framing) is not authorized either. These rights affect both the content of the thesis and its abstracts and indexes.

Alma Mater Studiorum – Università di Bologna
In collaborazione con LAST-JD consortium:
Università degli studi di Torino
Universitat Autònoma de Barcelona
Mykolas Romeris University
Tilburg University

DOTTORATO DI RICERCA IN

**Erasmus Mundus Joint International Doctoral Degree in Law,
Science and Technology**

Ciclo 29 – A.Y. 2013/2014

Settore Concorsuale di afferenza: 12H3

Settore Scientifico disciplinare: IUS20

TITOLO TESI

**Towards a Legal and Ethical Framework for Personal Care Robots.
Analysis of Person Carrier, Physical Assistant and Mobile Servant Robots**

Presentata da: EDUARD FOSCH VILLARONGA

Coordinatore

Prof. Monica Palmirani

Co- Relatore

Relatore

Antoni Roig Batalla

Jordi Albó Canals

Esame finale anno 2017

Alma Mater Studiorum – Università di Bologna
in partnership with LAST-JD Consortium
Università degli studi di Torino
Universitat Autònoma de Barcelona
Mykolas Romeris University
Tilburg University

PhD Programme in
Erasmus Mundus Joint International Doctoral Degree in Law,
Science and Technology
Cycle 29 – a.y. 2013/14

Settore Concorsuale di afferenza: 12H3

Settore Scientifico disciplinare: IUS20

Towards a Legal and Ethical Framework for Personal Care Robots.
Analysis of Person Carrier, Physical Assistant and Mobile Servant Robots

Submitted by: EDUARD FOSCH VILLARONGA

The PhD Programme Coordinator
Prof. Monica Palmirani
Prof. Jordi Albó Canals

Supervisor (s)
Prof. Antoni Roig Batalla

Year 2017



**Universitat Autònoma
de Barcelona**

Departament de Ciència Política i Dret Públic

**TOWARDS A LEGAL AND ETHICAL FRAMEWORK FOR
PERSONAL CARE ROBOTS.**

**ANALYSIS OF PERSON CARRIER, PHYSICAL ASSISTANT
AND MOBILE SERVANT ROBOTS**

Dipositat a la Universitat Autònoma de Barcelona com a
requeriment per al grau de Doctor en Dret, Ciència i Tecnologia del
PhD Programme in
Erasmus Mundus Joint International Doctoral Degree in Law, Science
and Technology
Cycle 29 – a.y. 2013/14

Institut de Dret i Tecnologia (IDT), Àrea de Filosofia i Teoria del Dret

per

Eduard Fosch Villaronga
Bellaterra, Juny 2017

Director:

Dr. Antoni Roig Batalla

Co-Director:

Dr. Jordi Albó Canals

Certifico que he llegit aquesta tesi, que és adequada i compleix tots els requeriments de qualitat per obtenir el grau de Doctor en Dret, Ciència i Tecnologia.

Bellaterra, Juny 2017

Dr. Antoni Roig Batalla
Director de la tesi

Dr. Jordi Albó Canals
Co-Director de la tesi

Eduard Fosch Villaronga
Doctorand

Tribunal:

Dr. Lina Sors Emilsson
Dr. Christopher Millard
Dr. Aleksandar Rodić

To my mother, the strongest person I've ever known

Abstract. Roboticists building robots that interact with humans may be clueless about what regulations apply to their product. They might not even know whether they are legally responsible for their products. Sometimes, even law is not prepared to promptly accommodate new types of technology, e.g. driverless cars. Therefore, when a new robot is created or a new function/use is introduced, an assessment of the impacts should be carried out.

This assessment should be made first against regulations to make sure that this new technology or its new use remains within the existing liberty space. If the creators of the robot do not encounter any limitations, they can then proceed with its development. On the contrary, if there are some limitations, robot creators will either (1) adjust the robot to comply with the existing regulatory framework; (2) start a negotiation with the regulators to change the law, so that the original robot is compliant with a new regulation; or (3) carry out the original plan and risk to be non-compliant.

The regulator can discuss existing (or lacking) regulations with robot developers and give a legal response accordingly. In an ideal world, robots are clear of impacts and therefore threats can be responded in terms of prevention and opportunities in form of facilitation. In reality, the impacts of robots are often uncertain and less clear, especially when they are inserted in care applications. Therefore, regulators will have to address uncertain risks, ambiguous impacts and yet unknown effects.

Technology is rapidly developing, and regulators and robot creators inevitably have to come to terms with new and unexpected scenarios. A thorough analysis of this new and continuously evolving reality could be useful to better understand the current situation and pave the way to the future creation of a legal and ethical framework that takes into proper account all these new technologies. This is clearly a wide and complex goal, considering the variety of new technologies available today and those under development. Therefore, this thesis focuses on the evaluation of the impacts of personal care robots. In particular, it analyzes how roboticists adjust their creations to the existing regulatory framework for legal compliance purposes.

By carrying out the impact assessment analysis, existing regulatory gaps and lack of regulatory clarity can be highlighted. These gaps should of course be considered further on by lawmakers for a future legal framework for personal care robot.

Contents

CONTENTS	9
LIST OF ACRONYMS	12
LIST OF FIGURES	13
LIST OF TABLES	14
ACKNOWLEDGEMENTS	16
INTRODUCTION	21
1. ROBOT TECHNOLOGY IN HEALTHCARE	21
2. RECENT DEVELOPMENTS ON HEALTHCARE SERVICE ROBOTICS: PERSONAL CARE ROBOTS	23
3. RESEARCH QUESTIONS	26
4. METHODOLOGY	27
5. STRUCTURE OF THE THESIS	32
6. READING PATHS	32
6.1. <i>For personal care robot creators</i>	32
6.2. <i>For legal scholars</i>	33
6.3. <i>For law and policymakers</i>	33
1. CHAPTER - PERSONAL CARE ROBOTS: DESCRIPTION AND REGULATORY NEEDS	34
1. DEFINITION OF ROBOT	34
2. PERSONAL CARE ROBOT AS SERVICE ROBOT	40
3. TYPES OF PERSONAL CARE ROBOT	42
3.1 <i>Person Carrier Robot</i>	43
3.2 <i>Physical Assistant Robot</i>	47
3.3 <i>Mobile Servant Robot</i>	52
4. ARE PERSONAL CARE ROBOTS SOCIAL OR NON SOCIAL ROBOTS?	55
5. ROBOTS EXCLUDED BY ISO 13482:2014	61
5.1. <i>Robots travelling faster than 20 km/h</i>	62
5.2. <i>Robot toys</i>	62
5.3. <i>Water-borne robots and flying robots</i>	64
5.4. <i>Industrial robots</i>	65
5.5. <i>Robots as medical devices</i>	66
5.6. <i>Military or public force application robots</i>	67
2. CHAPTER - PERSONAL CARE ROBOTS LEGAL FRAMEWORK: BEYOND CURRENT STATE OF THE ART	69
1. INDUSTRIAL STANDARDS AS A FRAME FOR PERSONAL CARE ROBOTS	69
2. EVOLUTION OF THE LEGAL DISCUSSION ON ROBOTS	71
3. CURRENT LEGAL AND ETHICAL FRAMEWORK FOR PERSONAL CARE ROBOTS	73
a. <i>Safety</i>	74
b. <i>Consumer Robotics</i>	75
c. <i>Liability</i>	76
d. <i>User Rights</i>	81
e. <i>Autonomy</i>	84
f. <i>Dignity</i>	84
g. <i>Ethics</i>	84

<i>h. Justice</i>	85
4. PROBLEMS ASSOCIATED WITH THE CURRENT LEGAL AND ETHICAL FRAMEWORK FOR PERSONAL CARE ROBOTS	86
5. RISK MANAGEMENT METHODOLOGY APPLIED TO LEGAL MATTERS	88
6. RISK MANAGEMENT METHODOLOGY APPLIED TO PERSONAL CARE ROBOTS	90
5.1. <i>First step: Explain the Context</i>	93
5.2. <i>Second Step: Describe the Robot Type and Characteristics</i>	95
5.3. <i>Third Step: Identify Risk Scenarios</i>	95
5.4. <i>Fourth Step: Mitigate the Identified Risks</i>	96
3. CHAPTER - ANALYSIS OF NON-SOCIAL PERSONAL CARE ROBOTS	98
PART A: PERSON CARRIERS	98
1. PERSON CARRIERS ROBOTS: WHEELED PASSENGER CARRIERS	98
2. CONTEXT	100
3. ROBOT TYPE: WHEELED PASSENGER CARRIER	105
3.1. <i>Description of the Robotic System and Applications</i>	106
3.2. <i>Characteristics of the robotic system</i>	107
4. RISK SCENARIOS	110
4.1. <i>Safety</i>	110
4.2. <i>Consumer Robotics</i>	115
4.3. <i>Liability</i>	119
4.4. <i>User Rights Safeguard</i>	123
4.5. <i>Autonomy</i>	126
4.6. <i>Dignity</i>	127
4.7. <i>Ethics</i>	131
4.8. <i>Justice</i>	132
5. SUMMARY OF PERSON CARRIER ROBOTS ANALYSIS	134
PART B: PHYSICAL ASSISTANTS	142
1. PHYSICAL ASSISTANT ROBOTS: LOWER-LIMB EXOSKELETONS	142
2. CONTEXT	146
3. ROBOT TYPE: LOWER BODY MOBILITY EXOSKELETON “EXO KOOL”	149
3.1. <i>Description of the Robotic system and applications</i>	150
3.2. <i>Characteristics of the Robotic system and applications</i>	152
4. RISK SCENARIOS	159
4.1. <i>Safety</i>	159
4.2. <i>Consumer robotics</i>	166
4.3. <i>Liability</i>	167
4.4. <i>User Rights Safeguard</i>	171
4.5. <i>Autonomy</i>	174
4.6. <i>Dignity</i>	177
4.7. <i>Ethics</i>	178
4.8. <i>Justice</i>	180
5. SUMMARY OF PHYSICAL ASSISTANT ROBOTS ANALYSIS	181
4. CHAPTER - ANALYSIS OF SOCIAL PERSONAL CARE ROBOTS: MOBILE SERVANTS	192
1. MOBILE SERVANT ROBOTS: SOCIALLY ASSISTIVE ROBOTS	192
2. CONTEXT	196
3. ROBOT TYPE: SOCIALLY ASSISTIVE ROBOT	200
3.1. <i>Description of the Robotic system and applications</i>	201
3.2. <i>Characteristics of the Robotic system and applications</i>	202

4.	RISK SCENARIOS	206
5.1.	<i>Safety</i>	206
5.2.	<i>Consumer robotics</i>	219
5.3.	<i>Liability</i>	224
5.4.	<i>User rights</i>	230
5.5.	<i>Autonomy</i>	241
5.6.	<i>Dignity</i>	249
5.7.	<i>Ethics</i>	252
5.8.	<i>Justice</i>	257
6.	SUMMARY OF MOBILE SERVANT ROBOTS ANALYSIS	257
5. CHAPTER - CONSIDERATIONS FOR LAWMAKERS: AREAS OF INTEREST OR CONCERN AND POSSIBLE ISSUES AND CHALLENGES		270
1.	GENERAL CONSIDERATIONS	270
2.	GENERAL ISSUES AND CHALLENGES FOR PERSONAL CARE ROBOTS	274
3.	ISSUES AND CHALLENGES FOR PERSON CARRIER ROBOTS	286
4.	ISSUES AND CHALLENGES FOR PHYSICAL ASSISTANTS ROBOTS.....	291
5.	ISSUES AND CHALLENGES FOR MOBILE SERVANT ROBOTS	297
CONCLUSIONS.....		303
1.	ACHIEVED GOALS CONCERNING THE METHODOLOGY	303
2.	GENERAL CONSIDERATIONS AFTER CRIA APPLICATION.....	305
3.	SPECIFIC CONSIDERATIONS AFTER CRIA APPLICATION	310
4.	FUTURE WORK	313
BIBLIOGRAPHY.....		318
1.	LITERATURE REVIEW	318
2.	NON-ACADEMIC PAPERS	334
3.	REPORTS, RESOLUTIONS, PROJECTS AND STUDIES.....	339
4.	WEBSITE MATERIALS	341

List of Acronyms

AAL	Ambient Assisted Living
BS	British Standard
CEDAW	Convention on the Elimination of All Forms of Discrimination Against Women
CERD	Convention on the Elimination of all Forms of Racial Discrimination
CHRI	Cognitive Human Robot Interaction
CRI	Child-Robot Interaction
CRIA	Care Robot Impact Assessment
CRPD	Convention on the Rights of the Persons with Disabilities
CPSC	Consumer Protection and Safety Commission of the United States
ECHR	European Convention of Human Rights
EU	European Union
EU CFR	European Charter of Fundamental Rights
FDA	Food and Drug Administration of the United States
FTC	Federal Trade Commission of the United States
GDPR	General Data Protection Regulation
HRI	Human-Robot Interaction
HUCA	Hospital Universitario Central de Asturias
IA	Impact Assessment
ICESCR	International Covenant on Economic, Social and Cultural Rights
ISO	International Standard Organization
MSR	Mobile Servant Robot
PAR	Physical Assistant Robot
PCR	Personal Care Robot
PCaR	Person Carrier Robot
RR	Regulatory Robot
SIA	Surveillance Impact Assessment
STOA	Science and Technology Opinion Assessment, EU Parliament
UAS	Unmanned Aircraft System
UDHR	Universal Declaration of Human Rights
US	United States of America

List of Figures

Figure 1 Robolaw project’s survey. Source Deliver 6.2. Guidelines on the Regulation of Robotic Technology.....	22
Figure 2 Hierarchical Structure of International Standards (ISO/IEC)	25
Figure 3 Robots that should be banned. Extracted from eurobarometer 2012.....	29
Figure 4 Shift from Industrial Robotics to Service Robotics. Main features.	40
Figure 9 RIBA Source: tecnocactualblog.wordpress.com/2012/02/21/el-robot-ayudante/	47
Figure 12 Personal Care Robot Classification.....	56
Figure 13 Potential Key Elements for Social Transition	58
Figure 14 Understanding social robots. Hegel et al. op. cit.	60
Figure 16 Quadrants of Regulation from B. W. Smith (2016)	70
Figure 17 Machine Learning (1) and the Responsibility Gap.....	78
Figure 18 Extracted from the A typology of Privacy work from Koops et al.	82
Figure 19 Robot impact assessment for personal care robots	92
Figure 20 From left to right, Panasonic Assist Suit, HULC (Berkeley Robotics) and HAL (Cyberdine)	94
Figure 21 Wheeled Passenger Carrier. Extracted from ISO 13482:2014.	98
Figure 22 Autonomous Grounded Vehicles in the Hospital Central de Asturias. Own photography.	101
Figure 23 Exclusive Robot Corridor (1) and Robot Elevator (2) where you can read in Spanish “Robots exclusive use”. Own photography.	102
Figure 25 Envisioning i-Resyone. Sketch Vite-fait from Helena Heras.....	106
Figure 26 States and Transitions of i-Resyone	114
Figure 27 Masdar City Carriers. Source: techgenmag.com/2015/07/step-inside-masdar-city/	120
Figure 28 Effect of the employment of robot technology. Picture taken in Hospital Universitario Central de Asturias, Spain.	129
Figure 29 IBM Watson IoT 3D Printed bus. Source: Engadget	130
Figure 30 Robot Ranger from EPFL, source: chili.epfl.ch/page-105174-en.html ...	132
Figure 31 Exoskeleton Wearable Robot as showed in ISO 13482:2014.	143
Figure 32 Different Exoskeletons: HULC, Panasonic and Exo-Legs.....	145
Figure 33 Envisioning Robogym. Sketch Vite-fait from Helena Heras.	147
Figure 34 From left to right: Exo-Legs, HiBSO and ExoLite.	150
Figure 35 ExoKool design. <i>Vite-fait</i> own sketch.	151
Figure 36 Extracted from Jeremy Olivier’s work on gait pattern identification, op. cit.	155
Figure 37 Generalized control framework for active lower limb prostheses and orthosis. Tucker et al. op. cit.	156
Figure 38 Baud’s simplified example of hardware architecture that includes sensors and communication environment	157
Figure 39 Control box of HiBSO, Baud, op. cit.	158
Figure 40 Mobile Servant Robot as shown in ISO 13482:2014, Annex D.	193
Figure 42 Cueing Kitchen at Herl. Own Picture.	198
Figure 43 Extracted from A. Rodić et al. op. cit.	200
Figure 44 Institute Mihajlo Pupin’s Robot from Belgrade, Serbia.	200
Figure 45 Three-level of the Robotic System. Extracted from A. Rodić et al. op. cit.	203

Figure 46 Components of the robot (1) and (2). Rodić et al. op. cit.	205
Figure 47 Mobile servant robot size and avoidance of the “poor visibility” hazard	208
Figure 48 Obligation to respond (1): Robot shall not respond (2): Robot shall respond	216
Figure 49 Obligation to respond (3): Utterances from the user.	216
Figure 50 Diagram on Reject Option, extracted from Briggs, G., and Scheutz, M.	219
Figure 51 Robotic System data collection system and and Cloud interaction	232
Figure 52 Picture taken from our iPad. Apple asks for data for their own purposes.	234
Figure 53 Emotion Based Model in Mihaljo Pupin Robot.	239
Figure 54 Displayed message by Apple after some days of using iPhone.....	243
Figure 55 Search results of the BBC search engine for “care workers and home carers”	250
Figure 56 Human-Robot Interaction evolution via adoption of in Mobile Servant Robots	254
Figure 57 Embedded personality to the Robot of Mihaljo Pupin Institute	255
Figure 58 Example of Aspects to Be Taken into Account in a Robotic Policy	273
Figure 59 Number of States within the U.S. that have enacted legislation concerning autonomous cars.....	304
Figure 60 Technological and regulatory development adequacy	313
Figure 61 Wheelchair with Robotic Arm from the Human Engineering Research Laboratory (HERL) Center at the University of Pittsburgh	314
Figure 62 Screenshot of the Regulatory Robot of the Consumer Product Safety Commission	315

List of Tables

Table 1 <i>See</i> D.2. of ISO 13482:2014 plus examples of Physical Assistant Robots ...	50
Table 2 EPSRC Five principles for designers, builders and the users of robots	72
Table 3 Principles involved in the regulation of robotics	74
Table 4 Nursing Home Queen Charlotte Context.....	105
Table 5 Possible list of engineering controls for wheeled passenger carriers (sub-type person carriers).....	141
Table 6 Summary of the different facilities, users and courses at RoboGym.	148
Table 7 Lower-Limb exoskeleton comparison based on their mobility functionalities, characteristics and capabilities	153
Table 8 Extracted from the Exo-Legs Project: Mobility Functionalities for Basic, Standard and Deluxe exoskeletons.....	159
Table 9 Possible list of engineering controls for lower-limb exoskeletons (sub-type physical assistant robots)	191
Table 10 On the left, ten central capabilities of Nussbaum; On the right, ten central robot capabilities	245
Table 11 Chart made by E. Fosch Villaronga based on M. Laukyte’s work on the Nussbaum’s capabilities approach for robots.....	245
Table 12 List of possible controls for socially assistive robots (mobile servant robots sub-type)	269

Acknowledgements

I remember the day when I received the acceptance email from the LAST-JD consortium. It was May 2013. At that time I was working as a junior consultant in Auren Barcelona a consulting firm, one street away from “La Pedrera”, one of Antoni Gaudi’s most important masterpieces. I was in my office, and Prof. Monica Palmirani wrote me an email confirming that EACEA had accepted the list of Ph.D. candidates. I remember going outside the balcony, and calling my mom to give her the news. I was so excited that I could not talk properly, and my mom thought something bad was happening to me. Obviously not, I think it was one of the happiest days in my life. Shouting like crazy, then crying. I simply could not believe that was happening. Since that day, I am very thankful to the entire LAST-JD Consortium for the opportunity I was given, for believing in me and for letting me be part of the Joint International Doctorate Degree in “Law, Science and Technology”.

For my farewell party, my co-workers gave me a black-and-white picture of “La Pedrera”. They knew how much I love Barcelona, and Catalunya. I was moved to tears. I will always remember that moment. Thanks to Anna Sánchez, Tiziana Ingrande, Montse López, and to all Auren Barcelona. Then is when I realized that it was the beginning of a journey, the most international journey I would ever have. What I did not know at that time is that this would not only be an academic journey, but a life journey. These acknowledgements explain a bit this journey and the people who helped me along my way.

Everything started in the University of Bologna. Bologna represents the beauty of Italia. There is where I learned Italian. Bologna has a special warm light at night. I call it home. Bologna has been the base of our program, and we have returned there every six months. Prof. Monica Palmirani has been the head and coordinator of the program, a strong not-always understood woman that has been there always for me. I will always remember Dina Ferrari and Tazia Bianchi who have always helped with all the non-that-exciting administrative tasks. Also the professors we had: Nino Rotolo, Corrado Roversi, Erica Calardo, and Giovanni Sartor In Bologna I also met Prof. Alberto Artosi. Alberto is one of those professors that love his job and is always there. Alberto cares. I always went back to him for intellectual guidance and comfort, and, over the years, we became friends. Thank you Alberto for your support and your encouragement.

Next destination was the University of Torino. I think I could describe that mobility using the words: spring, bicycle and French touch. Thanks to Prof. Guido Boella who was in charge of the courses and our stage in Torino. In that city is where I met Giorgio Schirripa, one of the persons that helped me the most in this thesis. After some time of being friends, I got to know that Giorgio was an English proofreader. He offered me his help countless times, for conference papers, book chapters... and well, finally for this thesis. The good thing about Giorgio is that he is Italian, so he totally understands what another Latin-language speaker tries to say. I do not know what could I have done without him. Thank you Giorgio because you tireless helped me when I needed the most.

That summer I went to the Medical and Service Robots (MESROB) workshop and summer school. The school was in EPFL, Lausanne, and there I met Prof. Mohamed Bouri and Prof. Lina Sors Emilsson. It was the first time a lawyer (me) and a neuroscientist (Lina) were in that workshop. Mohamed and Lina have both supported immensely my work. Mohamed co-organized a workshop with me in Newfriends 2015, the 1st International Conference of Social Robots in Therapy and Education in

Almere, The Netherlands, in October 2015; and then he invited me for a short Ph.D. visit at EPFL in February 2016 where I could see his amazing work on exoskeletons. I will always be thankful for his kindness and openness (and also to the people from his lab especially Amalric, Elahe, Romain and Jeremy). The majority of my exoskeleton images are from Mohamed. Lina came as a keynote speaker of that workshop in Almere, and invited me as a guest lecturer at the course Health Innovation – An Interdisciplinary Approach at the European Institute of Innovation and Technology (EIT) Health Education at Uppsala University, Stockholm, Sweden, in February 2016 and in April 2017. Thank you Lina, for your support, your kindness and your friendship.

After Switzerland I went to Asturias in Spain to visit Adele Robots. I want to thank Celestino Álvarez, Jokín Martín, and Lucía Fernández who not only welcomed my stay, they prepared me countless meetings, among them, with the Hospital Universitario Central de Asturias (HUCA) (that were implementing automated-ground vehicles), with Ana Belén de Juan (worker in a nursing home with the robot seal PARO) and with Ignacio Secades (the founder of Fisiobot, a physiotherapeutic robot company). Some of the pictures I have in my thesis are from this trip.

After that trip, and before moving to Lithuania, I received a terrible blow: my mother was diagnosed with cancer. My mother, María Rosa Villaronga Lorente, the most important person in my life, the strongest pillar I ever had, had breast cancer. I did not know what to do at that moment, and many thoughts crossed my mind, including leaving the program. In October she got operated, and fortunately she did not have metastasis. I moved to Lithuania, to Mykolas Romeris University. Mom recovered positively, and came visit the cold but white and bright Lithuania. She always has visited, and she always has been there for me, even if she has been ill. Prof. Mindaugas Kiškis and Prof. Tadas Limba were very supportive at all time, also Prof. Monica Palmirani. There in Lithuania I also met Prof. Violeta Janulevičienė who showed me the beauty of her country, including Lithuanian language. She, Violeta, total outsider of the program has always been very supportive with my work and has always been there for me. In Lithuania I also met very good friends I will always remember: María Salud Durán, Clara Isabel Tirado, Beatriz Irastorza, Julia Mackevič and Elana Siegel. Ah, and Jose Ruiz-Herrera, one of a kind.

In Lithuania I also (e-)met Prof. Jordi Albó Canals. I got to know Jordi because that previous summer I was supposed to go to his summer school on care robots – which got cancelled. More than 6 months later, I decided to schedule a Skype call with him to talk about his research. At that time I did not know that he would be one of the persons that helped me the most in my thesis (and that would turn my co-supervisor later on). I always say that the Erasmus Mundus Program put me in a very international level, Jordi put me on the right track concerning robotics. He encouraged me to organize a the workshop I did in Almere (which turned into a Workshop series over time), invited me to spend a summer in the Center of Engineering Education and Outreach (CEEEO) at Tufts University, MA, U.S. and encouraged me to go to Carnegie Mellon University in Pittsburgh. For that, I had to wait one year.

After that, I moved to Hannover. Prof. Daniel Strech welcomed me to the Center of Ethics and Law in the Life Science (CELLS) at Leibniz Universität. Hannover gave me freedom to focus on my research and encouraged me to go to conferences. There is where I started publishing my first conference papers. I do not know actually how did I manage to do so, because it was in the same period of time my grandmother passed away. It was April 2015. My brother called me and told me the news: *Iaia passed away*. *Iaia* is how we call in Catalan grandmothers. Her name was Consol

Lorente Carrión. She never knew exactly what I was doing, but she always was very supportive and very caring. She was convinced one day I would become someone very important. I will always love you Iaia.

After all these news, after Tufts, Germany... it was time to go back home. I had the possibility to stay 5 months in Barcelona. There I spent my days at the Universitat Autònoma de Barcelona, my alma mater. There I was with Prof. Antoni Roig Batalla, my main supervisor. Antoni has been with me since day one. I know him since my masters in 2011-2012. Antoni is one of those professors that sits next to you when you have to work on something together, not in front. Antoni has been always there for me, even when my personal life was trembling and I was not the nicest. Thank you for never abandoning me.

In Barcelona I could also stay with my family: my mother, my brother Albert Fosch Villaronga, my sister-in-law Eva Pérez Vega and my little nephew Eloi Fosch Pérez. They have always supported me. Although I think I might be the worst uncle on Earth, Eloi has always known how to put a smile on my face. At this point, he totally thinks I am a robot. He also thinks it is funny when I have lunch and he has dinner at the same time when I am in the U.S. Do not worry, Eloi, one day we will travel together there and we will eat at the same time.

I could have spent my whole third year in Barcelona. My supervisor was from there and I had to write my thesis, so there was apparently no reason to move somewhere else. Jordi told me, however, that he knew people at the Robotics Institute at Carnegie Mellon University and that it could be interesting to visit them. And I decided to go. This could never have happened without the immense help of Prof. Kevin Ashley and the Erasmus Mundus program. I met Kevin in December 2013 when he came all the way from Pittsburgh to Bologna to give us a seminar on Artificial Intelligence and the Law. Who would ever imagine that, 2 years later, I would ask him to move to Pittsburgh. He did everything he could to help me with my decision, and put me in contact with Prof. Ronald Brand, who gladly accepted me to the University of Pittsburgh School of Law. Since then, I have always come back to Kevin for advice. Thank you Kevin because you gave me the opportunity to live the American dream, and because you have always been there for me, to give me comfort in my future-related anxiety and to encourage me to continue doing what I am doing.

And I say American dream because that is how I felt when I was living there: doors would open if I knocked them. In Pittsburgh, my life was divided between Hillman Library, the School of Law of Pittsburgh, and the Robotics Institute in Carnegie Mellon University (CMU). Jordi introduced me to Mrs. Rachel Burcin, one of the most energetic persons I have ever met. Rachel is a happen-maker and has always a positive and encouraging life vision. Together with Prof. John M. Dolan, Isaak Isukapati and Dong Huang, Rachel managed to invite me to give a 2-day seminar in the undergraduate summer program in July 2016 and in 2017. From CMU, a big thank you to Prof. Jay D. Aronson and Prof. Alex J. London, and also to Henny Admoni and Laura Herlant for their support.

At CMU I also met Prof. Illah Nourkbahsh. Illah is bright and humble, and he always takes the time to meet the students, even if his agenda might be the busiest. We talked about my thesis and my projects. Illah is highly committed to educational and social programs, and he accepted to be part – as a keynote speaker – of the second edition of the Newfriends Conference on Social Robots in Therapy and Education in Barcelona. The funny thing is that he accepted even if we just met. Thank you Illah for helping and encouraging me to do things differently.

At a personal level, during my stay in Pittsburgh I met different people that played a major role on my life. The first is Dr. Angelo Jr. Golia, who at that time was “Mr” Golia, the very intelligent Mr Golia. We were neighbors, we were colleagues... we were friends. Like brothers, I would say. We shared everything, and the most important thing: we cared for each other and we stood by each other’s side when we had our moments of difficulty. We spent one month together with Dr. Eugenie Syx, another visiting Ph.D. student that made us a lot of company. Another person I will always remember is Matthew B. Freeman. I met him when he just arrived from a 3-year peace corps in Nepal, and we shared apartment. We spent countless nights cooking healthy and good food and talking about our trips, about our experiences with other cultures. Ashton Fagg was also in the house, and we shared a lot. A big thanks to Michael L. Vertullo too, my dearest Italo-American friend who showed me his beloved Pittsburgh and always helped and encouraged me.

In my Pittsburgh time, many other people opened the doors of such American dream. One of them was Prof. Kenneth Anderson. Ken is a professor at the Washington College of Law, but at that time he was visiting professor at Harvard Law School. Among many other things, he was the professor of the “Law and the Regulation of Emerging Robotics and Automation Technologies” study group, organized by the Berkman Klein Center for Internet & Society. Having the possibility to study at Harvard Law School had always been my dream. And the truth is that I did not receive any course on Law and Robots along my dissertation, and I decided to go to U.S. to take fully advantage of the mobility plan of my program, so I was willing to attend. The funny thing is that more than 100 persons applied and there was only room for 25, the course was compounded by 4 sessions (one each week) and I was going to miss one because I was attending WeRobot2016, and I was not in Cambridge area. Ken replied my email saying several things like “To be honest, this seems crazy to me” and “I must say, though, I admire your dedication!”. He accepted me. And I went. And I spent my days meeting incredible people like Aurelia Tamò (and also Christoph Lutz at WeRobot – we all three collaborate currently in many projects), but also Xuan Zhao and Mowafak Allaham from Brown University that invited me to give a talk to their lab with Prof. Bertram Malle, with whom we continue being in touch.

That summer I traveled to Zagreb, and I want to thank Maja Kamenar, a friend I met in an airplane. With Maja we share the love for Italy, Barcelona. We said that one day we would initiate the “Lithuanian Burano” project. Thanks for being there for me.

Other doors opened in New York, at academic and personal level. There in New York I have my dearest friends Linlin Tian and David Rivas who have host me countless of times in East Village. Linlin observes and reflects upon life in a very inspiring manner. We spend days and days walking the streets of New York, talking about life. Linlin loves walking. David is a happy laid-back young soul, a world traveller. They are the reason why I could do all my traveling: I always had a place where to stay. At an academic level, Prof. Aaron Saiger from Fordham Law School attended one of the workshops I did in 2015. I visited him back in February 2016 and he introduced me to Prof. Joel Reidenberg and Prof. Cameron N. Russel, who invited me to give a talk at the Center on Law and Information Policy (CLIP) in September 2016.

When I was in North America, some European doors opened too. Prof. Michiel Heldeweg offered me a postdoc position at the University of Twente, even if I did not have my Ph.D. yet. During the academic year 2016-2017 I have conducted research on exploring regtech-modes in responsible development and use of robotics. Michiel is another professor that cares, a person that sees problems (academically talking) and

tries to solve them. I admire the way he reasons and reflects upon legal problems and the vision he has. Thank you Michiel because you believed in me.

Another door that would fortunately open in the future was the one of Prof. Christopher Millard. I met him in Miami at WeRobot2016. After that, we have been meeting all over the globe thanks to serendipity, sharing hours and hours of deep conversations about the law, about life. Thank you Christopher for supporting my research and for your friendship.

Another person I want to thank is my beloved friend Laura Gimeno Pahissa. I think we might have spent around 432.933 hours on the phone with Laura over these 4 years. We talk. That is what we do. And share. And laugh. We always say that we are crazy, and that how lucky we are to be crazy. We have made good company to each other. Thank you Laura because you were always there for me.

Thanks also to Helena Heras. Helena was born artist, but we met at the School of Law. I was coming from my masters in Toulouse, and she was starting her double degree in Spanish and French Law. We always talk in French. She made some drawings for my thesis. Helena might be the younger sister I never had. The beauty of our friendship is that it has evolved and grown as we have matured and become young adults. And this is what happened with my friends Blanca López Bassa, Yuting Chang, Carmina Castellano Tejedor, friends that have always been there for me, for my good and my bad moments. And this counts also for you, Alessandra Malerba, my dearest friend from the Erasmus Mundus. You will always be in my heart.

I want to thank also Beste Özcan and Alex Barco Martelo. We have a whatsapp group called “why be normal?”. I remember that they we created it. It was in Barcelona, in Born district. We were in a small bar, laughing like crazy, sharing all these adventurous lives of ours and there was a moment I said “oh, sometimes I would like to have a more normal life”, but Beste quickly replied “why? Why be normal?”. Exactly, why be normal. I love you guys.

My last thank you is for my mother. For her unconditional love, for her unlimited patience, love and caring. Mama, you are an example of strength, courage and responsibility I have not seen elsewhere. You are my role model and the reason why I am where I am, because you always taught me that “no” does not exist in our dictionaries. I admire you because you never gave up, not even in the most challenging moments of your life. Thank you for always believing in me, for encouraging me to live the life and to stand always by my side, especially when I need you the most. I love you Mama.

Introduction

"The art of progress is to preserve order amid change, and to preserve change amid order". Alfred North Whitehead.

1. Robot Technology in Healthcare

Most of technological advances aim at making our lives easier and longer. This not only increases the demand on Healthcare – the older we get, the more medical assistance we need – but it also raises healthcare costs. In addition, the reduction of the birth rate necessarily leads to a diminution of the welfare-state contributors.

Due to the demographic regression in the developed countries, the number of persons who may potentially take care for elderly people has dramatically decreased. For every person over 65 years of age there are four people under that age capable of caring for that person¹. However, the lack of time and expertise leads caregivers to refer elderly people to expensive nursing homes. According to the French Observatoire-des-EHPAD KPMG 2013 report, "the monthly cost of a nursing home is, on average, €1,857 [...] when the average pension for French women, representing the majority of the residents, is €900 per month"². The Genworth's 2013 Cost of Care Survey also establishes that "the median annual cost of private nursing home care has jumped 24%, from \$67,527 to \$83,950 in US when seemingly salaries are not increasing equally"³. The worst is yet to come: Colin Angle argues that by 2030 the ratio of the elderly: caregivers will become 1:1, or, in UN words: "older persons are projected to exceed the number of children for the first time in 2047"⁴.

This strongly affects the position of elderly people in society. How can the current welfare system manage 100-year-old people? How can society afford this phenomenon both financially and in terms of time? Nursing homes help largely to take care of the aging society; however, are they safe enough for elderly people? Unfortunately, sometimes nursing homes fail to meet some settled requirements. For example, the Annual Report and Accounts – Care Quality Commission in the UK established, in relation to nursing homes that "[...] while many were delivering good care, more than half of those 100 acute NHS hospitals inspected needed to make improvements and

¹ See Colin Angle's Speech in TedMed (2009): Will a Robot Care for my Mom? www.tedmed.com/talks/show?id=7193.

² See KPMG: Observatoire des Établissement d'hébergement pour personnes âgées dépendantes [EHPAD] (Janvier 2013).

³ See Genworth: Cost of Care Survey. Home Care Providers, Adult Day Health Care Facilities, Assisted Living Facilities and Nursing Homes. 10th Edition (2013).

⁴ See UN: World Population Ageing 2013. United Nations, Department of Economic and Social Affairs, Population Division (2013). ST/ESA/SER.A/348.

one in five was failing to meet the essential standards [...]”⁵. Thus, can nursing homes really supply all the services our (grand) parents need?

Many try to address the ageing-society phenomenon from different perspectives, like Hoffman from the gerontology’s point of view⁶, Fisk from the psychology’s one⁷, or Kuh et al. from a more general and interdisciplinary perspective⁸. Technology seems an efficient response to tackle challenges associated with ageing, and in particular, personal care robots (*see* Fig. 1).

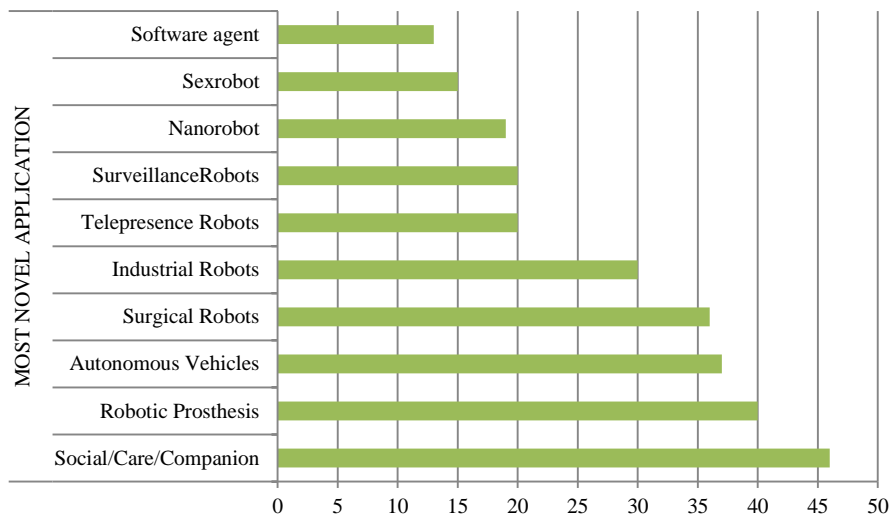

Figure 1 Robolaw project’s survey. Source Deliver 6.2. Guidelines on the Regulation of Robotic Technology⁹.

Personal care robots can help patients, elderly and handicapped people in their daily needs, either in the hospital or at home. They can enhance a person’s physical capabilities or they may help nurses to better take care of patients. Yet, there are still many unanswered questions: which are the activities that humans can (or should) delegate to machines? What happens when a machine enhances a patient’s sanity? Can robots cause denial to access medical care? Are robots liable for their behavior when reacting autonomously to environmental stimuli? Will patient care become a depersonalized approach? How can we anticipate the future? Will robots deliver a good care? Are people prepared for this phenomenon? These and many other questions need to be considered.

Considering the huge impact that new technologies are already having on the legal domain and because robotic technology is increasingly being used to solve society’s problems, this thesis will focus on the insertion of autonomous service robots in

⁵ See CQC: Annual Report and Accounts. Care Quality Commission, p.13. United Kingdom (2011-2012). See also Homer A.C., Gilleard C. (1991) Abuse of elderly people by their carers. *British Medical Journal*, ed. 9 pp.1359-1362.

⁶ See Hoffman, C. (2013).El método Hoffman [The Hoffman’s Method]. *Revista de Terapia Ocupacional*, vol. 10, num. 8, pp. 18-23

⁷ See Fisk, A.D.; Rogers, W. A. (2002) Psychology and Aging: Enhancing the Lives of an Aging Population. *Current Directions in Psychological Science*, vol. 11, num. 3. American Psychological Society

⁸ See Kuh, D. A Life Course Approach to Healthy Ageing. Oxford University Press (2014).

⁹ Survey available at: docs.google.com/forms/d/e/1FAIpQLSdEBUgMDZH_TK3FonIFQu_Gxh2_wizgnTIDvbaUH8d5JEVynw/viewform

healthcare institutions (personal care robots) as a response to the care system's shortcomings. Both legal and ethical aspects will be considered.

The robotic response facing the ageing of society will bring about yet unknown scenarios that are worth a thorough analysis. In fact, there are no laws governing this precise technology yet - only some guidelines on the use of drone technology and autonomous driving are currently available (*see infra*). To be more precise, this technology can revolutionize the care system and can make a difference for elderly, or disabled adults and children. Clearly, this is a delicate topic, and it includes a wide range of aspects. Consequently, a new, multidisciplinary approach is the most suitable strategy and it will be useful to address new upcoming challenges.

2. Recent developments on Healthcare Service Robotics: Personal Care Robots

Among the different technologies, this thesis will focus on Personal Care Robots. This assistive technology can help a wide range of users in their daily needs because they “perform useful tasks for humans or equipment excluding industrial automation applications”¹⁰. Although there are regulations for autonomous cars¹¹ and guidance for drone technology^{12,13}, it is not clear what regulations apply to personal care robots. What we do in this thesis – similar to van den Berg¹⁴ - is to bring the legal debate on personal care robots to the earlier stages, when robots are designed, so as to avoid ex post remedies once mass-produced.

Robotics represents a new step in healthcare, not only from a technological viewpoint (Fig. 1), but also from a legal and ethical perspective. Indeed, “Law and Robotics” is quite a new field. Robots are a growing technology¹⁵, and further research on the legal/ethical implications of this technology is needed. Some efforts have been made to address the issues in automated driving and in drone technology¹⁶, and similar efforts are now also necessary to clarify the appropriate use of other types of

¹⁰ ISO 8373:2012 Robots and Robotic Devices – Vocabulary

¹¹ In the United States, the National Conference of State Legislatures compiles the regulations of the States on autonomous cars: www.ncsl.org/research/transportation/autonomous-vehicles-legislation.aspx

¹² On 29th August 2016 the new regulation on Unmanned Aircraft System was released under the Federal Aviation Administration, *see*: www.faa.gov/uas/

¹³ For European rules on drones, *see* also dronerules.eu/en/.

¹⁴ That is why we have been organizing a workshop series since 2015, on the legal and ethical aspects of social robots in therapy and education. Visit legalaspectsofsocialrobots.wordpress.com for the workshops in 2016 and 2017, and legalrobotics.wordpress.com for the workshop in 2015.

¹⁵ *See* TMR: Medical Robotic Systems Market. Global Industry Analysis, Size, Share, Growth, Trends and Forecast (2012-2018). Transparency Market Research (2013).

¹⁶ *See* Pillath, S. (2016) Automated Vehicles in the EU. European Parliament Research Service. Available at: ec.europa.eu/transport/themes/its/studies/doc/2012-its-and-_personal-data-protection_-_final_report.pdf. *See* also the G7 declaration on automated and connected driving ec.europa.eu/commission/2014-2019/bulc/announcements/g7-declaration-automated-and-connected-driving_en; *see* also Automated Driving Roadmap (2015) from the European Road Transport Research Advisory Council Available at: www.ertrac.org/uploads/documentssearch/id38/ERTRAC_Automated-Driving-2015.pdf. For a compendium of legislation on self-driving vehicles in the U.S. visit the website of the National Conference on State Legislation: www.ncsl.org/research/transportation/autonomous-vehicles-legislation.aspx. For drones, *see* European Aviation Safety Agency EASA (2015) Introduction of a regulatory framework for the operation of drones at www.easa.europa.eu/system/files/dfu/A-NPA%202015-10.pdf. For its American version, *see* the Small UAS Rule (Part 107): Federal Aviation Agency (August 2016) Operation and Certification of Small Unmanned Aircraft Systems. Available at: www.federalregister.gov/documents/2016/06/28/2016-15079/operation-and-certification-of-small-unmanned-aircraft-systems

technology. Otherwise, the lack of legal clarity will leave device-makers, doctors, patients and insurers in the dark¹⁷.

Undoubtedly, there has been a long research in robotics involving some important, related disciplines (mathematics, cognitive science, robotics, neurosciences, engineering, computer science, philosophy). Many collaborative efforts have been made to deal with psychological challenges associated with robots (therapeutic robots mainly and their impact on society¹⁸). Unfortunately, personal care robots have been scarcely investigated within the legal community¹⁹. Only few scholars have so far discussed law and robotics topics in general (mainly the WeRobot community in the United States²⁰, the Robolaw project in the European Union²¹ and the Robolaw.Asia initiative in China²²). Those who have addressed these aspects have mainly focused on philosophical-general discussions^{23,24} and all-inclusive kinds of robots, especially unmanned automated vehicles (aerial and ground vehicles) but lately also other types of robots such as surgery robots or prosthetics. Nonetheless, there is little research on the personal-care domain and on this specific kind of robots from a legal perspective. In reality, an interdisciplinary approach involving law and robotics is still lacking, although urgently needed²⁵.

Only on 1st February 2014 the International Standard Organization (ISO) introduced the ISO 13482 about “Robots and Robotics Devices – Safety Requirements for Personal Care Robots” where they gave a definition of service robot and also of personal care robot. ISO is in charge of developing and publishing International Standards as well as the European Standard Organization (ESO). These standards “help to harmonize technical specifications of products and services making industry more efficient [...] reassure consumers that products are safe, efficient and good for the environment”²⁶. These documents are intended to tackle the challenges of modern business and help all the involved stakeholders: it fosters decision makers to understand the specificities of the products and decide whether to make the ISO a regulatory requirement (because they are voluntary); it contributes to save costs, enhance customer satisfaction and access to new markets; and in general it helps society to accept new products as safe and efficient.

¹⁷ Anonymous, “You, Robot?” The Economist, September 2012

¹⁸ If you have a look to the EUCog – European Framework for the Advancement of Artificial Cognitive Systems, Interactions and Robotics you will see that within the disciplines they deal with, there is also psychology. See <http://www.eucognition.org/index.php?page=statistical-data>.

¹⁹ We could quote the www.robolaw.eu project but its aim is *to investigate the ways in which emerging technologies in the field of (bio-) robotics have a bearing on the content, meaning and setting of the Law*. However, within the classification of the roboethics roadmap, we are going to address *assistive technology* and *no bio-robotics technology*, but in any case, have a look to: www.roboethics.org/atelier2006/docs/ROBOETHICS%20ROADMAP%20Rel2.1.1.pdf.

²⁰ See the latest edition that is going to be in Yale, US, at www.werobot2017.com

²¹ See <http://www.robolaw.eu>

²² This community has not provided any knowledge so far. In any case, see the initiative at www.robolaw.asia

²³ See among others Chopra, S. and White L.F. *A Legal Theory for Autonomous Artificial Agents*. University of Michigan Press (2011); and Floridi, L. and Sanders, J. W. *On the Morality of Artificial Agents*. *Minds and Machine*, num. 14, pp. 349-379. Kluwer Academic Publishers (2004).

²⁴ Massaro, T. N. and Norton, H. (2016) *Siriously? Free Speech Rights and Artificial Intelligence*. *Northwestern University Law Review*, v. 110 forthcoming. See robots.law.miami.edu/2016/wp-content/uploads/2015/07/SeriouslyNOV8.pdf

²⁵ This is because of the Resolution of the European Parliament that is pushing the European Commission not only to draft a Directive on these topics but also on the creation of a European Robot Agency which could take over these topics.

²⁶ See Benefits of International Standards in www.iso.org.

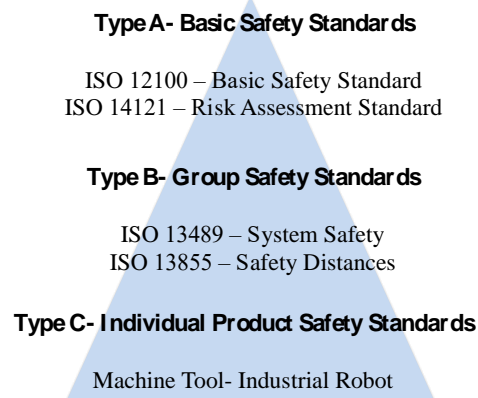

Figure 2 Hierarchical Structure of International Standards (ISO/IEC) ²⁷

There are three types of ISO (*see* Figure 2): A, intended to address basic safety standards (like ISO 12100); B, tackling group safety standards; and C, individual product safety standards. ISO 13482:2014 refers to type C. Thus, it aims to eliminate/reduce the risks associated with the possible hazards that Personal Care Robots as individual products may cause. ISO 13482:2014 standard only concerns harm-related and technological-based requirements, whereas other important legal or ethical questions are not taken into account, - such the unauthorized surveillance of patients, the misuse of the collected data, ethical issues regarding the patient and the relatives, the impact of robot's admission the institution (e.g. the loss of jobs if any), etc.; this *corpus* is going to be our starting point.

As we will see, standard compliance does not always imply satisfaction of end users' expectations. Although standards ensure safety, safety is only one of the principles addressed by Law. In fact, the regulation of new technologies should find a balance between the four constraints: technical norms, Law, the market and social norms²⁸, among others, e.g. burdening or overburdening a new technology before it is fully developed.

Industrial standards are technical norms that are considered soft Law²⁹. Soft legislation provides good alternatives for dealing with new, complex international issues, especially in those cases when it is hard to predict the consequences of a legal document. Standards are flexible, they are a tool for compromise, and sometimes they are the basis of legal corpuses. Some examples are the Machinery Directive 2006/42/EC or the Medical Device Directive 93/42/EEC³⁰. Of note, standards are non-binding and are voluntarily adopted; and standards related to personal care robots are not exception³¹.

²⁷ See Nakabo, Y. Safety of Personal Care Robots as an Example of Consumer Devices. OMG Technical Meeting Special Event. Seminar on Systems Assurance & Safety for Consumer Devices: Automotive, Robotic & Building Automation Systems for the Future (2011).

²⁸ Lessig, L. (2006) Code Version 2.0. Basic Books, NY, p. 121. *See* also the Guidelines on Regulating Robots (2014), Deliverable D 6.2 of the EU Robolaw 7th Framework Program Project (2012-2014).

²⁹ Shelton, D. (2003). Commitment and compliance: The role of non-binding norms in the international legal system. Oxford University Press on Demand

³⁰ See ec.europa.eu/growth/single-market/european-standards/harmonised-standards/index_en.htm *See* also Krut, R., and Gleckman, H. (2013). ISO 14001: A missed opportunity for sustainable global industrial development. Routledge

³¹ *See* www.bsigroup.com/LocalFiles/en-GB/consumer-guides/resources/BSI-Consumer-Brochure-Personal-Care-Robots-UK-EN.pdf

European Parliament proclaimed a resolution with several recommendations to the European Commission on Civil Law Rules on Robotics as *lege ferenda*. The Parliament expects the Commission to draft a piece of legislation (probably a Directive) foreseeable in 10-15 years, but in the meantime current roboticists do not have any concrete guidelines, especially for personal care robots. This creates a situation of uncertainty about their current and future creations, particularly in terms of ethics, liability, and trustworthiness of robots. In addition, also this report released by the Parliament leaves many relevant questions open. This

Apart from wondering whether this robotics legislation will be obsolete once it will enter into force (and characterized by discrepancies between the Member States if the chosen instrument will be the Directive), current roboticists still wonder what is the applicable legislation now and during the transition time.

The lack of concrete guidelines from the European Parliament on this precise technology makes this topic even more relevant and urgent. The grounded knowledge that will be described here can be used to inform a future regulation on the use of personal care robot technology. Here we will try to analyze and summarize the main aspects roboticists have to come to terms with today, particularly regarding personal care robots. Such analysis could help create more awareness among robot creators and also lawmakers, and it can be used for a future definition of a legal and ethical framework that should be applied to personal care robots.

3. Research questions

The introduction of personal care robots is a multifaceted issue. This demands an integrative and versatile approach that can consider technological and legal issues and impacts. Therefore, this thesis will address the following research questions:

1. What are the different types of personal care robots and what are the differences between them?
2. What are the major legal and ethical issues raised by such technologies and how can roboticists and lawmakers address them in the future?

This thesis is an *ex ante* appraisal and can be a starting point for future discussion at a higher regulatory level. In order to answer the above questions, an analysis of the current state of the art of the regulatory framework concerning personal care robots will be carried out. Before analyzing the state of the art, two relevant considerations should be made:

1. Although analyzing potential legal issues associated with personal care robots in terms of legal principles may be too abstract, a risk-based approach using technology-tailored impact assessments can add a necessary level of precision.
2. Accountability tools – impact assessments – should not only foster roboticists' legal compliance, but also encourage regulators to develop guidelines that recognize the particularities of each technology – which could help create safer technology.

The main idea is to assess the impacts of personal care robots. Our aim is to identify, beyond security and safety issues, human-robot interactions that can pose a challenge to the legal and ethical domain and to give a clear, effective, international and interdisciplinary response. This will be helpful to all the stakeholders involved in the

lifecycle of the robot – from its creation to its implementation. For those who build personal care robots, useful analyses of robot legal compliance can be found at:

- a. Analysis of person carriers: chapter 3 part A section 5.
- b. Analysis of physical assistants: chapter 3 part B section 5.
- c. Analysis of mobile servants: chapter 4 section 5.

Robots are highly heterogeneous, and the “one size fits all” approach is clearly not applicable in legal terms. Based on the grounded knowledge extracted from the impact assessment analysis, we aim at identifying existing regulatory gaps and potential issues for personal care robots. The idea is to provide lawmakers with relevant field study information for their discussions on whether these technologies should have an independent *corpus iuris* or not. This can pave the way to a future definition of a specific legal framework for personal care robots, and it can also clarify the necessary legal safeguards that should be applied when designing personal care robot technology. Specific considerations that may be relevant to lawmakers can be found at:

- a. Considerations for lawmakers: chapter 5.

4. Methodology

Ten years ago, the concept “law and robotics” practically did not exist. Only few legal scholars addressed the legal implications of robotic technology back then³². The first steps towards addressing other sides of robotic technology came from ethicists, philosophers or engineers themselves reflecting on the consequences of their technology. During the last five to seven years, legal scholars from around the globe became more interested in this concept and started writing academic papers on it, either in journals or in conferences. In 2010 and later on in 2012, Europe recognized the importance of the topic and conceded research projects that specifically addressed the topic (mainly the EuRobotics initiative that addressed different legal aspects challenged by robots³³) and the Robolaw Project that addressed concrete types of robots (including self-driving cars, computer integrated surgery, robotic prostheses, and care robots³⁴).

On the U.S. side, a conference on the legal and policy issues of robots (WeRobot) began in 2012³⁵, attracting the attention of pioneer researchers that envisioned robots challenging the regulatory system in different manners. Over the years, the articles included in this conference series addressed a very wide range of topics, including military robots (2012, 2016), sex robots (2012) physical injuries (2012), privacy (2013, 2016), morality (2012, 2016), ethics (2013, 2016), intellectual property (2013, 2015),

³² See Nguyen, H. G., & Bott, J. P. (2001, February). Robotics for law enforcement: Applications beyond explosive ordnance disposal. In *Enabling Technologies for Law Enforcement* (pp. 433-454). International Society for Optics and Photonics. See also Asaro, P. M. (2007). Robots and responsibility from a legal perspective. *Proceedings of the IEEE*, 20-24.

³³ euRobotics - The European Robotics Coordination Action (2010-2012) ELS Issues in Robotics. Grant Agreement Number: 248552 01.01.2010 – 31.12.2012. Instrument: Coordination and Support Action (CSA). See also RockEU - Robotics Coordination Action for Europe (2013-2016) ELS issues in robotics and steps to consider them. Grant Agreement Number: 611247 17.01.2013 – 16.07.2016 Instrument: Coordination and Support Action

³⁴ Regulating Emerging Robotic Technologies in Europe: Robotics facing Law and Ethics (2012-2014) FP7 Funded Project, Project ID: 289092

³⁵ See robots.law.miami.edu

consumer robots (2015-2016), social aspects (2014-2016), regulatory aspects (2012, 2014-2017), healthcare robots (2014, 2015), witnesses (2012, 2016) and others³⁶. In 2013-2014, we followed mainly the above-mentioned projects and conference, and we started reading on robots, mainly the work from Chopra and White³⁷, Pagallo³⁸ and Hallevy³⁹. At the beginning of this work, several laws concerning self-driving cars appeared in the U.S, thus making a big step forward in the legal discussion about such technologies.

Nevertheless, the analysis of the state of the art pointed out a major problem, which is the appropriate translation and application of fundamental legal research into concrete scenarios with particular robot technology. In other words, while philosophico-juridical research was promoting high-level discussions, roboticists building a precise technology would wonder what all that meant for their particular case. Legal actions seemed to lack more technology-specific solutions – especially in domains like healthcare, education or therapy.

The summer school on care robots organized in 2014 in Almere⁴⁰ seemed to be a great opportunity to go deep in the analysis of care robots, but unfortunately that course never took place because there were not enough participants registered. Nevertheless, the Medical and Service Robots (MESROB) Summer School in Lausanne, Switzerland in the same year represented a vital source for this thesis, and, of note, it was the first time that a legal scholar attended such event. Many of the robot types analyzed in this thesis were presented in that summer school, and each one of them was born with a concrete purpose: help people. From exoskeletons that helped more-than-10-year wheelchair users stand up, to little robots that could check whether elderly were in the bedroom or in the kitchen during sleeping and eating hours.

Choosing to address care robots was a personal decision: Prof. Francesco Mondada presented the results of the 2012 Eurobarometer on public attitudes towards robots. This study revealed that 60% of the interviewed population would ban robots involved in the care of children, elderly or disabled (*see* Fig. 3), although there was a growing community working on this type of technology. Roboticists highlighted that there was no legislation or guidelines on the topic, something that would be confirmed two years later⁴¹. Seeing the discomfort of the population with care robots, the predictions in growth of this technology of the Robolaw project (*see* Fig. 1), and the lack of guidelines on the topic, we decided to frame our work under personal care robot technology.

³⁶ This conference has been held in Miami University, Stanford University, Washington University and Yale School of Law. The topics of the papers are accompanied with the year papers have been appearing, although this is not an exact review.

³⁷ Chopra, S., & White, L. F. (2011). *Op. cit.*

³⁸ Pagallo, U. (2013). *The laws of robots. Crimes, Contracts, and Torts*. Berlin, Dartmouth: Springer.

³⁹ Hallevy, G. (2013). *When Robots Kill: artificial intelligence under criminal law*. UPNE.

⁴⁰ *See* lasallealmere.nl/course/caring-robots/

⁴¹ Bottalico, B. et al. (2016) ELS issues in robotics and steps to consider them. Part 2: Robotics and Regulations. ROCKEU Robotics Coordination Action for Europe. The document only includes 2 pages on Healthcare robots. *See* www.eu-robotics.net/cms/upload/downloads/Rockeu1/2016-08-16_RockEU_deliverable_D3.4.1-part2.pdf. For a more graphic representation on the missing regulations see Part 3 ethics of the same project, available at: www.eu-robotics.net/cms/upload/downloads/Rockeu1/2016-08-16_RockEU_deliverable_D3.4.1-part3.pdf

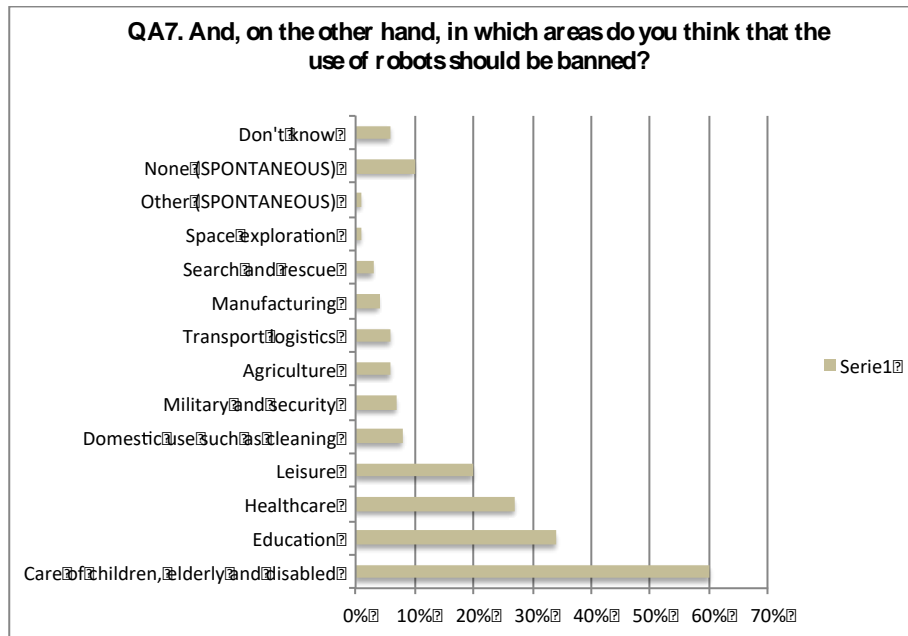

Figure 3 Robots that should be banned. Extracted from eurobarometer 2012

After choosing this innovative topic, we conducted a normal literature review. Systematic reviews are common in medical research, but present great complexity in social science due to considerable diversity in research design⁴². Despite the novelty of the topic, we tried to be as systematic as possible. The literature reviewed was mainly drawn from the above mentioned projects and conferences, but also from different databases. These databases include, for legal research mainly: ScienceDirect Elsevier (social science), Oxford Scholarship Online, HeinOnline, Google Scholar, SSRN, JSTOR, PubMed, USA.gov and LexisNexis. For engineering research mainly: ACM Digital Library, IEEE Xplore, ScienceDirect Elsevier (science), SpringerLINK. We used a combination of many keywords – including personal care robots, robot impact assessment, person carrier robots, physical assistant robots, mobile servant robots, legal aspects, privacy and human-robot interaction – that had to be refined over time in order to identify the appropriate relevant literature⁴³:

- 1) for personal care robots other keywords were used: personal robot, social robots, companion robot, care robot, service robot, domestic robot, healthcare robots;
- 2) for person carrier we used: wheeled mobile robot, robotic wheelchair, person mobility carrier, intelligent walking assistant;
- 3) for physical assistant: exoskeleton, symbiotic robots, walking assistant robot,
- 4) for mobile servant robots: assistant robot, robot assistive technology, servant robot, mobile robot, social robot,

⁴² Viebrock, E. (2008). Systematic literature reviews as a tool for evidence-based policy. *ECPR Joint Sessions in Rennes*, pp. 11-16.

⁴³ We believe that is due to the novelty of the standard ISO 13482:2014 at the time of the search.

From the resulting articles, those more relevant to the current work – based on the relevance of title, subtitle and abstract – were included in the review. A further selection was made according to the following criteria: articles that focused on legal aspects of healthcare-related robots (privacy, consumer robots, liability, autonomy), articles that focused on technical aspects of these robots (motion planning, safety, technology applied to them, technical characteristics). The articles were published between 2010 onwards, and we tried to focus on the latest and most updated available literature.

One of the problems that we encountered was that legal research concerning personal care robots was scarce and did not really follow common criteria. Moreover, all the research stuck to the top-down approach, i.e. majority of the articles focused on how existing regulations would be suitable for the upcoming challenges. On the technological side, the articles focused primarily on fundamental research basis, or on technological improvements of existing technologies – motion planning, robustness of the robotic platform – and the information was very scattered. The problem was how we could identify the impacts that current technology could pose to the (existing) regulatory framework. In order to frame the information available – based on the analysis of state of the art and the collected articles – we used a risk-based approach (which is explained later in the following chapters). This approach is advantageous because it tries to avoid miscommunications between regulators and robotic developers regarding what should be taken into account in the development of a technology – a sort of compliance-by-design system. Such approach allows developers to address legal compliance in a bottom-up basis. In addition, in this thesis we go one-step forward: starting from that compliance knowledge, we made some suggestions for future discussions on the policymaking side.

To get to this point, we first investigated analogous frameworks – mainly privacy and surveillance impact assessment. The problem with those frameworks was that a robot could challenge and impact the regulatory system in various ways, not only in privacy or surveillance matters. That is why we constructed a technology-specific framework – the care robot impact assessment – thus allowing us to pool together all the different impacts into one instrument. Moreover, we conceptually tested the framework in a company working on robotic technology – Adele Robots (Asturias, Spain) – and Ph.D. visiting-scholar stays to different research centers – CEEO Tufts University (with Prof. Dr. Jordi Albo-Canals, in Medford, MA, US) EPFL (with Prof. Dr. Mohammed Bouri, in Lausanne, Switzerland). The framework was also presented at the International Conference of Social Robots held in New York in the summer 2015, and it received a good acceptance from the audience⁴⁴. As a result, we were able to raise the awareness of the researchers and persons we interacted with, and – thanks to the positive feedback – we also defined the structure of this thesis: a recurrent pattern has been adopted, including an analysis of the context, information of the robot type and legal analysis in every chapter.

After choosing the discipline – healthcare/personal care – and knowing how we would frame the discussion around it from different disciplines – using an impact assessment that would get together engineers and regulators – we found out that there were much more types and sub-types of robots than we imagined. Since carrying out a complete impact assessment on all the aspects and all the sub-types of robots in this work could not be possible, first we decided to focus on the aspects that the Robolaw

⁴⁴ Fosch-Villaronga, E. (2015) Creation of a Care Robot Impact Assessment. WASET, International Science Journal of Social, Behavioral, Educational, Economic and Management Engineering, 9(6), pp. 1817 - 1821

project focused for care robots chapter: fundamental rights, independence and autonomy in the light of independent living and participation in community life, equality and access, liability and insurance, privacy, and the legal capacity and legal acts performed by robots. Safety, responsibility, autonomy, independence, enablement, privacy and justice were included in the ethical analysis of the Robolaw project too. We grouped them into different categories – safety, consumer robotics, liability, user rights, autonomy, dignity, ethics and justice – and we organized our thesis accordingly.

Second, we decided to select and analyze one (sub)sub-type of each sub-type of personal care robots – person carrier, physical assistant and mobile servant robot. A limitation may be that we selected robots mainly based on our personal experience and interactions with their researchers and creators. For person carriers we decided to use some of the work Prof. Dr. Albo-Canals conducted in the follow-me project in Sitges, Barcelona⁴⁵, we used examples of the exoskeletons of the group of Mohammed Bouri (and the work of Jeremy Olivier) in EPFL, in Lausanne (Switzerland)⁴⁶ and Andrey Yatsun in Russia⁴⁷, and we used the robot that Prof. Dr. Aleksandar Rodić presented at MESROB 2016⁴⁸.

The collected information from the relevant literature was framed into the different robot-specific chapters under the context, robot type and legal analysis sections. The legal analysis sections include both an analysis of the problems, and, in most of the cases, a solution linked to that problem, which has been summarized in a reader-friendly chart at the end of each chapter. This chart has been configured after the completion of each section. As done in a recently published work on this topic⁴⁹, we decided to add a short story that would better exemplify the impact in each of the cases. The stories have been inspired by different real cases (quoted as long as they appear), by movies or simply by our imagination.

Afterwards, we identified some recurrent topics, issues and gaps that may need to be addressed by regulatory bodies – or at least to be incorporated into their discussions and created a chapter for it. By regulatory bodies we refer to any level: public and private; the municipality that is asked permission to conduct certain experiments; researchers developing a robot; a higher transnational body like the European Union that since 2017 – after the resolution of the European Parliament – is considering the possibility to develop civil rules for robots.

This chapter was inspired by the document of the European Parliament Research Service of 2012 that addressed “Legal and Ethical Reflections Concerning Robotics”. This document is a policy briefing that identifies the areas of interest and concern, possible issues and challenges of cyber-physical systems in selected policy areas, including transport, trade, civil liberties, safety, health, energy and environment, and horizontal issues⁵⁰. The selection criteria for each of the issues and challenges in our work have not been randomly chosen, but have been collected as a consequence of the previous work.

⁴⁵ See <https://institutorobotica.org/en/projects/follow-me/>

⁴⁶ See <http://lsro.epfl.ch/page-118584-en.html>

⁴⁷ See <http://exomed.org>

⁴⁸ Rodić, A., Vujović, M., Stevanović, I., & Jovanović, M. (2016). Development of Human-Centered Social Robot with Embedded Personality for Elderly Care. In *New Trends in Medical and Service Robots* (pp. 233-247). Springer International Publishing.

⁴⁹ Fosch-Villaronga, E. and Roig, A. (2017) European Regulatory Framework for Person Carrier Robots. Computer Law and Security Review. Forthcoming.

⁵⁰ Kritikos, M. (2012) Legal and Ethical Reflections Concerning Robotics. STOA. Available at: [www.europarl.europa.eu/RegData/etudes/STUD/2016/563501/EPRS_STU\(2016\)563501\(ANN\)_EN.pdf](http://www.europarl.europa.eu/RegData/etudes/STUD/2016/563501/EPRS_STU(2016)563501(ANN)_EN.pdf)

The analysis of the concrete sub-types of personal care robots helped us answer the two main research questions of the thesis. Indeed, it helped us to better understand personal care robots and the different types, and also to clarify the confusion with other established categories. Furthermore, it can be a valid way to frame the discussion so that roboticists can incorporate legal aspects into their creations, and lawmakers can think how to address innovation from a bottom-up-more-realistic approach.

5. Structure of the thesis

Our work is divided in different sections. After a general introduction to the current work, chapter 1 introduces the concepts of robot, service robot and personal care robot. All the different sub-types of personal care robots are also described in chapter 1. Based on the current type of social robots, chapter 1 also tries to devise whether personal care robots are considered social or non-social robots. The need for a particular regulation that governs personal care robots is also reported. This chapter concludes with an explanation of robots excluded from the personal-care scope.

Chapter 2 describes the current legal framework for personal care robots. This framework is based mainly on an industrial standard that governs safety requirements for personal care robots; relevant literature on a framework for personal care robots, mostly the European Robolaw project and academic articles, are also included. The problems related to the state of the art are illustrated after that. Chapter 2 includes the methodology used for the compliance process of roboticists building personal care robots – impact assessment. A connection between accountability tools and meaningful regulatory frameworks is explained to explain what we do in the thesis and conclude this section.

Chapters 3 and 4 conduct an assessment of the impacts of personal care robots. Chapter 3 is divided in Part A – for person carriers – and Part B – for physical assistant robots. Chapter 4 addresses the impacts of mobile servant robots. These two chapters are divided in different sections. Section 1 of each chapter introduces the chosen robot, section 2 describes the context of use of such a robot, section 3 introduces a minutely description of the characteristics of that robot, section 4 analyzes the impacts at the legal level. An example of a legal risk scenario can be found at the top of each sub-section of section 4. Section 5 includes a chart of legal compliance guidelines for each robot type.

Subsequently, some gaps and relevant issues for lawmakers' discussions can be found in Chapter 5. This Chapter is divided between general information for personal care robots, and concrete information for each type of robot.

The conclusions close this thesis. These conclusions include lessons learned and achieved goals. Based on all our analysis and study, an explanation of how we envisage the future of law will be also presented as a concluding remark of the thesis.

6. Reading paths

6.1. For personal care robot creators

- Chapter 3 part A and part B and Chapter 4 have technical description and definition of the robot.
- Examples of legal risk scenarios are at the top of each sub-section of section 4 “Risk Scenarios” in Chapter 3 part A and part B and Chapter 4.

- Safety aspects (including physical and cognitive safety aspects) can be found in section 4.1 of chapter 3 part A, part B and chapter 4
- Liability and responsibility matters can be found in section 4.3 of chapter 3 part A, part B and chapter 4.
- If interested in marketing a robot, *see* the consumer robotics section (4.2) of Chapter 3 part A and part B and Chapter 4.

6.2. For legal scholars

- A general description of each robot type (including pictures) can be found in chapter 1, section 3.
- A more detailed description of each robot type – including robot capabilities and technology applied to the robot – can be found in section 3 of chapter 3 part A, part B and chapter 4.
- If interested in the context of use, section 2 of chapter 3 part A, part B and chapter 4 describes them.
- Examples of legal risk scenarios are at the top of each sub-section of section 4 “Risk Scenarios” in Chapter 3 part A and part B and Chapter 4.
- Legal scholars that might be interested in data protection issues can find all the related information in the section 4.4. “User Rights” of chapter 3 part A, part B and chapter 4.
- Confusing and mixing categories can be found in chapter 1 section 5, and also in section 1 of Chapter 3 part A and part B and Chapter 4.
- For ongoing discussions on replacement of human workers and dignity matters, *see* section 4.6 of Chapter 3 part A and part B and Chapter 4.
- To know more about the ethical implications of personal care robots, *see* sections 4.7 of Chapter 3 part A and part B and Chapter 4.

6.3. For law and policymakers

- For current legal framework and state of the art of personal care robot discussions, *see* chapter 3.
- For a technical legal framework for personal care robots, *see* section 5 of Chapter 3 part A and part B and Chapter 4.
- To see a list of areas of interest, concern and possible issues and challenges concerning personal care robots, *see* chapter 5.

1. Chapter - Personal Care Robots: Description and Regulatory Needs

“I can’t define a robot but I know when I see one”. Joseph Engelberger⁵¹

1. Definition of Robot

Precise terminology has always been important⁵², even if “definition is not a final outcome but a single step in a long process of understanding”⁵³. Terminology is still the main reference we have to acknowledge and define concepts, ideas or notions. This is a key element when we try to use the same concepts in different fields (the legal and technological fields) because those definitions will lead us to know the “exact statement or description of the nature, scope or meaning of [that] thing”⁵⁴.

According to Minsky, when things are hard to describe we can “start by sketching out the roughest shapes to serve as scaffolds for the rest [...], draw details to give these skeletons more lifelike flesh [*and*] in the final filling-in, discard whichever first ideas no longer fit”⁵⁵. Similar, robotics terminology is still developing and is not consistent across research and regulatory stakeholders⁵⁶. An accurate description nevertheless is important to carefully discern what regulation and principles apply to it. In this section we will first define the meaning of “robot” – including the origins of the word and its legal and also engineering definition. Then we will define *service robots* and describe the main differences with industrial robots. Section 3 defines *personal care robots* – the core of this research; and section 4 identifies robots out of the scope of personal care robots’ definition. Section 5 will include the results of a comparative research between the in- and out-scope categories of ISO 13482:2014.

The word *robot* was introduced in the English vocabulary for first time after the play “R.U.R.” written by Karel Čapek in 1920 was staged in New York in 1922⁵⁷. R.U.R., that stands for “Rossumovi Univerzální Roboti” (Rossum’s Universal Robots), was a factory that produced artificial workers named “roboti”. Roboti were supposed to do the tedious work of humans. They looked human-like and they could think by themselves. Although at the beginning roboti did the human work, they revolted in the end against humans.

⁵¹ Zielinska, T. (2014) History of Service Robots. Information Resources Management Association, dir. Robotics: Concepts, Methodologies, Tools, and Applications. USA, ING. Global.

⁵² See Scott, N. (2001) Ambiguity versus Precision: The Changing Role of Terminology in Conference Diplomacy. In: Kurbalija, J. and Slavik, H. (2001) Language and Diplomacy, p. 153. See also Hoeflich, M. H.: Roman and Civil Law and the Development of Anglo-American Jurisprudence in the Nineteenth Century, University of Georgia Press, pp. 9-30 (1997); and Chapin, F. S.: Definition of Definitions of Concepts. In: Social Forces, Vol. 18, No. 2, pp. 153-160 (1939).

⁵³ See Fetzer, J. H., Schlesinger, G. N. and Shatz, D.: Definitions and Definability Philosophical Perspectives. Synthese Library Studies in Epistemology, Logic, Methodology, and Philosophy of Science, Vol. 216 (1991).

⁵⁴ Oxford Dictionary: www.oxforddictionaries.com/definition/english/definition.

⁵⁵ Italics added. See Minsky, M. (1988). Society of mind. Simon and Schuster. Prologue, p. 17.

⁵⁶ See Robotics 2020 Multi-Annual Roadmap For Robotics in Europe. Call 2 ICT 24 Horizon 2020, SPARC, 2015, p. 287.

⁵⁷ See Čapek, K. (2004). RUR (Rossum's universal robots). Penguin.

With R.U.R., Čapek intended to highlight the dehumanization of workers through the mechanization of human life⁵⁸. Initially, with the aim to find the best word for these mechanized human workers (also artificial workers) Karek called them first “labori”, a word that derived from Latin – labor, -oris. As he found this word too bookish, he asked his brother’s opinion, and he (Josef Čapek) suggested then the word “roboti”. The word roboti derives etymologically speaking from the archaic Czech word “robota” that means forced/serf labor⁵⁹ or from the word “worker” in other Slavic languages, e.g. in Slovak, “robotník”. Karek Čapek liked it and used it for his play. When this was translated into other languages, the word “robot” was incorporated to the English vocabulary.

Although Čapek brothers’ intention was not to define “robots”, because they basically just ushered the word into existence⁶⁰, they embraced the word with a concrete scenario. This was the word to identify mechanized workers with a human appearance⁶¹ created by humans to perform useful tasks for humans⁶². As the play ended in tragedy, this scenario comes often along with the cliché that technology will destroy mankind because of human’s inability to prohibit its misuse too⁶³.

Thanks to Čapek brothers contribution, today Oxford dictionary reads⁶⁴:

Robot /'rəʊbɒt/ Noun

1. A machine capable of carrying out a complex series of actions automatically, especially one programmable by a computer: half of all American robots are making cars or trucks
 - 1.1. (Especially in science fiction) a machine resembling a human being and able to replicate certain human movements and functions automatically: the robot closed the door behind us.
 - 1.2. A person who behaves in a mechanical or unemotional manner: public servants are not expected to be mindless robots

⁵⁸ See Horáková, J., & Kelemen, J. (2003). Čapek, Turing, von Neumann, and the 20th century evolution of the concept of machine. In Proc. Intern. Conf. in Memoriam John von Neumann (pp. 121-135).

⁵⁹ For a very comprehensive explanation of the story of this word, see Horáková, J., & Kelemen, J. (2003). Robots – some cultural roots. In Proc. 4th International Symposium on Computational Intelligence pp. 39-50.

⁶⁰ Jones, R. (2015) Personhood and Social Robotics – A Psychological Consideration, Routledge, p. 53. Some years after the inclusion of the word “robot” into the Oxford Dictionary, K. Čapek wrote a letter to the dictionary Editor stating the fact that he was not the inventor of the word but his brother Josef Čapek, see: blog.oxforddictionaries.com/2012/11/thanksgiving/.

⁶¹ See the definition of android at: www.oxforddictionaries.com/es/definicion/ingles/android. We did not use the reference “cyborg” because the same dictionary defines cyborgs as “fictional or hypothetical person whose physical abilities are extended beyond normal human limitations by mechanical elements built into the body”; nor “humanoid” because although it is said that humanoids are “being[s] resembling a human in its shape” and there are conference on the topic, such as the IEE-RAS International Conference on Humanoid Robots (www.humanoids2016.org); we are not sure if they are “beings” to the fully extend of the word. See in chapter 3 more information.

⁶² Definition of service robot available at ISO 8373:2012 Robots and Robotic Devices – Vocabulary, 2.10. See also the International Federation of Robotics website referring to this term: www.ifr.org/service-robots/.

⁶³ Horáková, J., & Kelemen, J. (2003) op. cit.

⁶⁴ See www.oxforddictionaries.com/definition/english/robot. See also the definition provided by Merriam-Webster dictionary: “a real or imaginary machine that is controlled by a computer and is often made to look like a human or animal; a machine that can do the work of a person and that works automatically or is controlled by a computer”. See www.merriam-webster.com/dictionary/robot.

2. Another term for crawler (in the computing sense).
3. South African A set of automatic traffic lights: waiting at a robot I caught the eye of a young woman

On its side, Merriam-Webster dictionary reads:

Robot/'rəʊbɒt/ Noun

1. a: a machine that looks like a human being and performs various complex acts (as walking or talking) of a human being; also: a similar but fictional machine whose lack of capacity for human emotions is often emphasized
 b: an efficient insensitive person who functions automatically
2. a device that automatically performs complicated often repetitive tasks
3. a mechanism guided by automatic controls

From the above descriptions, a robot is a sub-category of a machine – a machine that can do actions “automatically”, that either in fiction or reality. It looks like a human being or animal, and although it has no human emotions, it can replicate certain human movements and functions⁶⁵.

The industry also believes that a robot can be defined as a machine, “an apparatus using mechanical power and having several parts, each with a definite function and together performing a particular task”⁶⁶; or an “assembly, fitted with or intended to be fitted with a drive system consisting of linked parts or components, at least one of which moves, and which are joined together for a specific application”⁶⁷, that works by itself with no human control. The automaticity on the task performance, i.e. the autonomy in the performance, is understood as the “ability to perform intended tasks based on current state and sensing, without human intervention”⁶⁸ and plays a crucial role not only in the differentiation between robots and machines, but also between robots and robotic devices: robotic devices differ from robots because they are deprived of programmable axes or without autonomy⁶⁹. This also relates to the sense-think-paradigm.

Although Alan Turing himself that can-machines-think concrete question was “too meaningless to deserve discussion”⁷⁰, in 1950 he already believed that at the end of

⁶⁵ The state-of-the-art will reveal however that robots can be fully or partially autonomous; that can be anthropomorphic, zoomorphic or non-biomimetic; that can express emotions and that the replication of human functions is making legal scholars rethink the status of these machines in the legal system.

⁶⁶ See www.oxforddictionaries.com/definition/english/machine.

⁶⁷ See ISO 12100:2010 Safety of Machinery – General Principles for Design – Risk Assessment and Risk Reduction, 3.1. For a more complete definition see also article 2 (a) of the Directive 2006/42/EC of the European Parliament and of the Council of 17 May 2006 on machinery, and amending Directive 95/16/EC (recast) (Text with EEA relevance).

⁶⁸ See ISO 13482:2014 Robots and Robotics Devices – Safety Requirements for Personal Care Robots, section 3.1; and ISO 8373:2012 Robots and Robotic Devices - Vocabulary, section 2.2. For other definitions on autonomy, see also Scheutz, M., & Crowell, C. (2007). The burden of embodied autonomy: Some reflections on the social and ethical implications of autonomous robots. In Workshop on Roboethics at the International Conference on Robotics and Automation, Rome.

⁶⁹ See ISO 8373:2012 Robots and Robotic Devices - Vocabulary for the complete definition: a robotic device is an “actuated mechanism fulfilling the characteristics of an industrial robot or a service robot, but lacking either the number of programmable axes or the degree of autonomy”.

⁷⁰ See Turing, A. M. (1950). Computing machinery and intelligence. *Mind*, 59(236), 433-460.

20th century people could talk about machines thinking without being contradicted⁷¹. Nowadays, and not far away from this vision, robots are considered machines, situated in the world, that sense, think and act⁷². Although it has been argued that a robot does not *think* but rather processes the information and weights potential outcomes⁷³, it is also true that the word “think” cannot be interpreted in its common meaning⁷⁴. In fact, the machine decision-making process normally includes (1) data acquisition, perception through sensors (infrared, radar, stereo vision, optical encoders, etc.) and filtering/fusing information; (2) navigation, localization and decision-making (path planning, obstacle avoidance, machine learning); and (3) locomotion, kinematics and motor control in order to act (in various forms: manipulating or moving)⁷⁵. A robot therefore can sense its environment, has the capacity to process the information, and is organized to act directly upon its environment⁷⁶. *Mobility*, therefore, is an important aspect when defining robots. Consistently, the industry defines a robot as an “actuated mechanism programmable in two or more axes with a degree of autonomy moving within its environment, to perform intended tasks”⁷⁷.

What about Law, how does it define robots? This question was presented at WeRobot 2012, the only existing interdisciplinary conference on the legal and policy questions relating to robots⁷⁸. There is no single clear definition for robots and the answers of the general public tend to be influenced by movies⁷⁹. Based on this, and because robots can move around their world and affect it, behave intelligently and are constructed by humans, Richards and Smart answer the question with a working definition:

A robot is a constructed system that displays both physical and mental agency but is not alive in the biological sense.

The ascription of agency is somehow related to the Turing test, i.e. subjective to the external observer. This excludes wholly software-based artificial intelligences that exert no agency in the physical world. This definition was highly discussed in the study

⁷¹ That is why today the dictionary Merriam-Webster defines “thinking-machine” as a: computer. See www.merriam-webster.com/dictionary/thinking-machine.

⁷² Bekey, G. (2012). Current trends in robotics: technology and ethics. *Robot ethics: the ethical and social implications of robotics*. MIT Press, Cambridge, 17-34. Later on we will discuss the embodiment in the current definitions of “robot” provided by the legal community.

⁷³ See Lutz, C., and Tamò, A. (2015). RoboCode-Ethicists: Privacy-friendly robots, an ethical responsibility of engineers?. In *Proceedings of the 2015 ACM SIGCOMM Workshop on Ethics in Networked Systems Research* pp. 27-28.

⁷⁴ Alan Turing already stated at the beginning of his paper in 1950 that if the meaning of words machine and think had to be described as how they were commonly understood, it would be difficult answer his question (Can machines think?) in a different manner than conducting a statistical survey. Similarly, here we cannot understand “think” in its *stricto sensu*.

⁷⁵ See the presentation of Klier, J. (2010) LabVIEW Robotics: Sense-Think-Act – Application Engineers National Instruments at the NIDays Conference, available at: www.slideshare.net/mayankagarwal51/labview-robotics-sensethinkact.

⁷⁶ See Calo, R. (2015) *Robotics and the Lessons of Cyberlaw*. 103 *California Law Review*.

⁷⁷ ISO 8373:2012 op. cit.

⁷⁸ See the paper submitted at WeRobot Conference 2012 in Miami: robots.law.miami.edu/wp-content/uploads/2012/03/RichardsSmart_HowShouldTheLawThink.pdf. For the latest version of the article, see: Richards N. M. and Smart, W. D. (2016) *How Should the Law Think about Robots?* In: Calo, R. et al. (2016) *Robot Law*, Edward Elgar Publishing, pp. 3-22.

⁷⁹ The authors include most of legal scholars in the “general public” reference, which is true because worrying about robots from a legal perspective is quite recent issue. For jurisprudence concerning law and robotics prior to this, please look: Calo, R. (2016). *Robots in American Law*. University of Washington School of Law Research Paper, available at papers.ssrn.com/sol3/papers.cfm?abstract_id=2737598.

group on Law and Regulation of Emerging Robotics and Automation Technology at the Berkman Center for Internet and Society at Harvard University in March 2016⁸⁰. Some argued that the definition was human-centered and that it relied on the human-operator. Others, on the contrary, claimed that relying on the human operator could be tricky when this human operator is underage, elderly or cognitively impaired. Some argued that a mind could not be attributed to the robot and that it should be defined “mental agency” at risk to exclude industrial robots. The word “agency” was also discussed because “agents” are very differently defined in both the legal and the engineering domain. For engineers, an agent normally refers to a component of software and/or hardware, which is capable of acting exactly in order to accomplish tasks on behalf of its user⁸¹. In the legal domain an agent could be defined, in a very simplistic way, as “someone or something that acts or exerts power”⁸². The definition excludes software agents as if the embodiment of the robot (its hardware component) were a key aspect on the definition of robots.

The definition given by Richards and Smart somehow remembers what Joseph Engelberger said once: “I can’t define a robot but I know when I see one”. The “I know when I see it” is a colloquial expression that became famous in the *Jacobellis v. Ohio* case in 1964⁸³, and it refers to the expression used when one wants to categorize something but it lacks concrete and defined parameters. The key question to solve in this regard is whether robots are agents regardless of displaying “agency” and, accordingly, what kind of legal status they should be granted.

Another remark comes with the exclusion of software agents. Nowadays there are other types of agents that, despite sensing, thinking, and acting, do not “move”. They are the so-called *softbots*. The word softbot comes from the combination of “software” and “robot”. It identifies a computer program that acts on behalf of a user or another program. The company softbotlab defines it as “an intelligent agent; an autonomous software application that continually carries out tasks on behalf of users. Softbots learn and use acquired knowledge to achieve goals and they get smarter as they gain experience”⁸⁴. Nwana highlights, however, that mobility is not a necessary nor sufficient condition for agenthood and that an agent is an umbrella term that involves a spectrum of different agents. Our impression is that we will have to pay particular attention to algorithms behind softbots and robots.

Although in the judiciary there are several references to the word *robot*, as Calo mentioned⁸⁵, we will close this section with the only definition within a (even if soft) legislation, given by the International Federation of Robotics and ISO. In terms of ISO 13482:2014, a *robot* is an “actuated mechanism programmable in two or more axes with a degree of autonomy⁸⁶ moving within its environment, to perform intended tasks”. This definition was taken and modified in ISO 8373:2012. Another definition comes also with the standard *robotic device*: “actuated mechanism fulfilling the

⁸⁰ The course was held by the visiting professor Kenneth Anderson (hls.harvard.edu/faculty/directory/10020/Anderson) during 4 weeks between March and April 2016. See: cyber.law.harvard.edu/getinvolved/studygroups/robots

⁸¹ See Nwana, H. S. (1996). Software agents: An overview. *Knowledge Engineering Review*, 11(03), Cambridge University Press, pp. 1-40.

⁸² See dictionary.findlaw.com/definition/agent.html

⁸³ See *Jacobellis v. Ohio*, 378, US 184 (2964)

⁸⁴ SoftbotLabs is an intelligent agent and artificial intelligence research and development company. See www.softbotlabs.com/Home/FAQ.

⁸⁵ Calo, R. (2016) op. cit.

⁸⁶ Autonomy is also described in the same *corpus* (see ISO 13482:2014, section 3.1). It is established that *autonomy* is the ‘ability to perform intended tasks based on current state and sensing, without human intervention’. Vid. also ISO 8373:2012 Robots and Robotic Devices - Vocabulary, section 2.2.

characteristics of an industrial robot or a service robot, but lacking either the number of programmable axes or the degree of autonomy”. It is important to know that difference: robotic devices differ from robots because they are deprived of programmable axes or have no autonomy.

No matter what definition we give to robots at this stage, the European Parliament has postponed the matter of finding a definition for robot in the legal domain. Yet, the European Parliament focuses on finding a definition to “smart robots”, although the concept of “smart” was not included in any of the above-mentioned initiatives and was later on criticized by the next report of the European Parliament in October 2016⁸⁷. Moreover, the European Parliament has not taken the challenge to define robots directly, but they have outlined the essential parts that the European Commission should consider when producing this definition⁸⁸:

- The capacity to acquire autonomy through sensors and/or by exchanging data with its environment (inter-connectivity) and the analysis of those data
- The capacity to learn through experience and interaction
- The form of the robot’s physical support
- The capacity to adapt its behaviors and actions to its environment

It seems therefore that the European Parliament wants to focus in the embodiment of robots as well. The second report pushes for the nomenclature *autonomous robot* although it admits that this would clash with those tele-operated robots such as DaVinci surgeon robot or some drones. That is why Bertolini and Palmerini suggested a very recent and complex definition⁸⁹:

a machine, which (i) may be either provided of a physical body, allowing it to interact with the external world, or rather have an intangible nature - such as a software or program -, (ii) which in its functioning is alternatively directly controlled or simply supervised by a human being, or may even act autonomously in order to (iii) perform tasks, which present different degrees of complexity (repetitive or not) and may entail the adoption of not predetermined choices among possible alternatives, yet aimed at attaining a result or provide information for further judgment, as so determined by its user, creator or programmer, (iv) including but not limited to the modification of the external environment, and which in so doing may (v) interact and cooperate with humans in various forms and degrees

⁸⁷ See The European Parliament’s Committee on Legal Affairs, Policy Department for “Citizens’ Rights and Constitutional Affairs Study on European Civil Law Rules in Robotics of October 2016 available at: [www.europarl.europa.eu/RegData/etudes/STUD/2016/571379/IPOL_STU\(2016\)571379_EN.pdf](http://www.europarl.europa.eu/RegData/etudes/STUD/2016/571379/IPOL_STU(2016)571379_EN.pdf)

⁸⁸ 2015/2103(INL) European Parliament Resolution on Civil Law Rules on Robotics (May, 2016).

⁸⁹ Bertolini, A. and Palmerini, E. (2014) Regulating Robotics: A Challenge for Europe. European Union. Available at:

[www.europarl.europa.eu/RegData/etudes/IDAN/2014/509987/IPOL_IDA\(2014\)509987\(ANN01\)_EN.pdf](http://www.europarl.europa.eu/RegData/etudes/IDAN/2014/509987/IPOL_IDA(2014)509987(ANN01)_EN.pdf)

As what this thesis concerns, this latest definition might be what defines best what is a *robot* – although our focus is on personal care robots. Inspired by Engelberger, Smart, and the definitions given above, “a robot is a robot” might be the simplest statement that could refer to what is a robot, meaning that definitions change over time and are clearly time and context dependent. Although we set as a starting point this definition, in order to frame our discussion for personal care robots we will introduce a more functional and contextual definition including capabilities and characteristics of the robots in question. A technical classification based on these capabilities will be presented.

2. Personal Care Robot as Service Robot

Apart from these general definitions of robots, robots can be categorized into sub-classes, such industrial or service robots. Service robots are meant for serviceable contexts, monitored autonomously (or with a degree of supervision), and *perform useful tasks for humans excluding industrial automation application*, as stated in section 3.4 of ISO 13482:2014. This is inspired by ISO 8373:2012. According to the International Federation of Robotics (IFR), a robot is classified as industrial robot or service robot depending on its intended application⁹⁰.

INDUSTRIAL ROBOTICS		SERVICE ROBOTICS
Expert Usage: trained users needed		Aiming non-Expert Usage: Market Value
Well-Defined Tasks in Well-Defined Environments		Multi-task Robots in non very Well-Defined Environments (Autonomy)
HRI as less as possible (avoiding hazards)		High-level of HRI (addressing hazards)

Figure 4 Shift from Industrial Robotics to Service Robotics. Main features.

As we can see in Figure 3⁹¹, until now robots were conceived to perform precise tasks, in already-defined environments, with a minimum of Human-Robot Interaction (HRI), and aiming to avoid any harm to humans. Industrial robots were in fact the first to be defined by organisms like ISO, because they were introduced quickly in the assembly lines of the industries⁹². The raising societal challenges nevertheless called in for robots that could perform several tasks and services for and with people. This close contact with the human is what has raised new legal challenges.

The IFR distinguishes between personal and professional service robots depending on their use. Service robots for personal use are those not used for commercial tasks and usually operated by people without professional or specialized robotic knowledge. Some examples according to IFR are domestic servant robot, automated wheelchair,

⁹⁰ See <http://www.ifr.org/service-robots/>

⁹¹ See Cerqui, D.; Kai O.: Human Beings and Robots: Towards a Symbiosis? A 2000 People Survey. In: Carrasquero, J. and al. (eds) Post-Conference Proceedings Politics and Information Systems: Technologies and Applications. PISTA 03, pp. 408-413 (2001).

⁹² Industrial robot can be defined as an ‘automatically controlled, reprogrammable multipurpose manipulator, programmable in three or more axes, which can be either fixed in place or mobile for use in industrial automation applications [...] includes: the manipulator, including the actuators; and the controller including teach pendant and any communication interface (hardware and software)’. Vid. ISO 10218:2011, section 3.10 (inspired by ISO 8373:1994, definition 2.6).

personal mobility assist robot, and pet exercising robot – which seem to be in line with “personal care robots” better discussed in further chapters⁹³.

Service robots for professional use are used for commercial tasks, usually operated by a trained operator who is entitled to start, monitor and stop the task of the robot. Examples include cleaning robot for public places, delivery robot in offices or hospitals, fire-fighting robot, rehabilitation robot and surgery robot in hospitals.

We will not analyze all service robots, but only those within the healthcare domain. The European Commission’s Robotics for Healthcare Roadmap defines this domain as “the domain of systems able to perform coordinated mechatronic actions (force or movement exertions) on the basis of processing of information acquired through sensor technology, with the aim to support the functioning of impaired individuals, medical interventions, care and rehabilitation of patients and also to support individuals in prevention programs”⁹⁴. From the six areas of innovation normally related to this healthcare domain – robotics for medical intervention, supporting professional care, preventive therapies and diagnosis, assistive technology and rehabilitation treatment – we will focus on assistive technology⁹⁵.

The assistive technology we will be referring in this work will be personal care robots. Care robots have been defined in the literature as those robots designed for use in home, hospital, or other settings to assist in, support, or provide care for the sick, disabled, young, elderly or otherwise vulnerable persons⁹⁶, or in the care of persons in general⁹⁷. In 2014, a technical standard ISO 13482:2014 was released and provided a definition: “service robots that perform actions contributing directly towards improvement in the quality of life of humans, excluding medical applications”. This definition, taken and modified from ISO 8373:2012, is of value to comprehend the difference between service and industrial robots and to know exactly the scope of our research. No precise characterization is provided further by that ISO, which simply states that the definition of personal care robots will be updated with new guidelines in the future for concrete users as children, elderly persons and pregnant women⁹⁸.

The environments where this kind of service robots will perform will vary enormously: they can be used in institutions that provide services for health care such as hospitals, clinics, nursing homes, assisted living, long-term care facilities, etc.; but they can also be the homes of disabled or elderly patients that have included these service robots to further improve their quality of living. Other places where we will see the more and more this type of robots will be the streets (especially if they have transportation capabilities) or gyms for training (not for rehabilitation) among others.

⁹³ Albo-Canals, J. (2015) Toy Robot versus Medical Device. Newfriends Conference on Social Robots in Therapy and Education. Almere, The Netherlands.

⁹⁴ See Butter, M. et al. (2008) Robotics for Healthcare. Available at: https://ec.europa.eu/eip/ageing/library/robotics-healthcare_en

⁹⁵ See http://www.foresight-platform.eu/wp-content/uploads/2011/02/EFMN-Brief-No.-157_Robotics-for-Healthcare.pdf

⁹⁶ Vallor, S. (2011) Carebots and caregivers: Sustaining the ethical ideal of care in the 21st century. *Journal of Philosophy and Technology*, 24, pp. 251–268

⁹⁷ Van Wynsberghe, A. (2013). Designing robots for care: Care centered value-sensitive design. *Science and engineering ethics*, 19(2), 407–433

⁹⁸ See last paragraph of the introduction of ISO 13482:2014.

3. Types of Personal Care Robot

Up to now, ISO 13482:2014 is the only instrument to provide a definition of personal care robots. According to it, personal care robots are “service robots that perform actions contributing directly towards improvement in the quality of life of humans, excluding medical applications”⁹⁹. And it “might include physical contact with the human to perform the task”. This ISO also provides some typical examples of personal care robots, including mobile servant robots, physical assistant robots and person carrier robots (*see* below).

This definition might lead to confusion however, especially because *personal care* is not defined in the ISO. Vagueness in technical definitions leads to misunderstanding in legal terms, and thus to unforeseeable legal scenarios: one may be compliant with wrong instruments (e.g. not medical device legislation) and, for that reason, be exposed to sanctions and further responsibilities and – most importantly – put users in risky or harmful situations.

Collins dictionary defines personal care as the “help given to elderly or infirm people with essential everyday activities such as washing, dressing and meals”. Elderly Accommodation Counsel of the UK (EAC) sustains that it is the “assistance with dressing, feeding, washing and toileting, as well as advice, encouragement and emotional and psychological support”¹⁰⁰. EAC adds that ‘the Department of Work and Pensions of the UK (DWP) defines this as attention required in connection with bodily functions. Bodily functions can include dressing, washing, bathing or shaving, toileting, getting in or out of bed, eating, drinking, taking medication, [and] communicating. Seeing and hearing are also considered to be bodily functions”.

The definition of personal care is somehow related with the Instrumental Activities of Daily Living¹⁰¹, something that seems to have nothing to do with medical activities. Robots described as personal care robots (mobile servant robot, physical assistant robot and person carrier robot), however, do not still comply with all these functions, and this is a major issue. Actually, the state of the art is a bit behind. For instance, mobile servant robot is defined as a robot that handles objects and exchange information, but nothing is said regarding other uses like helping users with dressing or feeding. Another example is Resyone of Panasonic, the first robot that obtained the ISO 13482:2014 certification. This is a robotic bed that transforms into a reclining wheelchair. It is true that it can help patients to get in or out of bed, and that is considered part of personal care, but it still does not perform any of the main actions within the range of personal care activities¹⁰².

Roboticists, standard bodies and policymakers need to be acquainted with the importance of defining the type of robot they are creating concretely and unequivocally. To do this, not only the characteristics of the robot will be important, but also how the end users will use it. For instance, if an exoskeleton was born to be a physical assistant robot, personal care robot ISO will apply; however, if the same exoskeleton is used for rehabilitation purposes, then the applying ISO would be the one regarding medical devices because rehabilitation falls under that specific ISO (and also the European directive 93/42/EEC on medical devices, or Directive 90/385/EEC

⁹⁹ ISO 13482:2014 “Robots and Robotics Devices – Safety Requirements for Personal Care Robots”, 3.13.

¹⁰⁰ For more information *see* <http://www.housingcare.org/jargon-personal-care-ea2e2.aspx>

¹⁰¹ Lawton, M.P. and Brody, E.M.: Assessment of older people: Self-maintaining and instrumental activities of daily living. *The Gerontologist*, 9(3), pp. 179-186. (1969)

¹⁰² We will talk about this robot further on the thesis.

on active implantable medical devices, especially now that the future regulation of medical devices will extend its scope to these devices, *see* following chapter).

3.1 Person Carrier Robot

Person carrier robots are defined as:

Personal care robot with the purpose of transporting humans to an intended destination.

Person carrier robots are the third type of robots mentioned by ISO in section 3.16. They are meant to convey persons from one place to another one, sometimes including also pets and personal belongings. The standard also foresees the possibility that the carriers incorporate a cabin and equipped with a seat and/or standing support. Section 6.1.2.3. distinguishes between two basic kinds of person carrier robots:

- a) Type 3.1. (which redirects to the “autonomy” section¹⁰³): person carrier where a single passenger will be standing, the task will be performed in indoor flat surfaces, and it is going to be lightweight¹⁰⁴, slow¹⁰⁵ and statically stable¹⁰⁶. Segways®, for instance, belong to this type of person carriers.
- b) Type 3.2. (which redirects to “robot”¹⁰⁷): person carrier that can convey multiple or non-standing passengers in outdoor environments, in uneven surfaces and it is not lightweight, slow or autonomous. Cybercars such as the vehicles in Masdar city or the Serpentine project could be included into this category¹⁰⁸.

ISO 13482:2014 aims to embrace personal care robots and addresses their related hazards. Self-driving cars have their own specific hazards¹⁰⁹: speed limit, traffic-security related issues, acceptance from other drivers, moral algorithms¹¹⁰, liability in case of accident, fitting in smart cities, pollution and other environmental issues like

¹⁰³ Autonomy, as described by the ISO 13482:2014, is “the ability to perform intended tasks based on current state of sensing, without human intervention”, 3.1. (taken from ISO 8373:2012).

¹⁰⁴ Lightweight is defined by ISO 13482:2014 section 6.1.2.3. Note 2: “a weight is considered to be “lightweight” if it is sufficiently low that injuries other than minor injuries due to impact are unlikely and that a single user can lift the weight to free oneself if being trapped. A maximum weight which can be considered as lightweight is determined by the manufacturer considering intended tasks and user groups”.

¹⁰⁵ Slowness is defined by the same standard in Note 3: “a speed is considered to be “slow” if it is below the normal walking speed of the intended user group as determined by risk assessment. For a healthy adult, walking speed is usually assumed to be up to 6km/hr”.

¹⁰⁶ Static stability is, according to Note 5, when “the stability of the robot is maintained during stand-still without drive power after inherently safe design measures have been applied. Depending on the intended use of the robot, this includes maintaining stability of both the user and the robot when the user is in contact with the robot, e.g. by gripping handles attached to the robot or leaning on the robot”. One comment in the gripping-handle respect goes in connection with unicycles. Unicycles are currently considered person carriers because they meet with this type of robot characteristics. Safety requirements, however, will vary substantially because they are not providing any sort of handles as safety-related control system requirement.

¹⁰⁷ *See* the definition given above.

¹⁰⁸ *See* www.2getthere.eu/projects/masdar-prt/ and www.serpentine.ch/p_systeme/Systeme.html. For more information *see*: www.cybercars.fr.

¹⁰⁹ For more information *see* Kohler, W. J., and Colbert-Taylor, A. (2014). Current Law and Potential Legal Issues Pertaining to Automated, Autonomous and Connected Vehicles. Santa Clara Computer & High Tech. L.J., 31, 99

¹¹⁰ *See* Moral Algorithms: the Ethics of Autonomous Vehicles (2016) at the Center for Ethics and Human Values at the Ohio State University: cehv.osu.edu/events/moral-algorithms-conference Available at: livestream.com/WOSU/MoralAlgorithms

dependency on electricity, or the impact on driving professions such as taxis or truck drivers¹¹¹. Person carrier robots have their own hazards and that is why ISO 13482:2014 individualized them in a specific category.

Apart from the two categories mentioned above, Annex D ISO 13482:2014 adds that person carriers can include 1) Carriers with passenger standing on the foothold; 2) Legged passenger carriers; 3) Carriers where passenger sits on a monocycle; and 4) Wheeled passenger carriers. Here their descriptions:

- Carriers with passenger standing on the foothold (Fig. 5)¹¹². The most typical example are segways®. They are conveyors intended to travel on smooth surfaces using wheeled mobile platforms. The travel direction is controlled by shifting the passenger's weight on the base foothold.

The DOMEO Project was a project that aimed at inserting assistant robots in homes and it was conducted within the European active and assisted (FP7)¹¹³. Some of the researchers conducted a risk assessment on different types of person carriers and stated that these conveyors were to transport people throughout domestic properties at a slow speed appropriate to moving about the house¹¹⁴. Nevertheless, the state of the art reveals that segways are practically only used in outdoor contexts: people use them to go to work, do sightseeing tours in cities¹¹⁵ or outdoor activities. Indeed, there is no great evidence that segways are used in indoor contexts even if some research suggest that it could be possible¹¹⁶.



Figure 5 Segway x2 SE. Source: www.segway.com/products/consumer-lifestyle/segway-x2-se

¹¹¹ See Vanstone, L. (2016) In the driverless future, what happens to drivers' jobs? Houston Chronicle. Available at: www.houstonchronicle.com/local/gray-matters/article/In-the-driverless-future-what-happens-to-6756797.php. For the latest example of a self-driving truck, see Petersen, A. (2016) The driverless car is coming, and it's going to automate millions of jobs. Crunch Network, available at: techcrunch.com/2016/04/25/the-driverless-truck-is-coming-and-its-going-to-automate-millions-of-jobs/ Also Berman, D. K. (2013) Daddy, What Was A Truck Driver? - Over the Next Two Decades, the Machines Themselves Will Take Over the Driving. The Wall Street Journal, available at: www.wsj.com/articles/SB10001424127887324144304578624221804774116.

¹¹² Fig. 4

¹¹³ See www.aal-domeo.org and www.aal-europe.eu

¹¹⁴ Toth A. DOMEO Project. AAL-2008-1-159. ID: R-BME-1_0-D4.3 D4.3 Risk Assessment/ISO Links.

¹¹⁵ There are a lot of touristic companies that offer this service. To enumerate a few: www.barcelonasegwaytour.com/en/; www.lithuaniantours.com/en/travelers/special-offers/135-vilnius-segway-tour-package; www.stadtmeister-touren.de/segwaytouren-hannover.php; www.viator.com/tours/Bologna/Bologna-Segway-Tour/d791-5620BOLOGNASEGWAY; or www.powertours.it/eng/Turin-Segway-Tours.html

¹¹⁶ See Jarvis, R. (2004). A 'Do-it-Yourself' Segway Mobile Robot Platform. In *Proc. Australasian Conf. Robotics & Automation*.

- Legged passenger carriers. ISO defined this kind of robots as robotic bearers conceived to go around 3D surfaces using legged instead of wheeled mobile platforms. These could be used in non-urban locations at the speed of a walker. In May 2016, Google search engine did not provide any relevant search on these kind of robots. Toyota released i-Foot in 2004 but never entered the market¹¹⁷. One could think of LS3 robot from Boston dynamics as an example of legged passenger carrier¹¹⁸; however, LS3 is a legged squad support system that helps marines and soldiers carry their load, not to convey them from one place to another.



Figure 6 i-Foot Toyota Model Source: www.toyota-global.com/innovation/partner_robot/aichi_expo_2005/index03.html

- Carriers whose passenger sits on a



7 U3-X Honda Source: world.honda.com/U3-X/

monocycle. These person carriers are similar to segways. One of the most known examples is the Toyota U3-X model¹¹⁹. Their particularity is that the person is sitting down instead of standing as it happens with some of the segways. The traveling direction is controlled by the shift of the passenger's weight through balancing.

In the DOME0 Project, Toth argued that these carriers were for large indoor public spaces such as airport terminals, large exhibition centers or shopping malls. At the moment these devices have not entered the market. Some of the companies, such as Honda or Hyundai with its model E4U¹²⁰ only release these models as prototypes in fairs but they have no actual intention of selling them.

- Wheeled passenger carriers. ISO 13482:2014 defines them as person carriers that “physically transport a person from one destination to another on smooth surfaces, with either autonomous mode or manual mode using a wheeled mobile platform”. Robots like the Toyota i-Real could be considered wheeled passenger robots. The ISO TC 184/SC 2/WG 7 decided to avoid the use of the word “wheelchair” because it could lead to confuse these devices with wheelchairs, which are in theory medical devices.

¹¹⁷ See www.toyota.co.jp/en/news/04/1203_1d.html

¹¹⁸ See www.bostondynamics.com/robot_ls3.html

¹¹⁹ See world.honda.com/U3-X/

¹²⁰ See www.huffingtonpost.co.uk/2013/04/02/hyundai-e4u-egg-shaped-car-future_n_2998225.html

Manual wheelchairs are medical devices class I, motorized wheelchairs are class II and stair-climbing stairs are class III. Robotic wheelchairs are not considered medical device (either by the FDA or the EU) nor have a recognized official category. Terminology is still developing and currently it is not consistent across research and regulatory stakeholders¹²¹. In fact, the International Federation of Robotics defines personal service robot or a service robot for personal use (which ISO identifies as “personal care robots”) as follows: “a service robot used for a non-commercial task, usually by lay persons. Examples are domestic servant robot, automated wheelchair, personal mobility assist robot, and pet exercising robot”¹²². In fact, Dinwiddie in a very recent book about “Basic Robotics” introduces the new ISO 13482:2014 on personal care robots, and states “Personal carrier robots are devices that take people from point A to point B. Robotic wheelchairs and self-driving vehicles fall into this sub-category”¹²³.



en.wikipedia.org/wiki/Toyota_i-REAL

Within all these person carrier categories, we wonder whether “robots that transport humans to an intended destination” should be interpreted widely or restrictively. For instance the aim of RIBA – Robot for Interactive Body Assistance – is to lift up or set down a human from or to a bed or wheelchair (Fig. 6)¹²⁴. Can we then consider RIBA a person carrier robot? In this particular case, the robot is not transporting a human from a destination to another destination, but conveying him from one place to another one, i.e. from the floor to the bed, or from the bed to the wheelchair.

¹²¹ Robotics 2020 Multi-Annual Roadmap. For Robotics in Europe. Call 2 ICT 24 Horizon 2020, SPARC, 2015, p. 287

¹²² See www.ifr.org/service-robots/

¹²³ See Dinwiddie, K. (2015). Basic Robotics. Nelson Education p. 117

¹²⁴ For further information see rtc.nagoya.riken.jp/RIBA/index-e.html.



Figure 9 RIBA Source: tecnocualblog.wordpress.com/2012/02/21/el-robot-ayudante/

If we do not recognize RIBA in this category, what is the regulation for these robots in the lack of any other regulation? Who is entitled to decide which robots that fall within the scope of the regulation? The Standard Organization?

Also, should segways be considered part of this category? Should we have different segway categories, for civil use and in military contexts? Should we differentiate segways intended to be used by elderly care or those used for younger generations? We will be discussing these questions in the following chapters.

3.2 Physical Assistant Robot

Physical assistant robots are defined as follow in ISO 13482:2014:

Personal care robot that physically assists a user to perform required tasks by providing supplementation or augmentation of personal capabilities

User is understood by ISO as *either the operator of the personal care robot or the beneficiary of the service provided by the personal care robot*¹²⁵. Such robots do not *stricto sensu* interact with humans (they do not talk to humans nor they serve them a cup of tea as mobile servants do), but they are directly laced to them. In fact, and according to ISO 13482:2014, this entwinement within this sub-type of personal care robot creates two new sub-categories: restraint and restraint-free physical assistant robots.

- a) Restraint physical assistant robots are *fastened to a human during use*. This would include wearable suits or non-medical physical assistance exoskeletons, that is to say, robots that directly help users by being attached to the humans.

¹²⁵ Here *operator* indicates the person designated to make parameter and program changes, and to start, monitor, and stop the intended operation of the personal care robot. Vid. Section 3.25 ISO 13482:2014.

- b) Restraint-free physical assistant robots, on the contrary, *are not fastened to a human during use*. This could include power assisted devices or powered walking aids¹²⁶.

This ISO differentiates *supplementation* and *augmentation*. Supplementation is the “assistance that restores a normal level of human capability to persons who may otherwise have difficulty in doing so (due to fatigue, handicap, etc.)”¹²⁷. A. Toth argues that this supplementation can, at the same time, be divided into two sub-categories: up-to-50% and 50%-100% categories. Such percentages are linked to the degree of physical assistance needed by a user, and determine whether the robot is physically more powerful than the human user. Augmentation is the “physical assistance to humans to perform physical tasks that exceed what can normally be expected without assistance (e.g. extreme strength, endurance, etc.)”.

As we can imagine, problems and ethics associated with restraint and restraint-free physical assistant robots can be totally different, and so is also the decision-making process regarding the two categories.

Physical assistant robots will track the movements of the patient in order to record, control and monitor how it is used. This tracking is fundamental for the physician or the therapist to know what therapy needs to apply, and to know if there is any improvement in the patient’s disease; but also for the users to better evaluate their progress.

These kind of robots, together with person carriers differ from mobile servant robots because while the first two perform tasks for users¹²⁸, the second helps the user to perform himself the intended task. The particularity of these robots lies also on the fact that persons are impaired, so they may not be capable of walking, manipulating, eating, etc. While mobile servant robots can perform duties for both people with or without disability, physical assistant robots were originally meant specifically for disabled users. This is also what happens with “wheeled passenger carriers”: although they are person carriers and personal care robots, they may also be considered as robotic wheelchairs that help infirmed people.



Because of their aim, physical assistant robots can be of many different typologies. The biggest distinction is between 1) upper limbs and 2) lower limbs, depending on what are the limbs that the device is going to provide assistance with. Annex D.2 in ISO 13282:2014 is more precise and gives some examples summarized in this chart:

CLASS	FUNCTIONAL TASKS	EXAMPLES
-------	------------------	----------

¹²⁶ Vid. 3.15.1 and 3.15.2 in ISO 13582:2014. As a powered walking aid we have to mention i-Walker, a robotic walking aid we visited in Universitat Politècnica de Catalunya included in the project Long Lasting Memories – Mind and Body Fitness for Live (LLM). The topic addressed inside ICT-PSP Program it was 14: ICT for ageing well with cognitive problems, combining assistive and independent living technologies (2008).

¹²⁷ Extracted from the DOME0 project. AAL-2008-1-159, and its id is: R-BME-1_0-D4.3 D4.3 Risk Assessment/ISO Links. Author: Andras Toth.

¹²⁸ Someone argued that we are going through the new way of slavery. See Blanco, R. (2013) Robots: Slavery in the Digital Age www.dailyreckoning.com.au/robots-slavery-in-the-digital-age/2013/11/08/.

<p>Leg Motion Assistant Robot</p>	<p>Applying cooperative control to user's thighs in order to control the stride and to achieve comfortable walking.</p> <p>Honda released the walking assist device (here on the right) in order to support people with weakened leg muscles to walk in 2015. More information can be found in: world.honda.com/Walking-Assist/.</p>	
<p>Body Weight Supportive Device</p>	<p>Reducing the load on leg, hip, knees, and ankles while standing or walking by supporting part of the user's bodyweight.</p> <p>Hokoma introduced “Andago” (here on the right) that is a body weight supported gait training with unparalleled mobility. They prepared the V 2.0. and introduced in 2015 after the great success of Lokomat in 2013 and offers physiological training and a confidence in walking in a plug-in way. More information at www.hocoma.com/fileadmin/user/Dokumente/Andago/fly_Andago_160121_en_USA_04.pdf</p>	
<p>Exoskeleton Wearable Robot</p>	<p>Physically supporting a human and manipulating body parts through direct interaction and fixtures to a person, e.g. straps or clams. Enabling the user to carry loads similar to or above average human strength.</p> <p>WALKI is an actuated lower limb orthosis for short-sized individuals or children who survived to a spinal cord injury (SCI). It is a project from École Polytechnique Fédérale de Lausanne, EPFL in Switzerland (here on the right). The role of this exoskeleton is to mobilize the legs of SCI individuals, who have sensory-motor impairments, and allow them to walk again. The hip and at the knee of each leg are actuated by electrical motors in a walking pattern. The users manage to keep his/her balance with the help of crutches.</p>	



<p>Wearable Robot</p>	<p>Providing fixture directly to a human without invasion, e.g. straps and clamps to provide direct interaction for dexterous manipulation. Enabling the user to carry loads similar to that of an able bodied person.</p> <p>The picture on the right is extracted from ISO 13482:2014. We decided to put the example given in the standard because it is a robot that has not hit largely the market yet. More information in Annex D.2.</p>	
<p>Restraint-free Assistance Robot</p>	<p>To assist elderly/tired person to and from a chair, bed, etc. To assist in basic mobility tasks on flat ground with or without help from partner. To help provide more ease and comfort in daily life for independent living.</p> <p>Here on the right we can see Ulises Cortés, de IP of the Project at UPC in Barcelona with its i-Walker, an intelligent pedestrian mobility aid that was developed under the project Supported Human Autonomy for Recovery and Enhancement of Cognitive and Motor Abilities Using Information Technologies ¹²⁹ . More information at kemlg.upc.edu/en/projects/i-walker/laboranova</p> <p>There are other robotic devices instead that even if they assist elderly to and from a chair (as we can see in the restraint-free assistance robot); they have been considered as mobile servant robots by the committee of ISO. This is the case of the Panasonic device Resyone¹³⁰. We will talk about this in chapter 4.</p>	

Table 1 See D.2. of ISO 13482:2014 plus examples of Physical Assistant Robots

There are as many physical assistant robots as physical disabilities. Tristan Vouga, from EPFL, sustained that there are too many exoskeletons, and the research on them has not progressed a lot during the recent years. This issue was also stressed by Tim Swift in 2015, who said that due to the expensive cost of the technology, it would take decades to make an improvement¹³¹. This was confirmed by the Exoskeleton Report

¹²⁹ The project is available at: <https://kemlg.upc.edu/en/projects/past-projects/share-it-1/share-it>. You can find an explanatory video at www.youtube.com/watch?v=sCTOvM0pl48

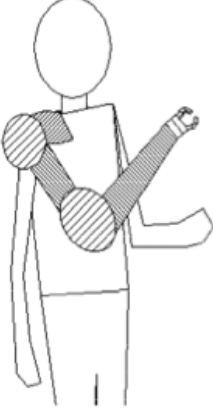
¹³⁰ There is an ongoing discussion about this topic.

¹³¹ See <http://exoskeletonreport.com/2015/10/otherlab-orthotics-a-fundamental-jump-in-technology/>



Figure 10 Kuratas being developed by suidobashijuko.jp

of 2016¹³². This highly affects a future policy governing this technology: how general should a regulation be so as to include all the different exoskeletons available in the market? As regulations are static, regulations are never going to be able to catch up with this technological revolution and this variety of devices. On the contrary, a dynamic regulation with a bottom-up perspective (see chapter 2) could avoid over-/under- regulated scenarios. This kind of regulation would come from the device itself. Moreover, if a technology is not yet on the market, is a regulation needed anyway? Would that be a barrier to

the insertion of this technology? Or would it promote the creation of a pro-active legislation at last?

Interaction with users is very high with this type of robots. Physical Assistant Robots become part of the user, because without them, the user cannot perform the intended tasks. In some cases, Physical Assistant Robots help the user to ameliorate their capacities; other times, they work without improving the patients' state¹³³.

Of note, the use of the robot cannot determine the regulation under which it falls and the requirements that a robot should have in order to be compliant for a particular category. Yet, different regulations may apply to the same robot, and producers would have to provide different kinds of the same device to comply with such categories. Large companies have realized that personalization is the key factor for business success, and they not only have started to provide different exoskeletons for different uses (for personal care and for medical device)¹³⁴, but they are also providing exoskeletons with different sizes, and even exoskeletons that are fully personalized to the users' body¹³⁵

There will be several questions to address, most of them related to whether these devices can be considered part of the human body and the value they have in terms of insurance¹³⁶.

The concept of super-humans associated to all this technology is also a matter of discussion. These robots in fact increase the power of the human. This was discussed

¹³² See the report of August 2016 at: exoskeletonreport.com/2016/08/exoskeleton-industry-2016/

¹³³ Exoskeletons do not still cure disabilities. Exoskeletons are conceived to boost strength and endurance of the wearer. And even it has been mainly used for military reasons; nowadays the exoskeleton research is focusing on helping paraplegic people among other users. In MESROB 2014 Solaiman Shokur presented a brain-controlled exoskeleton. Brain-Computer interface is on fashion and the more and more we will have devices brain controlled; and that will lead us to some ethical questions.

¹³⁴ For instance, Cyberdyne is doing this. See www.cyberdyne.jp

¹³⁵ We will see also this in chapter 3B, with the project EXOLEGS.

¹³⁶ See Section 418.361 of the worker's disability compensation act from 1969 in Michigan: Effect of imprisonment or commission of crime; scheduled disabilities; meaning of total and permanent disability; limitations; payment for loss of second member. Available at: [www.legislature.mi.gov/\(S\(sp4z0qqaruxh0o3l3ygvw4wr\)\)/mleg.aspx?page=GetObject&objectname=mcl-418-361](http://www.legislature.mi.gov/(S(sp4z0qqaruxh0o3l3ygvw4wr))/mleg.aspx?page=GetObject&objectname=mcl-418-361)

by CCN in 2013¹³⁷. The main question is whether we will see the development of these wearable suits in a destructive way; for instance, if they are going to end up being “Kuratas”¹³⁸. The Japanese company called Suidobashi Heavy Industry has developed Kuratas¹³⁹ (see Fig. 9). Kuratas are wearable robots that resemble killer machines because they incorporate several guns within the system, some of them are a twin gatling gun that can unleash 6000 BB bullets a minute.

To avoid unfortunate scenarios, it is important to discuss and clarify the role of wearable robots and whether this is what we want for society.

3.3 Mobile Servant Robot

ISO 13482:2014 defines mobile servant robots as follows:

Personal care robot that is capable of travelling to perform serving tasks in interaction with humans, such as handling objects or exchanging information.

First, we need to remember that ISO identifies personal care robot as service robots; and industrial applications are excluded in that definition (in fact, they are excluded expressly from its corpus). Service robots, as we have already seen, *perform(s) useful tasks for humans*. Oxford dictionary defines “service” as *the action of helping or doing work for someone*. That is the core distinction within industrial and service robots, but also between person carrier/physical assistants and mobile servant robots (they help users perform a task).

In that definition, task means a piece of work to be done. This is significant because the word task does not appear in the general definition of personal care robot, an important precision if we further want to include other kinds of robots inside this general category.

Second, it is capable of traveling. This capacity is connected with the degree of autonomy of the robot, that is, the ability to perform intended tasks based on current state and sensing, without human intervention¹⁴⁰. By reading the Terms and Definitions of ISO 13482:2014, one can realize that there is the intention to stress that mobile servant robots are robots that work in autonomous mode. Nonetheless, we cannot conclude that mobile servant robots only work in autonomous mode, because that depends on the intentionality of the creator and the way it performs the assigned tasks. Sometimes, a robot will be operated by a human teleoperator, the physician for instance.

¹³⁷ Ponsford, M. (2013) Robot exoskeleton suits that could make us superhuman. For CNN. See www.cnn.com/2013/05/22/tech/innovation/exoskeleton-robot-suit/. Other news on the topic at: www.engadget.com/2014/08/04/daewoo-robotic-exoskeletons/ and This one from Harvard University www.sciencealert.com/new-wearable-robotic-exoskeleton-gives-you-superhuman-powers.

¹³⁸ See a quick news in www.ibtimes.co.uk/kuratas-giant-wearable-mecha-robot-suit-currently-sale-amazon-japan-1m-1484125.

¹³⁹ See suidobashijuko.jp. If you have time, it is worth watching this video explaining how to ride kuratas: <https://www.youtube.com/watch?v=2iZ0WuNvHr8>.

¹⁴⁰ In concrete, there are three modes the robot can work on according to ISO 13482:2014:

1. Manual mode: operational mode in which the robot is operated by direct human intervention via, for example, pushbuttons or a joystick.
2. Autonomous mode: operational mode in which the robot function accomplishes its assigned mission without direct human intervention.
3. Semi-Autonomous mode: operational mode in which the robot function accomplishes its mission with partial human intervention.

These robots can travel in domestic environments or public buildings while avoiding collisions with stationary and moving safety-related obstacles¹⁴¹. This characteristic of traveling might exclude all those helpers and companion robots that do not perform tasks for the users traveling, but that might be helpers standing in a fixed position (with other mobile parts, like the body of the robot as JIBO does)¹⁴².

Third, it interacts with humans. The interaction between humans and machines is very recent; other types of robots like industrial ones did not enjoy that. In fact, the main idea was to avoid that interaction to circumvent hazards¹⁴³. Indeed, the HRI was considered a potential source of harm. With service robotics, HRI regains importance as they aim at non-expert usage. As shown in figure 1, service robots are meant to be in serviceable contexts to help any kind of users and addressing the hazards concerning HRI is considered of crucial importance¹⁴⁴.

Interaction most of the times happen on a cognitive level and not only on the physical level. Furthermore, the robot can have an active or passive role, and this depends on its programming or its intended use.

The human interaction seems a condition sine qua non of its definition, and it can be of several types:

1. Verbal: most of the times, the robot will interact verbally with humans.
 - 1.1. Expressly: because the robot is meant to communicate with the users (because it is supposed to exchange information with them).
 - 1.2. Accidentally: asking for permission to cross one corridor, thanking someone for their comments, etc.). In fact, we will increasingly interact with robots as we do with humans.
2. Physical: corporal contact is avoided when designing robots. It is quite obvious: the less contact the robot has with humans, the less the possibilities of harm¹⁴⁵.
 - 2.1. Expressly: robot is meant to touch people. This case is very infrequent. Fisiobot is a robot that touches people to perform some physiotherapy treatment (mainly electrotherapy

¹⁴¹ Definition of safety-related obstacles is found in 3.21.2. and those are *object, obstacle, or ground condition which can cause harm if it comes into contact or collision with the robot*. In our opinion, robot will also have to avoid collisions with safety-related objects in any case if they are not being directed to them (third parties). Safety-related object definition is found in 3.21.1., and those are *human, domestic animal, or property to be protected from harm* (off note that either the properties or the animals to be protected will be different according to the intended use of the Non-Medical Personal Care Robot).

¹⁴² See www.jibo.com

¹⁴³ See Barattini, Paolo, Claire Morand, and Neil M. Robertson. "A proposed gesture set for the control of industrial collaborative robots." *2012 IEEE RO-MAN: The 21st IEEE International Symposium on Robot and Human Interactive Communication*. IEEE, 2012. And Fryman, Jeff, and Björn Matthias. "Safety of industrial robots: From conventional to collaborative applications." *Robotics; Proceedings of ROBOTIK 2012; 7th German Conference on*. VDE, 2012.

¹⁴⁴ In fact, our research is based on the creation of HRI taxonomy to highlight which interactions between humans and machines are relevant in view of the Law. Not all the interactions are going to have the same importance nor the same value; but only with a detailed sorting of interactions we can exactly establish what are the risk scenarios and that way determine the best answer to them.

¹⁴⁵ In Hospital Central de Asturias (HUCA) *manolitos* where going around the hospital without interacting practically with humans: only interacting with the people of the kitchen (that were preparing the trolleys for the rooms with the food) or with the pharmacy (preparing medicines for the rooms). The thing is that the hospital was build expressly though of these robots, so HRI issues was highly addressed (they intended to avoid any human contact by creating special corridors for robots, robot elevators, etc.); problems will arise when will be created a robot that can develop tasks in already-built scenarios where corridors are not wide, where there are no robot elevators, where robots are constantly in contact with humans, etc. By the way, *manolitos* are not considered mobile servant robots but person carrier robots that transport object; something like *object carrier robot*.

treatment, laser intratisue treatment or cupping therapy); nevertheless, Fisiobot is not a mobile servant robot, but a therapy robot.

- 2.2. Accidentally: as one of its main features is traveling, it is normal that sometimes the robot may hit someone. They all have a security bumper and some lasers as a general rule to avoid collision, but sometimes it is just inevitable.
 3. Non-verbal communication: robots will have to be more and more able to understand non-verbal communication. This will be crucial to know when and how to interact. Non-verbal communication can include the use of joystick or any other user interface.
- Fourth, and according to Annex D, it handles small and medium-sized objects like a mug, plate or a book. That action includes grasping, manipulating, transporting, placing and handing over the object. For handling larger objects there might be possible constraints, for instance, opening a door, a window, a drawer or a dishwasher, which might include traveling in order to extend the workspace.
 - Fifth, it exchanges information.. Could a person having impaired hearing feel discriminated because a mobile servant robot is not capable to communicate with him/her? Could the language be a source of misunderstandings among them and can this confusion cause harm? Will the robot be prepared to understand also sign and body language?^{146,147}. Special attention should be drawn to it as access to healthcare is a fundamental right for all¹⁴⁸.

There are already marketable mobile servant robots even if they are not expressly designed for being in Healthcare Institutions. Already existing mobile servant robots are conceived to be able to perform some intended tasks that will vary depending on the buyer/user. For instance in schools as an extra-curricula support, in airports as attendants, or directly in hospitals as helpers/attendants. Nowadays these robots are commonly used just for advertisement purposes rather than as real helpers. In fact, society is not ready for the implementation of these robots yet¹⁴⁹. Nevertheless, people are attracted to robots, they make pictures with them and posts photos on Facebook/Twitter/etc. Interestingly, these robots are capable of making pictures and uploading them directly to twitter and, just to give a quick example, they keep records

¹⁴⁶ See for more information in Reisberg, B., Ferris, S.H., de Leon, M.J., and Crook, T. The global deterioration scale for assessment of primary degenerative dementia. *American Journal of Psychiatry*, 1982, 139: 1136-1139

¹⁴⁷ See Xiao, Y.; Zhang, Z. and Thalmann, D. Human-Robot Interaction by Understanding Upper Body Gesture Understanding. *Proceedings 19th ACM Symposium on Virtual Reality Software and Technology (VRST)*, pages 133-142 (2013)

¹⁴⁸ The access to medicine is backed by the art. 25 Universal Declaration of Human Rights (UDHR), the art. 12 of the International Covenant on Economic, Social and Cultural Rights (ICESCR), the art. 24 of the Convention on the Rights of the Child (CRC), art. 5 of the Convention on the Elimination of all Forms of Racial Discrimination (ICERD), art. 12 and 14 of Convention on the Elimination of All Forms of Discrimination Against Women (CEDAW), and the art. 25 of the Convention on the Rights of the Persons with Disabilities (CRPD). At a European level, right to health is supported by art. 2 and 3 on the European Convention of Human Rights (ECHR) as well as the art. 11 of the European Social Charter that inspired also the art. 35 of the EU Charter of Fundamental Rights (EU CFR).

¹⁴⁹ Later on we will argue about the acceptance of robots in the society. We will zoom in to the conclusions made by the Special Eurobarometer 382's report "Public Attitudes Towards Robots", Wave EB77.1 – TNS Opinion & Social (2012) which highlighted the fact that 65% of the contestants would be in favor of banning service robots in elderly and children's care.

of all details about those pictures (number of persone who were there, how many times the same person came around, etc). This of course raise a new question in terms of data protection and also for the behavior of the interactors with the robot (behavioral targeting¹⁵⁰). This basically means that typical European data protection regulations based on the anonymisation of the person (and his/her personal information) fall short to protect this new phenomenon.

In this regard, in 2016, a robot from Panasonic was awarded ISO 13482:2014. It is called HOSPI(R) and it is an autonomous delivery robot (*see* next Fig.¹⁵¹).

There are specific sub-categories within this sub-type of personal care robot, depending on the robot's functions and capabilities, not reflected yet in ISO. These sub-categories are: cleaning robot, delivery service robot, docent robot, surveillance robot¹⁵² or security robot. For the definition of mobile servant robot, we will exclude Resyone as such. This kind of a robot assists elderly/tired person to and from a chair, bed, etc, it helps perform basic movements on flat ground with or without help and supports an independent living of the users¹⁵³.

Depending on the scenario where they are placed (cleaning, surveillance or servant environment) their functions as well as their interaction with humans, the involved risks will vary substantially. Furthermore, this kind of robots will pose some ethical questions: is it fair to have robot servants ("slavery in the digital age")?¹⁵⁴ What treatment/protection should they receive? Are they going to have salary (energy as a method of payment)? Is it legal to hit a mobile servant robot¹⁵⁵? What happens if the servant cannot understand a hear-impaired person? In case of harm, who is responsible for that?

4. Are Personal Care Robots Social or Non Social Robots?

Personal care robots are service robots but they can be social or non-social. Robots that interact with the human in a social manner will be social (mobile servant robots) and those who do not, are defined as non-social (person carrier and physical assistant robots) (*see* Fig. 10):



Figure 11 Panasonic's Autonomous Delivery Robot - HOSPI(R)

¹⁵⁰ Chen, Y., et al. (2009). Large-scale behavioral targeting. In *Proceedings of the 15th ACM SIGKDD international conference on Knowledge discovery and data mining* (pp. 209-218). ACM.

¹⁵¹ This robot received ISO 13482:2014 in April 2016. *See* more information at news.panasonic.com/global/topics/2016/45099.html

¹⁵² *See* Knightscope at <http://knightscope.com> which is a physical security robot.

¹⁵³ *See* in Annex D, Table D.2 in ISO 13482:2014.

¹⁵⁴ *See* Blanco, R. (2014) Slavery in the Digital Age. Daily Reckoning dailyreckoning.com/profitting-before-the-robot-slaves-revolt/

¹⁵⁵ *See* Darling, K. (2016) Extending Legal Protection to Social Robots: The Effects on Anthropomorphism, Empathy, and Violent Behavior towards Robotic Objects. In: Calo, R., Froomkin, A. M., & Kerr, I. (Eds.). (2016). *Robot law*. Edward Elgar Publishing.

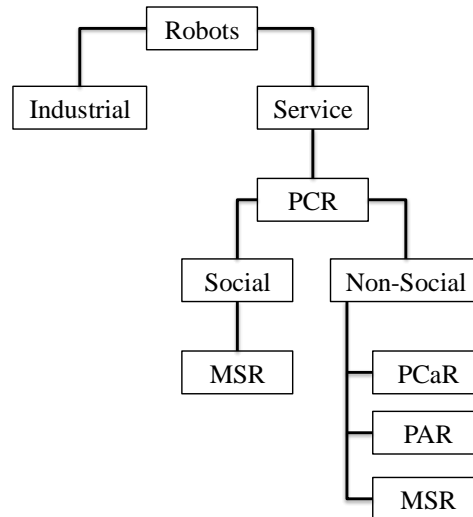

Figure 12 Personal Care Robot Classification¹⁵⁶

- *Task performance.* Person carriers or physical assistant robots help users perform some tasks. The users use them as instruments to achieve a particular goal such as walking to the supermarket or going to the bathroom. Mobile servant robots, on the contrary, do not help users perform a task but the robots perform a task for the user or exchange information with them.
- *Human-Robot Interaction.* In person carriers or in physical assistant robots, the HRI is based on physical contact with the human, i.e. there is “zero distance between robot and an object in its external environment”¹⁵⁷. Despite performing tasks in interaction with humans, mobile servants are different because they interact on a more cognitive level with the users, exchanging of information or understanding a human command and, thus, handle different objects for the user (which are typical tasks of these devices). Person carriers or physical assistant robots instead do not communicate and interact with humans; they do not display adaptive learning behavior, nor simulate human emotional states¹⁵⁸. They are considered non-social robots.
- *Task Detection.* Although the execution of the robot’s movement is different, person carriers and physical assistant robots detect the intention of movement of the user. Both incorporate several sensors to get that information. The sensors can vary a lot depending on what information is needed to execute the movement. Sensors can be invasive if brain-computer interfaces (BCI) are used. Mobile servants, on the contrary, do not work through sensors because they do

¹⁵⁶ This figure just highlights the personal care robot classification without taking into consideration the fact that there might be more types of service robots, as well as other types of industrial robots. For more information, see the next Fig. 11.

¹⁵⁷ See the definition of contact at section 3.19.1 ISO 13482:2014 op. cit.

¹⁵⁸ Breazeal, C. L. (2004). *Designing sociable robots*. MIT press, p.1. A comment here needs to be done. This will depend on the actual capacities of the robot. If the robot is a mobile servant robot (as we will see in chapter 5) that at the same time works as a restraint-free physical assistant robot, then it might be possible that they are considered social robots that incorporate non-social functions. If a carrier talks back to the person in a social manner, then it might be possible that it will be, this robot, considered a social robot. If a robot is a vacuum cleaner, we doubt on its categorization as a social robot. We will talk more about this further on.

not convey the users anywhere. Their goal is to understand the commands from the user and move around to perform the required task.

- *Task Execution.* After detecting the intention of movement, these robots then execute the movement in line with the user's expectations. An important difference between these robots lies at this stage, on the execution of the movement. While person carriers have a sporadic, passive and indirect contact with the robot when performing the movement (e.g. because the user needs to be sat on the robot, get off it), physical assistants tend to be fastened to the body of the user (although there are restraint-free types of PAR) performing a movement in coordination and symbiosis with the user's movement¹⁵⁹.

Although some authors believe that the human tendency to anthropomorphize can be applied to robots¹⁶⁰, there is no scientific evidence that person carriers or physical assistants draw out these projections. And although they are physical and move, they lack the third characteristic Darling ascribes to social robots: social behavior. That is why we call them "non-social robots".

Some objections to this statement could be found in the example of Roomba, the vacuuming robot. This robot is often quoted as an example of a social robot although it lacks the social dimension. People name it; feel sorry if it is stuck under a chair. Sometimes people even clean by themselves so that the Roomba can have a rest¹⁶¹. This is the result of anthropomorphization. However, these robots should be in the category of "non-social service robots".

Overall, we can have one category of social robots: robots that act socially and interact with the user. They recognize voice speech or touch and respond to humans accordingly, or they have a conversation with the user even if very basic¹⁶². We have two categories of non-social robots: 1) service robots that do not interact in a social manner with the user – including autonomous vehicles, person carriers, physical assistants, etc.; and 2) those that are not social – because they do not interact on an emotional level with the users - but with which users still feel some kind of sympathy, like the Roomba case (see Fig. 12).

¹⁵⁹ Moreno, J.C. et al. (2014) Symbiotic Wearable Robotic Exoskeletons: The Concept of the BioMot Project. In: Jacucci et al. (Eds.) Symbiotic 2014, LNCS 8820, pp. 72-83.

¹⁶⁰ See Duffy, B. R. (2003). Anthropomorphism and the social robot. *Robotics and autonomous systems*, 42(3), 177-190. For a more recent revision of this concept see also Darling, K. (2016) op. cit.

¹⁶¹ See Scheutz, M. (2011). 13 The Inherent Dangers of Unidirectional Emotional Bonds between Humans and Social Robots. In Lin, P. et al. (2011) *Robot Ethics: The Ethical and Social Implications of Robotics*, section 6, p. 213.

¹⁶² For instance, the robot dinosaur Pleo or the robot seal Paro they do not talk to the user nor have conversations with them but they respond accordingly when someone touch them, or someone talks to them. They are built in a way that they certainly imitate social cues: blinking eyes or making nice sounds when they are happy. Other more sophisticated robots, the care-o-bot for instance, is intended to be a mobile servant robot, because it performs tasks according to the human commands; but also provides sophisticated presence and some sort of companionship; emulating, therefore, as if the robot was a human caregiver.

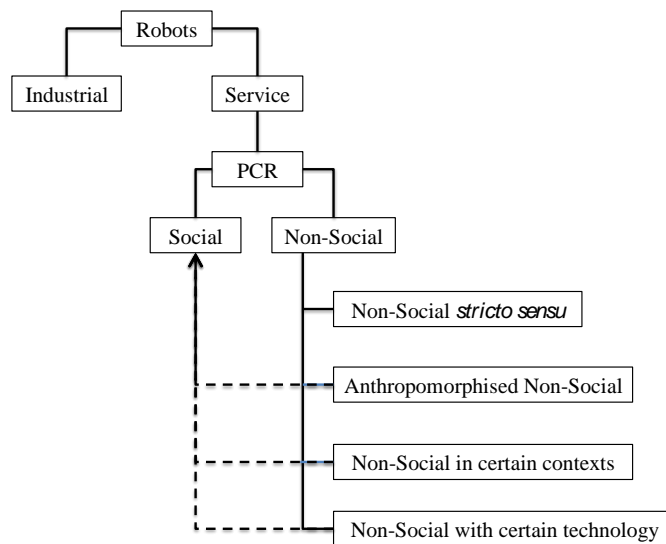

Figure 13 Potential Key Elements for Social Transition

Concerning the non-social-*sensu-stricto* robots, nobody has anthropomorphized the autonomous underground in Lausanne or in Barcelona yet, for instance¹⁶³. Person carriers are not considered public transport but some sort of transport between the public transport and the private one, like a car. They can be for individual or collective use. They are mobile, physical and non-social; and there is no evidence that they are anthropomorphized. Maybe because of the endowment effect, the size of the robot, or the proximity to the action they perform¹⁶⁴, person carrier robots are not yet anthropomorphized. If future robotic carriers will interact with the person on the cognitive level, for instance when an autonomous taxi greets the user, maybe then some sort of anthropomorphization will take place. In any case, it is difficult to imagine these capabilities in all the person carrier categories (segways® for instance) or in physical assistant robots (exoskeletons).

¹⁶³ See more information of metro automation in: <http://metroautomation.org> which is part of the *Union Internationale des Transports Publicques* (UITP), see: <http://www.uitp.org>.

¹⁶⁴ Although we do not have an answer to that, we believe that the size of the robot, the human proximity to the action that the robot performs and the environment, play some role on the anthropomorphization process. Similar to finding lesser of two evils pulling a switch from a distance than pushing the fat man in the trolley problem, we could argue that the more proximity with the action the robot perform we have, the more we will tend to anthropomorphize it. For instance, vacuuming the house was a task that, until now, a human carried out. Independently if the parents, or the charman/charwoman do it, there is some sort of close relationship with the person who cleans. On the contrary, maybe because although humans drive trains, there is not human contact with them, when the human has been removed from the equation “driving human from A to B in undergrounds” nobody anthropomorphizes them. Furthermore, the size counts. There are studies that argue that humans have a tendency to neoteny and pedomorphosis, i.e. the retention of juvenile features in the young animal, and that would explain why humans like small things like puppies, kitties, etc. Humans are also programmed genetically to protect those small things that look vulnerable, a baby for instance. That is why we could have a tendency to anthropomorphize and tend to protect more small robot devices than larger ones.

The distinction between social and non-social is crucial not only when considering extending legal protection to social robots¹⁶⁵, but in general to know how the legal system interprets these robots:

- 1) We cannot assume that only the robots considered “social” deserve some sort of protection or some sort of relevance within the legal order. On the contrary, the whole robot life-cycle process should be a matter of the legal domain, either if it is a law of the horse or not. There should be some guidelines on their legal design and conception, on their use, especially when they are meant for vulnerable people, i.e. children, elderly or infirmed people.
- 2) Contrarily to the definition of Richards and Smart, and in some ways to the robot-anthropomorphism theory, legal relevance of robots should not come from our subjective impression¹⁶⁶ but objectively from the characteristics of the robot itself, the context of its use, the involved HRI and the technology applied to the robot, if not other aspects¹⁶⁷. There should be an institution (the European Robot Agency for instance) that defines robots – independently of the impression and feeling of the user.
- 3) We cannot provide a very narrow definition because some robots could fall out of the category. If we define a social robot as: (1) an embodied object with (2) a defined degree of autonomous behavior that is (3) specifically designed to interact with humans on a social level and responds to mistreatment in lifelike way; then the Roomba robot would fall out of the category even if everyone is treating it as a social robot¹⁶⁸.

Dautenhahn and Billard defined a social robot in 1999 as:

Embodied agents that are part of a heterogeneous group: a society of robots or humans. They are able to recognize each other and engage in social interactions, they possess histories (perceive and interpret the world in terms of their own experience), and they explicitly communicate with and learn from each other¹⁶⁹

Although it might be arguable whether robots really recognize each other or if social robots engage in social interactions (between them), it is true that the more and more robots are socially aware, learn from experience (with machine learning techniques) and from other robots through cloud robotics. In 1999, Breazeal and Scassellatti were

¹⁶⁵ Because this somehow only relates to the protection of robots against abuse or mistreatment as Darling highlights in her op. cit., but disregards other parts of the legal framework such as the rights and duties not only from the robot perspective but also from the creator of it.

¹⁶⁶ At risk that some parts of the population (e.g. elderly or young children) can confuse robots with other alive-beings. For contrary opinions, as we said before, Joseph Engelberger believed that “I can’t define a robot but I know when I see one”; which would reinforce this subjective argument.

¹⁶⁷ This is in part similar to what happens with Unmanned Autonomous Vehicles (UAV) and their regulations. Independently of the anthropomorphization of these robots, there is the need to create regulations that state what are the limits on the use of them, how they should be designed, etc. See in any case Fosch-Villaronga, E. (2015) Principles Involved in Care Robotics Legal Compliance. Proceedings NewFriends 2015 Conference, Almere, The Netherlands.

¹⁶⁸ Darling (2016) op. cit.

¹⁶⁹ Dautenhahn, K., & Billard, A. (1999, April). Bringing up robots or—the psychology of socially intelligent robots: From theory to implementation. In *Proceedings of the third annual conference on Autonomous Agents* (pp. 366-367). ACM.

working on robots that could interact socially with humans.¹⁷⁰ Miwa et al. highlighted in 2001 that the personality of the robot was especially important in achieving smooth and effective communication with humans.¹⁷¹ In 2003, Fong, Nourkbahsh and Dautenhahn presented a review of the common features of social robots.¹⁷² According to them, social robots expressed/perceived emotions, communicated in high-level dialogue, learned/recognized models of other agents, established/maintained social relationships, used natural cues – such as gaze or gestures – exhibited distinctive personality and character, and that might learn/develop social competencies. They agreed that social robots could be very different: from robots that uniquely engage people in social interactions to robots that were programmed to fulfill social norms and carry out tasks in human environments. Fong, Nourkbahsh and Dautenhahn also mentioned that some of these robots use deep models of human interaction to proactively encourage social interaction, while others would rely on humans to attribute mental states and emotions to the robot. To this, and similar to the idea that the complexity of the behavior of an ant is more a reflection of the complexity of its environment than its own internal complexity (speculated that the same may be true for humans),¹⁷³ the environment can influence the behavior of a robot directly, through sensors, or indirectly by the action of the user.

In 2009, Hegel provided different definitions of social robots¹⁷⁴ presenting the work of Fong et al.¹⁷⁵, Breazeal¹⁷⁶ and Duffy¹⁷⁷, and he summarized the work of these researchers as follows:

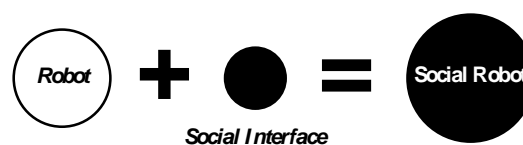

Figure 14 Understanding social robots. Hegel et al. op. cit.

More recently, Darling provided his definition of social robots:

- (1) an embodied object with
- (2) a defined degree of autonomous behavior that
- (3) specifically designed to interact with humans on a social level and respond to mistreatment in a lifelike way

¹⁷⁰ Breazeal, C., & Scassellati, B. (1999). How to build robots that make friends and influence people. In *Intelligent Robots and Systems, 1999. IROS'99. Proceedings. 1999 IEEE/RSJ International Conference on* (Vol. 2, pp. 858-863). IEEE.

¹⁷¹ Miwa, H., et al. (2001). Experimental study on robot personality for humanoid head robot. In *Intelligent Robots and Systems, 2001. Proceedings. 2001 IEEE/RSJ International Conference on* (Vol. 2, pp. 1183-1188). IEEE.

¹⁷² Fong, T. et al. "A Survey of Socially Interactive Robots. *Robotics and Autonomous Systems*, 42, 2003, p. 145

¹⁷³ Simon, H. A. *The Science of the Artificial*. MIT Press, Cambridge, Massachusetts, 1996

¹⁷⁴ Hegel, F., Muhl, C., Wrede, B., Hielscher-Fastabend, M., & Sagerer, G. (2009, February). Understanding social robots. In *Advances in Computer-Human Interactions, 2009. ACHI'09. Second International Conferences on* (pp. 169-174). IEEE.

¹⁷⁵ Fong, T. (2003). A survey of socially interactive robots. *Robotics and autonomous systems*, 42(3), 143-166.

¹⁷⁶ C. Breazeal (2002). *Designing Sociable Robots*. Cambridge, MA, USA . MIT Press

¹⁷⁷ B. Duffy (2000). *The Social Robot*. PhD Thesis, Department of Computer Science, Univ. College Dublin

The last part of the definition refers to the workshop she carried out at Massachusetts Institute of Technology (MIT) with the mistreatment of the robotic dinosaur Pleo. This might be not applicable to general causes because the robot might respond lifelike also in other situations (not only in mistreatment cases). De Graaf suggested that what makes a robot social is, in reality, the two-way interaction: social robots express or understand thoughts or feelings, are socially aware, interact unpredictably or spontaneously, and provide the feeling of companionship or of mutual respect¹⁷⁸.

At this stage, and as the state of the art grows exponentially¹⁷⁹, providing a definition of social robot would clash, in reality, with the bottom-up approach. We do not underestimate the importance of having a definition. Nevertheless, literature is so vast, with some contradictions (considering vacuum cleaners as social robots just because of our tendency to anthropomorphize). The main focus should in fact be to reveal and identify the characteristics of a robot, the technology applied to it, the contexts of use, its HRI. This would help us understand the type of robot we are dealing with, and the legal framework and guidelines that should be applied. The regulation of a specific robot would then be like a puzzle where the different modules – namely characteristics, technology, context, HRI, and users – come to play (*see* future work at the end of this work). Consequently, Law would be able to interpret and regulate robots regardless of definitions or categories, but rather according to the inner characteristics of robots.

The category of social is transversal and not specific to one type of robot only. The category does not depend on the tasks, but on how this is carried out: with or without social interaction with humans. So besides being a carrier or a physical assistant robot, a robot might also have some interaction capabilities typical of social robots. While in companion robots the primary functions are social; in carriers or physical assistants, social interactions are complementary or secondary and unnecessary to perform their primary task. In mobile servant robots, social interactions are secondary (because the robot still performs a task), but necessary. In companions, social functions are the primary function.

5. Robots excluded by ISO 13482:2014

ISO 13482:2014 was born to specify “requirements and guidelines for the inherently safe design, protective measures, and information for use of personal care robots”¹⁸⁰. Therefore, robotic devices will be covered by this standard if used in personal care applications, which limits the contexts of use. ISO 13482:2014 also establishes that it is limited to earthbound robots. It also clearly states the limitations:

This International Standard does not apply to:

- robots travelling faster than 20 km/h;
- robot toys;
- water-borne robots and flying robots;
- industrial robots, which are covered in ISO 10218;
- robots as medical devices;
- military or public force application robots.

¹⁷⁸ de Graaf, M. M. A., Allouch, S. B., & van Dijk, J. A. G. M. (2015, October). What makes robots social?: A user’s perspective on characteristics for social human-robot interaction. In *International Conference on Social Robotics* (pp. 184-193). Springer International Publishing.

¹⁷⁹ Pistono, F. (2014). Robots will steal your job, but that’s ok: how to survive the economic collapse and be happy. Federico Pistono

¹⁸⁰ See section 1, scope, of ISO 13482:2014 about ‘Robots and Robotics Devices – Safety Requirements for Personal Care Robots’.

As stated above, this ISO covers robotic devices used in personal care applications. Personal care seems to be understood differently by the healthcare community. In fact, this ISO does not provide a definition personal care, nor information on specific users like elderly/infirm people.

Secondly, ISO 13482:2014 is limited to earthbound robots. That basically means that this standard does not involve space robots. Functions of these robots do not enhance nor improve the quality of life. For instance, Curiosity has the goal to look for signs of life on the Red Planet¹⁸¹.

Thirdly, this standard does not apply to robots travelling faster than 20 km/h, robot toys, water-borne robots and flying robots, industrial robots, robots as medical devices nor military or public force application robots:

5.1. Robots travelling faster than 20 km/h

These robots could be all kind of autonomous ground vehicles. They can include public initiatives like Personal Rapid Transit (PRT) in some cities like Masdar (UAE) or Sunchteon (KR); or others in smaller environments like London Heathrow Airport (UK); also private initiatives like Google car; this kind of unmanned ground vehicles (UGV) are out of the scope of the international standard. This is because the majority of these unmanned vehicles reach a speed of 40 km/h (if these are public transports in closed tracks) or more if they are personal cars¹⁸². However, the criterion of speed is quite a limitation, indeed there are some segways (person carriers) that have a speed limit higher than 20 km/h. Should they be outside of the scope then? Or is this similar to what happens with cars (despite speed limits, car engines are capable to go faster than that)? Would it be safe for an elderly to use a segway that can go 30 km/h?

There are no available studies yet on the impact of speed of this robot technology. Although the ISO refers to person carrier robots which are meant to travel, their intended use is for personal care, so to help mobility of people with some disabilities or to facilitate mobility of groups of people to places where public transportation does not arrive. Up to now, there has been an effort to create and draft regulations on autonomous driving cars, but no great effort on knowing the fundamental principles that could be also applied to other robots traveling on ground autonomously (*see* chapter 4).

Excluding robotic traveling devices that go faster than 20km/h could represent a higher risk for the users. Based on this speed limit, it seems that ISO aims to cover only robots that move in known and pre-defined environments: hospitals, nursing homes, dwellings or, at most and in any case, in the street to go shopping, go for a walk, etc. However, there can be some concerns when these devices hit the streets (because the person wants to go to the supermarket for instance). Lots of data will have to be processed so as to avoid collision or any unfortunate scenario. Moreover, there are many parallelisms with other ground vehicles.

5.2. Robot toys

There are so many different kinds of robot toys for children: entertainment robot toys, educational robots, robot pets, etc. Their purposes are many depending on the

¹⁸¹ See for further information the website of NASA: www.jpl.nasa.gov/msl/

¹⁸² See more information on personal rapid transit vehicles, their speed and the evolution of it here: <http://www.skytran.com/prt/>

goal they are designed for. One thing for sure is that they are excluded expressly by the personal care ISO. An example of this kind of robots could be the famous Pleo. This cute four-life-stage dinosaur robot toy is the materialization of the so-called Tamagotchi: you can feed it, play with it, teach it, etc. Unfortunately, its functions do not include taking care of any user.

There are several robot toys that help children with disabilities not only for rehabilitation purposes but just to improve their quality of life. This is the case of electric-powered child-sized toy cars that offer mobility to children with disabilities¹⁸³. As explained by Galloway, wheelchairs are reserved for children over 3 years old and new robotic devices to help disabled children's mobility cost tens of thousands of euros and are very heavy¹⁸⁴. To cope with such limitations, he founded the project "Go Baby Go" in order to take already commercialized car toys and to transform, adapt and robotize them for children with cerebral palsy or Down syndrome to move¹⁸⁵. It is difficult to really understand whether these car toys can be considered person carriers as there is the category of "wheeled passenger carrier" or if they should be considered wheelchairs under the medical device regulation (see Fig 14). What is for sure is that the transformation of existing things into robots, or robots into other robots (for instance there are segways that transform into mobile servant robots just with a button, see chapter 4) challenges current standards and existing categories. They are new creations that combine existing features of their original shape/thing, but they may also incorporate new futures. This inevitable changes also the regulation to apply (for instance a robot toy car that is now a wheelchair) or creates a meta-category not yet defined in the standards.



Figure 15 Go-Baby-Go project of prof. Galloway

Iromec is another example. It is "a modular robot companion tailored towards engaging in social exchanges with children with different disabilities with the aim to empower them to discover a wide range of play styles from solitary to social and cooperative play"¹⁸⁶. These robots are not simply toys since they improve the reduced capabilities of children with disability. The question here is: could car toys be understood like *person carrier robots* as described in the ISO when they are modified to help a disabled child?

¹⁸³ Kravetz, A. M.: Toys Cars Offer Mobility to Children with Disabilities. Live Science (2012)

¹⁸⁴ The bulkiness and weight of wheelchairs is a key factor on the acceptance of these devices.

¹⁸⁵ Galloway, J.C.; Ryu J.; and Agrawal S.K. (2008) Babies Driving Robots: Self-Generated Mobility in Very Young Infants. Intel Serv Robotics, 1, pp. 123-134

¹⁸⁶ See Marti, P. et al. A Robotic Toy for Children with Special Needs: From Requirements to Design. IEEE 11th International Conference on Rehabilitation Robotics. Kyoto International Conference Center (2009).

Although these robots *perform actions contributing directly towards improvement in the quality of life of humans*, the current discussion lies on deciding whether these devices are considered therapeutic robots – medical devices – or toy robots¹⁸⁷

5.3. Water-borne robots and flying robots

Drones are a modern fashion. These unmanned aerial vehicles (UAV) that can be remote controlled or fly autonomously, have caught lately all the juridical attention. Several recommendations and laws came out for drones, which did not happen in the personal care domain¹⁸⁸. This is because of the consequences of their use either in military applications or in surveillance applications. Independently of their legal implications¹⁸⁹, it seems they are out of the scope of the international standard that addresses personal care robots. Indeed, drones used as autonomous weapon systems downheartedly have already killed lots of citizens¹⁹⁰. However, not all drones have been used for these purposes. The “drones for good” is an initiative that tries to use drone technology to help people¹⁹¹. Although it might not be considered as “personal care”, depending on the capabilities of this future technology we will be able to incorporate them in this category. At least some response from the legal domain will have to be given to those mixing categories that already exist, like for instance a robotic prosthetic arm that incorporates a drone. The phantom limb project is a research conducted by The Alternative Limb Project and has created this robotic prosthetic that, among several other things, incorporates a bespoke quadcopter that the user can fly with a one-hand controller¹⁹².

Water-borne robots on their side have normally been used to investigate ice caps, to build deep-sea oilrigs, to repair undersea cables, or to mitigate natural disasters. Among various functions, it is noteworthy to mention the dramatic growth of drug smuggling waterborne robots used by criminal organizations. Drug subs are not new, however their effectiveness is getting more and more unquestionable: “They can act on their own when required, employ programmed avoidance routines to thwart authorities, be fitted with sensors to send signals to the operator when the payload is delivered or the craft attacked, and carry self-destruct features to destroy incriminating evidence”¹⁹³. As we can see, none of these uses has something to do with the goal pursued by the international standard 13482:2014.

A lot of research has been conducted in comparing the use of a robotic body-weight system that provides assistance in walking through robotic technology and aquatic-based exercises providing support¹⁹⁴. The good properties of water are well known (indeed many rehabilitation and wellness activities are developed in swimming pools), in the future it is likely that robotic technology and water applications will combine (personal care or therapy), like using the octopus Kraken¹⁹⁵.

¹⁸⁷ Albo-Canals, J. (2015) op. cit.

¹⁸⁸ FAA released in 2016 a set of operational rules on small-unmanned aircraft systems, see www.faa.gov/uas/media/RIN_2120-AJ60_Clean_Signed.pdf. For a summary of these rules see www.faa.gov/uas/media/Part_107_Summary.pdf

¹⁸⁹ See Knoops, G.A. Legal, Political and Ethical Dimensions of Drone Warfare under International Law: A Preliminary Survey. *International Criminal Law Review*, vol. 12, issue 4, pages 697-720 (2012).

¹⁹⁰ See Johnston, P.; Sarbahi, A.K. The Impact of U.S. Drone Strikes on Terrorism in Pakistan and Afghanistan. Unpublished manuscript available at: <http://patrickjohnston.info/materials/drones.pdf> (2014).

¹⁹¹ You can see more information at www.alecmomont.com/projects/dronesforgood/

¹⁹² See all this information at www.thealternativelimbproject.com/project/phantom-limb/

¹⁹³ See Sharkey, N.; Goodman, M.; Ross, N. The Coming Robot Crime Wave. *IEEE Computer Society* (2010).

¹⁹⁴ See <http://umrehabortho.org/research/ct/lokomat-aquatic-therapy>

¹⁹⁵ See www.gizmag.com/robot-octopus-swimming/27969/

If we have a closed taxonomy it will be very difficult to cope with future technology, which will likely be highly mixed.

5.4. Industrial robots

ISO 13482:2014 states that this international standard complements ISO 10218-1, which covers the safety requirements for robots in industrial environments only. Apparently, ISO introduced this new standard in 2014 working towards a new benchmark that could embrace and recognize the particular hazards presented by newly emerging robots¹⁹⁶. Indeed, the increasing robots providing services in non-industrial contexts is a new phenomenon.

In this case, ISO decided to tackle personal care robots. It is true that there are other emerging robots dealing with society challenges in non-industrial contexts, like for education purposes, and it is not sure whether personal care robot standard will be the framework for them. This is similar to what happens with the robotic vacuum cleaner: Gurvinder Virk, the Chairman of these regulations, argued that the robotic vacuum cleaner is included in the scope of the ISO¹⁹⁷, but it is not very clear in the ISO itself (as there is no reference to cleaning activities, nor they “exchange information or handle objects”, which are typical activities of personal care robots)¹⁹⁸. However, when settling down rules and standards for new products or technologies, there should be a balance between their flexibility and suitability to their specific content. At this point it just seems that ISO13482:2014 is an attempt to regulate through an industrial and technical standard something no other organization has done before. Yet, this attempt lacked concreteness and dynamism. If we regulate the future with instruments from the past we will never make it.

Industrial robot can be defined, as an “automatically controlled, reprogrammable multipurpose manipulator, programmable in three or more axes, which can be either fixed in place or mobile for use in industrial automation applications” (ISO 10218-1:2011). There are some differences between industrial robot and the service robot definition in ISO 13482:2014. That is why they are regulated in different bodies. Firstly, robots and robotic devices in personal care applications require close HRI and collaborations, as well as physical human-robot contact; while in industrial robots HRI is less present. Secondly, service robots perform useful tasks for humans, industrial robots do not. Thirdly, industrial automation applications are excluded from the ISO regulating personal care robots¹⁹⁹.

The more collaborative robots will raise, the higher the HRI will be and the blurrier this distinction will be, as the risks present in both types of robots will be similar.

¹⁹⁶ See second paragraph of ISO 13482:2014’s introduction.

¹⁹⁷ Virk, G. (2014) New ISO 13482 Robot Safety Standard Published. *See* clawar.org/wp-content/uploads/2015/04/ISOStandardization.pdf

¹⁹⁸ *See* all the examples he had in mind when defining them: <https://clawar.org/wp-content/uploads/2015/04/ISOStandardization.pdf> While Asimo, Care-o-Bot and REEM seem to be clearly a fit for the definition of mobile servant robot, Roomba is not very clear why is there.

¹⁹⁹ In fact, in the same ISO 10218-1:2011 it is established in its introduction that ‘this part of ISO 10218 does not apply to non-industrial robots’. It is also true that it adds that ‘although the safety principles established in ISO 10218 can be utilized for these other robots’. In fact, it is true: ISO 13482:2014 later on takes some definitions of the industrial-robot one, and includes them modified in it (3.9. safe state, or 3.28 singularity for instance).

5.5. Robots as medical devices

Healthcare in itself is a world full of sub-areas where robots can develop important tasks such to help practitioners and patients achieve accuracy and efficiency impossible for humans. One standard only cannot cover this vast field, especially due to the wide range of sub-areas: industrial robots manufacturing pills, robotic surgery (da Vinci²⁰⁰), nanotechnology (smart pills²⁰¹), etc. Although they perform actions contributing directly to improvement in the quality of life of humans, their use normally does not match the common definition of personal care. Furthermore, the same international standard excludes them expressly in several occasions. Nevertheless, standards are not legitimate to overpower binding force pieces of legislation. European Union legislative framework, in fact, can make a very interesting turn to modify this exclusion.

Medical intervention robots – surgery robots, such as the DaVinci Robot²⁰² – may have to comply with medical device regulation.²⁰³ In the light of a regulatory gap,²⁰⁴ care robots may have to follow ISO 13482:2014 on Personal Care Robots, which is based on the machinery directive. However, there are physical assistant robots that are used in rehabilitation that have to follow medical device regulation.²⁰⁵ That is why one can find exoskeletons that have medical and non-medical device version to comply with both legal corpuses.²⁰⁶ That concerns physical rehabilitation robotic devices. For cognitive rehabilitation robots – those robots used in therapeutic settings for neurodevelopmental disorders such as autism or Traumatic Brain Injury²⁰⁷ – there is an ongoing discussion on whether they fall under the medical device legislation, or whether they are toy robots.²⁰⁸ This discussion is fed by distributors – because, for instance, the seal PARO is commercialized in the U.S. as a medical device, when in Spain is commercialized as a non-medical device,²⁰⁹ – but also by the creators of technology, who dissociate the characteristics of the device and its use to avoid the

²⁰⁰ See more information on <http://www.davincisurgery.com/da-vinci-surgery/da-vinci-surgical-system/?gclid=Cj0KEQjwjk-BRCzv-Wyu4OTosEBEiQAgFp5OCEDuGkzTmDsZTCwZXq5WcZULGPmFnps35nnuGyOOYaAv6T8P8HAQ>. For information about the inclusion of a third robotic arm in this system, see the work conducted by our colleague Elahe Abdi at EPFL Abdi, E., Burdet, E., Bouri, M., Himidan, S., & Bleuler, H. (2016). In a demanding task, three-handed manipulation is preferred to two-handed manipulation. *Scientific reports*, 6; available at <http://www.ncbi.nlm.nih.gov/pmc/articles/PMC4766403/>.

²⁰¹ See Caffrey, C.M. et al. Swallowable-Capsule Technology. *IEEE CS, Pervasive Computing*, pages 23-29 (2008).

²⁰² Visit: www.davincisurgery.com

²⁰³ Council Directive 93/42/EEC concerning medical devices (as amended by Directive 2007/47/EC) named *Medical Device Directive* but also the Council Directive 90/385/EEC on the approximation of the laws of the Member States relating to active implantable medical devices, abbreviated as AIMDD.

²⁰⁴ Holder, C., Khurana, V., Harrison, F., & Jacobs, L. (2016). Robotics and law: Key legal and regulatory implications of the robotics age (Part I of II). *Computer Law & Security Review*, 32(3), 383-402.

²⁰⁵ Fosch-Villaronga, E. (2016). ISO 13482: 2014 and Its Confusing Categories. Building a Bridge Between Law and Robotics. In *New Trends in Medical and Service Robots* (pp. 31-44). Springer International Publishing.

²⁰⁶ The company Cyberdyne has a Hybrid Assistive Limb (HAL®), one for medical use and others for non-medical uses. See in products section at: www.cyberdyne.jp/english/products/HAL/

²⁰⁷ Barco, A., et al. (2014, August) op. cit.

²⁰⁸ Albo-Canals, J. (2015) op. cit.

²⁰⁹ See www.parorobots.com

medical device regulation²¹⁰. In theory, it is well-known that the intended use should be the one that primes in these uncertainties.²¹¹⁻²¹²

Fortunately, these regulatory confusions revolving this type of devices are coming to an end. In September 2012, a proposal for a Regulation of the European Parliament and of the Council on medical devices was released, and approved in April 2017.²¹³ The article 1.3. states that “devices with both a medical and a non-medical intended purpose shall fulfill cumulatively the requirements applicable to devices with an intended medical purpose and those applicable to devices without an intended medical purpose”. This would mean that both exoskeletons and cognitive therapeutic robots that have medical and non-medical version will have both to comply with the medical device regulation.

Art. 12 of the Regulation on Medical Device “Devices which are also machinery within the meaning of point (a) of the second paragraph of Article 2 of Directive 2006/42/EC of the European Parliament and of the Council shall, where a hazard relevant under that Directive exists, also meet the essential health and safety requirements set out in Annex I to that Directive to the extent to which those requirements are more specific than the general safety and performance requirements set out in Chapter II of Annex I to this Regulation”. This is very important because, although ISO 13482:2014 goes in line with ISO 12100:2010 concerning the safety machinery, the European directive on machinery (Directive 2006/42/EC of the European Parliament and of the Council of 17 May 2006 on machinery) dates back to 2006, and does not include any updates concerning the ISO from 2010 or the one about personal care robots of 2014, which could lead to a regulatory gap.

This could basically mean that, although the efforts of the ISO to come up with a regulation about a more specific scope, i.e. the personal care robot non-medical scope, obtaining the certification might not be useful if the devices are going to be compliant with the medical device regulation. That is why it is so important to know what kind of scenarios we are talking about and the differences and similitudes that we find in both places. This might be the case of physical assistant robots: although being used in rehabilitation and in activities of the daily living²¹⁴, both types will have to comply with the medical device regulation.

5.6. Military or public force application robots

Similarly to drones, the scope of ISO 13482:2014 is nothing but addressing safety requirements for personal care robots. These robots have a precise and well-defined goal, that is, to improve the life of the intended users. That is why we talk about ‘service robots’. In fact, they perform tasks for the sake of human care. Instead, military robots are completely out of this scope. The future of robotic technology might surprise: considering the different mixing categories of personal care robots, there

²¹⁰ See www.origamirobotics.com/therapy

²¹¹ Gamerman, G. E. (1992). Intended use and medical devices: distinguishing nonmedical devices from medical devices under 21 USC 321 (h). *Geo. Wash. L. Rev.*, 61, 806.

²¹² EC DG Health and Consumer Directorate B, Unit B2 “Cosmetics and medical devices”. See ec.europa.eu/consumers/sectors/medical-devices/files/meddev/2_4_1_rev_9_classification_en.pdf

²¹³ In May 2017 they will be published in the Official Journal, but the texts are already available at: data.consilium.europa.eu/doc/document/ST-10728-2016-REV-4/en/pdf

²¹⁴ Independently of the fact that they are used for the industry or for the military field we have already argued that these devices are not part of the military code nor part of the industrial robots regulations; they are part of the activities of the daily living as long as they do not increase per se the productivity of the industry or do not constitute part of the Military code (which governs basically the relationship that the military people have).

might be an the categories of military and personal care robots might somhow overlap in the future. If an exoskeleton (HULC for instance that has been used in military contexts) does not incorporate any gunfire, and it only provides physical assistant to the person, it might be considered personal care robot; if, on the contrary, it incorporates some gunfire, this might change.

2. Chapter - Personal Care Robots Legal Framework: Beyond Current State of the Art

There is urgency in coming to see the world as a web of interrelated processes of which we are integral parts, so that all of our choices and actions have consequences for the world around us. Robert Mesle.

1. Industrial Standards as a Frame for Personal Care Robots

A roboticist building a robot that interacts with humans may be clueless about what regulations apply to it, whether the robot behavior needs to be regulated by design²¹⁵ or whether s/he is in charge of it. Sometimes, even the law is not prepared to accommodate new types of technology right away, e.g. driverless cars²¹⁶. Thus, in the light of the creation of a new technology or a new use of a particular technology, an assessment of the impacts of the technology should be carried out.

This assessment should be held first against regulation to ascertain that this new technology (in this case robot) or this new use remains within the existing liberty space. If the creator of the robot does not encounter any limitations, it is logical that s/he will proceed with its development. If, on the contrary, there are some limitations, the robot creators will either (1) adjust the robot to the limitations and comply thus with the existing regulatory framework; (2) negotiate with the regulators about the possibility to change the law, so that the original robot is compliant with a new regulation; or (3) carry out the original plan and risk to be non-compliant.

The creators of personal care robots found themselves in this situation time ago. Before 2014, the regulation governing robots (i.e. Machinery Directive) focused on industrial robots whose interaction with humans was practically minimal. Considering the impossibility to find a room in the legislation, most of research centers (and also industries) went ahead and started developing personal care robots. First person carriers because they are easier to automat, then exoskeletons that brought a new conception for limb impaired people and later on mobile servants, which incorporate more sophisticated characteristics and took more time to develop. In view of the rapid evolution that these robots were having, a technical framework was presented in February 2014 – the ISO 13482:2014 Robots and Robotics Devices, Safety Requirements for Personal Care Robots. Instead of fencing the robots off the humans as previous standards did to prevent the hazards involving industrial robots, this standard addresses the physical human-robot interaction hazards by stipulating safety requirements on several design factors such as robot shape, robot motion, energy

²¹⁵ Leenes, R., and Lucivero, F. (2014). Laws on robots, laws by robots, laws in robots: Regulating robot behaviour by design. *Law, Innovation and Technology*, 6(2), 193-220

²¹⁶ Weng, Y. H., et al. op. cit.

supply and storage or incorrect autonomous decisions. Seeing the standard/the limitations, some creators wanted to adjust to them and gain the certificate from ISO²¹⁷.

When there is the need to discuss existing (absence of) regulation, the regulator can discuss with the developers and give a legal response accordingly. The creation of a private standard is one of the four types of regulatory responses that exist when balancing social good and individual burden of newly emerging technologies according to Smith (*see next Figure*)²¹⁸, and normally refers to the instrument that gives response to those less compelling and more in the private context interests.

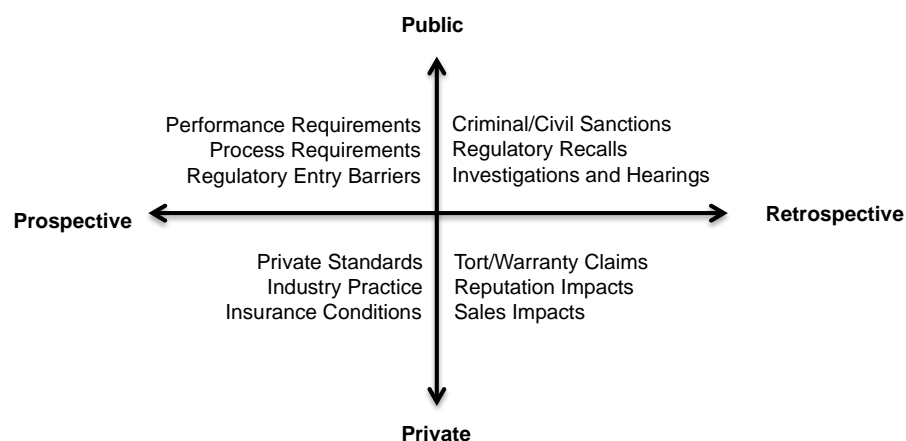

Figure 16 Quadrants of Regulation from B. W. Smith (2016)

As Nelson explains²¹⁹, standards help provide risk management assistance limiting liability and help producers meet the market demands²²⁰. They are considered soft Law²²¹. Soft legislation provides good alternatives for dealing with many international issues that are new, specific and complex, especially when States cannot foresee the consequences of a legal document. Standards are flexible, seen as a tool of compromise, and sometimes the basis of legal corpuses such as the Machinery Directive 2006/42/EC or the Medical Device Directive 93/42/EEC²²².

In an ideal world, robots are clear of impacts and therefore threats can be responded in terms of prevention and opportunities in form of facilitation. In practice, nonetheless, certainty about impacts of robots are often less clear, especially when they are inserted with the aim to care about someone else. Therefore, regulators will have to address uncertain risks, ambiguity of impacts and ignorance about the effects of impacts²²³. At the same time, moreover, standards are non-binding and are voluntarily

²¹⁷ See for instance Resyone from Panasonic: news.panasonic.com/global/topics/2014/26411.html

²¹⁸ Bryant Walker Smith, Teil V, (2015) Regulation and the Risk of Inaction, in: Maurer et al. (eds.), *Autonomes Fahren* pp 593-609: http://link.springer.com/chapter/10.1007/978-3-662-45854-9_27

²¹⁹ Nelson, R. (2015) Robot Safety Standard Update. Presentation available at: www.robotics.org/userassets/riauploads/file/TH_RIA_Roberta_Nelson_Shea.pdf

²²⁰ As Nelson op. cit. clarifies: “presuming the market demands compliance with the standard”.

²²¹ Shelton, D. (2003). *Commitment and compliance: The role of non-binding norms in the international legal system*. Oxford University Press

²²² See ec.europa.eu/growth/single-market/european-standards/harmonised-standards/index_en.htm. See also Krut, R., and Gleckman, H. (2013). Op. cit.

²²³ Fosch-Villaronga, E. and Heldeweg, M.A. (2017) Rethinking Regulation for Experimenting with Emerging Robotic Technologies. Staatsrechtconferentie 2016, University of Twente. Forthcoming.

adopted²²⁴, they represent the capitalization of Law (because they cost money) and they are self-interpretations of the industry reality. These characteristics lead to question the legitimization of standards²²⁵. On the contrary, legislation (or “hard law”) stands for legally binding obligations. They are precise or can be specified through regulations. Contrary to soft-law, hard law enhances the capacity for enforcement (i.e. allowing allegations and defenses to be tested under accepted standards and procedures when a violation is found); hard-law constraints self-serving auto-interpretation; it fixes consequences for violations (and also provides “proportional countermeasures” where other remedies are unavailable); it implies a specific form of discourse (that disqualifies arguments based solely on interests and preferences); and it entails higher reputational costs (that reflect “distaste for breaking the law”)²²⁶.

Healthcare robots share many areas of technical commonality with electrically powered medical devices as pointed out in the Robobusiness Review²²⁷. They both have the same drivers, in social terms – aging population, increased number of disabled, same expectations, money and political power; in technological terms – increasing miniaturization of electronic devices, lighter systems, new classes of materials; and in business terms – the costs, the labor shortage and the quality and safety of the systems. Yet, there are substantial differences in robot performance and in HRI that make personal care robots be in another category²²⁸

2. Evolution of the Legal Discussion on Robots

Appraising political pressure, expert opinion or policy agenda, sometimes the regulatory bodies can *ex officio* reconsider an existing regulation. Other times it could be that regulatory action is required to provide greater clarity, effectiveness, efficiency and/or legitimacy, especially when the involved interests are more compelling and public²²⁹.

In 2004, the First International Symposium on Roboethics took place in San Remo, Italy. It was the first time that the word “Roboethics” was used. In 2004, the Fukuoka World Robot Declaration was also written. The declaration stated the expectations for

²²⁴As ISO states in their website, ISO standards are voluntary. ISO is a non-governmental organization and it has no power to enforce the implementation of the standards it develops. A number of ISO standards - mainly those concerned with health, safety or the environment - have been adopted in some countries as part of their regulatory framework, or are referred to in legislation for which they serve as the technical basis. However, such adoptions are decisions by the regulatory authorities or governments of the countries concerned. ISO itself does not regulate or legislate. Although voluntary, ISO standards may become a market requirement, as has happened in the case of ISO 9000 quality management systems, or ISO freight container dimensions. See www.iso.org/iso/home/faqs/faqs_standards.htm See also www.bsigroup.com/LocalFiles/en-GB/consumer-guides/resources/BSI-Consumer-Brochure-Personal-Care-Robots-UK-EN.pdf

²²⁵ In the following chapters we will explain why we think roboticists should not be legitimated to address the ethical part of robotic technology.

²²⁶ Abbott, K.W. and Snidal, D. (2000). Hard and Soft Law in International Governance. International Organization, 54, pp. 421-456

²²⁷ RBR Staff (2009) Healthcare Robotics: Current Market Trends and Future Opportunities. See www.roboticsbusinessreview.com/health-medical/healthcare-robotics-current-market-trends-and-future-opportunities/

²²⁸ Such category might be clear in the industrial standards realm, but not in the legislation terms, as it is not clear whether the medical device directive will apply to certain devices or whether they will be covered by the safety machinery, or, even, if there will be a new regulation that will cover these specific devices.

²²⁹ Fosch-Villaronga, E. and Heldeweg, M. A. (2017) op. cit.

next-generation robots and the creation of new markets for new robotic technology²³⁰.

In 2006, the same group of researchers (leader Veruggio) asked for the creation of a research atelier on the same topic, as a following-up session²³¹. The aim of that atelier was to develop the concept that, after 10 years, would be one of the most trending topics in the world of law and new technologies: the concept of Roboethics. They released a Roboethics roadmap right after the meeting where they highlighted many regulations and codes that could be relevant for roboticists²³².

In 2010, different experts gathered at the Engineering and Physical Science Research Council (EPSRC) to talk about robotics, their application in society and how they would have to be shaped to benefit society. They came up with 5 ethical rules for designers, builders and the users of robots (Fig. 1)²³³ and called them the New Rules for Robotics:

LEGAL	GENERAL AUDIENCE
Robots are multi-use tools. Robots should not be designed solely or primarily to kill or harm humans, except in the interests of national security.	Robots should not be designed as weapons, except for national security.
Humans, not robots, are responsible agents. Robots should be designed; operated as far as is practicable to comply with existing laws & fundamental rights & freedoms, including privacy.	Robots should be designed and operated to comply with existing law, including privacy.
Robots are products. They should be designed using processes which assure their safety and security.	Robots are products: as with other products, they should be designed to be safe and secure.
Robots are manufactured artefacts. They should not be designed in a deceptive way to exploit vulnerable users; instead their machine nature should be transparent.	Robots are manufactured artefacts: the illusion of emotions and intent should not be used to exploit vulnerable users.
The person with legal responsibility for a robot should be attributed.	It should be possible to find out who is responsible for any robot.

Table 2 EPSRC Five principles for designers, builders and the users of robots

Among different aspects, they identified the problem of killer robots, which was already highlighted by Sharkey in 2007^{234,235}. In addition, they supported the idea that humans were the ones considered “responsible agents”. They also argued that robots need to comply with existing laws and fundamental rights and freedoms; that robots are products so that they should ensure safety and security; and that they should not be deceptive. In relation to those principles, the EPSRC identified seven crucial bring-home messages. Among them, the most important ones are: to address obvious public concerns will help all make progress; to work with experts from other disciplines including social sciences, law, philosophy and the arts; and that bad practice hurts all.

In 2012, a 27-month European funded project called “Regulating Emerging Robotic Technologies in Europe: Robotics Facing Law and Ethics” began. The aim of the project was to offer an analysis of the ethical and legal issues raised by robotic applications and to provide regulators with guidelines to deal with them²³⁶. They

²³⁰ Available at: www.prnewswire.co.uk/news-releases/world-robot-declaration-from-international-robot-fair-2004-organizing-office-154289895.html

²³¹ The abstract of the application can be found at www.euron.org/activities/projects/roboethics.

²³² Available at: www.roboethics.org/atelier2006/docs/ROBOETHICS%20ROADMAP%20Rel2.1.1.pdf

²³³ All the information is extracted from their open website www.epsrc.ac.uk/research/ourportfolio/themes/engineering/activities/principlesofrobotics/.

²³⁴ See Sharkey, N. (2007) Robot wars are a reality. The Guardian. Available at: www.theguardian.com/commentisfree/2007/aug/18/comment.military

²³⁵ Campaign launched in London. More information at: www.stopkillerrobots.org/2013/04/campaign-launch-in-london/

²³⁶ D 6.2. “Guidelines on Regulating Robotics”, RoboLaw project, p. 8.

focused on the intersection between Law and robotics. The Robolaw project sustained that robotic technology could challenge the European Constitutional Framework, and put at risk various foundations of the constitutional legal order, such as dignity, human integrity, equality, freedom of thought, good administration, privacy, cultural/religious/linguistic diversity, data protection, access to healthcare, non-discrimination or fair working conditions²³⁷.

In 2017, the European Parliament took into account all the experts opinions and configured its final resolution with several recommendations to the European Commission for a *lege ferenda* on Civil Law Rules on Robotics²³⁸. The Parliament expects the Commission to produce a regulation on the use of robotic technology foreseeable in 10-15 years. This report was confirmed and concretized by another report from October 2016²³⁹, and by the European Commission in February 2017²⁴⁰.

Both the Robolaw project and the resolution from the European Parliament are our starting point, as they are the only legal bodies that specifically addressed personal care robots.

3. Current Legal and Ethical Framework for Personal Care Robots

The final guidelines of the RoboLaw project identified 6 different legal themes that, in their words, were most likely to have a general bearing on the broad field of robotics²⁴¹:

- 1) Health, safety, consumer and environmental regulation;
- 2) Liability;
- 3) Intellectual property rights
- 4) Privacy and Data Protection;
- 5) Capacity to perform legal transactions; and
- 6) Protection of fundamental rights.

The project aimed at translating these general threats to the legal framework into a more detailed analysis focusing on different technologies: autonomous driving, surgical robots, prosthetics, and care robots. The care-robot chapter (which is our main focus) included a legal analysis according to which they recommended that care robots should respect fundamental rights, independence and autonomy in the light of independent living and participation in community life, equality and access, liability and insurance, privacy, and the legal capacity and legal acts performed by robots. In the ethical side, they mentioned some issues concerning safety, responsibility, autonomy, independence, enablement, privacy, social connectedness, new technologies and justices, and new technologies, ethics and scientific research. These

²³⁷ See B-J. Koops et al. "Robotic Technologies and Fundamental Rights. Robotics Challenging the European Constitutional Framework" Int J Tech Ethics, 4(2), 2013, pp. 15-35

²³⁸ See the 2015/2103(INL) Resolution on Civil Law Rules on Robotics (May, 2016). Available at: www.europarl.europa.eu/sides/getDoc.do?pubRef=-//EP//NONSGML+COMPARG+PE-582.443+01+DOC+PDF+V0//EN

²³⁹ The European Parliament's Committee on Legal Affairs, Policy Department for "Citizens' Rights and Constitutional Affairs Study on European Civil Law Rules in Robotics of October 2016 available at: [www.europarl.europa.eu/RegData/etudes/STUD/2016/571379/IPOL_STU\(2016\)571379_EN.pdf](http://www.europarl.europa.eu/RegData/etudes/STUD/2016/571379/IPOL_STU(2016)571379_EN.pdf)

²⁴⁰ See European Parliament news from 12 Jan 2017: www.europarl.europa.eu/news/en/news-room/20170110IPR57613/robots-legal-affairs-committee-calls-for-eu-wide-rules

²⁴¹ This list is meant not to be exhaustive, although it appeared like this in the project.

aspects were based on another European project, Robot-Era²⁴². Then they provided a framework of normative suggestions in order to regulate personal care robots and their interactions with humans.

We have grouped these principles, even if a very simplistic manner, in Table 2. Following sub-sections include a brief literature review on the state of the art concerning these aspects and (personal care) robots.

Principle	Explanation
Safety	For users and third parties
Consumer robotics	Health, consumer protection, environmental regulation
Liability	General and prospective liability
User's rights	Privacy, data protection and intellectual property rights
Autonomy	Independence, final say, acceptance
Dignity	Non-replacement of human touch or emotions, non-replacement of human caregivers, isolation
Ethics	Robot decision-making process in open scenarios
Justice	Access to technology

Table 3 Principles involved in the regulation of robotics²⁴³

a. Safety

Oxford dictionary defines safety as the “condition of being protected from or unlikely to cause danger, risk or injury”. Risk, on its side, is defined by “ISO 12100:2010 General Principles for Design – Risk Assessment and Risk Reduction” as the “combination of the probability of occurrence of harm and the severity of the harm”.

The most general framework for safety involving robots quoted by the legal literature is the three laws of robotics of Isaac Asimov's²⁴⁴:

- (1) A robot may not injure a human being or, through inaction, allow a human being to come to harm.
- (2) A robot must obey the orders given by human beings, except where such orders would conflict with the First Law.
- (3) A robot must protect its own existence as long as such protection does not conflict with the First or Second Laws

Although originally three from Runaround in 1942, in 1986, a fourth law (that would be the zeroth law) was introduced by the same author in the Foundation of Earth:

- (0) A robot may not harm humanity, or, by inaction, allow humanity to come to harm.

Although part of the science fiction, this framework has been taken very seriously until now, e.g. in 2016 the European Parliament suggested that the Laws of Robotics (making reference to Asimov's laws) “must be regarded as being directed at the

²⁴² See www.robot-era.eu/robotera/

²⁴³ Fosch-Villaronga, E. and Roig, A. (2017) op. cit.

²⁴⁴ Leenes, R., & Lucivero, F. (2014). Op. cit.

designers, producers and operators of robots, since those laws cannot be converted into machine code”²⁴⁵.

Concerning safety, the researchers of the Robolaw project highlighted the fact that the right to physical integrity is a right under the European Charter of Fundamental Rights (EU CFR). They enounced that the contact between human and robot is not always clear, and that the safety requirements, protective measures and safety related control requirements are open issues regardless of the fact that ISO 13482:2014 focuses on the conditions for physical human-contact in personal care robots that can lead to a hazardous situation (a risk scenario).

In fact, ISO 13482:2014 focuses either on the robot’s side, e.g. standardizing robot’s spatial behavior in response to human presence, the robot’s noise level in human environment, its perception in HRIs, the establishment of some generic and some high-priority commands for HRI or even the differences between gestures across several cultures²⁴⁶; and on the user’s side, e.g. avoiding musculoskeletal disorder, fatigue, discomfort, injuries, blunt force trauma, etc²⁴⁷. The idea is to have a Human-Robot Safe Interaction (HRSI) when there is “zero distance between robot and an object in its external environment” in words of the ISO either if it is allowed (permitted by the manufacturer) or unintended.

b. Consumer Robotics

There are some authors that have started calling the part of consumer law that refers to robots “Consumer Robotics”. Consumer robotics addresses questions concerning fraud and deception but also about data protection of robots²⁴⁸. Hartzog argues that the American Federal Trade Commission (FTC) uses the deceptive trade practice to protect consumers from misleading products. According to this author, deception can relate to the expectations of the consumers or to the tele-operation of robots (e.g. Wizard-of-Oz, WoZ, setup. Hartzog argues that 1) communications 2) organizational procedures and 3) design are the three crucial concepts for safe robots. He also believes that the FTC could be a good choice to deal with this technology because FTC defers industrial standards, avoids dramatic regulatory lurches and cooperates with other agencies.

In Europe, European directives define the essential requirements to ensure a high level of protection of health, safety, consumer protection, or the protection of the environment. Such directives under the new approach are based on Article 114 of the Treaty on the Functioning of the European Union (ex Article 95 TEC), which allows for the adoption of measures for the improvement of free movement of goods. Because personal care robot standard complements ISO 12100:2006 (revised in 2010) on safety machinery, the closest directive to ISO 13482:2014 is Directive 2006/42/EC of the European Parliament and of the Council of 17 May 2006 on Machinery. After the creation of the personal care robot standard, however, the directive remained unclear on whether safety of these robots is covered in the robots’ scope or not.

In any case, the machinery directive is part of the “new approach” directives that, although implemented in 1985, promote harmonization through a combination of

²⁴⁵ Apart from the fact that these laws are science fiction, this statement is very controversial: there are actually groups working on how to code harm in Hannover, Germany. See chapter 5.

²⁴⁶ Robotics 2020 Multi-Annual Roadmap. For Robotics in Europe. Call 2 ICT 24 Horizon 2020, SPARC, 2015, p. 287.

²⁴⁷ ISO 13482:2014 “Robots and Robotic Devices – Safety Requirements for Personal Care Robots”

²⁴⁸ Hartzog W (2015) Unfair and Deceptive Robots. We Robot, at: www.werobot2015.org/wp-content/uploads/2015/04/Hartzog-Unfair-Deceptive-Robots.pdf

mandatory health and safety requirements, and voluntarily harmonized standards between the European legislator and the European Standard bodies²⁴⁹. This type of approach sets out levels of protection but does not state which means should be adopted to achieve such levels.

Personal care robots are regulated in this case and up to now by standards. The task of drawing up the corresponding harmonized standards meeting the essential requirements of products established by the directives is entrusted to the European standardization organizations: European Committee for Standardization (CEN), European Committee for Electrotechnical Standardization (CENELEC) and European Telecommunications Standards Institute (ETSI). However, does the personal care robot compliance with standard imply the compliance with the directive? Products that comply with harmonized European standards (EN) are presumed to meet the corresponding essential requirements (presumption of conformity, CE marking). Consequently, Member States accept the free movement of such products²⁵⁰. In this case, after the personal care robot standard has been cited in the Official Journal of the European Union under that Machinery Directive and it has been implemented as a national standard in at least one Member State, compliance with the normative clauses of this standard confers, within the limits of the scope of the standard, a presumption of conformity with the relevant Essential Requirements of that Directive and associated EFTA regulations²⁵¹.

As a very important remark, the presumption of compliance does not happen in the United States: the compliance with the American National Standards Institute (ANSI) is only a mean of complying with the Occupational Safety and Health Administration (OSHA) standards, that are binding pieces of legislation²⁵², but it is not a presumption of compliance²⁵³. ISO 13482:2014 was prepared under a mandate given to CEN by the European Commission and the European Free Trade Association to provide one tool of conforming to essential requirements of the Machinery Directive. The text of ISO 13482:2014 was approved by CEN as EN ISO 13482:2014 without any modification, which means that it now has the presumption of conformity.

c. Liability

Responsibility, liability and accountability are different²⁵⁴. The Black's Law Dictionary defines *responsibility* as the “obligation to answer for an act done, and to

²⁴⁹ see http://ec.europa.eu/growth/sectors/mechanical-engineering/machinery_en

²⁵⁰ More information about CE Marking: <https://cemarking.net/using-standards-to-comply-with-the-essential-requirements-of-the-ce-directives/>

²⁵¹ You can read this information in the Irish adoption of the ISO 13482:2014, from the National Standards Authority of Ireland (NSAI) .

²⁵² see <https://www.osha.gov/law-regs.html>. There is also a European OSHA, look: <https://osha.europa.eu/en>

²⁵³ see again http://www.robotics.org/userassets/riauploads/file/TH_RIA_Roberta_Nelson_Shea.pdf

²⁵⁴ In the majority of the Latin languages, for instance, these three concepts are expressed through the same word, for instance, *responsabilitat* (Catalan) *responsabilité* (French), *responsabilità* (Italian), *responsabilidad* (Spanish), *responsabilidade* (Portuguese), *responsabilitate* (Romanian). It is true that in Catalan, Spanish and French the word “accountability” in some cases could be translated slightly different (*rendició de comptes*, *rendición de cuentas*, *rendition des comptes*), as well as in Romanian the word liability can be translated into *răspundere*; but, generally speaking, they are used as indifferently. Of note, we do not try to dig in the notion of responsibility as others have done such as Dworkin, R. (1981) What is Equality? Part 2: Equality of Resources. *Philosophy and Public Affairs* 10: 283-345; Cohen, G. A. (1989) On the Currency of Egalitarian Justice. *Ethics* 99: 906-44; Arneson, R. (1989) Equality and Equal Opportunity for Welfare. *Philosophical Studies* 56, pp. 79-95; Dworkin, R. (2000) *Sovereign Virtue: The Theory and Practice of Equality*. Cambridge: Harvard University Press; Roemer, J. (1996) *Theories of Distributive Justice*. Cambridge: Harvard University Press.

repair any injury it may have caused”. This definition refers to the state of having a duty to deal with something or someone, like a mother for her child²⁵⁵. Dworkin argues that it is to act with due diligence and that non-compliance could lead the society to claim for consequences²⁵⁶. When this responsibility is a legal requirement, that is to say when someone is bound or obliged by the law (in other words, legal responsibility), this is called *liability*²⁵⁷. *Accountability* is defined by Oxford Dictionary as “required or expected to justify actions or decisions” and normally refers to the party that “must report activities and take responsibility for them”²⁵⁸. As explained in the Black’s Law Dictionary, this is to keep the party honest and responsible. Professor Kool summarizes this threesome in a very simple manner: “accountability follows responsibility, whereas accountability aims at establishing liability”²⁵⁹. As she points out, however, liability and accountability are not synonymous with responsibility. But, what do all these concepts mean when we are talking about robots and artificial intelligence?

For the Robolaw project, the introduction of a care robot in a healthcare facility arises questions on liability (potential damage to a patient, medical practitioner or equipment) but also to agency, needing to determine who is in control at any time. They argue that nowadays the development risk defense for product liability should be considered under Article 7 (e) of the European directive 85/374/CE on the approximation of the laws, regulations and administrative provisions of the Member States concerning liability for defective products. According to this article: “The producer shall not be liable as a result of this Directive if he proves (...) that the state of scientific and technical knowledge at the time when he put the product into circulation was not such as to enable the existence of the defect to be discovered”.

In 2014 Johnson argued that the concept of responsibility in the robot domain was still underdeveloped²⁶⁰. Johnson explains that the major positions on this domain - the so-called *responsibility gap* on the one side, and the human responsibility for robot actions on the other side - do not normally dig into the real meaning of responsibility of an artificial agent. She believed that in reality, the responsibility gap did challenge neither responsibility nor liability concepts, but the accountability. With the growing use of impact assessments in the European Union, it is clearer that the creation of autonomous robotic technology has considerably challenged accountability.

The discourse on responsibility and robots is strictly linked to the autonomous behavior of robots. If a robot processes data and performs a task for the user autonomously, who is responsible for any adversity? What if the robot does something different from what it was programmed? The capacity of robots to act autonomously and the capacity to learn autonomously from experience (i.e. machine learning) challenge the traditional responsibility framework. Arthur Samuel defined machine learning as “the field of study that gives computers the ability to learn without being explicitly programmed”. More recently, scholars from Carnegie Mellon University have explained that machine learning tries to understand how to build computer

²⁵⁵ Oxford Dictionary.

²⁵⁶ See Dworkin, R. (2011). *Justice for hedgehogs*. Harvard University Press.

²⁵⁷ The Black’s Law dictionary defines liability as *the state of being bound or obliged in law or justice to do, pay, or make good something*; and quotes different judgements from diverse supreme courts in the United states: *Wood v. Currey*, 57 Cal. 209; *McElfresh v. Kirkendall*, 36 Iowa, 225; *Benge v. Bowling*, 100 Ky. 575, 51 S. W. 151; *Joslin v. New Jersey Car-Spring Co.*, 36 N. J. Law, 145.

²⁵⁸ Black’s Law Dictionary op. cit.

²⁵⁹ See Kool, R. S. (2014). (Crime) Victims’ Compensation: The Emergence of Convergence. *Utrecht Law Review*, 10(3), 14-26.

²⁶⁰ Johnson, D. G. (2015). Technology with No Human Responsibility?. *Journal of Business Ethics*, 127(4), 707.

systems that automatically improve with experience, and what are the fundamental laws that govern all these learning processes²⁶¹. On the other side, the European Parliament defines robot's autonomy as the ability to take decisions and implement them in the outside world, independently of external control or influence.

This autonomous behavior of robots led some authors to believe that there was a gap in the current responsibility framework²⁶², including the European Parliament²⁶³. As explained by Matthias, the responsibility gap theory suggests that, if robots learn as they operate, and the robots themselves can, in the course of this operation, change the rules by which they act, then there is no reason why humans should be held responsible for the autonomous behaviors of the robot. On the contrary, robots are the ones that should be held responsible for their autonomous decisions (*see* Fig. 30). Prof. Dr. Scheutz at Tufts University during summer 2016 explained that when a person kills someone, both action and intention were taken into account to claim criminal responsibility. However, it is not clear who is responsible if both the action and the intention are automated²⁶⁴. The allocation of responsibility to an autonomous robot furthermore raises the question on the meaning of agent, i.e. should robots be granted some sort of agentialhood/personhood due to the fact that they might be held responsible for their autonomous behavior in the future? Autonomy, responsibility and agentialhood seem to be correlated in this domain (*see infra*) although currently robots are not legal entities and, thus, cannot be held responsible.

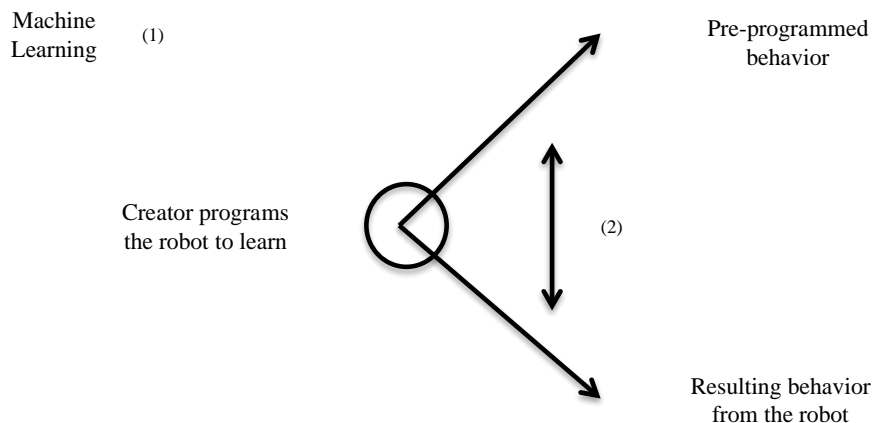

Figure 17 Machine Learning (1) and the Responsibility Gap

Although EPSRC said clearly in 2010 that the responsible agents are the humans and not the robots and although not being fully addressed by the Robolaw project, Chopra and White argued that the more autonomous electronic agents become, the

²⁶¹ See Mitchell, T. M. (2006). The discipline of machine learning. Carnegie Mellon University, School of Computer Science, Machine Learning Department. Available at: www-cgi.cs.cmu.edu/~tom/pubs/MachineLearningTR.pdf

²⁶² See Matthias, A. (2004). The responsibility gap: Ascribing responsibility for the actions of learning automata. *Ethics and Information Technology*, 6(3), 175–183.

²⁶³ The European Parliament argues on its report that “robots’ autonomy raises the question of their nature in the light of the existing legal categories – of whether they should be regarded as natural persons, legal persons, animals or objects – or whether a new category should be created, with its own specific features and implications as regards the attribution of rights and duties, including liability for damage”

²⁶⁴ Matthias Scheutz was referring to the famous paper about autonomous weapon systems of Robert Sparrow. See Sparrow, R. (2007). Killer robots. *Journal of applied philosophy*, 24(1), 62–77.

more lawyers should accept that minor changes to law cannot be the solution²⁶⁵. Indeed, big part of the juridical community believes that if agents (robots in our case) are capable of deciding on their own, they should be adjudicated some sort of juridical relevance, i.e. some sort of agenthood²⁶⁶. At this respect, the European Parliament does believe in the existence of a responsibility gap. They clearly state “the ability to learn from experience and take independent decisions – has made them [robots] more and more similar to agents that interact with their environment and are able to alter it significantly; whereas, in such a context, the legal responsibility arising from a robot’s harmful action becomes a crucial issue”. The Parliament also admits that, *rebus sic stantibus*, in the current legislative framework it would be impossible to held responsible robots.

Other opinions are in contrast with the responsibility gap²⁶⁷. These opinions normally go in line with the strict liability regime, that is, when a person/entity is held liable regardless of the culpability element²⁶⁸; or with the existence of professional codes of conduct, values and ethical standards that establishes a “professional responsibility” that would prevent roboticists from creating uncontrollable robots²⁶⁹.

In line to this professional responsibility, Johnson highlights that the creation of new technologies involves 1) persons that decide on the creation of these technologies and 2) people that accept these decisions. According to her assumption, the responsibility gap refers to the scenario where the persons involved in the creation of a robot have decided to create a technology that is uncontrollable, and that the society (consumers especially) has accepted the fact that there is no human responsibility for this uncontrollable robot. As Santoro argued that, not because the creator decides on the creation of uncontrollable machines, people necessarily would accept no human responsibility²⁷⁰. In fact, when a technology acts in an unexpected way²⁷¹, e.g. when the Google photos’ algorithm labeled black people with gorillas²⁷² or when the YouTube Kids ended up at not being at a safe place for young children²⁷³, the first

²⁶⁵ S. Chopra and L. White, (2004) Artificial Agents - Personhood in Law and Philosophy, in Proceedings of the 16th European Conference on Artificial Intelligence, pp. 635-9.

²⁶⁶ This topic was already wondered by Solum in 1992. Although he believed that at that point that was just a theoretical question, he wondered whether artificial intelligence could become finally a legal person. In fact, one of the first times this started being a serious discussion was in the realm of electronic transactions, also quoted by Chopra and White op. cit. See the Uniform Electronic Transactions Act (1999) Section 14: Automated Transaction: In an automated transaction, the following rules apply: (1) A contract may be formed by the interaction of electronic agents of the parties, even if no individual was aware of or reviewed the electronic agents’ actions or the resulting terms and agreements. (2) A contract may be formed by the interaction of an electronic agent and an individual, acting on the individual’s own behalf or for another person, including by an interaction in which the individual performs actions that the individual is free to refuse to perform and which the individual knows or has reason to know will cause the electronic agent to complete the transaction or performance. (3) The terms of the contract are determined by the substantive law applicable to it. Available at: www.uniformlaws.org/shared/docs/electronic%20transactions/ueta_final_99.pdf.

²⁶⁷ See Santoro, M. et al. (2008). Learning robots interacting with humans: from epistemic risk to responsibility. *AI and Society*, 22(3), 301–314; or, in the same edition, Nagenborg, M., et al. (2008). Ethical regulations on robotics in Europe. *AI and Society*, 22(3), 349–366

²⁶⁸ It is worth mentioning the *Escola v. Coca Cola Bottling Co.* (1944) 24 C2d 453 case, see: online.ceb.com/CalCases/C2/24C2d453.htm

²⁶⁹ Nagenborg op. cit.

²⁷⁰ See Santoro, M. et al. (2008). Learning robots interacting with humans: from epistemic risk to responsibility. *AI and Society*, 22(3), 301–314.

²⁷¹ For further information, see Chander, A. (2016). *The Racist Algorithm?*. Michigan Law Review, 2017.

²⁷² Baar, A. (2015) Google Mistakenly Tags Black People as ‘Gorillas,’ Showing Limits of Algorithms at the Wall Street Journal blogs.wsj.com/digits/2015/07/01/google-mistakenly-tags-black-people-as-gorillas-showing-limits-of-algorithms/.

²⁷³ This video shows some of the content that might not be appropriate for children under the YouTube Kids: vimeo.com/127837914. See Baar, A. (2015) Google’s YouTube Kids Criticized for “Inappropriate Content”

thing to wonder is who is to blame (regardless of the release of this technology). As Johnson explains, people not only expect that certain behaviors will not happen again, but certainly ask for something to be done in order to ensure it. In other words, people want to know who is accountable.

Johnson admits that, because robots are normally built and used by many people it might be very difficult to know in the future who should be accountable for them. In fact, and taking into account the second (2) scenario above-mentioned, she believes that future generations will have two choices: either accept technologies with no human responsibility or attribute accountability to each of the contributors of the robot chain. According to Johnson “the responsibility gap depends on human choices not on the complexity of the technology”.

Other authors argue that responsibility is strictly related with self-consciousness, and that only in the case that future robotic technologies could develop such characteristic they might be granted personhood²⁷⁴; others believe that it is possible to grant agenthood to an artificial agent. Still, the legal doctrine is not clear on how to deal with the new actor status²⁷⁵. Teubner believes that Law has already welcomed new agents in the legal system in the past, e.g. electronic agents and animals, and that depending on the chosen doctrinal construction, the legal consequences (protection of the agent, responsibility for the behavior of the agent) would be different.

Similarly, Laukyte argues that we have already witnessed the extension of rights to other entities such animals (through the theory of self-consciousness or as Darling explained through the theory of anthropomorphism²⁷⁶), and corporations (like the free of speech of corporations²⁷⁷). Laukyte argues that there is no reason why in the future we could not extend rights to robots²⁷⁸ and so does Darling. Following the theory of self-consciousness, Laukyte reports the example of the work of Scassellati. Scassellati created a humanoid robot with similar self-awareness capabilities of humans, in fact – already in 2007 – this robot was able to recognize itself in a mirror²⁷⁹. Laukyte also mentions the theory of pain, that is, we protect animals because they feel pain. Although seeming impossible, there are already researchers trying to teach robots how to feel and recognize the pain²⁸⁰. Could we think in the future that, if robots are able to feel pain, they are also going to be recognized agenthood?

Although Laukyte and Darling seem to be in favor of the extension of legal rights to robots (although from different theories), this seems to be done from the defensive institution’s point of view: robots need to be protected against abuse. Indeed, Teubner argues that when the society has identified animals as new agents, it has done it to

at the Wall Street Journal, blogs.wsj.com/digits/2015/05/19/googles-youtube-kids-app-criticized-for-inappropriate-content/.

²⁷⁴ Koops, B. J. et al. (2010). Bridging the accountability gap: Rights for new entities in the information society?. *Minnesota Journal of Law, Science & Technology*, 11(2), 497-561.

²⁷⁵ Teubner, G. (2006). Rights of non- humans? Electronic agents and animals as new actors in politics and law. *Journal of Law and Society*, 33(4), 497-521.

²⁷⁶ Darling (2016) op cit.

²⁷⁷ Massaro, T.M. and Norton, H. (2016) op. cit.

²⁷⁸ Laukyte, M. (2013). The capabilities approach as a bridge between animals and robots. Available at: cadmus.eui.eu/bitstream/handle/1814/27058/MWP_2013_05.pdf?sequence=1&isAllowed=y

²⁷⁹ Although M. Laukyte (2013) op. cit. quotes Hart and Scassellati (2012), the actual work she is referring to is Gold, K., and Scassellati, B. 2007. A bayesian robot that distinguishes “self” from “other”. In Proceedings of the 29th Annual Meeting of the Cognitive Science Society (CogSci2007). See in any case, also Hart, J. W., & Scassellati, B. (2010, January). Robotic Self-Models Inspired by Human Development. In *Metacognition for Robust Social Systems*.

²⁸⁰ See Kuehn, J., & Haddadin, S. (2016). An Artificial Robot Nervous System To Teach Robots How To Feel Pain And Reflexively React To Potentially Damaging Contacts. *IEEE Robotics and Automation Letters*, 2(1), 72-79.

protect them against abuses²⁸¹. Teubner believes, on the contrary, that electronic agents (and by extension robots) create an aggressive productive institution from which society needs to be protected. In other words, Teubner believes that society needs to be protected from these new agents instead of protecting them²⁸².

In both cases, the risks associated with the harm occurrence will be assessed differently. Teubner explains plainly (even if referring to computers) that if a robot is seen as the human person's property, a malfunctioning could be seen as a mistake in the calculation and probable treated as irrelevant. Thus, the owner would be strictly bound to the contract with no possibility to rescind the contract. The problem here is when the robot's malfunctioning harms a human. Koops argues that the responsibility goes strictly related with self-consciousness²⁸³. However, whether machines will develop or not consciousness seems a distant scenario. As Johnson said, it is to society to decide how we approach this.

To finish this section, just mention that when Johnson explains the scenario of the responsibility arrangements (i.e. whether the society will accept technology with no human responsibility or not) she uses a very futuristic scenario. She argues that maybe in the future machines will have to explain what they did wrong and why they did so. In fact this scenario might not be that far away from reality: one of the biggest problems that current roboticists have is actually how to trace back the behavior of a robot. In other words, sometimes the robot behaves in an unexpected way and roboticists do not know exactly why. In the future not only the use of black boxes but also the use of explanatory arguments from the machine could be very helpful for users and judges to know exactly what went wrong. Other authors believe that technology should be designed to ensure human responsibility²⁸⁴. In fact, this could go in line with what we mentioned about the US Department of Defense: future technology will be focused less on robot autonomy and more on supporting human decision-making²⁸⁵.

d. User Rights

Calo stated, "Unlike ordinary store clerks, however, robots are capable of recording and processing every aspect of the transaction. Face-recognition technology permits easy re-identification. Such meticulous, point-blank customer data could be of extraordinary use in both loss prevention and marketing research"²⁸⁶. Similarly, the

²⁸¹ He concretely says: "Animal rights and similar constructs create basically defensive institutions. Paradoxically, they incorporate animals in human society in order to create defences against destructive tendencies of human society against animals". And this is perfectly in line with what Darling argues in her op. cit.

²⁸² Teubner op. cit. goes: "For electronic agents, the exact opposite is true. Their legal personification, especially in economic and technological context, creates aggressive new action centers as basic productive institutions. Here, their inclusion into society does not protect the new actors, just the opposite, it is society that needs to defend itself against the new actors".

²⁸³ Koops, B. J., et al. (2010). Op. cit.

²⁸⁴ See Cummings, M. L. (2004). Creating moral buffers in weapon control interface design. *Technology and Society Magazine, IEEE*, 23(3), 28–33; and Cummings, M. L. (2006). Automation and accountability in decision support system interface design. *Journal of Technology Studies*, 32(1), 23–31.

²⁸⁵ U.S. Department of Defense (2012). Task force report: The role of autonomy in DoD systems. See www.fas.org/irp/agency/dod/dsb/autonomy.pdf. This tendency was already envisaged by Johnson, M., et al. (2011). The fundamental principle of coactive design: Interdependence must shape autonomy. *Coordination, organizations, institutions, and norms in agent systems VI*. Heidelberg: Springer, when they argued that "We no longer look at the primary problem of the research community as simply trying to make agents more independent through their autonomy. Rather, in addition, we strive to make them more capable of sophisticated interdependent joint activity with people".

²⁸⁶ Calo, R. (2012) *Robots and Privacy*. In: Lin, P. et al. (2012) *Robot Ethics: The Ethics and Social Implications of Robotics*. Cambridge, MA: MIT Press

researchers from the Robolaw project mention that personal care robots can mutate function and form by the insertion of other devices such as electronic devices or ambient assisted living technologies. They affirm that the processing of sensitive information of the users would imply a greater risk for privacy than the monitoring systems in nursing homes.

There has been a lot of discussion on whether the right to privacy and the data protection right are the same or not in Europe²⁸⁷. In 2016, Koops wrote a comprehensive survey stating that both rights are two sides of the same coin²⁸⁸. He believes that although both rights have been distinguished one from another, the truth is that the scope of the right to privacy is very large and includes not only data protection (that could be called “informational privacy” depending on the legal order) but also other eight types of privacy: bodily, spatial, communicational, proprietary, intellectual, decisional, associational and behavioral (see next figure). They are all interrelated.

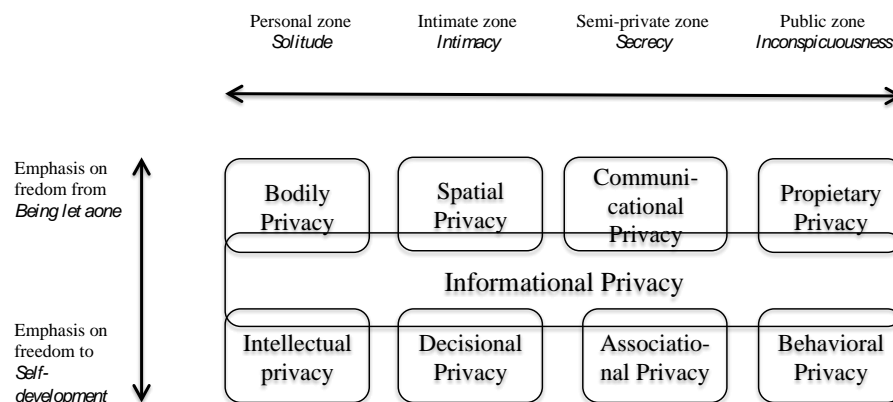

Figure 18 Extracted from the A typology of Privacy work from Koops et al.

As the “Privacy and emerging fields of science and technology: Towards a common framework for privacy and ethical assessment (PRESCIENT)” project mentioned, privacy is a multifaceted concept that needs to be justified²⁸⁹. Koops et al. justify all these concepts by stating that:

- **Bodily privacy** refers simply to avoid being touched by others, and involves the freedom of body movement
- **Spatial privacy** is the protection of the privacy of people in relation to the places where they enact their private life, not only home. It refers to the privacy of accessing the place, and controlling its use.

²⁸⁷ J. Kokott and C. Sobotta (2013) The Distinction between Privacy and Data Protection in the Jurisprudence of the CJEU and the ECtHR. *International Data Privacy Law*, 3:4, pp. 222-228. See also P. Hustinx (2013) Ethical Dimensions on Data Protection and Privacy. European Data Protection Supervisor (EDPS)

²⁸⁸ Koops, B. J. et al. (2016). A Typology of Privacy. *University of Pennsylvania Journal of International Law*, Forthcoming.

²⁸⁹ One can read “one should provide reasons that explain why privacy deserves to be achieved or/and to be protected”. See *Privacy and emerging fields of science and technology: Towards a common framework for privacy and ethical assessment. Deliverable 1: Legal, social, economic and ethical conceptualizations of privacy and data protection.*

- Communicational privacy is restricting the access or controlling the information communication to third parties
- Proprietary privacy refers to using property as means to shield activity, facts, things or information.
- Intellectual privacy protects the cognitive aspects of people, normally related to the development of opinions and beliefs.
- Decisional privacy concerns the intimate decisions. Koops refers to sexual orientation basically.
- Associational privacy is basically the power of the person to interact with whoever we want to. This sphere is semi-private as normally these interactions happen outside of the personal space.
- Behavioral privacy is the privacy that refers to the behavior of the person in public visible activities.
- Informational privacy according to Koops is an overlapping concept that prevents anyone from collecting information about one-self.

The Robolaw project suggests some rights to be put in place for personal care robots, those are: the right not to use personal care robots, the treatment and storage of personal data should be limited and the surveillance should only proceed in cases of vulnerable health of a user. Privacy will also have to be modeled by default, as requested by the new European 2016/679 Regulation on Data Protection (GDPR)²⁹⁰. The Privacy-by-Design (PbD) is a concept developed by Cavoukian in the 1990s and was born under the idea that the mere compliance with regulations cannot guarantee the protection of privacy, but the inclusion of this philosophy in the organization's modus operandi can do it. Although there is no concrete guidance to the data controller²⁹¹, this principle is binding after the GDPR. This principle will oblige the data controller (and in this case the roboticists) when planning data processing to implement appropriate measures for ensuring that all the requirements of the regulation are met. This implementation will need to be pro-active, like a default setting, embedded into the design, with a full functionality, offering a full lifecycle protection, open and user-centric²⁹² Although not relieving from responsibility, a voluntarily certification issued by the National Data Protection Authority (art. 42 GDPR) is going to be able to be asked in order to demonstrate compliance with these requirements.

As the Robotics Annual 2020 Roadmap Robotics in Europe establishes, the technology in the following years will be combined. That is why they mention the possibility to access to cloud data processing, as well as to the internet of things. In the end, there will be an integrated healthcare sensing that will provide valuable data for decision-making systems. This will challenge other rights of the GDPR such as the right to be forgotten, the right that allows the deletion of the entire subject's data and obliges the controller to do it. Moreover, the controller is responsible for informing third parties that are processing this data by means of links, copies, or replications [...] ²⁹³. There are some authors that believe that the right to be forgotten challenges

²⁹⁰ Regulation (EU) 679/2016 on the protection of natural persons with regard to the processing of personal data and on the free movement of such data. This corpus will enter in force in 2018.

²⁹¹ J. van Rest et al., (2012) Designing privacy-by-design. Springer Berlin Heidelberg, 55-72

²⁹² A. Cavoukian, 7 Foundational Principles of Privacy by Design, (2011).

²⁹³ Article 29 Working Party, Opinion 01/2012 on the data protection reforms proposals, adopted in March 23rd 2012.

machine learning algorithms²⁹⁴. If robots are in a system that include machine learning capabilities, this will be a challenge to be solved.

e. Autonomy

Autonomy is identified by Koops et al. as part of privacy, as there is not a recognized autonomous right in the EU CFR²⁹⁵. On their side, the Robolaw project makes a difference between autonomy and independence: whereas the principle of autonomy refers to the ability of the user to make their own decisions concerning personal care, independence is the ability to manage ADL and satisfy personal needs by oneself.

The Robolaw project affirms that the right to independent living expressed in the Art. 19 of the United Nations Convention on the Rights of Persons with Disabilities is the right behind the capacity to decide on someone's care. They also mention that independence could be challenged by the use of personal care robots because an increase on their use would imply dependence on them. They also believe that the domiciliation of care provoked by the use of personal care robots, could imply a lack of social connectedness. This would entail a disengagement from the human carers although the participation in social and cultural life are fundamental rights in Europe (Art. 25 and 26 EU CFR). Referring to autonomy, the researchers stress the fact that robots do not replace human care, but become human companions.

Although not referring to robots, the upcoming GDPR mentions a very important right: the right not to be subject to a decision based solely on automated processing, including profiling (Art. 22 GDPR). As robots will be processing vast amounts of data, they will be subject to this right although there is yet no research connecting robots and this right from the data protection legislation.

f. Dignity

The European Parliament mentioned in their draft that the robotic revolution could softly impact on human dignity, and that, although this impact could be difficult to estimate, it would have to be considered if and when robots replace human care and companionship²⁹⁶. This is because the inclusion of care robots can decrease human care and thus human contact²⁹⁷. This can affect not only the dignity of the user (the care-receiver) but also the ones that implement this technology (the caregiver).

g. Ethics

Referring to enablement, the researchers believe that the introduction of personal care robots does not challenge the basis of human nature but that they do challenge “the social and political conditions that determine the rights and the culture of our commitment to the weakest members of society”²⁹⁸.

²⁹⁴ Malle, B., Kieseberg, P., Weippl, E., & Holzinger, A. (2016, August). The right to be forgotten: towards machine learning on perturbed knowledge bases. In *International Conference on Availability, Reliability, and Security* (pp. 251-266). Springer International Publishing.

²⁹⁵ In fact, the word “autonomy” is not even mentioned in the Charter: www.europarl.europa.eu/charter/pdf/text_en.pdf

²⁹⁶ See the 2015/2103(INL) Resolution on Civil Law Rules on Robotics (May, 2016). Available at: www.europarl.europa.eu/sides/getDoc.do?pubRef=-//EP//NONSGML+COMPARL+PE-582.443+01+DOC+PDF+V0//EN

²⁹⁷ Clark, R. A. et al. (2007) Telemonitoring or structured telephone support programmes for patients with chronic heart failure: Systematic review and meta-analysis. *British Medical Journal*, 333, p. 942

²⁹⁸ Deliverable 6.2. Guidelines on Regulating Robotics, op. cit. p. 175.

As reported by Salem et al., the risks associated with robots can also have ethical implications²⁹⁹. However, there are currently no legally binding frameworks or guidelines on the creation of robotic technology that could approach ethical implications. The only corpus addressing this issue is “BS 8611: Robots and robotic devices – Guide to the ethical design and application of robots and robotic systems”, which was recently published. BS 8611 has identified broad range of ethical hazards and their mitigation including societal, application, commercial/financial and environmental risks. Concerning societal hazards, the concepts of deception, privacy, confidentiality, addiction, loss of trust and employment are also addressed.

The European Parliament suggests that a guiding ethical framework should be based on the principles of beneficence, non-maleficence and autonomy, as well as on the principles enshrined in the EU Charter of Fundamental Rights, such as human dignity and human rights, equality, justice and equity, non-discrimination and non-stigmatization, autonomy and individual responsibility, informed consent, privacy and social responsibility, and on existing ethical practices and codes.

h. Justice

The Robolaw project sustains that personal care robots are not still essential for public healthcare system and that if they are adopted by private income in the future, this would enlarge the existing wealth discrimination gap and affect the principle of justice.

In 2015, the Accessibility Act promoted by the European Commission suggested, “an environment where products and services are more accessible allows for a more inclusive society and facilitates independent living”³⁰⁰. The scope of the Accessibility Act does not include “access to healthcare technology”, which is a sensible prerequisite to get access to the recognized services. In any case, the principle of access should be understood both in cost – affordable technology – and in opportunity: everyone should be given the opportunity to benefit from robotic technology if this is beneficial for their health.

The European Group on Ethics in Science and New Technologies (EGE) mentioned that there should be a requirement to contribute to e-literacy. In the case of robot technology, and due to the non-acceptance rates in the European Union, more efforts should be done in the education of the population regarding the benefits of this robotic technology. This not only would help increase the acceptance from the elderly, but it also would help avoid misuse or even the creation of autonomous weapon systems – from young users.

In their draft report, the European Parliament mentioned that researchers in the field of robotics should think about the fair distribution of the benefits of their technology as well as the affordability of their systems – in particular healthcare robots

²⁹⁹ Salem M. et al. (2015) Towards Safe and Trustworthy Social Robots: Ethical Challenges and Practical Issues. In: Tapus, A. et al. (eds.) (2015) ICSR, LNAI 9388, pp. 584-593

³⁰⁰ 2015/0278 (COD) European Commission Proposal of a Directive on the approximation of the laws, regulations and administrative provisions of the Member States as regards the accessibility requirements for products and services

4. Problems Associated with the current legal and ethical framework for personal care robots

Up to now it is still not clear what ethical, legal and social (ELS) framework should be used in robotics. Salvini identifies several opinions in his work³⁰¹; Coeckelbergh defends the use of the capability approach in ethics of information technologies; others like Datteri et al. think that attention should be drawn to those charters that protect fundamental rights (like the EU CFR); and others like Feil-Seifer et al. think that ELS should be framed under the principles of medical ethics (beneficence, non-maleficence, autonomy and justice). What is clear is what these approaches have in common, that is, the fact that they are top-down approaches and they refer normally to civil law countries.

The latest European documents on Law and Robots are also top-down approach. In 2012 a group of researchers drafted a green paper on the legal issues in robotics, and decided to use a top-down approach. They mapped all the existing legislations to analyze afterwards their impact on case studies. For instance, they considered autonomous cars as the same topic as legal issues in automotive; or they considered privacy issues in assistive robotics as a particular case of privacy issues with computers³⁰². The Robolaw project seemed to offer more concretization *prima facie* because it addressed different types of robots, but they did not conduct any field study and their conclusions are rather vague. In fact, the top-down approach has been normally used for ethically appropriate actions, they is largely criticized for their unsuitability, as they provide a general theory of intelligent action³⁰³.

The green paper does not explain what top-down approach means, but it does discard the bottom-up approach for four main reasons:

- 1) First, it presents the risk to forget some legal issues.
- 2) Second, there is the risk of fragmentation of the problem.
- 3) The third reason why they discard the bottom-up approach is that it “may drive to miss commonalities within robotics and with other technological disciplines”.
- 4) The fourth and the last reason is that “a bottom-up approach is time demanding”.

We believe on the contrary that:

- 1) Concrete cases offer a realistic idea of how technology works, and what are the problems associated with it.
- 2) The fragmentation of the problem facilitates the identification of the legislations involved in a particular risk scenario.
- 3) Only by knowing the concrete cases one can truly know what are the similarities and dissimilarities between the devices.
- 4) We cannot put the protection of the users at stake at the expenses of time constraints.

³⁰¹ Salvini, P. (2015) On Ethical, Legal and Social Issues of Care Robots. In S. Mohammed et al. (eds.)(2015) Intelligent Assistive Robots, Springer, pp. 431-445

³⁰² These are exact words of the green paper, page 8. See Leroux, C., et al. (2012). Suggestion for a green paper on legal issues in robotics. Contribution to Deliverable D, 3(1) on ELS issues in Robotics.

³⁰³ Allen, C., Smit, I., & Wallach, W. (2005). Artificial morality: Top-down, bottom-up, and hybrid approaches. *Ethics and Information Technology*, 7(3), 149-155.

Producing recommendations and guidelines without field study can only result in a future miscommunication between concerned stakeholders. A larger perspective of the legal issues could satisfy policymakers needs, but it could also make lose concreteness of the framework (useful for creators) and imply a heavy use of interpretation and analogies (which roboticists are not used to). Moreover, a drone and a care robot might differ on their capabilities to fly, but they might challenge privacy in a very similar way.

Last but not least, complex systems may require complex analysis. The analysis of particular cases is time consuming but disregarding their analysis for this reason might be contrary to current European trends, i.e. the use of impact assessments for privacy and surveillance matters. Independently of whether it is or not a job of the regulator (because it would be public time and cost consuming) we cannot undermine its importance for compliance, accountability, and even for future policies matters³⁰⁴.

This complexity was not addressed by the Robolaw project. The Robolaw project acknowledged the great variety of devices and did a report analyzing different types of robots (autonomous cars, prosthesis and care robots) but it never went deep into the precise robot categories or the technical aspects of them. They argued that “It is not a robot’s intrinsic technical quality or characteristic alone that calls for regulation, and the ability of the robot to operate autonomously, and even its ability to learn and adapt its functioning do not per se suffice in justifying a change in perspective. The robot is still an object a product, a device, not bearing rights but meant to be used” and that only “if society is to favor or pose some limits to technological development, then the technical aspects of the individual robotic device need to be taken into account”³⁰⁵.

In 2012, however, already 65% of the European population interviewed in a Eurobarometer wanted to ban the use of robots for care matters³⁰⁶. In 2015, 29% of the contestants stated that they would feel comfortable having a robot provide service to infirm people. In fact, the level of “total uncomfortable” decreased by 9%³⁰⁷. Although the more than half of the population interviewed disagreed with the insertion of robots into the care system already in 2012, technical aspects were not dealt in the Robolaw project.

At the beginning of 2017, there are not still guidelines on care robots. The only document with *lege ferenda* status is the resolution of the parliament of May 2016. The European Parliament calls for an individual legislation for care robots under the idea that the insertion of robots could dehumanize caring practices, when in reality the human contact has been found as a fundamental aspect of human care. Individual regulations for autonomous vehicles, medical robots, human repair and enhancement, and drones are also called for proposal.

A robot that promotes human-human interaction, however, does not aim at substituting human care, but transforming it in a way humans have not been able to do up to know. Care robots could promote human social interaction – a mobile servant that helps autistic children socialize – or could physically help humans gather together, with an exoskeleton for instance. In fact, the dehumanizing process could happen not to come from the robot itself, but from its given use (by researchers, caregivers, users).

³⁰⁴ Fosch-Villaronga, E. and Heldeweg, M.A. (2017) op. cit.

³⁰⁵ See The presentation of the Robolaw project at Robohub: robohub.org/robolaw-why-and-how-to-regulate-robotics/

³⁰⁶ See Special Eurobarometer 382’s report on Public Attitudes Towards Robots, Wave EB77.1 – TNS Opinion & Social (2012).

³⁰⁷ See the Eurobarometer 427 on Autonomous Systems (2015).

The robot could also, of course, substitute some human functions due to its capabilities, or due to the technology applied to it.

Seeing the complexity of the robot functionalities, and in the lack of clear legal guidance, there is miscommunication between both the creators of the robots and lawmakers. While the creators need to be compliant with the Law, but are clueless about what are the aspects to take into account in their creations; the lawmakers lack the technical knowledge and are divided between those who believe the robot law falls under the fallacy of the law of the horse, and those who consider that robots do challenge the legal system and thus, a response should be given. This situation forces roboticists, most of the times, to *try first and ask for forgiveness later*. A thorough assessment of the impacts associated with this technology – either positive or negative – could be used to know, therefore, what are the pros and cons of this technology. This information can benefit both regulatory bodies, for policymaking purposes; and robot creators, for compliance purposes.

5. Risk Management Methodology Applied to Legal Matters

This thesis is an attempt to systematically combine both aspects (top down and bottom up approaches) to solve the problems personal care robots present. Within the Commission's Smart Regulation Strategy, impact assessments are considered to be “transparently assessing legislative and non-legislative policy options by comparing both potential benefits and costs in economic, social and environmental terms [...] performed for all proposals with significant direct impacts [...] been issued for analyzing impacts on fundamental rights [...]”³⁰⁸.

In other words, IAs are processes that point out the impacts of new projects, technologies, services or programs and, in consultation of the main stakeholders, they take remedial and corrective actions to eschew or mitigate any risks³⁰⁹. The definition of risk is strictly related to the concept of safety, which is “the minimization of risk and epistemic uncertainty associated with unwanted outcomes that are severe enough to be seen as harmful”³¹⁰. The application of the risk methodology in Law promotes communication between the involved stakeholders and takes into account other aspects normally left aside in safety regulations: economic, social, ethical, psychological or financial aspects. In short: interdisciplinary regulations for interdisciplinary problems. Furthermore, this risk-based approach goes beyond a simple harm-based-approach that focuses only on damage but includes every potential as well as actual adverse effect³¹¹.

Considering the usefulness of this smart and interdisciplinary process to manage risks, it is not surprising that there is a wide range of IAs for different types of regulations: Privacy Impact Assessments (PIA), Surveillance Impact Assessments (SIA), Health Impact Assessments (HIA), Environmental Impact Assessments (EIA),

³⁰⁸ See COM(2012) 746 Final: Communication from the Commission to the European Parliament, the Council, the European Economic and Social Committee and the Committee of the Regions. EU Regulatory Fitness. Available at: eur-lex.europa.eu/LexUriServ/LexUriServ.do?uri=COM:2012:0746:FIN:EN:PDF.

³⁰⁹ Inspired by the definition given in Wright, D.; Wadhwa, K. A Step-by-step Guide to Privacy Impact Assessment. II PIAF Workshop. Poland (2012).

³¹⁰ N. Mo ller, “The concepts of risk and safety,” in Handbook of Risk Theory, S. Roeser, R. Hillerbrand, P. Sandin, and M. Peterson, Eds. Dordrecht, Netherlands: Springer, 2012, pp. 55–85

³¹¹ See Number 11 of WP128 Statement op. cit.

etc³¹². In fact, conducting a privacy impact assessment, for instance is mandatory under the Art. 35 GDPR. It seems a specific risk requires a specific instrument to deal with it. There are no impact assessments for precise types of technology, i.e. for robots, which could be involved in several of these impacts. There is either a Robot Agency for roboticists to be accountable in front of it (and potentially in front of users). However, the latest movements of the European Institutions in 2017 might change this reality³¹³.

At the moment, however, the only way to address different risks is to conduct several impact assessments. PIA for instance basically deals with the privacy impacts that a given technology will pose to the subjects³¹⁴. According to the CNIL, “in the area of privacy, the only risks to consider are those that processing of personal data pose to privacy”³¹⁵. On the other hand, SIA as a wider instrument, is principally concerned with other impacts (not only privacy, but also economic, financial or psychological impacts), and focuses on groups and not individuals as PIA does³¹⁶. A robot could challenge nevertheless privacy and be involved in surveillance scenarios; but also cause damage that does not correspond to a human error, if a person entails a relationship with a robot if the employment of robot technology entails an incredible unemployment rate, the human emotions’ projection to the machines or the morality of robotic servants³¹⁷. The use of a PIA or a SIA for personal care robot technologies would increase the knowledge of the impact on these aspects – privacy and surveillance – but would offer partial knowledge on what other risks these robots pose to society, and, therefore, fall short on providing solutions for other risks.

If a specific instrument seems to be needed, how, then, should it look like? Wright and De Hert largely studied how impact assessment methodologies could be used in data protection contexts³¹⁸. They wondered whether impact assessment methodologies should be mandatory, because Privacy Impact Assessments (PIAs) are in opposition to the idea of reducing regulatory burden, imply additional costs and impose restriction to the free power of stakeholders. In 2018, the Art. 35 GDPR will make them mandatory. There is also currently the ISO/IEC 29134 Privacy Impact Assessment Guidelines under development to explain what is the scope of it. In 2012, Wright and Raab envisioned the application of the same methodology for surveillance matters. They sustained the need for a wider instrument that focused on the impact of surveillance systems on other fields rather than only privacy: economics, finance, sociology and psychology. The development of a European project on the development of a Surveillance Impact Assessment³¹⁹ and the fact that three years later researchers

³¹² For these four last categories of Impact Assessments, it is worth further reading the report ‘Four Types of Impact Assessment Used in Canada’ made by National collaborating Centre for Healthy Public Policy (2010).

³¹³ On January 12th 2017 the Committee on Legal affairs approved the European Parliament document on Civil Rules for Robots, *see* www.europarl.europa.eu/committees/en/juri/home.html

³¹⁴ SGTF *op. cit.* and ISO 27005:2011, “Information Technology – Security Techniques – Information Security Risk Management”

³¹⁵ CNIL, *op. cit.* (2012) “Methodology for Privacy Risk Management. How to Implement the Data Protection Act,” Commission Nationale de l’Informatique et des Libertés, CNIL.

³¹⁶ Wright and Raab *op. cit.*

³¹⁷ D.Y.Y. Sim and C.K. Loo, “Extensive Assessment and Evaluation Methodologies on Assistive Social Robots for Modeling Human-Robot-Interaction – A Review,” *Information Science* vol. 301, 2015, pp. 305-344

³¹⁸ Wright, D., & De Hert, P. (2012). *Privacy Impact Assessment*. Springer Netherlands.

³¹⁹ *See* all the information at the Sapient project: www.sapientproject.eu

are already testing it³²⁰ indicate that the use of impact assessments in other contexts is a feasible reality.

6. Risk Management Methodology Applied to Personal Care Robots

Although both instruments – PIA and SIA – could be used to deal with robotics – because they process great amount of information and because they have turned into new ways of citizenry surveillance – the novelty and complexity of the technology makes it difficult to understand the risks and impacts associated with it. The specificity of the technology and its specific context of use calls for a new instrument capable of identifying, understanding and mitigating all its connected impacts:

- Care robot technology might have impact on each of the types of privacy described by Koops et al., from bodily privacy (assistants) to behavioral privacy (carriers) or decisional privacy (servants)³²¹. This includes a huge impact on data protection (informational privacy).
- These robots might impact the integrity of the user, either physical or mental because it interacts with the user very closely both physically and cognitively (even emotionally);
- At the same time, the autonomous decision-making process of care robot technology challenges the current liability regime (responsibility gap) and the concept of agent;
- The use of these robots might undermine the dignity of the user;
- The massive use of personal care robot technology might have an impact at the social level, e.g. high rates of unemployment. This can have multiple side effects: the education of the population, a decrease on the human-human interactions, the revival of the concept “slave”, the overreliance on the robot decision-making process, etc.
- Care robots raise, at the same time, many ethical questions: Is the care shifting from a personalized to a depersonalized status, or are both conditions maintained at the same time? Are robots delivering a good care? To what extent physical assistant robots can improve human’s abilities? Is human dignity properly considered and safeguarded? Which are the activities that humans can (or should) delegate to machines? What happens when a machine enhances a patient’s sanity? Can robots cause patient’s distrust and denial to access medical care?

An assessment that could clarify the impacts of this technology and the obligations of the roboticists could help produce safer technology. This is important because currently standardized evaluation criteria and clear effectiveness and safety evaluations for care robots are missing³²². There are not protocols of use of this technology either, although we do have protocols for the appropriate use of airplanes. A bridge between the abstract general principles that conform the robot legal

³²⁰ See Wright, D., Friedewald, M., & Gellert, R. (2015). Developing and testing a surveillance impact assessment methodology. *International Data Privacy Law*, 5(1), 40-53.

³²¹ Koops, B. J., et al. (2016) op. cit.

³²² See Tucker, M. R. et al. (2015). Control strategies for active lower extremity prosthetics and orthotics: a review. *Journal of neuroengineering and rehabilitation*, 12(1), 1, who talk about the cognitive aspects too.

framework to the concrete formulation of technical rules seems to be missing³²³. An ethical framework for the evaluation of this type of robotic technology was presented by van Wynsberghe in 2012.³²⁴ The framework stimulates ethical reflection of designers creating a care robot, encourages ethical reflection from the care ethics tradition and elucidates the relationship between the technical aspects of the care robot and the expression of care values within care practices. The promotion of care values within the design of care robots goes in line to what Coeckelberg highlighted time ago, that is, whether those who design, use and control this kind of robots should also be required moral agency and emotion³²⁵. Although pioneer in the field³²⁶, this framework lacks nonetheless a connection with the current juridical system.

To not only align the design of robots with care values, but also promote juridical compliance, in this work we ideated, the Robot Impact Assessment for personal care robots – alias Care Robot Impact Assessment (CRIA). CRIA is a methodology to identify, analyze and mitigate the risks posed by the insertion of personal care robots in the legal and ethical domain³²⁷. This integrated process represents a guidance to developers of robot technology – in this case care robots – to identify, in any step of their creation process (idea, concept, prototype, pre-launch, launch, post-launch³²⁸) potential legal and ethical issues that have not occurred to them before and that might not be in any specific regulation they have been using as assessment for their devices. This can be used for compliance purposes, avoid further liability scenarios and ultimately create safer technology.

CRIA is based on the general risk management ISO 31000:2009 Risk Management – Principles and Guidelines. Accordingly, “all activities of an organization involve risk” and “Organizations manage risk by identifying it, analyzing it and then evaluating whether the risk should be modified by risk treatment in order to satisfy their risk criteria”³²⁹. However, ISO 31000 is just a general risk framework that only gives some principles, establishes the main framework and provides a general overview of the risk management process. That is why other concrete specific aspects have been dealt with separately, in other bodies like PIA, SIA, and the Environmental Impact Assessment (EIA).

In our case, the first two steps of our integrated process are: first, the identification of the context of use of the technology; and second, type of the technology used, i.e. the robot type and its characteristics. These two first steps are going to be easily conducted by the roboticists themselves, because they are the ones deploying the technology and, most of the cases (especially if they are in research) also implementing it.

The third step consists in identifying the legal and ethical risks linked to the particular technology. This might not be as obvious as the first two steps, as it would

³²³ In a similar way although referring solely to the protection of privacy, see Koops, B. J., & Leenes, R. (2014). Privacy regulation cannot be hardcoded. A critical comment on the ‘privacy by design’ provision in data-protection law. *International Review of Law, Computers & Technology*, 28(2), 159-171.

³²⁴ Van Wynsberghe, A. (2013). op. cit.

³²⁵ Coeckelbergh, M. (2010). Moral appearances: emotions, robots, and human morality. *Ethics and Information Technology*, 12(3), 235-241

³²⁶ This initiative seem to have been followed by others such as the British Standard 8611:2016 on the ethical design of robots (www.bsigroup.com/en-GB/about-bsi/media-centre/press-releases/2016/april/-Standard--highlighting-the-ethical-hazards-of-robots-is-published/) or the IEEE ethically aligned designed (see standards.ieee.org/develop/indconn/ec/ead_brochure.pdf).

³²⁷ Fosch-Villaronga, E. (2015) op. cit.

³²⁸ Jespersen, K.R. (2008). *User Driven Product Development: Creating a User-Involving Culture*. Samfundslitteratur.

³²⁹ ISO 31000:2009, Risk Management – Principles and Guidelines

require knowledge on certain areas – the legal and the ethical – that might not be familiar to the developers of such technology. It might not be that clear either in the legal domain which aspects should be taken into account in the development of their technology. That is why this thesis tries to systematically address this step, combining technical and contextual information with the already identified legal issues the state of the art offers – in this case, the chapter on care robots of the Robolaw project, the prevision of care robots of the European Parliament’s *lege ferenda* resolution and relevant literature and legislation. This includes the guidelines the industry has provided so far for personal care robots – ISO 13482:2014 (*see* next figure).

The fourth step consists in identifying possible the solutions to the arisen (negative) impacts. A thorough analysis of the scenarios including a particular legal and ethical risk will help identify the solutions to be applied to mitigate problems. Most of the times developers and creators of the technology know better how to deal with arisen legal issues than legal experts, simply because legal experts may not understand how technology works³³⁰. Indeed, developers and creators sometimes have very practical solutions, from putting a stick on someone’s personal laptop camera to prevent privacy infringement, or removing the camera and the gps to navigate with the drone³³¹.

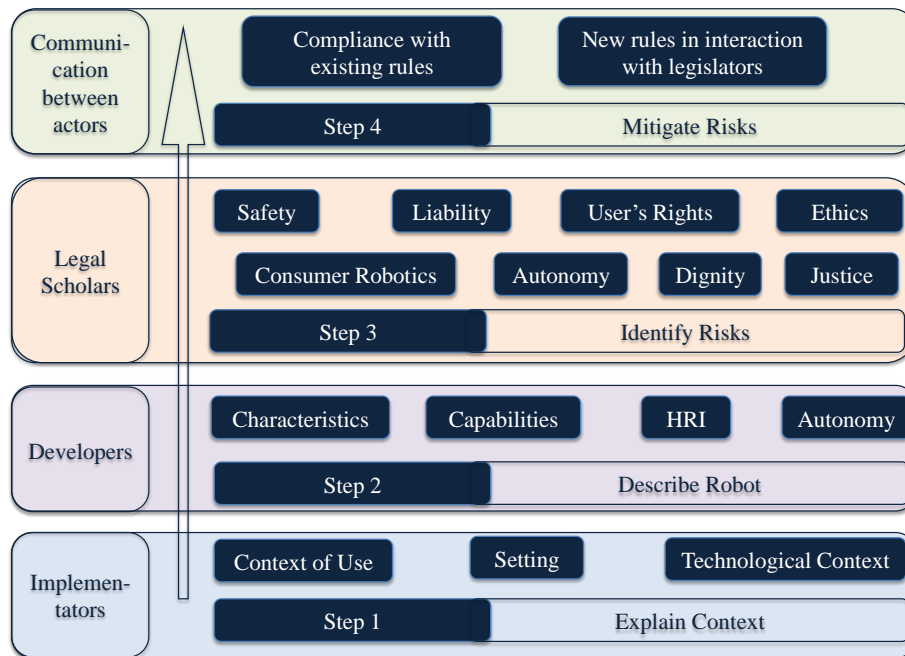

Figure 19 Robot impact assessment for personal care robots

This iterative and integrative process promotes the integration of legal and ethical aspects into the development of robotic technology that interacts closely with humans. It has a special focus on healthcare, which is why dignity and ethics play a major role in the analysis. This can help the accountability process as other instruments/agencies

³³⁰ Kooops, B. J., & Leenes, R. (2014) op. cit.

³³¹ Ph.D. Student Ryo Konomura developed an unmanned aerial vehicle called Phenox2 which flies autonomously with a fixed flight program decided by the owner. *See* <http://asia.nikkei.com/Tech-Science/Tech/Tiny-autonomous-UAV-flies-without-GPS>

have already made steps forwards in other domains, in data protection for example³³². The completion of such analysis also brings clarity on the legal aspects linked to a particular technology, which remains uncertain at the moment because there is not such an instrument that deals with a particular type of technology. The process – here below better explained – suggests that there should be a joined effort along the process between developers and legal practitioners to conduct such an assessment. This is important to avoid the anxiety that normally legal compliance creates to non-legal experts, because it is not their area of expertise. Moreover, it would make it easier to identify possible gaps or constraints from the regulatory side that could be compiled and sent to the competent authority to ask for a comment or an explanation.

Over time, and if this methodology could be further developed a “Robot Seal” could be ideated, i.e. a certification that shows to users and interested parties that the robot in question follows with the latest regulations at this regard³³³. For the moment, this certification process seems to be far from existing, as well as roboticists believe that all this may hamper their innovation while, in reality, a robot seal would work as the biological products work: although products follow stricter regulations, there is a market for it that grows every year³³⁴.

5.1. First step: Explain the Context

In order to concretely know the impacts that the personal care robot has on the citizens it is important to study the context where this robot will be inserted. The context of use, the setting, and the technological context play a crucial role on determining what are the legal boundaries that shape the development and the use of the robot.

(1) Context of use: For instance, the regulation that applies to a robot might change depending on whether it is inserted in a military context, used for rehabilitation or in an industrial assembly. In the next figure we can see different exoskeletons that are used in different domains. Exoskeletons used in rehabilitation contexts, for instance, are medical devices because they have a medical purpose as defined by the European Commission³³⁵ or by the FDA in United States³³⁶. In the case of a research context, projects normally need the approval of the Institutional Review Board (IRB), the consent of the participants of the project, etc. If the product has not been marketed yet, then certain procedures do not apply, like the CE marking rules.

³³² In 2015, the strategy of the European Data Protection Supervisor (EDPS) included “be accountable and promote accountability” and explained in a meeting that the accountability is the shift from “responsibility” to “enhanced responsibility”. Available all the information at the Annual Report of the EDPS of 2015. *See* secure.edps.europa.eu/EDPSWEB/webdav/site/mySite/shared/Documents/EDPS/Publications/Annualreport/2015/EDPS_Annual_Report_2015_Web_EN.pdf. *See* also all the questionnaires related to this fact at secure.edps.europa.eu/EDPSWEB/webdav/site/mySite/shared/Documents/Supervision/Accountability/16-06-06_accountability_questions_EN.pdf

³³³ This could work as the European Privacy Seal that is a certification that shows the compliance with the European Regulatory Framework. *See* www.european-privacy-seal.eu/EPs-en/Home

³³⁴ This market grows every year, at least in U.S., considerably according to the Organic Trade Association (OTA). *See* graphic statistics at <https://www.ota.com/resources/market-analysis>

³³⁵ European Commission (1994) Guidelines relating to the application of the council directive 90/385/EEC on active implantable medical devices and the council directive 93/42/EEC on medical devices. Ref. MEDDEV 2.1/1 Medical Device Guidance Document.

³³⁶ FDA defines it as “A powered exoskeleton is a prescription device that is composed of an external, powered, motorized orthosis used for medical purposes that is placed over a person's paralyzed or weakened limbs for the purpose of providing ambulation”. *See* www.accessdata.fda.gov/scripts/cdrh/cfdocs/cfPCD/classification.cfm?ID=PHL



Figure 20 From left to right, Panasonic Assist Suit³³⁷, HULC (Berkeley Robotics)³³⁸ and HAL (Cyberdyne)³³⁹

(2) **Setting:** Concerning the institution, and to achieve optimistic results the impact assessment needs to be integrated as an essential part of the company/institution's management process. To do this, both the internal and the external contexts should be considered, as they both can affect the development and use of personal care robots. Regarding the internal context, the institution needs to consider: its own structure (whether it is a nursing home, a hospital, a rehabilitation center, or a sports facility), the main objectives of the robot (medical purpose or not), roles of the persons involved, decision-making processes (of the institution, of the robot, etc.), distribution of responsibilities, etc. Regarding the external context, the institution should take into account what expectations external stakeholders (users, third-parties, companies) have, contracts with other undertakings³⁴⁰, etc. According to van Wynsberghe, other aspects will have to be taken into account, like different wards within a hospital or whether the institution is religious or not.³⁴¹

(3) **Technological Context:** By “technological context” we refer to the technical architecture that supports the communication between the devices. This architecture could include a LAN network, a wireless LAN (Wi-Fi) connection, and a cloud platform (private, public or hybrid). This architecture could support also wearable devices, ambient assisted living technologies. Depending on the infrastructure behind the devices implemented in a particular context, general principles of the law – privacy or autonomy – could be greatly challenged. This could entail a translation of the decision-making process: from humans to machines (*see* following chapters). The technological context could be very important for dependency aspects (whether the robot is dependent of a continuous reliable connection) or also concerning the digital divide, i.e. whether developing countries will have access to such technologies if they are deprived from internet access.

³³⁷ See <http://news.panasonic.com/global/stories/2016/44969.html>

³³⁸ See www.lockheedmartin.com/content/dam/lockheed/data/mfc/pc/hulc/mfc-hulc-pc-01.pdf

³³⁹ See <http://www.cyberdyne.jp/english/products/HAL/>

³⁴⁰ We will see in the following chapters that not only it is going to be important to know what are the contracts that the company has with other companies (for instance, a hospital that buys some exoskeletons and hires the services of the selling company) but also if those other companies have other contracts with other companies, because they are processing the data for instance (in the case of the Barbie Talk, and as we will see in chapter 3, the company sends the information of the user to improve the speech recognition). This is relevant because some clauses in the contract with these third-party exclude any responsibility for the processing of personal data of this other company; which can, on the contrary, undermine the rights of the user.

³⁴¹ Van Wynsberghe (2013) op. cit.

5.2. Second Step: Describe the Robot Type and Characteristics

Although all service robots are in non-industrial environments and require close HRI, they largely differ between them depending on their attributes, capabilities, HRI or the contexts where they are inserted. Having a general framework for “personal care robots” could help differentiating them from drones or autonomous cars. As we will see, however, there is the need to create a framework that can recognize the specificities of each of the sub-types of personal care robots because, within this category, devices do large differ between them.

Generally speaking, depending on the type of robot that will be inserted in the institution, risks will vary substantially. For instance a segway® will have all the person-carrier-robot associated risks (mainly navigation errors); whereas a physical assistant robot, which can be fastened to the body, could provoke a direct physical damage to the user. Moreover, even within the person-carrier-robot category, a case-by-case assessment is needed: wheeled passenger carriers, segways or beds that transform into wheelchairs are all different (*see* chapter 4).

Therefore, the characteristics of the robot should be identified (hardware, software, network of transmission). Also the level of HRI should be defined (merely physical; physical but in a symbiotic manner with the user’s body; purely cognitive; a relationship rather than a mere sporadic interaction, etc.). The actors of interaction should be analyzed (patients, children, third parties), the level of autonomy of this robot (teleoperated, semi-autonomous, autonomous), who is in charge of it (the hospital, or the patient who purchased it and used it in the same facilities, etc.) and the extension of the use of the robot (if later on the robot is used in the dwelling of the patient but it still communicates with the hospital, for instance; or if the robot is basically meant to be used in indoor contexts but it can be used in outdoor too).

A robot impact assessment analyzes all these aspects minutely. Of course this is a complex process as it aims to group together particular risks and solutions for each kind of personal care robot; nevertheless, it will be easier to inform future policies governing robotic technologies that take into account the wide spectrum these technologies have (not only concerning their technical aspects, but also their HRI and capabilities). The more knowledge we have about the technology, the better we can address the risks associated to them.

5.3. Third Step: Identify Risk Scenarios

Identifying impacts and risks is of crucial importance. This identification process can be held when carrying out the impact assessment, because of external/internal audits or because the institution has developed a culture of enhanced responsibility³⁴². The identification process will normally be based on a stakeholder and legal-expert consultation. These can identify the vulnerabilities of the system and the legal boundaries. These risks could be identified in a testing zone or a living lab. Although current living labs are not connected with the compliance process of new robot developments, this could change in the near future³⁴³.

The goal in this phase is to identify feared events like the confusion of a drink bottle with a cleaning product, the loss of free will in the autonomous decision-making

³⁴² The European Commissions refers to the *culture of privacy* in the context of data protection. In our case, not only a culture of privacy should be developed but a general awareness of the risk that new robots can pose to the patients, children or disabled people. But, any way, see Ann Cavoukian op. cit.

³⁴³ Eskelinen, J. et al. (2015). Citizen-Driven Innovation – A Guidebook for City Mayors and Public Administrators. European Network of Living Labs (ENoLL).

process, the possibility to fall down with an exoskeleton due to a navigation error, or the psychological impacts of the replacement of the human touch by robotic care. These impacts can be classified in broader categories so that focus groups are created to deal with a particular risk. In this work, the categories have been built upon the Robolaw project main categories, which include safety, consumer robotics, liability, privacy, autonomy, dignity, ethics and justice.

These risks feature technological, legal and ethical aspects and that is why the framework governing them should be multifold. A technical answer, for instance the inclusion of communication capabilities to a wheeled passenger carrier, can be a solution to the psychological effect of the decrease in the human-human interaction (which could imply a cognitive safety issue and a risk for the mental health of the users on the other hand). What is important is to be pro-active when it comes to legal and ethical compliance.

Depending on the degree of uncertainty, complexity and ambiguity, there are initiatives that promote the use of a risk analysis according to the precautionary principle, that is, to be “prudent [...] of response in the face of uncertainty”³⁴⁴. The European Parliament encouraged the designers to analyze the predictability of a human-robot system by considering uncertainty in interpretation and action, and possible robotic or human failure³⁴⁵. In addition, they also supported the idea that, when it is impossible to eliminate a risk, the precautionary and the proportional principles should apply³⁴⁶.

5.4. Fourth Step: Mitigate the Identified Risks

The robot impact assessment should be best carried out before the risk occurrence³⁴⁷. After having identified and analyzed the risk, this will have to be mitigated, by using “Best Available Techniques (BATs)” for instance. This technique refers to the most effective and advanced stage in the development of activities and their methods of operation, and provides the basis for complying with EU ruling³⁴⁸. This approach was originally for the EU data protection framework, and designed to prevent or mitigate risks on privacy, personal data and security. However, this idea can be applied for robots extending its scope to a wider compliance spectrum idea. This could help protect the users’ rights, although the robots received the appropriate certification³⁴⁹.

There are several strategies to treat the risks: (1) risk avoidance (which could imply creating a separate infrastructure for robots, i.e. elevators or corridors); (2) risk reduction (the risk could be reduced by applying the protective measures provided by safety standards such as the ISO 13482:2014; (3) risk transfer (there might be the case that in the future people will hire an insurance companies to cover those risks that cannot be covered by the creator of the robot, as the European parliament suggested); (4) risk retention (acceptance of the risk without further action). In this work, we have

³⁴⁴ Renn, O., and Stirling, A. (2004). Op. cit.

³⁴⁵ European Parliament Resolution op. cit. page 18.

³⁴⁶ Suggesting also that the risk of harm should be no greater than that encountered in ordinary life.

³⁴⁷ Even if different topics, also the RRI report op. cit. says that “The risks, concerns and uncertainties of new technologies oftentimes are considered only at a late stage, often just before market introduction”, page 13.

³⁴⁸ 2012/148/EU Commission Recommendation of 10 October 2014 on the Data Protection Impact Assessment Template for Smart Grid and Smart Metering Systems.

³⁴⁹ In the following chapters we will be talking about the differences between certified safety and perceived safety, which is the basis of this argumentation.

focused more on the risk reduction, on how could the identified risks be reduced by applying safeguards.

According to different criteria (normally related to efficiency and effectiveness), the creator will choose whatever is more convenient. The most important thing anyway is to have an appropriate control to each identified risk. Sometimes one control will mitigate multiple risks. It does not matter if controls are technological and affect legal risks: this intertwining will ensure complete compliance. Moreover, there is the need to accept the residual risk after implementing those controls³⁵⁰. In that case, some safeguards and complementary protective measures to assess the best solution to mitigate the risk can be envisaged.

To all this, this process should be consulted all the time. ISO 31000 defines consultation and communication as “continual and iterative processes that an organization conducts to provide, share or obtain information and to engage in dialogue with stakeholders regarding the management of risk”. In this case, the stakeholders could be the persons in charge of the development of the robot, but also the users and the regulatory bodies, perhaps the future European Robot. This way there could be a continuous consultation, feedback and amelioration of the robot according to the laws and the expectations of the ones involved, and, at the same time, maybe the laws could be updated more easily thanks to the developers that push towards experiments that do not fit in the current regulatory system.

³⁵⁰ Residual risk is defined by ISO 27005:2011 as ‘the risk remaining after the risk treatment’.

3. Chapter - Analysis of Non-Social Personal Care Robots

PART A: Person Carriers

My disability exists not because I use a wheelchair, but because the broader environment is not accessible. Stella Young.

1. Person Carriers Robots: Wheeled passenger carriers

The current section is about “wheeled passenger carriers” (*see* Fig. 1). Of course, there are other types of person carriers, but they are too futuristic (like the two-leg passenger carrier) or they suffered a market failure when they hit the market³⁵¹. Although the annex D of ISO 13482:2014 provides examples of functional tasks of these robots, there is no evidence that legged passenger carriers or carriers whose passenger sits on a monocyte are being deployed. There are two examples of these robots – i-Foot model from Toyota³⁵² and the U-3X from Honda³⁵³; both companies have not produced them in a mass scale. We did not analyse passenger standing on the foothold because there has been not much coverage on them, as it has happened with segways (they are trendy and there a lots of tours being made with this technology), especially when have been involved in some accidents³⁵⁴.



Figure 21 Wheeled Passenger Carrier. Extracted from ISO 13482:2014.

Therefore, we focused on wheeled passenger carriers. Their name already poses an interesting question and some kind of confusion: are they actually wheelchairs? This confusion is provoked by different facts:

³⁵¹ Even if it great expectations, the IT project (alias Segway) has not hit the market. *See* content.time.com/time/specials/packages/article/0,28804,1898610_1898625_1898641,00.html and *see* the documentary on Netflix called “Slingshot” from 2014.

³⁵² See the first chapter for more information. In any case, visit: www.toyota-global.com/innovation/partner_robot/aichi_expo_2005/index03.html

³⁵³ Ibidem: U3-X Honda Source: world.honda.com/U3-X/

³⁵⁴ Roeder, D. et al. (2015). Segway® related injuries in Vienna: report from the Lorenz Böhler Trauma Centre. *European journal of trauma and emergency surgery*, 1-3.

1. It is hard to avoid wheelchair identification when we are talking about “wheeled passenger carrier”. In fact, a wheelchair is also a wheeled passenger carrier.
2. Terminology is still developing and currently it is not consistent across research and regulatory stakeholders³⁵⁵.
 - a. The International Federation of Robotics defines personal service robot or a service robot for personal use (which ISO 13482:2014 identified as “personal care robots”) as follows: “a service robot used for a non-commercial task, usually by lay persons. Examples are domestic servant robot, automated wheelchair, personal mobility assist robot, and pet exercising robot”³⁵⁶. So, IFR would include wheelchairs as “service robot for personal use”.
 - b. Dinwiddie in a very recent book about “Basic Robotics” introduces the new ISO 13482:2014 on personal care robots, and states “Personal carrier robots are devices that take people from point A to point B. Robotic wheelchairs and self-driving vehicles fall into this sub-category”³⁵⁷; which would mean that part of the literature recognize this fact.
 - c. When Panasonic Global News Exclusive described its robot Resyone (the first robot in the world to obtain the certification of personal care robots), they said that “Resyone is a robotic device built on an entirely new concept which fuses an electric care bed with an electric reclining wheelchair. Part of the electric care bed detaches off to serve as the electric reclining wheelchair, thus allowing the user to easily transfer from bed to wheelchair without placing burden on the caregiver. With Resyone, only one care giver is require to support safe and simple transfer between bed and wheelchair, thus lightening the load for care givers and making it easier for care receivers to get out of bed whenever they desire”³⁵⁸. Although this robot was addressed by the mobile servant criteria (*see infra*), the inclusion of it as personal care robot could make one believe that wheelchairs are part of this standard.

It could be argued that one of the reasons why these devices are out of the scope of the personal-care standard, however, is the explicit exclusion of medical devices from the scope of ISO 13482:2014. As a counterargument, although manual wheelchairs are medical devices class I, motorized wheelchairs are class II and stair-climbing devices are class III³⁵⁹; robotic wheelchairs are not yet considered medical devices by the FDA nor the EU. There is not a recognized official category for these robotic devices. Future versions of personal care robot standard should include more details to define the

³⁵⁵ Robotics 2020 Multi-Annual Roadmap. For Robotics in Europe. Call 2 ICT 24 Horizon 2020, SPARC, 2015, p. 287

³⁵⁶ See <http://www.ifr.org/service-robots/>

³⁵⁷ Dinwiddie, K. (2015). Basic Robotics. Nelson Education p. 117

³⁵⁸ We have already argued that for us these robotic device should have followed the person carrier or the physical assistant restraint-free type requirements and not the requirements of mobile servant robots. Found in the following website, last entrance 12 August 2014: news.panasonic.net/archives/2014/0319_26411.html.

³⁵⁹ See the classification discussion at Marszalek, J. (2013) Classification Discussion: Mechanical Wheelchairs. FDA. Available at www.fda.gov/downloads/AdvisoryCommittees/CommitteesMeetingMaterials/MedicalDevices/MedicalDevicesAdvisoryCommittee/OrthopaedicandRehabilitationDevicesPanel/UCM378318.pdf

robots within the scope of that ISO, for instance by adding a sentence like: “excluding wheelchairs recognized as medical devices” (similar to the added sentence in the general definition of personal care robot, “excluding medical applications”). This problem of definition and differentiation, however, could be solved once the proposal for a regulation of medical devices (chapter 1) comes into force. Then, and by extension, any relevant hazard from a medical device that is considered also machinery (in this case “wheeled passenger carrier”) should have to comply with the requirements of the machinery directive. The question here is: does the machinery directive (not the machinery standard, nor the personal care standard) include them as machinery?

Person carriers should neither be confused with self-driving cars, as the standard expressly excludes robots faster than 20km/h. The state-of-the-art, however, will reveal that rigidity in the application of these criteria will lead us to under-regulated scenarios: there are person carriers that can go faster than 20km/h³⁶⁰. They cannot be confused with robot toys, even if we have seen robot toys used as person carriers and in rehabilitation settings (but not considered wheelchairs because there are no wheelchairs for 0-3-year-old children)³⁶¹. And, finally, special attention should be drawn to mixing categories, e.g. person carriers that transform into mobile servant robots³⁶².

Although we tried to avoid any possible confusion with wheelchairs, no bibliography concerning “wheeled passenger carriers” can be found. Also the little information available is another major reason that pushed us to address this category.

2. Context

A framework for the evaluation of the impact of personal robots demands special consideration of the context of use: a hospital, a private dwelling or a public space³⁶³. The type of user that will benefit from a personal robot will also matter from a legal perspective – especially if this technology is used by elderly, infirmly people or children.

The Chairman of the ISO TC 184/ SC 2/WG 7 on Safety of Personal Care Robots, Prof. Dr. Gurvinder Virk, argued that within “wheeled passenger carriers” we should be thinking about “cybercars” similar to the ones in Schiphol airport³⁶⁴. The official personal care standard, however, only mentions the multiple passenger option in one tiny passage of the standard and does not include any further reference in the examples given in its Annex D. The following CRIA will be conducted, therefore, on the type 3.1. in section 6.1.2.3. of ISO 13482:2014, i.e. person carrier where a single passenger will be standing, used in indoor flat surfaces, lightweight, slow and statically stable. A specific CRIA for another type of robot should be conducted to accommodate all the different specificities.

Recent hospitals and nursing homes have incorporated autonomous grounded vehicles (AGV) in their facilities to ease some of the care delivery processes. This idea

³⁶⁰ For instance, the segway “patroller” can travel at the speed of 24 km/h. If the speed is a *condition sine qua non* for the application of this standard, it should be important to oblige the producers of this kind of technology to not surpass the speed limit (which could be done solely through legal enforcement) www.segway.com/products/public-safety/se-3-patroller. See also DTV Shredder at bpgwerks.com

³⁶¹ For the American project see Galloway, J.C., et al. (2008). Op. cit. For the confusing categories presented in ISO 13482:2014, see Fosch-Villaronga, E. (2016). Op. cit.

³⁶² See robot.segway.com

³⁶³ Van Winsbergue A. (2013) Designing Robots for Care: Care-Centered Value-Sensitive Design. *Sci Eng Ethics* 19, pp. 407-433

³⁶⁴ See <https://clawar.org/wp-content/uploads/2015/04/ISOStandardization.pdf>

comes from the nineties³⁶⁵. The Hospital Universitario Central de Asturias in Spain (and the Hospital de Reus, Catalonia) has incorporated them in order to streamline some of the basic tasks of the nurses, i.e. deliver food, medicines and clothes to the patients' rooms (*see* Fig. 2). At the beginning it was not clear if these robots were part of the personal care standard because within the category of person carrier it is foreseen the transportation of other objects like pets or property. An interview with Prof. Dr. Gurvinder Virk, clarified that those robots were improving the quality of the process of the institution, and not directly the quality of life of the patients. Therefore, they should be considered industrial robots. In fact, AGV in other settings are considered industrial robots. Nevertheless, some doubts about considering these robots as personal care robots still remain (*see* below).



Figure 22 Autonomous Grounded Vehicles in the Hospital Central de Asturias. Own photography.

The AGV, also called “manolitos” in Asturias, Spain, speed up the delivery of food from the main kitchen to the different bedrooms, the delivery of medicines from the pharmacy, and the delivery of clothes from the laundry; but their main goal is not to improve the quality of life of the persons. Although these robots seem to be service robots because, contrary to the typical industrial robots, they share the space with humans, they are not improving the quality of life of their users. Furthermore, they are still in very structured environments, there is the need of trained personnel to use them, and, the HRI is minimum: the robots have their own elevators, their own corridors and there is practically no human contact (*see* Fig. 3). Although they are not caged, they are nevertheless kept away from the contact with humans.

³⁶⁵ Barghava, S. and Didia, D. (1992) Automated Guided Vehicle Time-Out Analysis. University of Michigan Hospital. Available at: http://umich.edu/~ioe481/ioe481_past_reports/w9208.pdf



Figure 23 Exclusive Robot Corridor (1) and Robot Elevator (2) where you can read in Spanish “Robots exclusive use”. Own photography.

These reasons seemed not enough to convince us of their industrial robot consideration. In 2016, our doubts on the appropriate classification of the functionality of these robots found a reason to exist: Panasonic was awarded the personal care robot certification for a HOSPI(R), a delivery robot that delivers autonomously pharmaceuticals and specimens on behalf of hospital staff³⁶⁶ (see Fig. 4).

HOSPI(R) was awarded several Japanese certifications and the personal care robot one from ISO. It was assessed as a “mobile servant robot without manipulator” a category found only on the Japanese standard JIS B 8446 (inspired by ISO 13482:2014). The functionalities seem to be basically the same as the AGV with the only difference that HOSPI(R) does not need sensors or electromagnetic tapes on corridors (which the AGV have). For the rest, they practically work on the same level. Furthermore, although these robots allow nurses to do more important work³⁶⁷, some interviews with the workers (in Spain) revealed that in reality this system was taking their jobs away.

Besides the confusion regarding the categorization of these robots, there are robots operating in hospitals and nursing homes that are not considered medical devices; their scope and intended use is simply another one. If food, drugs and clothes are transported

³⁶⁶ See more information at news.panasonic.com/global/topics/2016/45099.html

³⁶⁷ See newatlas.com/panasonic-hospi-r-delivery-robot/29565/



Figure 24 Already mentioned Hospi(R) from Panasonic. Source: news.panasonic.com/global/topics/2016/45099.html

around the facilities of a medical care institution, it is likely that such institutions can be interested in incorporating some autonomous wheeled passenger carriers in order to transport the patients within the facilities, which is a very time and effort-consuming task³⁶⁸. Indeed, nurses need to spend time going to the rooms of the patients, put them into the wheelchairs and then push them until the dining room, which sometimes includes having to take the elevator - sometimes the elevator is so small that the nurse needs to push the button, and then go downstairs through the staircase. As the process takes time, the patients wait outside the dining room waiting to go in. Again, the caregivers will have to push them into their assigned sit in the dining room. Depending on the size of the nursing home, a staff of many people is often required³⁶⁹. Although sometimes elderly can move, walk a bit and sit by themselves in a wheelchair, their transportation to

other places takes a lot of time. In addition, these actions should take place for each meal (usually three) during the day, at scheduled times, which further complicates the task for the nurses.

Based on these lines, the context for person carriers will be the following one:

«The nursing home Queen Charlotte has just incorporated 50 i-Resyone³⁷⁰. These person carriers will improve current residents' mobility around the different pavilions the nursing home has. The person carriers will convey persons within fixed intended destinations, e.g. from the bedroom to the dining room or to the activity room. Residents are also free to use them for personal purposes such as going outdoors with them. These robots will save time to nurses that now can focus more on other important things. Queen Charlotte's person carriers are programmed to pick patients up at 7am, 12pm and 6pm at their bedrooms for breakfast, lunch

³⁶⁸ This information has been collected from oral interviews we have had in the hospitals as well as in a nursing home in Banyoles, Catalonia. Furthermore, it is corroborated by the success of RIVA, the robot we mentioned in chapter 1 that transports patients from the bed to the wheelchair.

³⁶⁹ In Japan for instance there is an increasing demand of caregivers. And that is why the employment of robotic technology seems to be developing faster; not only because of cultural aspects but also for the need of the society. Vid. www.roboethics.org/atelier2006/docs/Kitano_slides.pdf; the robotic strategy in www.meti.go.jp/english/press/2015/pdf/0123_01b.pdf and the robotic Nurses project at Stanford university: cs.stanford.edu/people/eroberts/cs201/projects/2010-11/ComputersMakingDecisions/robotic-nurses/index.html. This is very similar to what is happening in Austria, see Payr, S., et al. (2015). Potential of Robotics for Ambient Assisted Living. Vienna: FFG benefit; but also in all the south European countries that are suffering the cuts from the crisis of 2008.

³⁷⁰ For more information see the section "type of robot". In any case, i-Resyone is a combination between the i-Real prototype from 2007 from Toyota and the robotic bed from Panasonic called "Resyone". In any case, see both www.toyota-global.com/showroom/toyota_design/award/i_real/ and news.panasonic.com/global/topics/2014/26411.html. This case has also been inspired by the example given by ISO 13482:2014 on its Annex B, p. 66, when it mentions the case of a mobile autonomous person carrier that works in a museum. These three robots were used to create i-Resyone which combines very important features of all three: transformation into a bed, inserted inside a building, and capacity to go outdoors as a wheeled passenger carrier.

and dinnertime. Depending on each patient, they are also programmed to convey them back for a siesta or for activities. Doctor and hairdresser's appointments are included automatically in the robots' schedules. Patient's free time is from 9am-11:30am and from 2pm-5:30pm.»

World Health Organization (WHO) identifies 16 groups of stakeholders in a nursing environment³⁷¹. In order to conduct the CRIA, however, not all the stakeholders will be involved. The institution needs to consider: its own structure, the main objectives, roles, decision-making processes, division of responsibilities, and right timing for conducting the assessment. A team in the institution will develop the CRIA. Depending on the robot characteristics, the quantity of carriers, and the personnel in the residence, a group of technicians may be required to permanently monitor the proper functioning of the equipment, as it happens with AGV in hospitals. Technicians are of crucial importance when this kind of devices are included, especially to remediate errors, faults or system breaks in time in order to avoid fatal undesirable outcomes. Nurse practitioners will normally be part of the team, as they are in charge of look after the patients and know the patients' needs and worries. They can help to identify which features are needed for a robot to be effective, for instance to incorporate a belt in case of protective stop because they know –according tot their experience - that some of the patients slip when it happens. The directors of the institution will normally monitor their employees and will decide on what measures can be taken to mitigate any risk posed by the robots.

The protection of the user is what matters the most. In a normal nursing home, there are patients with large variety of profiles. Some patients are just old and do not have any particular disease, but they live there for several reasons – their children do not have time to be with them or they do not have family. Some other patients have certain kinds of diseases, either physical or cognitive, and their family cannot take care of them. The use of person carriers can help provide a more personalized care, and can support patients to regain a bit more of independence.

Regarding the context, the building plays a major role. The nursing home in Queen Charlotte has one main four-story building, and one-floor logistics building. There are 270 beds of which 20 are unoccupied, 40 are for people that cannot move out of the bed, and the rest 210 are for patients that can with more or less help, use a person carrier. Some of these 210 patients suffer from cognitive disabilities; some of them are overweight. There are large corridors and big elevators that were already used for wheelchair patients. There are 6 elevators. Charging points have been installed in each floor. Twenty-five devices have been supplied in the nursing home which perform around which perform around 150 transports a day. They travel around 40 km/day. They can support up to 150 kg (*see* a summary in Table 14).

³⁷¹ Health Service Planning and Policy-Making. A Toolkit for Nurses. Module 2: Stakeholder Analysis and Networks. World Health Organization, Western Pacific Region.

Nursing home	270 Beds(Users)	Performance	Supply
1 main building, 4 floors	20 unoccupied	150 transports/day	6 elevators
1 logistics building, 1 floor	40 fully impaired users	40 km/day	25 PCaR
1 bulding for rehabilitation	25 overweight users	Max. 150 Kg	4 charging zones
1 building for activities	185 abled users		
1 building for personal care: hairdresser, pedicure.			
6 elevators			
4 charging zones			
WLAN Infrastructure			

Table 4 Nursing Home Queen Charlotte Context

Nursing homes are structured environments, with rules and timetables for meals, bathing, doctors, and visits. Although their correct functioning relies on several aspects (e.g. size, staffing hours, ownership or resident characteristics)³⁷², they are more organized than personal homes. Structured environments can provide useful knowledge to the wheeled passenger carrier setting and control planning. This in fact diminishes directly the likelihood of encountering difficulties or barriers such as glass walls (difficult to avoid by current lasers). Indeed, nursing homes are typically designed with big corridors, ramps and big elevators. If this information could be incorporated to the carriers, it would be extremely valuable.

One of the problems of the carriers of Queen Charlotte residence is that they can actually go outdoors, that is, they can move out from the structured environment that the nursing home offers. The control planning in this case is a bit more difficult due to the inaccuracy of current GPS systems, which do not include the localization of trees, garbage bins or other recognized obstacles. The Automated Transport and Retrieval System (ATRS) could be of help, for mobile robotics outdoors that can operate in the vicinity of the nursing home and in collaboration with people³⁷³, it only depends on whether the nursing home wants to incorporate other parts of the city that are not adjacent to the nursing home³⁷⁴.

3. Robot type: Wheeled Passenger Carrier

Due to its novelty, not only specific regulations dealing with person carrier robots are still missing, but also literature referring to “wheeled passenger carriers” is practically non-existent. The majority of the relevant scientific publications in the major bibliographical engines refer to robotic wheelchairs - which currently are not all considered medical device (only stair-climbing function).

Relevant literature on robotic wheelchairs and person carriers with navigation capabilities uses obstacle avoidance or environment sensing will be used to describe the type of robot. As we have said, the scenario that is going to be analyzed is fictional but is inspired by different already existing robots: i-Real from Toyota (2007), Resyone

³⁷² See Harrington C. et al (2000) Nursing Home Staffing and Its Relationship to Deficiencies. *Journal of Gerontology* 55B, 5, pp. 278-287

³⁷³ See Gao, C., et al. (2008). Autonomous docking of a smart wheelchair for the automated transport and retrieval system (ATRS). *Journal of Field Robotics*, 25(4), 203.

³⁷⁴ Although referring to wheelchairs, Gao, C. et al. tried to improve the system they created in their previous work in 2008 enlarging the capacities of ATRS in wider places. At this regard, see: Gao C et al (2010) Towards Autonomous Wheelchair System in Urban Environments. In: Howard A et al (2010) *Field and Service Robotics* 7, STAR 62, pp. 13-23.

from Panasonic (2014) and AGV ³⁷⁵ . We have called it: the i-Resyone.

3.1. Description of the Robotic System and Applications

Current wheeled passenger carriers, beyond the sensors and their capacity to transport a person from one location to another, have other interesting capabilities. I-Resyone can be transformed into a bed, and two handles at the back of the robot can be used for the user as a powered walking aid³⁷⁶.



Figure 25 Envisioning i-Resyone. Sketch Vite-fait from Helena Heras

I-Resyones are designed to be in nursing homes. Their design is compact and they are easy to maneuver. They are designed on a return-on-investment basis and can be integrated into existing buildings without significant construction. They pay back both in terms of time and efficiency but also in terms of quality of care delivery: while the person carrier autonomously transports the patients to the different pavilions or to the dining room, nurses can focus on other activities and the patients have more time to spend in other activities³⁷⁷.

I-Resyones can have different applications. Their main application is to convey the patients from their rooms to the dining room during breakfast, lunch and dinnertime.

³⁷⁵ See www.ds-automotion.com/hospital_healthcare/ueberblick.html

³⁷⁶ Lee, H.J. and Jung, S. (2010) Guidance Control of a Wheeled Mobile Robot with Human Interaction Based on Force Control, *International Journal of Control, Automation, and Systems* 8(2) pp. 361-368.

³⁷⁷ As we explained before, this is the fundamental problem that nursing homes have: as they lack of personnel, the staff needs to go room by room, pushing the manual wheelchairs until the dining room, and then the patients need to wait until they can go into the dining room (sometimes waiting in line or next to the other one on the hall in front of the dining room). If this system could be implemented, the patients could spend more time in their rooms or elsewhere, because then the process of conveying to the dining room would be faster as it is currently.

They can be used also to convey the patients to the places where they have different activities, such as music hour Tuesday morning, newspaper reading on Wednesday; or private activities such as hairdresser, pedicure or doctor's appointment. The person carriers can be programmed to pick the patients at appropriate times. Over time, carriers can learn the schedule of the patients (that tend to be a daily routine with no variation except for extraordinary facts such as hospitalization or holidays with the relatives)³⁷⁸. All the activities in the center therefore can be coordinated through these devices: doctor appointments, hairdresser, meals, activities, showering times, family visits... As i-Resyones are reliable, flexible, safe and adaptable to new environments, patients can also use the carriers in outdoor contexts. At the same time, the devices can be in "follow-me" mode, i.e. up to 12 wheelchairs can follow a leading wheelchair without the use of joystick or any other interface, which helps caregivers to take more than 1 patient for a walk at the same time³⁷⁹; or they can be teleoperated through an app.

In general, it is estimated that the use of i-Resyones can save up to 3.000 hours a year that can be used to spend more time with the patients doing therapy, listening to them or for them to spend more time with their families³⁸⁰.

i-Resyones can work in autonomous but also in shared autonomous mode. The carriers will be fully autonomous when conveying the patients inside the nursing home for fixed activities, such as going to the dining room or going to the activities. If the user wants to use them for personal reasons and to go outside of the nursing home, the autonomy will be shared between the user and the robot. The system is done to respect the volitional control of the user. In any case, some places outside the nursing home are already included into the system to ease the travel burden and reduce some of the risks linked to the autonomy. Security of its navigation is improved by intertwining the user, the robot and the environment.

HRI with this kind of robot is physical and passive, because the person is simply seated on the robot (or stood up on a foothold) but does not interact physically in another manner with the robot. Depending on the user interface, this interaction can be a bit different. Of course, the more sophisticated the carrier, the higher the risks associated with it. Based on the passive physical interaction, the modules that will be normally involved in carriers are safety, autonomy and liability because they do not normally perform legal transactions or communicate with the user on an emotional level.

3.2. Characteristics of the robotic system

The i-Resyones do not work independently. On the contrary, they are integrated into a "robotic system" that includes:

- Wheeled passenger carriers
- Architecture: Communication system (Ethernet and wireless) and cloud system

³⁷⁸ As stated in their website, this MIT project is developing an intelligent wheelchair that spans multiple domains, including robotics, artificial intelligence, machine learning, human computer interaction and user interface design and speech recognition systems. For more information *see* rdsn.csail.mit.edu/wheelchair/.

³⁷⁹ This characteristic has been inspired by the Follow Me Project conducted in 2014 between the University UPC and La Salle – Ramón Llull University from Barcelona and the Instituto Robótica in Sitges, Spain. The main researchers, C. Angulo and J. Albo-Canals developed robotic wheelchairs capable to follow a main wheelchair. *See* <https://institutorobotica.org/en/projects/follow-me/>.

³⁸⁰ *Ibidem*.

- Elevators and Charging battery points
- Interfaces
- Ambient intelligence
- Software: functions and interface
- Cloud system

A) This precise wheeled passenger carrier – i-Resyone, includes the following characteristics:

- It has one single seat. To allow boarding, it lowers itself to ground level.
- The base of i-Resyone expands and contracts depending on the mode it is working on – walking, cruising or bed mode:
 - o The walking mode is used for pedestrian areas. The base in this mode is contracted, in an upright position. User/driver’s eyes are aligned with pedestrians or other users (in indoor cases) to give a sensation of natural movement. Maximum speed in this mode is 6km/h. In this position, the length of the carrier is 1000mm, width is 720mm and height is 1400mm.
 - o In the cruising mode, the base is expanded until it gets the dimensions of 720mm wide, length to 1510mm, height 1000mm. The seat is reclined and maximum speed is 30 km/h. As the center of gravity is lowered, sense of stability and higher-speed travel is enabled. The front wheels lean independently for greater stability when cornering.
 - o In bed mode, the base is expanded to the maximum until it gets full horizontal position and it can be incorporated into a bed.
- Wheels are suspended by a leading arm arrangement to absorb small surface irregularities
- In shared control, i-Resyone is controlled through two joysticks – one for each hand.
- Pulling back on the controls or using the index finger trigger, brings i-Resyone to a protective stop. There are, in any case, two buttons for emergency stop.
- The braking system is achieved both by the electric motors – which then work re-generatively to charge the batteries – and by traditional friction braking.
- 4 lights and 1 horn are used as optical and audible warning – to make aware those surrounding the user.
- Perimeter monitoring sensors sense pedestrians or objects and try to prevent a collision by vibrating to warn the driver. The perimeter is divided in two zones: 1) warning zone, in which the device will reduce speed, and 2) a protection zone, in which protective stop is activated.
- Other sensors include: inclination sensors and inertia sensors (to help in torque)³⁸¹, webcams (to localize obstacles)³⁸², laser-range finder and encoders (to localize the device), and ultrasonic array (for emergency collision avoidance). Front and rear lasers can detect obstacles too, enhance

³⁸¹ Matsui T et al (2015) Development of a Power-Assisted [5] Wheelchair with Consideration of Driving Environment – Dynamic Estimation of Slope Angle and Adaptive Control System Design. International Journal of Materials Science and Engineering 3:1, pp. 25-30

³⁸² Muñoz, J et al (2006) A Description of the SENA Robotic Wheelchair. IEEE MELECON, pp. 437-440

environment map construction and help with the robot localization in urban environment³⁸³. They also incorporate an on-board navigation system that stores navigation maps for future utilizations. As they use virtual path and lasers, they do not require embedded wires or magnets or other building modifications.

- i-Resyone has a seatbelt.
- The rear screen is programmable to reflect the driver's personality, as this is a small side screen - also used for communication, navigation and entertainment. The carrier can also include communication devices, voice recognition and also tablets and smartphones. Each of these devices proportionally increases the complexity of the regulatory framework behind them: the more sensors and the more capabilities the carrier will have, the more legal principles will be involved.
- LED lights, located in the wheel arches, provide illumination, clearance lighting and also house indicators which are self-actuated when the device enters a turn.
- Capacity to turn 360 degrees in order to provide maximum maneuverability
- Six electric motors control forward movement (two for each wheel, located within the wheel), vehicle inclination (two), the extension of the rear wheel (one) and direction (one)
- Powered by lithium-ion batteries that are charged via the charging points.
- In order to help the environmental credentials of this already low emissions vehicle, i-Resyone uses kenaf-fibre bioplastic in many of its softer panels. Acrylic resin panels are used where greater strength or impact resistance is required.
- They are protected under the IP54 code of ANSI/IEC 60529-2004 Degrees of Protection Provided by Enclosures (IP Code)³⁸⁴

Of note, person carriers are going to be just a "thing" inside the Internet of Things (IoT). IoT person carriers will increase sociability and ease of use, as IoT in outdoor environments (including traffic and traffic lights communication, smart zebra crossing communication, etc.³⁸⁵) will offer more reliance of the operation³⁸⁶. It is true, however, that IoT person carriers have been geared towards a medical-device direction instead of the outdoor context³⁸⁷. Latest person carriers incorporate health-measuring devices such as blood pressure, body temperature or heart rate monitoring devices. These

³⁸³ Gao C et al (2010) Towards Autonomous Wheelchair System in Urban Environments. In: Howard A et al (2010) Field and Service Robotics 7, STAR 62, pp. 13-23

³⁸⁴ The standard ANSI/IEC 60529-2004 Degrees of Protection Provided by Enclosures (IP Code) describes a system for classifying the degrees of protection provided by the enclosures of electrical equipment. IP rating comprises of a two-digit number, in this case *IP54* where the first two represent the level of dust protected (in here: ingress of dust is not entirely prevented, but it must not enter in sufficient quantity to interfere with the satisfactory operation of the equipment; complete protection against contact) and the other two reflect to the level of protection considering the contact with water (in this case it is protected against water splashing).

³⁸⁵ Anekar, A., Bagade, N., Jogdand, A., & Tayade, M. (2016). Automatic Traffic Signal Management System. Imperial Journal of Interdisciplinary Research, 2(6). For the smart pedestrian crossing *see* www.dailymail.co.uk/sciencetech/article-2579362/London-test-smart-pedestrian-crossings-stay-green-longer-theres-big-crowd.html

³⁸⁶ Coetzee L and Olivrin G (2012) Inclusion Through the Internet of Things. INTECH Open Access Publisher, pp. 51-79

³⁸⁷ At this regard, *see* the project that Dr. Hawking has been carrying out with the company Intel: www.intel.com/content/www/us/en/internet-of-things/videos/dr-hawkings-connected-wheelchair-video.html

capabilities are going to transform the concept of a simple personal care robot under the regulation of ISO 13482:2014, and the incorporation of all these medical device functionalities will have to be analyzed under another corpus (the extension of medical device regulation we were talking before).

It will be challenging then to categorize a personal care robot that has direct access to health information from the patient (to convey the patient to the first-aid service for instance in case of high heart rate beat), when this information is not collected directly but is derived from wearable medical devices.

B) Other parts of the robotic system

Concerning the charging battery points, they are located in different parts of the building. The carrier detects autonomously when batteries need to be charged. The process is completely autonomous and it is done in valley moments, that is to say, in the moments of little activities. It is possible to make express recharges of 15 minutes although the entire recharge takes place normally during night when the patients are sleeping. As there are more carriers than charging points, they need to coordinate themselves

The elevators provide automatic vertical transport for the carriers. Control interface equipment and softwares allow the carriers to call and use the elevator. Depending on the facilities, the person carriers will use elevators reserved just for robots as we mentioned in Fig. 2 (2). In Queen Charlotte Residence, the elevators are shared with humans. The system is done in a way that the robot will allow persons to use the elevator first.

There is also a carrier washing system. As different people use the carriers, they go outdoors, and they get dirty, there is an autonomous system that washes them automatically. The washing booth can wash up to two i-Resyones at the same time. There is a register of the performed cycle.

Concerning the communication and control architecture, there is communication Ethernet through cable between the traffic control system and peripheral, i.e. charging stations, elevators and doors. There is a wireless (WiFi) connection between the AGV and the traffic control system. i-Resyones can be called in taxi mode through user-friendly tactile screens incorporated in each of the rooms which work wirelessly. They can be called also through smartphones or tablets. The arrival notice can be sent through e-mail, sms or phone. The engineering team can visualize in real time the ongoing orders, the pending orders, exact position of the AGV, alarms and also notifications about any preventive maintenance. In fact, the software allows also having 3D graphics, to know the status of the elevators.

In the following sections we will identify risk scenarios based on this type of robots that challenge the current industrial standards, as they merely focus on physical HRI. The principles highlighted and explained in the previous chapter will be used.

4. Risk Scenarios

4.1. Safety

«Anna is new to the nursing home. On the very first week, she takes the person carrier to go outside the nursing home. She presses some buttons and the carrier transforms into a bed. After she fixes it, she goes into a pedestrian zone. The carrier stops every now and then to

avoid collision with objects and pedestrians. Some pedestrians complain about the person carrier on the sidewalk. The system detects a failure and stops in front of a garage. Anna cannot move it and has no phone to call the residence. A car wants to go out from the garage. There are some roadworks on the street and there are some sewers without cover. Unfortunately she goes in one and falls down. »

As these robots are meant to transport users from A to B, person carrier safety safeguards are based on collision avoidance, tipping over prevention and safe maneuvering (*see* following sections). Their sources of danger are:

- extrinsic to the device: unstructured environments (either outdoor or indoor contexts), weather conditions, internet of things environment;
- inherent to the device: non-mission tasks, mode transitions, sensors that detect the intention of movement, internal parts of the robot (charging battery, energy storage), external parts (robot shape and motion), etc.;
- concerning the user: user's perception and lack of experience, feeling of pain or discomfort.
- concerning its transformations: if the carrier transforms into a bed, or if it transforms into a mobile servant robot;
- in general all the risks identified by ISO 13482:2014

ISO 13482:2014 establishes a detailed hazard breakdown either for 1) the internal parts of the robot: charging battery, energy storage and supply, robot start-up electrostatic potential, electromagnetic interference; 2) its external parts: robot shape, robot motion; 3) but also includes human-related hazards such as stress, posture and usage, contact with moving components, lack of awareness of robots by humans, etc. The standard adds hazardous environmental conditions and also hazards due to localization and navigation errors. These are generally attributed to all personal care robots even though some specificity is given for person carriers. Along this section we will identify these hazards for person carrier robots, with a particular focus on wheeled passenger carriers.

Similar to what happens in wearable technology, the “actual customers’ perceptions of the benefits are more influential than their concerns about the risks”³⁸⁸. This is caused by a disinformation on the actual risks: first, the providers are more interested in focusing on the benefits rather than on the risks; second, researchers tend to investigate the benefits of a certain technique or device rather than the bad consequences of its use; and third, costumers tend to compare the new device with other more familiar devices, although they might differ largely in terms of hardware architecture or function.

Common risks for robotic wheelchairs in the safety scenario were identified in the EPIOC project³⁸⁹. These included tipping over; collision with people, furniture, and even cars; and difficulties in maneuvering in certain environments. Wheeled passenger carriers have similar risks.

To avoid tipping over and reduce the risk of death, ISO 13482:2014 insists on stability control. For person carriers, it establishes that when the autonomous mode is

³⁸⁸ Heetae Y. et al. (2016) User Acceptance on Wearable Devices: An Extended Perspective of Perceived Value. *Telematics and Informatics* 33, pp. 256-269.

³⁸⁹ Souza L et al. (2007) Young People's Experiences Using Electric Power Indoor-Outdoor Wheelchairs (EPIOCs): Potential for Enhancing User's Development? *Disability and Rehab* 29:16, pp. 1281-1294.

on, the robot's performance should have some limits in terms of workspace and avoid forbidden areas. The importance is to smoothen the tasks in order to avoid tipping over, and to incorporate autonomous communication capabilities if the system detects the wheelchair has tipped over³⁹⁰.

In respect of obstacle avoidance, collision avoidance systems are at the core of any carrier (wheelchair, driverless cars) especially in unstructured environments like the street³⁹¹. Person carriers also incorporate collision avoidance systems. Some efforts have been made to solve collisions including real-time navigation systems similar to the systems other technologies employ, e.g. unmanned aerial vehicles or missiles³⁹². Yet, this is not an extended case for person carriers. In fact, there is much diversity on the used systems as there are no set guidelines.

To avoid collision with people, some of the participants in the EPIOC project suggested adding a horn or a sounding device to make people aware of their presence, as bikes or other means of transportation. In fact, "silent operations can increase the probability of collision with persons", and that is why ISO13482:2014 suggests the inclusion of a sounding device. At the same time, the standard reminds that alternative indications should be required for people with sensory impairment. Concerning other lacks of awareness, e.g. the lack of awareness of the collection of personal data from the user, nothing is said in the standard although the violation of personal data rights can lead to unfortunate scenarios not directly related to physical harm (*see* section user's rights safeguards).

Beyond the fact that from the policy perspective a robot should incorporate the best avoidance collision system, as a general recommendation a person carrier conceived for structured environments should not be used in outdoor contexts without any adaptation. The manual of use could warn of it. The standard tells that localization errors can lead the robot to enter forbidden places or to lose mechanically stability in hazardous manner (e.g. falling downstairs) and this should be prevented. If the person falls down into a manhole in the street because the system was not prepared to detect such a sporadic hole in the outdoor context, the roboticist might not be held liable if he already set down the rules for indoor contexts. On the contrary, if the wheelchair can go outside the premises of the institution and it is not capable of detecting such a hole, then the collision avoidance system should be revised (as not only is important to avoid collision but also any architectonic barriers there might be in the pathway of the robot).

To cope with the tipping over and the collision avoidance, the control strategy will play a major role. We are referring to the autonomous and shared autonomous mode of control of the carrier. Wang and Gao aimed at creating autonomous person carriers, however, they found out that shared control was preferable³⁹³. Autonomously controlled carriers can improve deficiencies of shared control, yet autonomy is still characterized by faults. Furthermore, the users in that study had the impression that their decision-making process was taking over in autonomous mode and felt more secure when driving themselves the wheelchair.

ISO 13482:2014 mentions that the navigation capability of a personal care robot should be sufficient to realize a movement to any reachable goal. The main problem,

³⁹⁰ This last requirement is not in ISO 13482:2014.

³⁹¹ Talebifard P et al (2014) A Risk Assessment Infrastructure for Powered Wheelchair Motion Commands without Full Sensor Coverage. IROS, pp. 3592-3597.

³⁹² Wang C et al (2013) A Collision Avoidance Strategy for Safe Autonomous Navigation for an Intelligent Electric-Powered Wheelchair in Dynamic Uncertain Environments with Moving Obstacles. European Control Conference, pp. 4382-4387.

³⁹³ Faria B M et al. (2014) Adapted Control Methods for Cerebral Palsy Users of an Intelligent Wheelchair. Journal of Intelligent Robot Systems 77:299-312.

however, is that complete sensor coverage to detect nearby objects remains a challenge due to financial, computational, aesthetic, user identity and sensor reliability reasons³⁹⁴. Current sensors may sometimes not work properly, which could, in fact, have a direct impact on liability and insurance issues.

In order to detect user's motion intention, the user will use the interface of the device. The interface should be intuitive, easy to use, and avoid misunderstandings³⁹⁵. This is very important, as the industrial standard highlights it as a hazard³⁹⁶. i-Resyones are not controlled through brain-computer interfaces, but if that was the case, and as sensors need to be weighted between the richness of information they provide and the level of their invasiveness³⁹⁷, the use of electromyography would be recommended³⁹⁸.

Environmental sensing could help reduce the volume of sensors incorporated into the device. The use of a cloud platform could help manage all the sensor information and lighten the weight of the robot. ISO 13482:2014 recommends that robots should be able to adjust to the path planning or to stop and provide a warning. In any case, sensors should be used for the purpose they were created for: if cameras are added to detect obstacles, they should be used for that purpose and not to identify users or third parties. In this regard, some blur mechanisms for avoiding third parties faces recognition could be included. A massive collection of data for other purposes competing with personal identifiable information should be limited as it could in aim to balance the amount of data needed to perform the task and the principles of data minimization and data minimum storage (although it might not be very feasible sometimes).

Other risks have to do with the capabilities of the robot. If the person carrier could climb stairs, for instance, smoothness in the climbing process would become indispensable. This could help avoid feelings of fear from the user or more importantly, tipping over. Although i-Resyone has not this capability, some projects are working towards a low-cost perfection of this function³⁹⁹, which could facilitate the access to the technology and therefore comply with the principle of justice⁴⁰⁰.

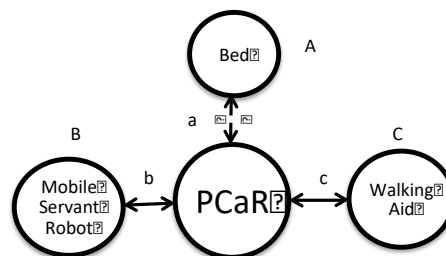

³⁹⁴ Shiomi M et al (2015) Effectiveness of Social Behaviors for Autonomous Wheelchair Robot to Support Elderly People in Japan. PLoS ONE 10(5), pp. 1-15.

³⁹⁵ Robotics 2020 Multi-Annual Roadmap. For Robotics in Europe. Call 2 ICT 24 Horizon 2020, SPARC, 2015

³⁹⁶ ISO 13482:2014 mentions it as “poor user interface design and/or location of indicators and visual displays units”.

³⁹⁷ Tucker M R et al (2015) op. cit.

³⁹⁸ Pal, K. (2016). Development of a Surface EMG-Based Control System for Controlling Assistive Devices.

³⁹⁹ More information at scalevo.ch.

⁴⁰⁰ It is important to know that there are companies or research centers working solely on different functions so that these can be implemented afterwards in different devices. For instance, at Carnegie Mellon University, Laura Herlant is working on the “feeding function” of an assistive dexterous robotic arm robotic that is incorporated into a robotic wheelchair. She is under the supervision of Henny Admoni and working with prof. Siddhartha Srinivasa at the Personal Robotics Lab.

Figure 26 States and Transitions of i-Resyone

Person carriers can be transformed in several other devices such as a bed, a walking aid, or even a mobile servant robot⁴⁰¹. Resyone was the first robotic device to obtain ISO 13482:2014 certification. It is a robotic bed that transforms into a wheelchair. Although “wheelchair” refers to the medical device category, and although “wheeled passenger carrier” is a sub-type of the person carrier robot category, Resyone was assessed by the mobile servant category. Similarly to Resyone, if the person carrier can be transformed into different robots, a risk assessment concerning both the states and the transitions will have to be conducted. Here states are identified in uppercase (A, B, C, and zero state that would be the person carrier, here as PCaR) and transitions in lowercase (a, b, c, and the transitions back to the same position).

Regarding the protection of the user within the modes and the transitions between modes in multi-functional person carriers, heuristic rule-based classifiers could be a simple but effective method to apply. These rules could prevent the device from inappropriately switching back and forth between modes if the user does not allow it. For instance, and if the carrier had a stair-climbing function, it could be pre-established that stair-climbing function is not operative once state A (bed) is on. State A could be also prevented if the carrier is outside of the nursing home premises (to avoid what happened to Anna in the case scenario). In any case, mode transitions should be done smoothly and in a way that protection to the user is granted in both the state and the transition between states.

The standard also addresses protective stops. System failure leads the device to a protective stop mode. Although the stop is “protective”, some scenarios can imply a big dissatisfaction and a feeling of frustration for the user. For instance, Prof. Srinivasa from Carnegie Mellon University explained the situation of a person that uses a robotic carrier and that, for no-matter what failure, the carrier comes to a protective stop. That situation could create a great difficulty to the users, as they could not reach their destination nor move the device (because the protective stop would not allow it). Creators of person carriers should take this into account in order to prevent the user from having this problem, especially if this can imply third parties (the user from the garage that wants drive his car out the garage). Incorporating communication capabilities with the Institution could be an adequate solution from the institution perspective, but that would not solve the damage or problem caused to the third party (nor would solve the problem if that happens in a time that the institution is not available).

Another comment refers to the protective stop for the collection of data from the user or from the environment. Nothing is said throughout the standard about the inconvenience that the always-on device/collection of data could cause to the user. Some of them might not even be aware of the collection of data, when in reality behavioral analysis could be extracted from the rides of the users (*see* user’s rights).

Intangible and intrinsic factors to the user, such as the user’s safety perception or the user control can also constrain carrier performance in shared autonomous mode. Current ISO 13482:2014 does not contemplate different categories of people regardless of the fact that elderly, handicapped or children can use them. In fact, the disability of the user may blur some boundaries well defined by non-mentally impaired users, and this is something producers should take into account independently of the availability of standards in this regard. This is particularly true when ISO recognizes that several

⁴⁰¹ *See* robot.segway.com

target groups should receive different specifications⁴⁰². Paying attention to the design of the user-interface, as ISO 13482:2014 suggests, could strengthen the reliability of the user to the device and reduce the fear to use it (but for that different safeguards for different types of users should be mise-en-place). Shared control percentages could also be reviewed in the case of vulnerable parts of society, e.g. leaving less room for human decision when elderly drive them (*see* autonomy section). Lack of user experience can significantly impact self-confidence and thus the correct performance of the device. Indeed, the user of the carrier needs to feel secure during all stages of use.

If users are afraid of the device, their control over it may not be adequate. There should be mechanisms to compensate this state of mind, such as safety-related speed control if the device acknowledges strange directions. Some researchers at Dalhousie University in Canada wonder about the possibility to institute a driving test without which PCaR (in that case wheelchairs) could not be operated⁴⁰³. This driving test could be preceded by a period of training where all the safety measures and all the issues could be explained not only to the user but also to the relatives. This is similar to what the Unmanned Vehicle University has established: a drone pilot training certificate⁴⁰⁴.

Environmental sensing could add an additional layer of safety during the navigation process; however, it will be challenging to take into account a lot of things, for instance that leaves on the floor are not objects to be avoided⁴⁰⁵.

Another source of risks intrinsic to the user is the feeling of pain and discomfort. In early stages of a project this sometimes cannot be detected, but addressing it is of vital importance. As ISO points out, ergonomics and stress are a hazard that should be addressed.

As person carriers are conceived to convey persons to an intended destination, and this destination might not only be the dining room or a common area in the nursing home, weather conditions may affect the performance of the device in safety and security matters. Correct feedback to physicians and physiotherapists about such feelings might be controversial in some cases but they are crucial for the risk assessment. That is why future person carriers might be obliged to incorporate stability measures such as the gyroscope stabilization for two-wheeled vehicles in the patent WO2013130656 A1⁴⁰⁶. In any case, weather-proof person carriers could improve the life quality of the users who would be able to use the device on many more occasions.

4.2. Consumer Robotics

«Another day Anna takes the carrier but it breaks. She wants to get it repaired. Technicians found out that its safety features matched the robotic butlers they have at the nursing home but that it does not incorporate the person carrier safety requirements. The nursing home calls the manufacturer to complain. The company says that they had

⁴⁰² The standard says that future editions of this standard will incorporate specific requirements for different types of users. *See* page vi ISO 13482:2014 op. cit.

⁴⁰³ *See*: www.wheelchairskillsprogram.ca/eng/index.php

⁴⁰⁴ *See*: www.uxvuniversity.com/uav-pilot-training-certificate/

⁴⁰⁵ *See* www.iaarc.org/publications/fulltext/isarc2006-00081_200606071430.pdf

⁴⁰⁶ Patent WO2013130656 A1 Gyroscope Stabilization for Two-wheeled Vehicles (2013) from Lit Motor Corporation. Interesting here to mention that on the fools' day of 2016 there was released a video from Google where they introduced the self-driving bike (http://mashable.com/2016/04/01/google-self-driving-bicycles/#YXas_lxUDsqM). Although it was not a real project, this might become feasible in the near future. What is more interesting in this video is the capacity of the bike to never fall. Although it might not be real, if there exists a dynamic stabilization system like this, it could be interesting to apply it for person carriers.

followed some sort of software from the Consumer Product Safety Commission (CPSC) and that the complaint should be addressed to CPSC not to them. Anna is afraid of using the carrier again because she feels she might have a serious accident in the end»

As mentioned in the previous chapter, one needs to differentiate between the certified and the perceived safety. As for the certified safety, a correct attribution of robot categories (not only for person carriers but also for personal care robots in general) is fundamental to protect the user, indispensable for an appropriate risk assessment and essential for legal compliance⁴⁰⁷. If the category is not appropriately chosen, we might apply safeguards and protective measures that do not match the actual capabilities of the robot and the user might be at risk (which might be a serious scenario if we are talking about elderly, disabled people, etc.). Resyone is a good example to explain this concept.

Resyone – a Panasonic product – is a robotic bed that transforms into a wheelchair in order to help users easily transfer from bed to wheelchair⁴⁰⁸. First, the word “wheelchair” is spread all over the description of this robotic device. As we already argued, “wheelchairs”, by default, are not covered by ISO 13482:2014. The use of the word “wheeled passenger carrier” was carefully chosen in order not to mix it with the so-called “wheelchairs” and their connotation of medical devices. Beyond this general description, it is important to know that Resyone was awarded ISO 13482:2014 according to the criteria of mobile servant robots. The macro-category of “wheeled passenger carriers” (if we can accept that Resyone is a “wheelchair” and is part of this category), nevertheless, is not mobile servant robot but person carrier. Mobile servant robots are meant to travel to perform serving tasks in interaction with humans, such as handling objects or exchanging information, like the Care-o-bot⁴⁰⁹. When Resyone’s state is a wheelchair, however, it should be assessed according to the person carrier criteria because its main purpose is to convey the person from one place to another. Because Resyone allows the user to easily transfer from bed to wheelchair, and this is a typical characteristic of the restraint-free physical assistant robot category, Resyone could have also been assessed as a restraint-free physical assistant. Indeed, ISO 13482:2014 defines this type of physical assistant robots as robots that “assist elderly/tired person to and from a chair, bed, etc. To assist in basic mobility tasks on flat ground with or without help from partner. To help provide more ease and comfort in daily life for independent living”. The need for a standard that contemplates the transformation of different devices is evident. At least, the standard should have had taken into account several existing standards in order to assess both states of the robot⁴¹⁰. In the future we might either have a dynamic personalized model which can

⁴⁰⁷ For a more detailed vision, see Villaronga, E. F. (2016). ISO 13482: 2014 and Its Confusing Categories. Building a Bridge Between Law and Robotics. In *New Trends in Medical and Service Robots*, pp. 31-44. Springer International Publishing.

⁴⁰⁸ The exact description can be found at: news.panasonic.com/global/topics/2014/26411.html. “Resyone is a robotic device built on an entirely new concept which fuses an electric care bed with an electric reclining wheelchair. Part of the electric care bed detaches off to serve as the electric reclining wheelchair, thus allowing the user to easily transfer from bed to wheelchair without placing burden on the care giver. With Resyone, only one care giver is require to support safe and simple transfer between bed and wheelchair, thus lightening the load for care givers and making it easier for care receivers to get out of bed whenever they desire.”

⁴⁰⁹ See www.care-o-bot-4.de

⁴¹⁰ This is what happened with the Hospi(R) Robot from Panasonic and the Japanese certifications that we mentioned in chapter 1. Although there is only one ISO 13482:2014, the Japanese standard organization had

include all the safeguards that are relevant for that robot (which could include different aspects of different standards depending on how mixed the robot would be) or we might have to apply multiple standards to the same robot (which could cause an over-regulated scenario).

Unfortunately we could not have access to the documents of ISO and the risk assessment. On the contrary, without having them in hand, we certainly know that if it was assessed by the category of mobile servant robot, then 1) it is not clear what the ISO meant by “mobile servant robots”; and 2) the hazards that the ISO specifies expressly for person carriers were not taken into account: travel instability – rollover due to passenger in incorrect position; rollover during passenger embarkation / disembarkation; or runaway during passenger embarkation / disembarkation⁴¹¹. This is simply because mobile servant robots are not met to embark/disembark users. According to the international standard, the hazards in Annex A are recommendations for the minimum coverage that should be achieved by any given hazard identification exercise. Nevertheless, they will not be met if the standard expressly remarks that they are “applicable only to person carriers”.

This is in line with the fact that robots should not be deceptive. The idea behind the deceptive trade practice is to protect consumer from misleading products⁴¹². This is connected to the idea that person carriers (in concrete “wheeled passenger carriers”) are not wheelchairs. Person carriers should offer no confusion to consumers. As we mentioned: advertising must tell the truth and not mislead consumers⁴¹³. Although the document is specific for advertising on the internet, it is important that if, in this case Resyone, is a “mobile servant robot”, then it cannot be sold as a “wheelchair” (although, as we argued, it should be considered a transforming category between the physical restraint-free type assistant robot and the wheeled passenger robot).

As argued by Hartzog, there is also a vast difference between the expectations of the consumers and what the robot can actually do⁴¹⁴. It is important to know what consumers expect from a person carrier, and if this is stated clearly enough from the creator. As person carriers (as well as wheelchairs) will start incorporating several features, e.g. a robotic arm to feed elderly, it is also important to advertise it accordingly and avoid misleading information.

This highly affects consumer robotics and thus the protection of users. And this has a European dimension, because in Europe products that comply with harmonized standards are assumed to meet the essential requirements of products, i.e. presumption of conformity with the CE marking. Resyone is a device that, for its intended tasks and own capabilities, should have followed another risk assessment. This is a problem that concerns the “certified safety”. In fact, sometimes the certification is obtained without testing the quality of the product itself, only by controlling that all the necessary steps have been met⁴¹⁵. This causes a problem, first for the consumers, but also to the creators

two different types of standards and both were the ones that had to be applied for this mobile servant robot (with no manipulator).

⁴¹¹ Numbers 60, 67

⁴¹² Hartzog, W. (2015). Unfair and Deceptive Robots. Presented at WeRobot 2015. Available at: www.werobot2015.org/wp-content/uploads/2015/04/Hartzog-Unfair-Deceptive-Robots.pdf

⁴¹³ Advertising and Marketing on the Internet FTC (2000) Available at: www.ftc.gov/system/files/documents/plain-language/bus28-advertising-and-marketing-internet-rules-road.pdf

⁴¹⁴ Hartzog op. cit. p. 10.

⁴¹⁵ See Le Monde (2012) Le label "TÜV", une institution en Allemagne [*The Label TÜV, an institution in Germany*]. Available at: www.lemonde.fr/societe/article/2012/01/03/le-label-tuv-une-institution-en-allemande_1625117_3224.html#s0Uy41QPZYhddLsv.99.

of the robot: certification agencies do not have any responsibility after they have granted the certification, and the European Parliament tends to hold roboticists accountable for the damage caused “for present and future generations”⁴¹⁶ (see liability section).

Again, this scenario leads to a fundamental conclusion: the more and more we will need dynamic standards or regulations that can cope with robots that transform into other robots. The segway that transforms into a companion robot will need to be assessed according to both the person carrier and the mobile categories. Another more complex example will be other cases that include robots from different categories or legislations, e.g. robot prosthetics that incorporate a drone as the Alternative Limb Project did in the Phantom project⁴¹⁷ or projects that overlap the personal care and the medical device category. Therefore, a person carrier that is capable of monitoring the user’s vital signs, such as measuring blood pressure or heart rate, either directly or indirectly (through wearable devices worn by the patient), should be assessed according to the medical device legislation. At the moment, however, there is no answer or guidelines from the major institutions, i.e. FDA or EU Commission, in this regard.

In any case, robotic devices cannot be in a grey zone in terms of legislation. The project between Intel and Dr. Hawking to create an IoT wheelchair could be an example of this⁴¹⁸. Robotic wheelchairs are not considered medical devices in general, only the stair-climbing robot in class III is considered so. This wheelchair allows people to know the wheelchair accessible places, the status of the wheelchair itself, but also, and most importantly, the wheelchair is capable of measuring the health status of the user including body temperature or heart rate. The evolution of these devices will make re-think what can actually be included in the category of medical devices (and of course, personal care robots). Also, there are robots that will not be strictly related to the medical device regulation but that will perform tasks according to the biomedical data collected by some wearable devices, e.g. call a doctor based on the information a wearable device has given to the robot. If this is the case also for person carriers, it will then be necessary to think what appropriate legislation governs them. As we will see also in the user’s rights section, if the robot does not control this data but processes it, it will be considered a data processor and appropriate measures that affect the consumer protection according to the data protection will have to be met.

Due to the rapid development of robotic technology and the mixing categories we have seen, this is still a fundamental unsolved problem. A clear definition of the context and the robot type could help determine the correct categorization of the legal framework to be applied. Although the medical device regulation has a long tradition of the “intended use”, what makes more sense is to make a robot compliant with the legal system through a combination of variables: by its own capabilities, the context where it is inserted and its HRI. In order to avoid under-/over-regulated scenarios, a sort of personalized dynamic legislation would be needed. This is what the Consumer Product Safety Commission (CPSC) tries to do. Although it is not yet personalized or dynamic, it could be the beginning of this personalized dynamic regulation.

⁴¹⁶ See 2015/2103(INL) European Parliament Resolution on Civil Law Rules on Robotics (May, 2016), p. 16.

⁴¹⁷ See www.thealternativelimbproject.com/project/phantom-limb/

⁴¹⁸ See www.intel.com/content/www/us/en/internet-of-things/videos/dr-hawkings-connected-wheelchair-video.html and also see www.theverge.com/2014/9/11/6134671/stephen-hawking-shows-off-intels-connected-wheelchair.

We ran the CPSC's Regulatory Robot for wheeled passenger carriers. In the Annex I there is the report and the screenshots of the procedure for wheeled passenger carriers. We ran the software thinking about the i-Resyone. The first thing we did was to name the project. We chose the name "wheeled passenger carrier". First question was whether the product was a "consumer product" or not, and we concluded it was. The second question was whether it was a children's product, which was not⁴¹⁹. i-Resyone is not also part of clothing or an art material. After these 3 questions, the system already advised that 50% of the process was already completed. Then, a question related to packaging appeared (to which we answered no) and then, even if a comprehensive list of "general use" products was given, we ended up saying "none of the above". Regarding the household electrical products, we also replied no (because i-Resyone is not a hairdryer, a season holiday lighting or an extension cord). Then, after stating that we were already at the 75% of the process, a question concerning the Federal Hazardous Substances Act was made. After stating that our product could not be considered toxic, corrosive, etc. a report was generated by the system.

Beyond the fact that we might have missed something (like that some of the components of the system might be considered hazardous), what is most surprising is that in 2016 this software cannot help with the creation of this precise technology. Although the legal dimension of these products may be uncertain and consequently it may be difficult to determine the applicable laws, these products are entering already the market (Segway® for instance), and creators building similar technologies would need further insight. Furthermore, there are other sides of the protection of consumer law (e.g. fraud, privacy, data security, failure to exercise reasonable care or exploitation of the vulnerable as Hartzog says) that could have been included into the system so as to offer a full legal coverage to citizens.

4.3. Liability

«Going to the garden with the person carrier, Anna accidentally runs over a child that was visiting her grandma. The mother of the child sued Anna for damages. Anna claimed responsibility to the nursing home, but this latter argued in court that it was the person carrier's fault because it worked autonomously. The manufacturer says that once the warranty expires, they are not responsible for it»

The right to the integrity of the person, the right to an effective treatment and the rights of the elderly and of people with disabilities are considered Fundamental Rights by the European Charter of Fundamental Rights (see articles 3, 25, 26, and 47); from the legal point of view, the occurrence of harm is the basis for liability.

Internal control failure of the system as well as external factors (weather conditions, a hole in the street, etc.) can cause direct harm to the users, for instance, causing them to tip over. This is very important because tipping over is one of the first sources of risk for the person in wheeled passenger carriers. Although referring to wheelchairs, two decades ago 77.4% of wheelchair users died because they had fallen from their

⁴¹⁹ It is worth saying that when we were investigating this sub-type of personal care robots and we came across with the Go-Baby-Go project of prof. Galloway (2008) op. cit. we ran the regulatory robot, and found out that for the type of robot he was using (toy cars used as rehabilitation wheelchairs for 0-3-year-old children) the system could not help neither. Again, the transformation of technologies and the new uses of these are difficultly reflected in the search engine of the CPSC.

chair⁴²⁰. In the above-mentioned case scenario, this could be the case of Resyone (or the hypothetical i-Resyone if the same safeguards have applied) because travel instability or incorrect use have not been taken into consideration.

There are many different person carrier models: some will be for one person, with no cabin, others on the contrary will be like 3-D printed autonomous person carriers that can be used for community transport and that obviously incorporate a cabin⁴²¹, like the ones in the Schiphol Amsterdam airport. For autonomous person carriers employed in a closed circuit (like an airport) the risk of harm is minimized. An example could be person carriers in Masdar city: they travel without third parties contact and they have not presented problems so far (*see* fig. 8). In these cases, it seems liability should be constructed as it has been until now, under Article 7 letter (e) of the European directive 85/374/CE for product liability.



Figure 27 Masdar City Carriers. Source: techgenmag.com/2015/07/step-inside-masdar-city/

The problem of person carriers comes when the degree of human-robot interaction is higher (not only with the user but also with third parties), when the device operates in unstructured environments, and depending on whether it functions fully autonomously or in shared control.

Let's consider the Charlotte nursing home as an example. Until now, robotic technology has been included in hospitals *ex novo*, that is, in new buildings where the inclusion of this technology was already planned. As we explained before for AGV vehicles, hospitals that incorporate these systems have prepared their facilities accordingly, they have created corridors for the robots, elevators solely used by robots, etc. The HRI with users (patients in the hospital) is minimum. Also the contact with the personnel at the hospital is quasi minimal: when the kitchen staff has prepared a trolley with the food trays, a person puts it into the boarding area and a robot is

⁴²⁰ Calder CJ (1990) Fatal Wheelchair-Related Accidents in the United States. *Am J Phys Med Rehabil* 69:4, pp.184-190.

⁴²¹ Warren, T. (2016) This autonomous, 3D-printed bus starts giving rides in Washington, DC today. *The Verge*. *See* www.theverge.com/2016/6/16/11952072/local-motors-3d-printed-self-driving-bus-washington-dc-launch?utm_campaign=theverge&utm_content=feature&utm_medium=social&utm_source=twitter

autonomously called. Then the robot comes, takes the trolley with the food and goes to its intended destination, another boarding area. The robot leaves the food and goes away to perform its following task. The staff might never see the robot. Instead, when a person is present and there is an imminent collision, several sensors lead the robot to a protective stop (although most of the robots only have frontal and back sensors, and not side sensors).

The nursing home Charlotte, on the contrary, is based on already-existing facilities, i.e. buildings that were not conceived to accommodate robot technology (as it happens in the majority of the hospitals nowadays). The nursing home wants to use robot due to a shortage of public funds⁴²². In order to reduce costs, this nursing home incorporates the robotic technology without many changes to their buildings. Although this is a fiction scenario, it is true the fact that soon more technology will be applied in hospitals and in nursing homes not only from the surgery perspective (Da Vinci robot) but also from the service robot perspective. This means that modeling the space between humans and robots (what has been called proxemics) will be crucial, especially to avoid scenarios where the robot stops every now and then due to crowded spaces. Although nursing homes tend to be structured environments, the fact that they will be sharing the same space with robots will force robot creators to take into consideration also this scenario.

This is linked to autonomy and to unstructured environments. Person Carrier Robots, like other kinds of robots, will have to face non-mission tasks, especially in unstructured environments like the street or the homes of the users. If the context of i-Resyones is shifted to an outdoor context everything becomes more unpredictable, especially if the carrier works in an autonomous mode. If the carrier works in autonomous mode in unstructured environments, deep map technologies could help robot creators avoid further liability scenarios. Used by Google cars, the project “ground truth” provides the logic of places, no-left turns, traffic rules, etc. The idea is to fill the gap what we see in the real world and the online world⁴²³. This somehow can look impossible for robot creators, but the exemption of responsibility has a condition, that is: “the state of scientific and technical knowledge at the time when he put the product into circulation was not such as to enable the existence of the defect to be discovered”. If the technology already exists, and producers of person carriers that go around unstructured environments autonomously are being built, this should be taken into account. Furthermore, maybe in the future not all this information will have to be used, mandatorily, for autonomous navigation. The truth is that Google car does not process all the information from scratch⁴²⁴. They have created some sort of smart maps that can give very precise information to the car, including the height of traffic lights off the ground, the exact position of curbs and also speed limits, in order to provide the car with a sort of “empty-car” map. This way, their algorithms can work not from the scratch but from the ideal already created map.

Some person carriers have similitudes with autonomous driving cars, especially if they are autonomous and work in unstructured environments: they will have to face unpredicted tasks. That is why liability framework for some person carriers should be similar to them. In 2012, Marchant and Lindor proposed that the creator of the robot

⁴²² Although this is a fiction scenario, it is true the fact that more technology will be applied in hospitals and in nursing homes not only from the surgery perspective (Da Vinci robot) but also from the service robot perspective. This

⁴²³ See www.theatlantic.com/technology/archive/2012/09/how-google-builds-its-maps-and-what-it-means-for-the-future-of-everything/261913/.

⁴²⁴ See <http://www.theatlantic.com/technology/archive/2014/05/all-the-world-a-track-the-trick-that-makes-googles-self-driving-cars-work/370871/>

should assume the responsibility⁴²⁵. In 2015, major car companies accepted liability for any damage their autonomous vehicles would cause⁴²⁶. And in 2016, the European Parliament established that strict liability rules should apply for robot technology and that creators of robots should remain accountable for their creations. Maybe the roboticists creating person carriers should assume responsibility for their creation as well as. Insurance companies should also be aware of this if a mandatory insurance scheme is created.

It is true however that, again, the responsibility framework depends enormously on the type of robot and the context where this is going to be incorporated (new/old building, in/outdoor, etc.). Wheeled passenger carriers that are similar to i-Resyone, if used in indoor contexts, largely differ from segways®, segways that transform into mobile servant robots, personal rapid transit vehicles or others considered person carriers. That is the problem of the EU Parliament resolution: although its statement on responsibility is quite clear, it does not take into account several other factors that could challenge its strict liability approach. The shared control mode, for instance, plays a major role on the allocation of liability and it should be taken into consideration, not only because it has been found that in certain carriers it is preferable (as we already mentioned in the safety section) but also because there is a tendency to use decision-support systems in other robotic technologies that can be also incorporated to person carriers⁴²⁷. Thus, although roboticists will still have to be *responsible* for their creations, they might not be held *liable* or legally responsible in certain cases, especially in shared control modes.

That is why for instance some have thought about issuing a driving license (as we mentioned already and to share responsibility); and why black boxes and testing zones will gain much more importance. The Human Engineering Research Laboratories (HERL) at the University of Pittsburgh is one of the examples of these testing zones. HERL is a testing laboratory to perform many of the ISO and the American ANSI/RESNA Standard tests for powered wheelchairs and lower-limb prosthetic devices⁴²⁸. The problem of this center is that it only tests powered wheelchairs (so, medical devices), but not other carriers. Maybe in the future some person carriers will have to be tested in similar centers (because wheeled passenger carriers can be very similar to wheelchairs) but definitely there is the need to create a center that can test all these technologies. Seen the growing tendency to create drone airports in order to stay away from airplane airports and practice with them⁴²⁹, as well as other Tokku Zones for robot testing as we have already mentioned, person carriers will have to be tested somewhere, especially if they work similar as the autonomous vehicles.

Black boxes, already used in several robotic devices, are a measure that could help tackle liability issues a posteriori. In fact, there are authors that consider that any autonomous vehicle (which would include person carriers) should incorporate a black box⁴³⁰. Black boxes can record the driving history of the device, which can be used for

⁴²⁵ Marchant, G. E., & Lindor, R. A. (2012). The coming collision between autonomous vehicles and the liability system. *Santa Clara Law Review*, 52(4), 1321–1340.

⁴²⁶ See Ballaban, M. (2015).

Mercedes, Google, Volvo To Accept Liability When Their Autonomous Cars Screw Up. *Jalopnik*. <http://jalopnik.com/mercedes-google-volvo-to-accept-liability-when-their-1735170893>

⁴²⁷ We are talking, again, about the project that L. Herlant is conducting at CMU, or for instance the project perMMA conducting at the Human Engineering Research Laboratories at the University of Pittsburgh (*see* www.herl.pitt.edu/research/permma).

⁴²⁸ See <http://www.herl.pitt.edu/research/wheelchair-testing>

⁴²⁹ Like the airport at the University of Twente, *see* droneairporttwente.com.

⁴³⁰ See Vasic, M., & Billard, A. (2013, May). Safety issues in human-robot interactions. In *Robotics and Automation (ICRA), 2013 IEEE International Conference on* (pp. 197-204). IEEE.

robot forensics. Similar to the study of Hong et al. the evidence for a trial could be collected from the robot black box using a smartphone⁴³¹. Then it would be easier to decide who is responsible for an accident that could finally involve several parties. Although some authors already said that black boxes are *opaque* because their inner working is often hidden⁴³², restricted access to those black boxes or encryption should be implemented to avoid privacy infringements. From the legal perspective, it should then be important to recognize the use of this evidence as prove in trials.

Another possible solution to solve the responsibility issues (and that could be applied to other types of robots) is the use of a system similar to the International Commercial Terms (INCOTERMS), but of course applied to robot technology. Published for first time in 1936 by the International Chamber of Commerce, they are internationally accepted definitions and rules of interpretation for most common commercial terms used in contracts for the sale of goods⁴³³. There are some videos in Youtube where the rules for responsibility of international traders are explained in a very specific manner⁴³⁴. Although there is no literature at this regard, we believe that if there was a system that could be equally explicative concerning not only who has been involved in the robot development but also concerning the robot behavior (what parts are autonomous, semi-autonomous or tele-operated), then the attribution of responsibility could be easier. This could be in line with the self-explicative system of the robot that Johnson mentioned, but also it could go on a more distributive or responsibility approach which has not been fully considered.

4.4. User Rights Safeguard

«Queen Charlotte has currently 134 residents. Although the carriers need to be shared, they are personalized: when Anna takes it, the carrier knows that at 4pm her daughter comes to the nursing home, at 5pm she has the hairdresser and at 5:30pm she goes the dining room. The system collects information about their outdoor rides and other carriers, so converging behaviors can be inferred»

Prima facie it looks as if privacy was not a major concern for person carriers, as their primary use is not related to the invasiveness of the users' private life but rather to simply convey them to an intended destination. However, and similar to the opinion 02/2013 on app on smart devices, unawareness of data protection requirements may create significant risks to the private life of the users also in robotics⁴³⁵.

Depending on the technology applied to the person carrier, indeed, the users' privacy could be undermined. For instance, obstacle recognition through cameras can pose privacy at risk if cameras record other things rather than the obstacles to avoid, especially if the user's private information or the data of third parties are recorded. A more crucial aspect, however, will be what the cooperative driving will bring about⁴³⁶:

⁴³¹ Hong, C., et al. (2011, January). Evidence collection from car black boxes using smartphones. In Proc. of Consumer Communications and Networking Conference (pp. 836-837).

⁴³² Resnick, M. et al. (2000) Beyond black boxes: Bringing transparency and aesthetics back to scientific investigation. *The Journal of the Learning Sciences*, 9(1), 7-30.

⁴³³ Extracted from: iccwbo.org/resources-for-business/incoterms-rules/

⁴³⁴ See, for instance, www.youtube.com/watch?v=SDQrLcbeJBY

⁴³⁵ See Article 29 Working Party Opinion 02/2013 on apps on smart devices, available at: ec.europa.eu/justice/data-protection/article-29/documentation/opinion-recommendation/files/2013/wp202_en.pdf

⁴³⁶ This is how it was called in Inriality in an article about the cars of the future (*les voitures de demain* in French). See <http://www.inriality.fr/transport/autonobile/voiture/les-voitures-de-demain/>.

data gathering, lack of user awareness (track of each ride, position where it is, time spent on it, schedules, etc.) and robotic decision-making process (even of ethical/moral dilemmas) among others. As Calo argues, robots are capable of recording every data about the user and the environment, which could be of extraordinary use in both loss prevention and marketing research⁴³⁷.

It cannot be taken for granted that the IT systems incorporated to the device are secure just because they are being released into the market. Similar to what we said about the certified safety, in a newspaper article, Valasek and Miller admitted that they hacked a Jeep “altering its code to remotely control its air conditioning, radio, windshield wipers, transmission, braking and steering”⁴³⁸. Furthermore, even if the user is aware of the collection of data and has given the consent, it will still be hard to ensure that the user’s consent was informed.

Most of the jurisdictions allow the processing of data whenever the subject has given the (informed) consent and in other exceptions. But consent in person carriers brings about some problems: a) the majority of the users are not even aware of the fact that their data is being processed; b) the meaning of “informed” consent is not very clear; c) as well as until what extent the users consent the process of data:

- a. The principle of fairness actually requires the awareness of the data subject to collect data lawfully. Failing to do so makes the processing unlawful and has consequences for the data controllers, such as the duty to give compensation to the data subjects, or all the sanctions provided in the national legislations (until 2018 when the 2016/679 Data Protection Regulation will enter in force). However, the reality shows that, in order to move around autonomously, a person carrier needs to process a lot of information. This information can later be used for profiling, especially if the carrier is personalized and it is shared among the users of the nursing home. The amount of collected data, therefore, surpasses other type of data collection that work on a one-purpose/one-consent basis. This entails, most of the times, infringement of the right to the privacy⁴³⁹.
- b. The user not only needs to be aware of the collected data, it also needs to give the consent, especially if there is sensitive data at play (because they are regulated more stringently). If the informed consent has already its own barriers, e.g. language, religious or false expectations⁴⁴⁰, the problem increases when the interactions are delegated to smart devices as the collection of information not perceptible to everyone⁴⁴¹, either because the technology incorporated into the carriers is small and invisible to the user or because the user is not aware of what precise data is collected. In fact, the use of the device should not imply granting a general informed consent, as it happens now when a person enters a surveilled area⁴⁴². The problem is how to ensure a meaningful consent in this

⁴³⁷ Calo, R. (2012) op. cit.

⁴³⁸ Protect Driverless Cars from hackers (like us), article found in: time.com/4037381/valasek-and-miller-driverless-cars-accelerate-or-brake/?xid=homepage.

⁴³⁹ See de Andrade, N. N. G. (2010). The Right to Privacy and the Right to Identity in the Age of Ubiquitous Computing: Friends or Foes? A Proposal. *Personal Data Privacy and Protection in a Surveillance Era: Technologies and Practices: Technologies and Practices*, 19.

⁴⁴⁰ See Nijhawan, L. P. et al. (2013) Informed Consent: Issues and Challenges. *J Adv Pharm Technol Res*, 4(3), pp. 134-144.

⁴⁴¹ See Big Data and Smart Devices and Their Impact on Privacy (2015) DG for Internal Policies. Policy Department. Citizen's Rights and Constitutional Affairs. Available at: [http://www.europarl.europa.eu/RegData/etudes/STUD/2015/536455/IPOL_STU\(2015\)_536455_EN.pdf](http://www.europarl.europa.eu/RegData/etudes/STUD/2015/536455/IPOL_STU(2015)_536455_EN.pdf)

⁴⁴² Nowadays, parking areas only include a sign that the area is being surveilled. The consent of the person to be surveilled is implicit by the fact that the person enters the area.

ubiquitous paradigm⁴⁴³, where users cannot know how their information will be processed or utilized in the future⁴⁴⁴. This connects with the idea that not everyone would like to give the consent for the same use or for the same technology. If there is no dynamism in the current consent schema, it will not be sure how accurate this informed consent will be.

- c. This idea is also linked with the “specified, explicit and legitimate purpose” of the Data Protection regime. There is the obligation for the data controller to specifically mention why and for what purpose they are collecting the data, especially such data may have secondary uses, in sensor fusion for instance. As the A29WP remarks, either for “raw, extracted or displayed” data, the controllers need to make sure that the used data is compatible with the original consent. If there is the intention to collect data for research, the controllers not only need to clearly state it⁴⁴⁵, they also need to have the consent of the user and set down all the appropriate safeguards to cope with that⁴⁴⁶.

Another problem is the problem of sensor fusion and the third use of the collected data. This implies the loss of control over the data, both personal and non-personal; and opens to the possibility of a post behavioral analysis⁴⁴⁷. The principle of transparency should play a major role here, but the intrinsic labyrinthian structure of the data flow between devices, between devices and back-end systems, providers and manufacturers, makes it practically impossible to track it. Tracking data is a key element for accounting reasons as well as for liability scenarios (e.g. black boxes) but the more the data collected, the more difficult it is to discover its flow. In theory, the data minimization principle, which derives from the proportionality of data processing, should take place to make this process more transparent; however, appropriate actions are difficult when collectors of data have the intention to process as much information as possible⁴⁴⁸.

Since person carrier robots at Queen Charlotte are shared among different users, the devices need to incorporate profile modules to identify each user and also to personalize the device (according to the user’s preferences). If the person carriers are personalized:

- First, they will need to be protected against vandalism acts and include a password or some bionic identification system to avoid a possible misuse (as ISO 13482:2014 suggests) although this does not come without fault⁴⁴⁹.

⁴⁴³ See Office of the Privacy Commissioner of Canada (OPC) Guidance Documents (2012) Seizing Opportunity: Good Privacy Practices for Developing Mobile Apps. Available at: https://www.priv.gc.ca/information/pub/gd_app_201210_e.pdf

⁴⁴⁴ See Office of the Privacy Commissioner of Canada (OPC) Guidance Documents (2014) Wearable Computing. Challenges and Opportunities for Privacy Protection. Available at: https://www.priv.gc.ca/information/research-recherche/2014/wc_201401_e.pdf

⁴⁴⁵ As some companies are already doing, see www.proteus.com

⁴⁴⁶ See Art. 6.1.b) of the EU Data Protection Directive: “further processing of data for historical, statistical or scientific purposes shall not be considered as incompatible provided that Member States provide appropriate safeguards”

⁴⁴⁷ Hon, W. K. et al. (2011) The Problem of 'Personal Data' in Cloud Computing - What Information is Regulated? The Cloud of Unknowing, Part 1. International Data Privacy Law 1 (4): 211-228; Queen Mary School of Law Legal Studies Research Paper No. 75/2011. Available at: <http://ssrn.com/abstract=1783577>

⁴⁴⁸ That is what IBM or Google are doing. Google’s mission for instance is to organize the world’s information and make it universally accessible and useful. Information available at: <https://www.google.com/about/company/>.

⁴⁴⁹ Attention should be drawn to recent stolen fingerprints in the United States Government See the BBC (September 2015) Millions of Fingerprints Stolen in the US Government. Available at: www.bbc.com/news/technology-34346802

- Second, and because of the General Data Protection Regulation, the device should allow data-portability⁴⁵⁰ because if it breaks or the producer stops producing it (as happened with the iBot project⁴⁵¹) the users should have the possibility to easily transmit setting information and their preferences to a new carrier. This is going to be fundamental for elderly or disabled users because it may be possible that when that happens, the user's impairment has worsened and cannot re-train the carrier as previously done with the prior wheelchair.
- Third, all the information collected should be used only for the proper functioning of the device and not for other reasons, e.g. increasing the knowledge of the person carrier provider to ameliorate it, or other business-related issues such as: selling new components to compensate some failures, selling some new gadgets to be incorporated to the carrier like a robotic arm, etc.

As we have seen in safety and will also see it in the dignity/ethics section, person carriers incorporate a protective scope when there is a failure of the system or this detects that the person could be in danger. However, there is not a protective stop for data protection or privacy matters. Some of the latest robotic technologies are always on, always tracking every single movement. For the sake of safety (because the carrier needs to process a lot of information in order to avoid collision) we might be giving away our privacy constantly, as these devices, again, cannot stop collecting the information about the user or their environment. Maybe an opt-in mode should be included so that it is the user that decides whether to participate or not into the collection of data. However, the company defends this data collection by saying “the device uses your data to provide you a perfect and safe drive”⁴⁵².

4.5. Autonomy

«Thanks to the carrier, Anna feels young again. The carrier brings her wherever she tells to, goes outside with it and has not to worry because she uses autonomous mode all the time. She feels constrained, however, for the timetables and sometimes obliged to go to dinner because the carrier does not stop beeping until she takes it back to the nursing home. One day she did not want to go back to William St. because she had other unscheduled plans. The carrier went back to the nursing home in any case»

As we have seen, autonomy can be understood both from the robot perspective (the behavior of the robot) and from the user's perspective. If we stick to the definition given by RoboLaw project, i.e. independence as the ability to manage ADL and satisfy personal needs by oneself, the Person Carrier Robots of the Queen Charlotte nursing home allow users to be more independent. In fact, other person carriers for general use might also contribute to the independence of their user, as these devices are not programmed to provide any personal care on behalf of the user.

⁴⁵⁰ European Regulation 2016/679 on the protection of natural persons with regard to the processing of personal data and on the free movement of such data, and repealing Directive 95/46/EC (General Data Protection Regulation).

⁴⁵¹ The iBot project was a powered wheelchair that had great success in the United States but that ended its production for cost reasons. *See* more info at: en.wikipedia.org/wiki/IBOT#Production_Ends

⁴⁵² For more information on the cookie policy, *see* ec.europa.eu/ipg/basics/legal/cookies/index_en.htm. For an article stating the facts why this law “was not fully baked” *see* Kobie, N. (2015) Why the cookies law wasn't fully baked – and how to avoid being tracked online. The Guardian. *See* www.theguardian.com/technology/2015/mar/19/cookies-how-to-avoid-being-tracked-online

A way of respecting this user's independence is to apply machine-learning capabilities to the robot: the robot could learn from the patient's daily routine and take it as a frame of reference for future scenarios. This could entail a lightening in the decision-making computing weight, but of course it could imply much more behavioral data analysis.

User's decisions about their welfare state and the robotic device as much as possible should respect their daily routine. This could clash with the rules of third parties such as the nursing home in this case. Thus, it should be discussed between the nursing home and the user of the carrier, what is respected and what is not, to better accommodate all the interests. For instance, if Anna is outside with her family, and it is dinnertime in the residence, it should be clearly stated whether she can or not remain with her family or if the carrier should beep until she gets on and goes back to the residence. Other types of carrier, like multiple-passenger carrier, that work between a car and public transport, will probably have not this problem, as they are programmed to move around intended destinations and may work regardless of the user's preferences (similar to unmanned undergrounds) or totally under the user's preferences (similar to an Uber/Lyft⁴⁵³).

In any case, declining mobility and worsening memory should not justify per se user decision-making substitution when the robot is in shared control mode and used in outdoor contexts, unless it is stated that the person is cognitively impaired. A supervised autonomy has been considered in order to provide safety margin when the system is uncertain on how to proceed before a non-mission task. This system, called "automated transport and retrieval system (ATRS)" works for mobile robotics in outdoor contexts that operate in the vicinity of the premises of the robot – the nursing home in this case⁴⁵⁴. According to Gao et al., the HRI is essential to system robustness and can help human integration.

The technical determinism that leads current robotics, i.e. that society responds more to technology than technology responds to society, implies social concerns and different acceptance rates among society⁴⁵⁵. Next editions of ISO 13482:2014 will take into account special part of the population such as children or elderly. This is important in order to fulfill the user's expectations if the robot will be personalized.

Although no report stating a dependence on this type of technology has been found, the autonomy and independence of the users needs to be balanced with the dependency the users might have on the device. Generally speaking, person carriers are well accepted among users, especially wheeled passenger carriers. Other types like segways® are also widely spread. We will have to wait until person carriers evolve in order to know what is the level of autonomy on the decision-making process and the connectivity of the devices (internet of things).

4.6. Dignity

« The inclusion of i-Resyones increases the efficiency of the nursing home, and workers can take care of other more important things. Anna starts feeling down, however, because she realizes that the time spent with the caregivers is less and less. She barely has human contact now during the week»

⁴⁵³ These are the two main companies offering these services, at least in the U.S. More information on Uber at: www.uber.com. More information on Lyft: www.lyft.com

⁴⁵⁴ Gao, C., et al. (2008). Autonomous docking of a smart wheelchair for the automated transport and retrieval system (ATRS). *Journal of Field Robotics*, 25(4), 203.

⁴⁵⁵ Frennert, S. and Östlund B. (2014) Review: Seven Matters of Concern of Social Robots and Older People, *Int J of Soc Robotics* 6:299–310

A person carrier that could incorporate an industrial arm to help users be fed would increase the dignity of the user. Some researchers at Carnegie Mellon University are working on a project called Assistive Dexterous Arm (ADA), a wheelchair-mounted robotic arm where they are being developing the feeding function, including the arch movement into the robotic arm⁴⁵⁶.

Dignity also includes aspects such as the fear of the replacement of humans through robot technologies, the replacement of human emotions as well as exclusion contexts. Concerning the latter, some researchers believed that the sophisticated presence of robots, (mainly mobile servant robots because they can talk back to the person for instance), could lead to some isolation scenarios. Person carriers, however, do not offer any special/sophisticated presence. This does not mean that the isolation scenarios cannot come along, as it seems that bulkiness of the carrier and weather conditions can pose some isolation problems in this context. Person carriers that can restrictively be used in several contexts such as on holidays, in other friends' house, in other buildings or in snowy terrains, can pose a major barrier to the user.

Some pseudo-roboticists tried to solve these isolation issues in a down-to-earth manner: Soden, a veteran with no engineering background has created the Tankchair, a person carrier that can be used in all terrains: snowed, grassed fields, etc.⁴⁵⁷. This could promote sociability regardless of the weather condition. The shape of it can be a problem for the easiness to carry on vacation or to a friends' house (it is actually very big). A practical solution could be to work on its shape and weight and to make it transportable. Another option would be to connect the carrier to the internet so as to change its own parameters according the weather forecast (using any weather platform). This way the carrier could autonomously decide not to go out that day because of the weather conditions or could calculate a different route based on this condition. An appropriate balance should then have to be established in order to let the user know the intention of the carrier and to align it with the intentions of the user.

Perhaps next-generation person carrier robots will be close to social assistive robots like mobile servant robots⁴⁵⁸. If this will be the case, they will provide "enhanced presence" due to interaction and reactive behavior. The upper level of presence, "sophisticated presence" will be a combination of social assistive robot and a smart home, like ACCOMPANY Project's Care-O-Bot®⁴⁵⁹. Presence, enhanced presence, and sophisticated presence are complicated scenarios where robots interact to make the relationship with the patient mutual and in some ways empathetic.

Person carrier robots are not so far suitable for therapy or company. This is limited to socially assistive robots that can play different roles: helpers, enablers, co-learners and companions. A list of social robots and their functionalities is available in the work of Robinson et al.⁴⁶⁰. Probably, next-generation Person carrier robots will also include some assistive robots' capabilities as the project presented by Intel and Professor Hawking. To this respect, some caregivers are skeptical about using social robots for impaired and disabled people and for therapy purposes. The reason is that care in these

⁴⁵⁶ The main researcher under this project is Laura Herlant at Carnegie Mellon University www.ri.cmu.edu/person.html?person_id=3157.

⁴⁵⁷ See: www.huffingtonpost.com/2014/06/05/tankchairs-for-people-with_n_5454686.html; extracted from the project www.tankchair.com.

⁴⁵⁸ As the example given before of the segway that transforms to a mobile servant robot.

⁴⁵⁹ Reiser U et al (2013) Care-O-bot® 3 – Vision of a Robot Butler. In: Trappl R (ed) Your Virtual Butler, LNAI 7407, pp. 97–116.

⁴⁶⁰ Robinson H. et al (2014) The Role of Healthcare Robots for Older People at Home: A Review, *Int J of Soc Robotics* 6:575–591.

cases requires being individualized to the needs of the user. In many cases caregivers, as mentioned before, provide the only human interactions with non-disabled people users⁴⁶¹. Nonetheless, robots are starting to be used to interact with children with autism⁴⁶². A pet-shaped robot or a companion robot can also have some therapeutic benefits.

Concerning the replacement of human workers, person carriers would not necessarily substitute persons. In a recent study in Japan, however, caregivers were worried about the decrease in their volume of activity because of the insertion of robotic wheelchairs. They argued that “moving support from an autonomous wheelchair robot might decrease opportunities for rehabilitation” adding “if seniors become dependent on such a robot and stop moving by themselves, their own physical activity will decrease”⁴⁶³. This could be one of the reasons of human-human contact decrease.

In the given example, and very similar to what happens with AGV, the employment of robot technology from Queen Charlotte could replace human workers. The i-Resyone case was inspired by some of the AGV found in the Hospital Universitario Central de Asturias (HUCA). If we see Fig. 10, two women are dragging a pallet of 125 kilos. AGV can bring up to 500 kilos with no pause for coffee, no cigarette pause and no salary.



Figure 28 Effect of the employment of robot technology. Picture taken in Hospital Universitario Central de Asturias, Spain.

In Queen Charlotte it is true that these person carriers will make care more efficient, and caregivers will have more time to spend with the patients doing therapy, listening to them, etc. Some of the workers at HUCA argued, however, that the inclusion of this

⁴⁶¹ Wolbring G. et al (2014) Social Robots: Views of Staff of a Disability Service Organization, *Int J of Soc Robotics* 6:457–468.

⁴⁶² Barco, A. et al. (2014, August). *op. cit.*

⁴⁶³ Shiomi M et al (2015) Effectiveness of Social Behaviors for Autonomous Wheelchair Robot to Support Elderly People in Japan. *PLoS ONE* 10(5), pp. 1-15

technology complements the lack of workers. Since there have been several shortcuts in the healthcare system and caregivers were fired, employers started using the excuse that the inclusion of robot technology was a strategy to improve healthcare. Another of the concerns of the workers was the fact that this hospital was brand new and that everything was well thought from the very beginning. Older hospital have no corridors or elevators for robot, nevertheless some of these autonomous systems (AGV or i-Resyones in our case) can be incorporated in an already existing building without much modification of the environment. For workers it was clear: robots were taking their job.

Other types of person carriers, such as those for collective transport, will pose the question whether bus drivers will be also substituted. Recently not only was one bus printed in a 3D printer, but also it works autonomously on an IoT platform (*see* Fig. 10). Although the responsibility for this fact (or the *accountability* that the Parliament stated for the impacts of this technology to present and future generations) should not fall solely on personal care robots builders, it is true that all of them contribute to the creation of these autonomous systems than can replace human figures. Whether humans will accept the balance in favor of autonomous driving (for its benefits, e.g. the decrease on the world death rate), it is still an ongoing discussion. In any case, besides technicalities regarding these robots, also the impact at the social level (allocation of human workers) needs to be considered.



Figure 29 IBM Watson IoT 3D Printed bus. Source: Engadget⁴⁶⁴

Person carriers in any case do not contribute *per se* to the feeling of loneliness. If in the future this robotic technology will include more social characteristics (incorporating communication capabilities for instance), they could lead to more isolation scenarios (and they could be considered social robots, as we mentioned in Chapter 1).

⁴⁶⁴ See www.theverge.com/2016/6/16/11952072/local-motors-3d-printed-self-driving-bus-washington-dc-launch and also www.engadget.com/2016/06/16/olli-driverless-ev-local-motors-ibm-watson/

4.7. Ethics

«One day, tired of living, Anna decides to fall down the stairs with the carrier. The person carrier prevents her from doing so and reports to the nursing home this strange behavior»

Current Person Carriers have not evolved as much as to consider them as ethical autonomous agents although they can be involved in certain dilemmas. Currently, new person carrier prototypes are being created in research labs and they are entering the market. The more capabilities these devices will include, the more complex the legal framework. Indeed, if the person carrier includes some high sophisticated HRI, further capabilities and it is connected to the environment, then more aspects will need to be analysed.

Similarly to what Sharkey and Sharkey wondered in 2010⁴⁶⁵, what could happen if a user asks the person carrier to go down the stairs and allow him/her to fall? Should the person carrier prevail the safety of the user?

Although robots have also a positive effect on stress relief⁴⁶⁶, roboticists will need to pay attention to all these other aspects of the technology, especially if the ethics by design principle is implemented⁴⁶⁷. For instance, suicidal requests should be prevented from robots at risk of misinterpreting humans' requests. Aborting an activity requested if the robot detects the user has fallen or if her vital signs have suddenly and significantly changed (and of course informing a caregiver of it) could also be adopted. And although robot technology should be created in a way to respect human dignity and human values, everything gets trickier when the decision-making process is translated from the user to the machine.

Concerning another side of ethics, people usually object to robots they are emotionless. Only recent examples like Pepper robot⁴⁶⁸ include some "emotions". They claim that Pepper is capable to adapt to the mood of the users. Current Person Carrier Robots are not expected to be kind nor to have emotions. This might change if they include assistive capabilities. Person Carrier Robots, although being non-humanoid robots, might also be able to express artificial emotions in a meaningful way to humans independently of the general perception of what an emotion is⁴⁶⁹.

⁴⁶⁵ Sharkey, A. and Sharkey, N. (2010) Granny and the Robots: Ethical Issues in Robotic Care for the Elderly. *Ethics and Inf Technol*, pp. 27-40.

⁴⁶⁶ Dang, T. and Tapus A, (2015) Stress Game: The Role of Motivational Robotic Assistance in Reducing User's Task Stress, *Int J of Soc Robotics* 7:227-240

⁴⁶⁷ Promoted by the European parliament recommendations op. cit. and the British standard 8611:2016.

⁴⁶⁸

⁴⁶⁹ Novikova J K and Watts L (2015) Towards Artificial Emotions to Assist Social Coordination in HRI, *Int J of Soc Robotics* 7:77-88.



Figure 30 Robot Ranger from EPFL, source: chili.epfl.ch/page-105174-en.html

Ranger is a robotic box used to motivate children to tidy up their toys, a robot introduced in several conferences⁴⁷⁰ and also in the summer school in Lausanne, Switzerland in 2014. In any case, caregivers from disability organizations do not envision social assistive robots suitable for social interaction like giving the gentle touch of a hand, the warmth of a hug and the understanding of a conflict⁴⁷¹. So maybe these aspects should be modeled in a way that can accommodate the specificities of person carriers.

4.8. Justice

This part includes an interesting interview with Andrea Sundaram during summer 2016. Andrea is a Ph.D. student at the Human Engineering Research Laboratories (HERL) at the University of Pittsburgh⁴⁷². He invited me to visit HERL to see the different projects they are conducting⁴⁷³. Andrea studies assistive devices and he is also a user of them. Andrea was behind a project that incorporated the virtual seating coach in a manual wheelchair (MVSC) for repositioning matters to prevent pressure sores and ulcers. This was the first time it was incorporated in manual wheelchairs (there were normally incorporated in motorized wheelchairs only)⁴⁷⁴. He is a wheelchair user. He uses a motorized wheelchair that incorporates the feature of repositioning. Although he is not using a “wheeled passenger carrier” in the sense of ISO 13482:2014, his comments were very insightful so as to understand the vision of a user of robotic technologies. Just a quick comment on this: when I asked what was the category of a

⁴⁷⁰ J. Fink, (2012). How Children Tidy up Their Room with "Ranger" the Robotic Box. Poster at the 2nd site-visit of the NCCR robotics, ETH Zürich, Zurich, Switzerland, October 24-26, 2012. J. Fink, et al. (2013). Motivating Children to Tidy up their Toys with a Robotic Box. Presentation and Poster at the 8th ACM/IEEE International Conference on Human-Robot Interaction (HRI) 2013, Pioneers Workshop, Tokyo, Japan. J. Fink, S. et al. (2014) Which Robot Behavior Can Motivate Children to Tidy up Their Toys? Design and Evaluation of "Ranger". 9th ACM/IEEE International Conference on Human-Robot Interaction (HRI) Bielefeld, Germany.

⁴⁷¹ Wolbring G. et al (2014) Social Robots: Views of Staff of a Disability Service Organization, *Int J of Soc Robotics* 6:457–468.

⁴⁷² See more information about him here: www.herl.pitt.edu/person/andrea-sundaram

⁴⁷³ Visit www.herl.pitt.edu

⁴⁷⁴ This project even won a price. See more information at blog.innovation.pitt.edu/blog/herl-first-gear

robotic wheelchair that incorporated a robotic arm, HERL did not know what to answer.

We focused our conversation on the repositioning function because when I first met him he started going backwards and thought he was about to fall. He said that not all the wheelchairs had it, that he was very lucky because in fact the impossibility to move for wheelchair users from the sitting position could cause several problems to them. I thought that the incorporation of different functions that could benefit any wheelchair user (because it is to prevent the long-sitting problems) was connected with the idea of access to this technology. Not everyone could ever benefit from having robotic wheelchairs or, in this case, person carriers, even if there would be studies stating how good they can be for society. And this is a challenge to the avoidance of discrimination: those who have the money to pay a person carrier, or to pay a nursing home that incorporates this technology will benefit from them. If in Guatemala people struggle to pay a 25\$-medicine, it is unlikely that they could afford a person carrier⁴⁷⁵.

Then I realized that Andrea had to be carried around by another person. His joystick was, in fact, behind the back of his wheelchair. He said that he was visually impaired too, so that although he could move around the household and other places, he had to have a caregiver to take care of him. Connected with that, although HERL is a research center prepared for wheelchair users, it is also true that there are many doors, and corridors. Andrea argued that in fact the user was not really taken into account in the designing process of wheelchairs, especially in the interfaces. Interfaces are normally produced without a survey on which interfaces would suit better certain impaired persons. In fact, in the tour we did, the head of the department argued that users using a smartphone would use the wheelchair more and will do better the exercises⁴⁷⁶.

Another problem with carrier users is that they do not do the exercises that the physicians tell them. This reminded of the idea of the life-cycle nature of these technologies. Some times regulations are just concerned on the actual government of the technology ex novo but the ways the users can actually get the expected benefit from them is often neglected. Up to now, there has not been many reliable data on the actual benefit of these technologies, and that is what part of the community has doubts on the usefulness of such technology^{477,478}.

Andrea said: “A caregiver can help from the distance”. There are wheelchairs in their center that could be teleoperated by caregivers in a moment of need or help. My question was: But what do you do when the user needs something at night? One of the possibilities, he argued, was to create a call center with different caregivers that could help remotely control the arms of the users. However, it did not seem to me a very convincing solution as it would considerably increase the costs. Furthermore, call centers are at risk of being automatized⁴⁷⁹.

⁴⁷⁵ See the project livingonone.org. In fact, after seeing this project we had the thought on what was the effort that from the robotics community was being done to help others. We will talk about this more in the last part of chapter 5.

⁴⁷⁶ The exact sentence was “People don't do the exercises that they are been told. With an iPhone it would be easier”

⁴⁷⁷ Borenstein, J. and Arkin, R. (2016). Robotic Nudges: The Ethics of Engineering a More Socially Just Human Being. *Science and engineering ethics*, 22(1), 31-46

⁴⁷⁸ See the presentation of Dr. Lina Sors Emilsson at the workshop we organized in Almere, the Netherlands, on the legal and ethical aspects of social robots in therapy and education. See legalrobotics.files.wordpress.com/2015/11/lse_almere-okt-2015.pdf

⁴⁷⁹ In 2016, one company in the Philippines is deciding whether to transform its call center to a robotic center one. See www.wsj.com/articles/robots-on-track-to-bump-humans-from-call-center-jobs-1466501401. See also the predictions done by the Economist at www.economist.com/news/international/21690041-call-centres-have-created-millions-good-jobs-emerging-world-technology-threatens

Finally, whether we call them “wheeled passenger carriers” or “robotic wheelchair”, all these assistive technologies would have to be thought really through. Creators should in fact take into account many aspects when developing a device, from physical to cognitive aspects to the cognitive ones. Even if physical assistant robots seem to be more advanced and going to the personalization of the devices, we are not yet at this point with person carriers: not with segways (still not) nor with multiple-passenger carriers. Depending on the device, of course, access criteria will be assessed differently.

5. Summary of person carrier robots analysis

All the above-mentioned risks and solutions can be grouped and presented in a more practical chart. This chart can be useful to roboticists to understand long juridical discussions; and also to jurists to understand and translate into technical terms some legal requirements.

task-oriented
user-oriented
social interaction

CONTEXT	
Risks	Recommendations
Place	Specific requirements for different types of public/private institutions
	Specific requirement for the type of architecture/environment: cloud, IoT.
Users	Specific requirements: special attention to elderly, children and disabled people
Robot	CRIA should be developed for each robot the institution has
	Different safeguards depending on the technology applied to it, the robot's capabilities and the HRI
	Clarity on the type of robot and the regulation that applies to it
	Transformation of robots: addressing different categories in one robot
CRIA	Identify the internal/external stakeholders

SAFETY	
Risks	Recommendations
Navigation	The robot should have a map of the institution for navigation purposes
	It is important to identify tricky information, e.g. glass walls.
	Mapping and remapping indoor and outdoor environment from time to time so as to avoid any changes in the environment
	Sensor coverage: internal/external to the robot

	In lack of sensor information, electromagnetic tapes on corridors could be of great help for navigation purposes
	In buildings of new construction, the infrastructure of the building should be truly adaptable to the size of the devices to be inserted: corridors, doors and elevators should not be a constraint.
	If possible, the inclusion of robot-exclusive corridors and elevators could help avoid third parties problems. If not, the sharing of space between robot users and non-robot users should be carefully taken into account.
	If the carrier is going to be used outdoors, a GPS system for outdoor contexts, including relevant information about the environment (e.g. localization of trees, rubbish bins, traffic lights, etc.) could be of help. The use of an Automated Transport and Retrieval System could help too.
	The security of the carrier's navigation can be improved by intertwining inputs from the user, and the environment. Sensor coordination could lighten the weight of the carrier.
	Periter monitoring sensors could give a wider perspective to the robot.
	When including an obstacle collision warning sign, it needs to be taken into account the different target users. A vibration signal could help avoiding further problems with other impairments as sound or visual signs may have (deaf/blind people).
	Navigation pattern systems could be included to improve safety. Although this might challenge data protection, on the contrary, certain users could benefit from this: the detection of an anomalous behavior could lead to a protective stop.
	If not protective stop, a safety-related speed control if the device detects strange navigation patterns in the shared-mode could also be considered.
	Outdoor contexts should be avoided if the carrier is not prepared to do so.
	If used in outdoor contexts, compliance with traffic rules is mandatory.
	Consider the possibility you real-time navigation systems like the ones used for unmanned aerial vehicles
	If the carrier depends on Wi-Fi connection or other connections, loss of connection leads to protective stop
	Using deep map technologies could help improve navigation
	Using pre-built smart maps could help speeding the process of navigation planning and avoidance collision.
Collisions	High-precision sensory information is required
	Fast reaction times for moving obstacle avoidance is crucial
	It is important to increase user legibility so that third users can understand what is the carrier doing
	Collision avoidance systems should be mandatory.

	A horn or a sounding device as well as some lights to warn third users could be of use to avoid collisions
	After the device comes to a protective stop, or it collides with someone or something, the user should be capable of communicating with a person that could help him/her to go back to the institution, go to the hospital, etc.
	Impact absorbing surfaces and mechanics could be used to guarantee human physical safety
	Any roboticist should be working towards perfecting the autonomous mode and establishing supportive systems for the shared autonomous mode. Providing guidelines to other roboticists should be mandatory
Tipping over	Systems that provide smoothness of the action when the terrain is not smooth should be included, especially in outdoor contexts.
	Stability control should be implemented
	Sensors to detect architectonic barriers such as holes, stairs, etc. should be a fundamental part of the carrier.
	If the carrier tips over, there should be an autonomous communication capability with Healthcare system / Ambulance independent of the user.
Maneuvering	There should be an effort to reduce the bulkiness of the carrier
	A 360 Degree rotation could improve maneuvering
Non-Mission Task	For the non-mission tasks, behavioral analysis could help deciding what to do.
	Hierarchical Controller to could help evaluating the decision
	Real-time navigation system could help face this situation
	Environmental sensing could be of help
	External semantic support could be provided. If the support is given from humans, especial safeguards should be provided (to avoid hazards concerning the time delay); and the same happens if robots are the ones to provide support.
HRI	For the physical HRI, there should be compliance with specific technical instruments such as ISO 13482:2014
	The cognitive aspects need to be taken into account. For instance, addressing the feel of pain or discomfort of the user, or the feeling of hopeless after a protective stop.
	Perceived safety is of major importance, so roboticists will have to make sure that the users feel safe when using their device.
Sensor Invasiveness	As a general rule, used sensors need to maximize the richness of information while minimizing the invasiveness of the required instrumentation
	Electromyography is preferred in BCI
	Environmental sensing could be preferred rather than invasive techniques
Stair-Climbing function	Smoothness of the action is mandatory.
	Horizontal position of the wheelchair is preferred

Specific capabilities	If the wheelchair has any special feature, it will need to be addressed in order to see what safeguards and protective measures need to apply
Mode Transition	Heuristic rule-based classifiers can provide safety in mode transitions
	Avoid certain functions in certain modes, e.g. avoid climb function if mode bed is on. The roboticist should provide protection in both moments: during the state and during the transition between states
Weather conditions	incorporate all-terrain features, especially if the device is going to be outdoors
Hacking attacks	Incorporation of a protective stop after the system is hacked
	Protect the user from any harm after the carrier is hacked
	There should be an autonomous notification to the competent authority of the hacking it could be (Data Protection Authority or European Robot Agency if ever created)
	Secure wide area communication
Others	Consider incorporating house indicators which are self-actuated when the device enters a turn
	Coordination between devices when there are more devices than charging points
	If the institution is big enough, ensure that there are available fully charged carriers for the night, and that the rest are charging in valley moments
	Incorporate sensors and communication capabilities to the elevators if more than one floor
	Smart power management for maximal energetic efficiency
	Incorporate seatbelt to offer a maximum level of protection
USER PROTECTION	
Risks	Recommendations
Robot Categories confusion	The roboticists should place the appropriate definition of his/her device and its capabilities to avoid further confusion to users but also to authorities.
	The compliance needs to be done according to the capabilities of it, which may imply compliance with different regulations.
	Special attention to Medical Device Regulation for "wheeled passenger carrier".
	Different standards will have to be applied for transforming/mixing categories, e.g. a carrier that transforms into a mobile servant.
	The authorities should be working on avoiding over-/under-regulated scenarios
	A dynamic personalized regulatory model for each specific robot could be placed
	The granted certification should go in line with the product not with the intentions of the creators

	The roboticist needs to be sure that the certification agency has conducted the appropriate checks because if someone responsible will be the creator, not the agency
Consumer robotics	The categorization of the robot should not lead to deception.
	Roboticists need to be conscious of the use of green technology: electric motors, acceptable audible warnings and green materials for the creation of the device (kenaf-fibre bioplastic in its softer panels and Acrylic resin panels to offer more strength)
	Exploration of new materials with different physical properties (mechanical, electrical, ¹¹ SEP, etc.) could be of help to go green.
	Protection of the Health of Users is of primordial importance.
	For hygienic reasons, devices need to be cleaned and disinfected, if necessary, by a specialized company
	Both certified and perceived safety are important.
	The user interface should be user friendly, easy to use and user-centered.
	The interface should incorporate the vocabulary according to the context of use and also be impairment adaptable.
	The user needs to be correctly informed about the carrier capabilities
	Driving Tests should be placed in case of need.
	Addressing Cosmesis is very important for the self-esteem of the users
Contract Law	General Contract condition: Avoidance of abusive clauses
LIABILITY	
Risks	Recommendations
Before harm occurs	There is the need to create a Living lab or an Empirical Testing Zone for regulatory purposes that can test person carriers and its transformations
	It is crucial to embed by-Design Principles (using programming language incorporating privacy by design, for instance).
	There should be compliance with main safety certifications
	Roboticists need to be sure that ethical design certifications apply or not to their case, and follow them too.
	If the European Robot Agency is ever created, there should be the obligation to register the device with the specifications.
After harm occurs	The roboticist will need to argue that he/she did all the best to apply the available knowledge to the device (Development risk defense: Art. 7.e of Directive 85/374/EC)
	Black boxes could help identify the problem. If used, it will need to be clear who has access to them and also whether it is going to be valid in Court.
	Creation of European Robot Agency (accountability and enhancing liability)
Autonomy	Solve division of responsibility on the autonomous behavior of the robot

	Insurance: determine whether the robot needs self-/ mandatory insurance or just a complementary insurance
USER RIGHTS	
Data Protection	The third uses of the collected data should be prevented if there is no consent for that. Attention should be done to the general clauses for the consent to not be abusive.
	The lack of awareness of the collected data should be avoided. There should be placed transparency, especially with elderly and impaired people
	If the robot is personalized, protection against vandalism acts should be offered. The inclusion of a password or bionic identification could help at this regard.
	It is fundamental to state the clear purpose of the data usage.
	Roboticians need to understand how informed consent works and collect it before using their device.
	There should be an effort to assure that the consent is actually informed.
	A dynamic consent schema could be considered to ensure consent over time.
	If there are profile modules, the right to portability needs to be guaranteed
	A cloud platform could help manage all the information collected from the sensors. Data protection issues need to be addressed in this environment. Encrypting the tunnel between robot and cloud could protect data-in-motion and the use of a private cloud without neighbors could promote an added safeguard at this regard.
	The user should be the owner of the data and should be the one that clearly and easily can cancel the data. Assurance that this procedure is placed is a must.
	If the environment is Internet-of-Things, more precaution should be placed on the massive collection of data.
	Right to be forgotten should be a reality and should be placed by default.
Privacy	Proxemics should be studied in scenarios with third users.
AUTONOMY	
Risks	Recommendations
Robot's perspective	For the autonomous mode, there should be implemented a detailed Control Strategy, the limits of the workspace should be defined, and a clear definition of the autonomous task should be defined. In autonomous mode, it is crucial to set which are the forbidden areas.
	In shared mode, a driving test could improve efficiency of the task and provide more safety
	It is important to know when the device works on autonomous, in shared, or in other modes. Level of autonomy should be clearly defined.

	Shared control percentages could also be reviewed in the case of vulnerable parts of the society, e.g. leaving less room for human decision when elderly drive them
	Compensation rules should be modeled and personalized for the user.
	The use of machine learning techniques could help improve the efficiency of the task. Attention to the data protection is required.
	In case of doubt, the autonomous mode should mandatorily come to a protective stop
	A human supervision should be preferred among automative decision-support systems, but future seems inevitably going to the autonomous version. This will have to be especially considered
User's perspective	From the user's perspective, it should be promoted his autonomy
	The user should be involved in the decision-making process of the machine, even if it is in autonomous mode, e.g. asking permission to go to certain destinations
	It will need to be decided in which cases the autonomy of the user prevails in front of the one from the carrier.
	There should be respect and validation of the user's decisions.
	Balance between user's safety and user's decision-making
	Inclusion of Automated Transport and Retrieval System for supervised autonomy to provide safety margin when the system is uncertain on how to proceed before a non-mission task
	The system should promote the user's independence without causing a dependence beyond what is considered normal for carriers
DIGNITY	
Risks	Recommendations
Isolation	The bulkiness of the carrier cannot provoke an isolation scenario
	The device should be made transportable and integrated
Substitution of Human Workers	The technology should not be created to replace human workers, but to help them performing their tasks better.
	In the case technology subsitutes workers, a replacement plan for these workers should be draft
Decrease of human touch	It is crucial that robots promote Human-Human Interaction.
ETHICS	
Risks	Recommendations
Autonomy	In the case the carrier needs to stop, it will only do so if it is less dangerous than continuing performing the task.
Free will	Elderly should make decisions about their welfare
	The system will need to decide whether it prevails the free will of the user (in case of a suicidal request) or his/her safety.
Impaired patients	Balance between interests

Moral Judgements	If there are any moral judgements, empathy should be modeled to help deciding the device
	Moral Expectation and principle of double effect should be taken into account
	The respect for social norms is crucial
User-Centered	Include a user-centered design to cope with real needs of the users
	Include reposition function
	Design the Institution in a way that these devices can be accommodated with less impact on users and workers
JUSTICE	
Access	Low-cost technology to enhance equal access
	Aids and grants for those in need

Table 5 Possible list of engineering controls for wheeled passenger carriers (sub-type person carriers)

PART B: Physical Assistants

Accept the proposition that humans are not disabled. A person can never be broken. Our built environment, our technologies are broken and disabled. We the people need not accept our limitations, but can transcend disability through technological innovation. Hugh Herr.

1. Physical Assistant Robots: lower-limb exoskeletons

This section will be about restraint-type physical assistant robots (*see* Fig. 1). Physical Assistant Robots (PAR) are non-social assistive robots and a sub-type of personal care⁴⁸⁰. They assist users to perform tasks by providing an augmentation of personal capabilities⁴⁸¹. PAR have been used for lower limb rehabilitation⁴⁸², for gait rehabilitation of stroke patients⁴⁸³, to help mobility of handicapped or elderly people with functional disorder in their legs⁴⁸⁴, or even as an assistive device for home oxygen therapy⁴⁸⁵. They are good helpers for elderly unable to sit, stand or who need personal assistance at home but they cannot afford human care givers⁴⁸⁶. Essentially, they are robotic devices that help users to walk. Walking is a primary function, it stabilizes blood pressure, improves pulmonary ventilation, prevents the degeneration of muscle and bone tissue and increases joint mobility⁴⁸⁷.

⁴⁸⁰ M. Heerink, Assessing Acceptance of Assistive Social Robots by Aging Adults, Thesis completed, University of Amsterdam, Netherlands, 2010, pp. 9–22, 41–51, 87–99.

⁴⁸¹ ISO 13482:2014 “Robots and Robotics Devices – Safety Requirements for Personal Care Robots”.

⁴⁸² Q. Zhang, M. Chen, L. Xu. Kinematics and Dynamics Modeling for Lower Limbs Rehabilitation Robot. ICSR 2012, LNAI 7621, pp. 641-649 (2012)

⁴⁸³ K. Yamaki et al. Application of Robot Suit HAL to Gait Rehabilitation of Stroke Patients: A Case Study. ICCHP 2012, Part II, LNCS 7383, pp. 184-187 (2012)

⁴⁸⁴ M. Nozawa, Y. Sankai. Control Method of Walking Speed and Step Length for Hybrid Assistive Leg. ICCHP 2012, LNCS 2398, pp. 220-227 (2002)

⁴⁸⁵ G. Endo et al. Mobile Follower Robot as an Assistive Device for Home Oxygen Therapy – Evaluation of Tether Control Algorithms. ROBOMECH Journal, 2:6 (2015)

⁴⁸⁶ *See* Rupala, B.S., Singla A. and Virk, S. (2016). Lower Limb Exoskeletons: A Brief Review. Available at: www.researchgate.net/publication/296396096_Lower_Limb_Exoskeletons_A_Brief_Review

⁴⁸⁷ Extracted from: <http://www.exomed.org>

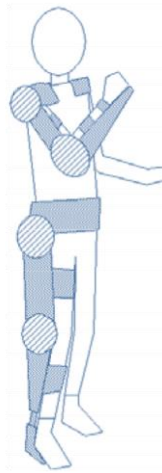

Figure 31 Exoskeleton Wearable Robot as showed in ISO 13482:2014.

An exoskeleton is the opposite of an endoskeleton, that is, a rigid external skeleton that covers for the body in some invertebrate animals. From the Greek *ἔξω* that means “outer/external” and *σκελετός* that means “dried body” alias skeleton. When relating to robotic technology an exoskeleton is basically “wearable robot attached to the wearer’s limbs in order to replace or enhance their movements”⁴⁸⁸. Their Human-Robot Interaction (HRI) is very high. In fact, people depend on them to execute some intended tasks. Among the different types of physical assistant robots – e.g. body weight supportive device, exoskeleton wearable robot, wearable robot or restraint-free assistance robot – we will focus on exoskeletons.

In 2014, at the International Workshop on Medical and Service Robots (MESROB) in Lausanne I had my first experience with exoskeletons. Some Brazilian researchers presented their research on a Brain-Computer Interface (BCI) Exoskeleton. A user of the exoskeleton was meant to give the first kick of the world cup football. And he did. Prof. Dr. Mohamed Bouri is the Group Leader of the Laboratoire de Systèmes Robotiques (LSRO), from École Polytechnique Fédérale de Lausanne (EPFL) in Lausanne, Switzerland. His research group was working on lower-limb rehabilitation exoskeletons.

After getting to know AGV and robotic wheelchairs, I realized that although ISO 13482:2014 put person carriers, physical assistant robots (exoskeletons) and mobile servant robots all together, they were very different. The Robolaw project addressed exoskeletons together with robotic prostheses in its chapter 4 instead of including them in its chapter 5 about “care robots”; even if ISO 13482:2014 does not talk about prosthetics. They make the difference between prostheses and “active orthosis” or exoskeletons: “while prosthesis implies the replacement of a body part or an organ which is physically missing (such as in a limb amputee), an exoskeleton or an active orthosis are meant to improve the functionality of a body part, which is still existing, although it has reduced or no functionalities left. In other words, an exoskeleton or an orthosis are not meant to physically replace a body part, but to replicate or enhance its function”. Although there is a thorough legal and ethical analysis on the use of

⁴⁸⁸ ibidem.

prosthetics, there is no such deep analysis for actuated orthosis under the RoboLaw project. That is why we wanted to dig in it.

Prostheses are implantable devices that are considered medical devices⁴⁸⁹. If used in rehabilitation, actuated orthotic devices (among others, exoskeletons) are going to be also considered medical devices. The FDA defines powered exoskeleton as “a prescription device that is composed of an external, powered, motorized orthosis used for medical purposes that is placed over a person's paralyzed or weakened limbs for the purpose of providing ambulation.”⁴⁹⁰. ISO 13485:2013 – in line with the Council Directive 93/42/EEC of 14 June 1993 concerning medical devices – defines medical devices as “any instrument [...] to be used, alone or in combination, for human beings for one or more of the specific purpose(s) of: diagnosis, prevention, monitoring, treatment or alleviation of disease [...]”. If the aim of the exoskeleton is to enhance patients' sanity, their intended use is rehabilitative, the medical devices' regulation should apply (FDA regulation for the U.S.).

It is very interesting that ISO 13482:2014 focuses on robots and robotic devices for activities of the daily living (ADL), thus “excluding medical applications”. These activities of the daily living can include a variety of scenarios, such as warfare scenarios (to carry heavy combat loads, like the HULC exoskeleton⁴⁹¹), production scenarios (to help the workers lift and carry heavy boxes and materials, like the Panasonic suit⁴⁹²), or simply daily living scenarios (to improve user's physical activity, like in the EXO-LEGS project⁴⁹³) (see Fig. 2). Gurvinder Virk, Chairman of the ISO TC 184/ SC 2/WG 7 on Safety of Personal Care Robots, supports the idea that “if the robot improves the production of the factory, then it is considered an industrial robot; if, on the contrary, it helps improve the user's quality of life, then it is a personal care robot”. If the context is not rehabilitation, then the personal care robot standard is the one that should govern this technology.

⁴⁸⁹ This is recognized by the American Food and Drug Administration (FDA) (see <http://www.fda.gov/MedicalDevices/ProductsandMedicalProcedures/ImplantsandProsthetics/>) and for the European Commission (see the classification made in this guidance document on medical devices http://ec.europa.eu/consumers/sectors/medical-devices/files/meddev/2_4_1_rev_9_classification_en.pdf).

⁴⁹⁰ See <http://www.accessdata.fda.gov/scripts/cdrh/cfdocs/cfPCD/classification.cfm?ID=PHL>

⁴⁹¹ See HULC, an exoskeleton in Berkeley Robotics and Human Engineering laboratory. Available at: <http://bleex.me.berkeley.edu/research/exoskeleton/hulc/>. See also:

<http://www.lockheedmartin.com/content/dam/lockheed/data/mfc/pc/hulc/mfc-hulc-pc-01.pdf>.

⁴⁹² See <http://news.panasonic.com/global/stories/2016/44969.html>

⁴⁹³ See the project Exo Legs run by Prof. Dr. Gurvinder Virk and others: <http://www.exo-legs.org/about.html>



Figure 32 Different Exoskeletons: HULC, Panasonic and Exo-Legs⁴⁹⁴

A brief comment on the use of exoskeletons for military purposes. The scope of ISO 13482:2014 consists in addressing safety requirements for personal care robots. These robots have a precise and well-defined goal, that is, to improve the life of the intended users. They are referred to as “service robots” because they perform tasks for the sake of human care. Conversely, military robots are expressly out of this scope. Reality seems anyway to intertwine personal care robots with a military context (as in the example of the industry). HULC is an exoskeleton intended to work in warfare environments. This exoskeleton gives supplementation of force and increases ability, strength and endurance. However, there is no specific guidelines on the precise use of exoskeletons, whether they can incorporate gunfire or other weapons. The use of them in this context raises some ethical questions⁴⁹⁵. In this section we will talk about physical assistant robots for the ADL.

The project EXO-LEGS is an example of exoskeleton for these activities and it can be used for elderly people with no pathological condition who want to increase their level of physical activity. The objective of the project is to develop a lower body mobility exoskeleton to help people move around to perform normal daily tasks. For them, motion tasks include standing up, sitting down, straight walking on flat ground,

⁴⁹⁴ HULC op. cit.; Panasonic op. cit.; Exo-Legs see www.cartagenadehoy.com/index.php?option=com_content&view=article&id=55599:el-exoesqueleto-se-probara-este-otono-en-la-region-de-murcia&catid=101:cartagena-de-hoy

⁴⁹⁵ If interested in the militarization of police (precisely for SWAT teams which were originally devised for emergency situations and that now they are being used in many other occasions) see Glantz, A. (2009). *The war comes home: Washington's battle against America's veterans*. Univ of California Press.

stepping over objects, walking on soft and uneven ground and walking up and down stairs⁴⁹⁶.

Interestingly, this project wants to create basic, standard and deluxe versions of the device with different technology and capabilities. This kind of technology can be of high relevance and importance for the present analysis for various reasons: 1) different categories could help facilitate the access to this technology; 2) different technology applied to the robots would entail a much more diverse legal complexity.

Law is always some steps behind reality: although some PAR are already present in healthcare institutions (like Ekso Bionics or ReWalk), there are no laws addressing their use and appropriate management, no judge is specifically trained to deal with such new technologies, and end-users (mainly patients) are of course more concerned with their condition than with legal aspects related to these robots. In this regard, although European Parliament sent some recommendations on the regulation of robotics to the European Commission in May 2016, this type of technology does not appear in their recommendations⁴⁹⁷. Public policy has been focusing lately on drones and autonomous driving cars, but this specific technology, as well as the rest of personal care robots, has not been addressed yet.

The main objective of this chapter therefore is to identify legal and ethical aspects concerning physical assistant robots with a special attention to lower body mobility exoskeletons, and to see the differences between them and their non-social counterparts, i.e. person carriers.

2. Context

Several clinics and nursing homes have decided to use the newest robotic technologies to rehabilitate their patients. The MossRehab in Pennsylvania for instance⁴⁹⁸ offers the possibility to do physical rehabilitation with Lokomat from Hocoma to patients that have suffered stroke, brain or spinal cord injuries⁴⁹⁹. EksoBionics has even a website where you can find institutions using exoskeletons to do rehabilitation⁵⁰⁰. Currently, there are not many institutions that offer this type of technology for training purposes, i.e. not for rehabilitation.

The upcoming Medical Device Regulation of 2017 may blur the medical/non-medical distinction that ISO 13482:2014 did through its art. 1.3, which states that devices with both a medical and a non-medical intended purpose shall fulfill cumulatively the requirements applicable to devices with an intended medical purpose and those applicable to devices without an intended medical purpose⁵⁰¹. This means that the context of use may not matter that much because the risks they present (by birth, so as to say) are the same independently of the context of use, in this case rehabilitation or activities of the daily living.

⁴⁹⁶ Not all the exoskeletons introduce the stair-climbing function. For instance ReWalk does not have it. Read "what is Rewalk" in <http://rewalk.com/faqs/>

⁴⁹⁷ See 2015/2103(INL) European Parliament Resolution on Civil Law Rules on Robotics (May, 2016), p. 16.

⁴⁹⁸ Visit <http://www.mossrehab.com>

⁴⁹⁹ See www.mossrehab.com/robotics/lokomat but also the company Hocoma <https://www.hocoma.com/usa/us/products/lokomat/>

⁵⁰⁰ See <http://eksobionics.com/centers/>

⁵⁰¹ Medical Device Reform, see chapter 1 and data.consilium.europa.eu/doc/document/ST-10728-2016-REV-4/en/pdf

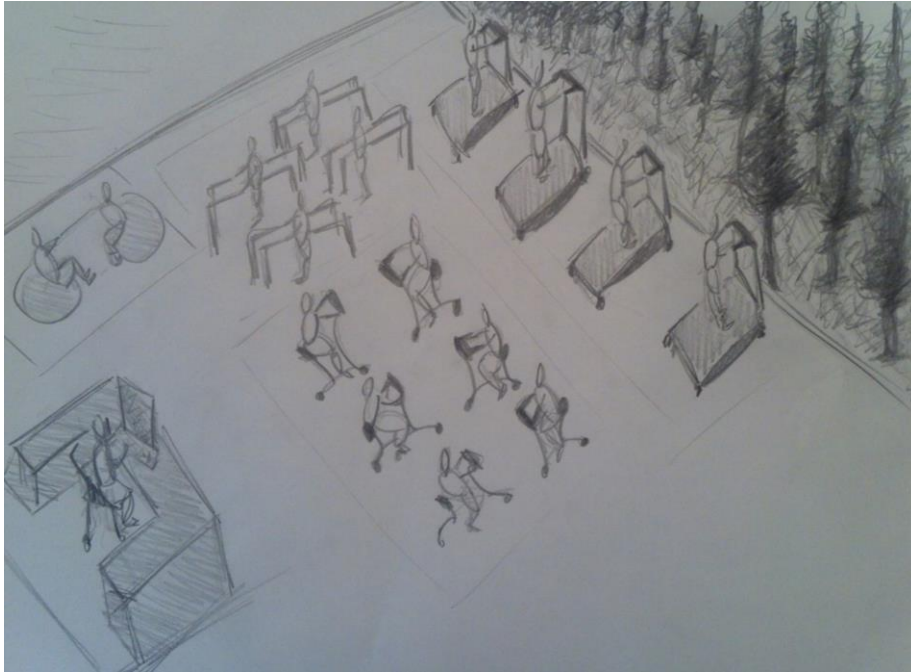

Figure 33 Envisioning Robogym. Sketch Vite-fait from Helena Heras.

In any case, the context for this section is a gym for people who want to improve their physical condition with exoskeletons. Up to now, such a kind of gym does not exist in reality, but hopefully it will be available in the near future to help patients⁵⁰²:

«RoboGym has opened its doors! RoboGym is the first gym for elderly that uses the newest robotic technologies. RoboGym offers several facilities designed to improve and maintain physical wellness. Go to the ExoKlass and try the newest exoskeletons that will help you exercise and improve muscle activity. Go and try RoYoga with our new little humanoid robot that will bring about peace of mind⁵⁰³. You may also want to use the swimming pool to do aquatic therapy with the octopus robot to feel renewed⁵⁰⁴. At RoboGym we are Bring-Your-Own-Device (BYOD) friendly: if you happen to have already an exoskeleton, bring it to the gym to

⁵⁰² This scenario is based on current existing trends and future projects that cannot be revealed at the moment of writing but that in the future it will be a fact. This is very different from the initiative that Elon Musk is pursuing at <http://www.natureworldnews.com/articles/21579/20160504/elon-musk-opens-robot-gym-for-artificial-intelligence-training.htm>. Some “robotic gym” was mentioned in Krebs, H. I., et al. (2008). A paradigm shift for rehabilitation robotics. *IEEE Engineering in Medicine and Biology Magazine*, 27(4), 61-70; but this scenario refers precisely to the creation of a gym for elderly persons to train with robots with no especial rehabilitation behind it.

⁵⁰³ Inspired by this piece of news <http://www.digitaltrends.com/cool-tech/alpha-2-robot-crowdfunding-news/>

⁵⁰⁴ A lot of research has been conducted in comparing the use of a robotic body-weight system that provides assistance in walking through robotic technology and aquatic-based exercises providing support, *see* <http://umrehabortho.org/research/ct/lokomat-aquatic-therapy>. We think that in the future it will not be strange to find that robotics have found the way to combine robotic technology and therapy, like using the octopus Kraken, *op. cit.*

learn more about exercises and training circuits. Be part of the Active Aging Society and don't miss the opportunity. Register now and you will get 50% off in your first month bill!»

A gym is a structured environment that includes programmed daily routines. Facilities are structured: there are 2 elevators, stairs, one locker room for women, one for men, several rooms, a swimming pool of 25x10 meters and one basketball court. At this moment there are 345 registered users, some are overweight and some are very tall. The schedules change every six months but normally the timetables and courses are basically the same (*see* Fig. 3). There are 4 rooms for the different courses: one to work with exoskeletons, and the other one for the yoga course. The other rooms are free to use by users that want to practice with the devices without having to attend a course. As the exoskeletons' battery does not last very long, there are only two scheduled classes a day (so that they can be recharged).

Gym	Users	Performance
1 main building, two floors	345 registered	2 classes/day with ExoKools
2 elevators	250 active	1 class/day with Octopus
4 exercise rooms	Average age: 65	3 classes/day with RoYoga
1 swimming pool	27 overweight users	
1 basketball court	40 users over 185cm	

Table 6 Summary of the different facilities, users and courses at RoboGym.

The particularity of the gym is that the users can bring their own devices. There are many users that have bought exoskeletons but they do not know how to best use them. Some users want to use their own exoskeletons instead of sharing because most of them are personalized, which optimizes safety (*see* the ethics section). The gym offers also the possibility to download the preferences and already pre-configured settings on their devices through cloud robotics. Although it might sound futuristic, some researchers at Brown University, California University, and University of Darmstadt think that this is going to be possible⁵⁰⁵. This changes how safety will be understood and also how the allocation of responsibility will be established, as it will be very complicated to allocate responsibility to the scenario where the device belongs to the gym but uses settings and parameters of users.

We imagine that Robogym trainers have a fitness certification issued by large companies offering this type of certifications. However, they have not been specifically trained for using these devices. As in theory they are not rehabilitation practitioners, they had no more than a general safety course. They did several courses with the use of new technologies in fitness classes but they did not use precisely ExoKools, the

⁵⁰⁵ Although these researchers talk about other technologies, they are talking about the same concept. Yet, the use of cloud robotics and the adaptation of the knowledge acquired by one robot to another one that it is not exactly the same is not very reliable. Although many of the systems would be working on ROS language programming, the fact that these devices are physically different (their embodiment largely differs from one to another) makes it more complicated to be this yet a reality.

exoskeleton that we will address⁵⁰⁶. Seen that most of the personnel did not have previous knowledge on this kind of technologies, the gym has asked the companies selling their devices if they could offer also staff training (*see* liability section).

In this case, internal and external contexts will differ considerably, because the companies of each robot in the gym (exoskeleton, octopus or yoga robot) are different. In order to improve efficiency, they are different but they will be sharing the same network and they will be all connected to the server of the gym, which will monitor their use and their activities. A lot of data will have to be shared among different providers in order to make it possible (*see* user safeguards' section).

3. Robot type: Lower Body Mobility Exoskeleton “ExoKool”

This section introduces Exokool⁵⁰⁷. Although the field of exoskeletons is largely covered because there a lot of companies and research groups working on them, and despite the high amount of applications and designs, the number of devices per category is relatively low⁵⁰⁸. In fact, there are not that many companies working on exoskeletons for ADL, the majority of the companies focus on rehabilitation purposes. Exokool is therefore a fictitious prototype inspired by the work of different research projects: HiBSO at the LSRO, EPFL, Switzerland⁵⁰⁹, the EXO-LEGS project⁵¹⁰ and the ExoLite project⁵¹¹. One of the projects, the HiBSO project, focuses on assisting the hip flexion-extension of elderly; and the EXO-LEGS project focuses on creating a lower-limb exoskeletal assistive solution to improve the physical and cognitive condition of elderly⁵¹². As both are crutches-free devices, and they can be complementary to each other, we have decided to merge them (Fig 4).

⁵⁰⁶ This is part of the scenario. We want to highlight here that in the future this might no be the case because there will be companies issuing these certifications. At the moment of writing the thesis however it is not clear if a future institution similar to RoboGym should incorporate in their personnel some specialists and workers that are already familiar with this; or if it could be enough that the company itself trains the trainers.

⁵⁰⁷ We need to say in advance that we are not engineers and that although we have done our best in getting the precise knowledge to configure these sections from interviews, academic papers and visits to different companies and research centers, some of the information within the technical part will have to be double checked by engineers. The idea however was to continue the bottom-up methodology and explain to the legal community the importance to know what are the precise characteristics of the different robotic systems in order to conduct policies or regulations concerning to them. Particularities matter and then render different every single robot that will have to be analyzed in a case-by-case basis.

⁵⁰⁸ Baud. R. et al. (2016) HiBSO Hip Exoskeleton: Toward a Wearable and Autonomous Design. International Workshop on Medical and Service Robotics (MESROB) 2016 Workshop Proceedings. Available at: http://www.mesrob2016.at/images/uploads/Papers/MESROB2016_paper_15.pdf

⁵⁰⁹ See <http://lsro.epfl.ch/page-118584-en.html>

⁵¹⁰ Project under the Ambient Assisted Living. See <http://www.exo-legs.org>

⁵¹¹ This is a Russian Project from the Department of Mechanics, Mechatronics and Robotics of Southwest State University, Kursk, Russia. We had the possibility to meet the researchers at RAAD 2016 in Belgrade, Serbia; and MESROB 2016 in Graz, Austria. The idea of the researchers is to produce a low-cost See www.exomed.org

⁵¹² As the project states “Most elderly persons suffer mild to acute degrees of physical and cognitive degeneration. The progressive nature of these impairments often leads to loss of independence affecting quality of life. However, it has been shown that physical mobility and cardiovascular exercise directly improves human cognitive abilities, and can reduce biological and cognitive senescence³. Therefore this proposal will develop a range of active lower-limb exoskeletal assistive solutions (Basic, Standard and Deluxe) for providing indoor and outdoor mobility to help elderly persons maintain and improve levels of physical activity for full, active and independent lives”. See the idea at <http://www.exo-legs.org/about.html>



Figure 34 From left to right: Exo-Legs, HiBSO and ExoLite.

Wearable exoskeletons share some of the characteristics with “wearable technology”. Although wearable exoskeletons are not in miniature, they are body-borne computational and sensory devices that can collect a wide range of information from the user’s body and from the user’s environment. Wearable computers can be worn under, over or in clothing or may also be clothes themselves. Exoskeletons are normally worn over clothing. Although current exoskeletons might differ a bit from other wearables (as some examples glucose monitors⁵¹³, heart monitors⁵¹⁴ or sleep improvers⁵¹⁵), they “contextualize the computer in such a way that the human and computer are inextricably intertwined” in any case⁵¹⁶.

3.1. Description of the Robotic system and applications

Exokool is a wearable active assistive orthosis that is fastened to the body of the user, follows the user’s limbs on a symbiotic manner and participates actively to his/her movement (*see* Fig. 5).

⁵¹³ See more information at: pancreum.com/index.html.

⁵¹⁴ See more information at: www.preventivesolutions.com/technologies/body-guardian-heart.html

⁵¹⁵ See <https://kokoon.io>.

⁵¹⁶ Mann, S. (2012) Wearable Computing. In: Soegaard, M., & Dam, R. F. (2012). The Encyclopedia of Human-Computer Interaction. The Encyclopedia of Human- Computer Interaction. Available at: <https://www.interaction-design.org/literature/book/the-encyclopedia-of-human-computer-interaction-2nd-ed>

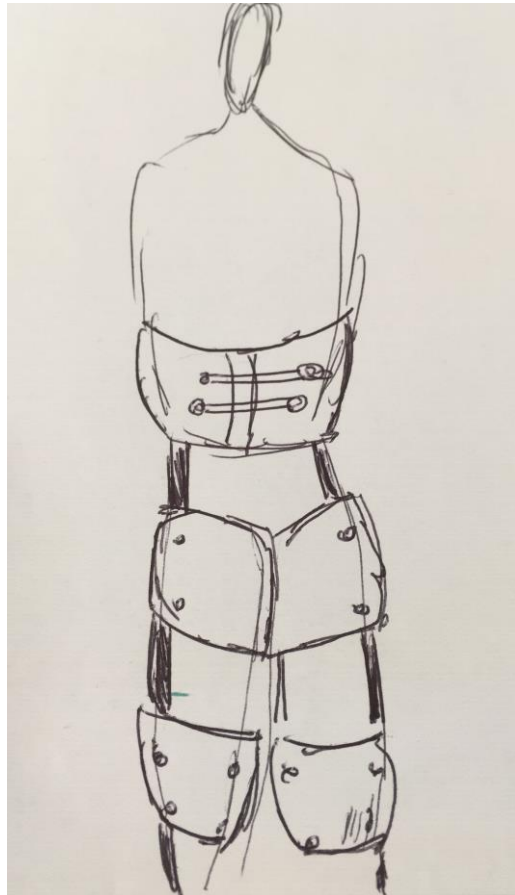

Figure 35 ExoKool design. *Vite-fait* own sketch.

Similar to the HiBSO, ExoLegs or ExoLite projects, ExoKool is going to provide indoor and outdoor mobility. Concerning outdoor mobility, a lower-limb mobility exoskeleton provides the possibility to walk and turn on uneven terrains, in unstructured surfaces. It helps the user avoid traffic, cross roads, take public transport easily, opening/closing doors, as well as using escalator. Regarding the indoor mobility, this type of exoskeletons can help the user go up and down stairs as well as to step over objects, perform stand-sit maneuvers, which could not be possible with a wheelchair due to its bulkiness. The system can also provide information to the user as well as advice to allow decision making when the elderly person gets lost or confused. Thus, similar to the EXO-LEGS project, ExoKool also provides cognitive support to the user.

Concerning the applications, these exoskeletons could be used in multiple situations. Here are some comments to be made⁵¹⁷. In theory, the usage of a robot should not determine the regulation under which it falls. On the contrary, a robot should be compliant by its inner and default capacities, not by its use; otherwise legal compliance

⁵¹⁷ This is part of the already published work we conducted for the Medical and Service Robot International Workshop (MESROB) 2015 in Nantes. Here is the reference: Villaronga, E. F. (2016). ISO 13482: 2014 and Its Confusing Categories. Building a Bridge Between Law and Robotics. In *New Trends in Medical and Service Robots* (pp. 31-44). Springer International Publishing.

could be at risk. Indeed, a robot may have some default capacities (communication capabilities, a data collection system, autonomous behavior, etc.) that could in fact cause different problems in legal terms, independently of how the robot is used and of the ISO certifications it may have obtained. Roboticists should thus be particularly careful: for instance, if a robot is not used as a medical device, that does not consequently mean that its by-default capacities do not need to comply with current laws.

From a legal perspective, if a robot does not involve any new scenario and existing laws already address every legal aspect associated with that robot, then there should be no need to create new laws. Indeed, if a personal care robot has some characteristics that are already well described and regulated in the medical device and personal care robot regulations, it will not be necessary to require additional or other legal compliances. Actually, it would be easier if some basic regulatory models for the by-default capacities existed; and then some regulatory complements were added depending on the specific situations or specific contexts and the new capacities involved. Unfortunately, such modular model does not exist yet, and exoskeletons are a non-previously existing technology which will have to be carefully addressed, as not only is fastened to the body but it also works on a symbiotic manner with the user.

3.2. Characteristics of the Robotic system and applications

ExoKools work independently and are not part of any robotic system. This makes them different from person carriers (which are normally part of an IoT environment, especially in outdoor context but also indoor so that the device can speak with the elevator, for instance) or mobile servants (which can be easily connected to different wearable technology and also ambient assisted living technologies).

The characteristics that normally are taken into account for the specification of the product vary among producers. Here we present a table with information about the different devices that inspire ExoKool, which include: the model, the size of the device⁵¹⁸, device model⁵¹⁹, device weight but also the body weight limit of the user, battery life, speed of the device, if it incorporates the stair-climbing function or not, if the device incorporates autonomy, the level of assistance provided to the user, and the presence of accessories (*see* Fig. 6):

⁵¹⁸ In HAL – Cyberdine there are a lot of specification concerning the different sizes of the device, but we only wanted to highlight the fact that they take into account different sizes. For the rest, the specification goes in line with the height of the person that will need to be compensated with the maximum weight permitted by the device.

⁵¹⁹ We wanted to include the different models that the different companies or research groups have because this will have a huge impact on the future discussion on the safety safeguards. In concrete, we will argue the fact that the safety for the user should not depend on the category chosen and, foremost, it should not depend on the quantity of money the user has spent because that could lead to an economic discriminatory scenario. At this regard, interesting the opinion of Marmot M. where he highlights the importance on the differentiation between ignorance and poor conditions, and between Gross National Product of countries, the income of the individuals and the income inequalities among regions. *See* Marmot, M. (2002). The influence of income on health: views of an epidemiologist. *Health affairs*, 21(2), 31-46.

Parameter	Physical Assistant Robots. Lower Limb Exoskeletons				
Model	HAL - Cyberdine	EXO-LEGS	HiBSO - EPFL	ExoLite - SWSU	ExoKool
Users	Elderly (non-Medical)	Elderly (non-Medical)	Elderly (non-Medical)	(non- Rehabilitation and Home Users	Elderly (non-Medical)
Device Seize	S/M/L	Doesn't say	Unique Size	People for height from 160 cm to 190 cm	People from 160cm to 190 cm
Device Model	Medical/Non-Medical	Basic-Standard-Deluxe	Doesn't say	Doesn't say	Basic-Standard-Deluxe
Device Weight	Double leg 12 kg / Single leg 7 kg (excluding the battery)	Doesn't say	14 Kg		15 Kg
Body Weight Limit	lower than 80 kg	Doesn't say	Doesn't say	lower than 80 kg	lower than 80 kg
Battery Life	60-90 minutes	Wear time: 30-60. Battery doesn't say	90 minutes	480 minutes	300 minutes
Speed	Doesn't say	Doesn't say	4 kmh	5 kmh	4.5 kmh
Stair-Climbing	Doesn't say	Yes	yes	yes	yes
Robot Autonomy	Yes	Yes	Yes	Yes	Yes
Assistance	Doesn't say	30% max. physical capacity	Assistance: not much	Doesn't say	60% max. physical capacity
Accessories	Belt for fastening, hip supporter, pad, sensor cable, electrode cable, leg cuff, custom shoe, leg module, custom PC, cover for battery connector, custom battery charger, maintenance tool	Doesn't say	Doesn't say	Doesn't say	Doesn't say

Table 7 Lower-Limb exoskeleton comparison based on their mobility functionalities, characteristics and capabilities

ExoKools are used to help people re-gain the ability of walking⁵²⁰. There is only one available model, not like other research groups have offered (ExoLegs or other companies) and it is for people whose height ranges between 160 and 190 cm and weigh less than 80kg. The battery life is around 300 minutes, can reach a speed of 4.5 km/h and includes the capacity of climbing stairs. It has a degree of autonomy and provides a high-powered physical assistance, which means, according to the section 6.1.2.2.1. of the ISO 13482:2014, that the user cannot overpower the personal care robot (as opposite to those physical assistant restraint type that provide low powered physical assistance and, consequently, the user can overpower the personal care robot)⁵²¹.

Contrary to the impressions person carriers where not normally design in a user-centered manner – based on Andrea Sundaram’s experience, the EXO-LEGS project aimed at avoiding any assumption from the researchers’ side and at meeting the real needs of the end user. This is probably because these devices are fastened to the body, and they work in a symbiotic manner with the user’s movement. Following this idea, Virk et al. studied the 5 key design elements for exoskeletons: 1) mobility requirements

⁵²⁰ The project EXO-LEGS argues “since the exoskeletons mimic normal body posture, their use will have significant health benefits over wheelchairs (such as regaining normal bladder and bowel functions) as well providing the ability to exercise and increase muscle activity. It is well known that such exercising increases the cognition abilities as it increases oxygen flow to the brain giving another reason for choosing this option over wheelchairs”. See: <http://www.exo-legs.org/about.html>

⁵²¹ We chose the not-overpower option in order to increase the difficulty in the scenario of safety. The project ExoLegs is offering exoskeletons at max. 30% of the total force, so that the user could overpower in case of failure.

from the end users; 2) human gait analysis; 3) mechanical design; 4) embedded control system and 5) user interface⁵²²:

- 1) Mobility requirements. They conducted a survey among the end users to understand the most important mobility functionalities for the daily living as perceived by end users. Functionalities were also based on the difficulty in their technical implementation. Other questions were related to the aesthetics, ergonomics and other constraints.

The result was that the major features that an exoskeleton should have in order to gain more acceptance from the users and facilitate its market value were:

- Useful functionality
- Easiness to use, natural to use.
- Comfort
- Easy to wear (put on/ take off)
- Worn without help

Similar aspects were also supported by Dr. Sors Emilsson at the Newfriends2015 conference on the legal and ethical aspects of social robots in therapy and education⁵²³. Her very basic idea was to know how to reach patients from robotic-assisted, in that case, rehabilitation. The core of the problem is the same, either for rehabilitation or for ADL: “how can systems be built that makes it possible and worthwhile for Health Care Providers, Academia and Corporations to collaborate to make new rehabilitation technologies available to patients as quick as possible?”.

Exokool not only follow these elements, but it also has different versions with different sizes. This is done in order to cope with the wide variety of differences among users, not only in needs, but also in economical terms. Furthermore, it is important to have also different sizes that can easily fit the body of the person.

- 2) Human gait analysis. Concerning the human gait analysis, the focus of ExoKool is to help users with their walking impairments. These impairments can be gait alterations not directly related to any pathology (at risk to be considered a medical device); related to some pathologies that could have an indirect impact on normal gait – for instance, neurological pathologies (e.g. stroke, Idiopathic Parkinson’s Disease, Myelopathy, etc.); musculoskeletal pathologies (e.g. osteoarthritis or sarcopenia)⁵²⁴; or it could be associated with the fear of falling⁵²⁵

Although there is not that much difference in the gait between seniors and juniors⁵²⁶, aged population tends to go 10-20% slower than a young person, the steps are shorter, they have longer response time and they require more attention if there is an external perturbation⁵²⁷. Furthermore, each person is different. This

⁵²² Virk, G. S., Haider, U., Indrawibawa, I. N., Thekkeparampadom, R. K., & Masud, N. (2014, July). EXO-LEGS for elderly persons. In *17th International Conference on Climbing and Walking Robots (CLAWAR), JUL 21-23, 2014, Poznan, POLAND* (pp. 85-92). World Scientific.

⁵²³ Sors Emilsson L (2015) How to Reach Our Patients That Will Benefit From Robotic-Assisted Rehabilitation. Workshop Bridging the Gaps Between Different Worlds A Legal and Ethical Approach towards Assistive Robots: Risks And Solutions. New Friends Conference, available presentation slides at https://legalrobotics.files.wordpress.com/2015/11/lse_almere-okt-2015.pdf

⁵²⁴ Olivier, J. (2016) Development of Walk Assistive Orthoses for Elderly. Thesis 6947. EPFL, Lausanne, Switzerland.

⁵²⁵ We will talk more about the fear of falling in the cognitive aspects of this technology.

⁵²⁶ Jansen, E., et al. (1982). Normal gait of young and old men and women: ground reaction force measurement on a treadmill. *Acta Orthopaedica*, pages 1–5.

⁵²⁷ Olivier, J. (2016) op. cit.

is important because ExoKools, as the rest of exoskeletons, work in a “seamless integration with the user’s residual musculoskeletal system and sensory-motor control loops”⁵²⁸. In other words, exoskeletons work in a symbiotic movement with the users – the user’s gait. According to Olivier the user’s gait has different sequence of states (*see* Fig. 7):

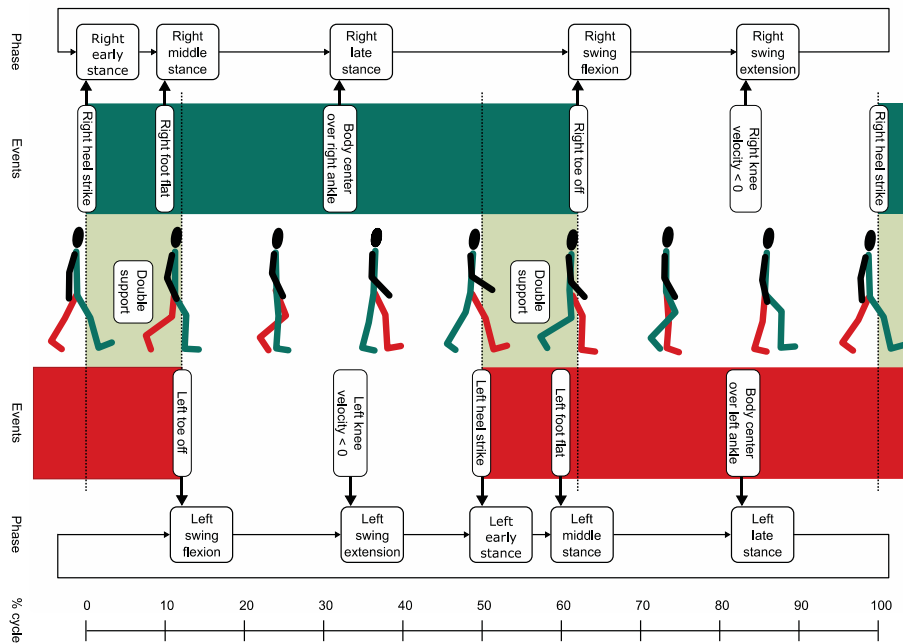

Figure 36 Extracted from Jeremy Olivier’s work on gait pattern identification, op. cit.

In his thesis, he reported “in this example for the knee joint, stance has been divided into three states. The early and middle stances are initiated by ground contact events at the heel and toe of the foot. Late stance is triggered when the user’s center of mass is estimated to be over the ankle. Swing flexion begins as the toe of the foot leaves the ground, and swing extension begins as the knee velocity is sensed to be less than zero”. The analysis of the gait pattern of the person is crucial in order to maximize its use and not provoke fatal outcomes. As the process of all this personal data is quite complex, some researchers have been thinking about using some general gait patterns and then use them as the basis for the individual gait patterns – although we doubt on its reliability (*see* users’ right safeguard). That is what differentiates the most PAR to person carriers: their personalized nature of the device.

- 3) **Mechanical Design.** Regarding the mechanical design, ExoKools works similarly to the HAL system. It detects the bio-electric signals of the person that wears the exoskeleton and reinforces the lower limb’s muscle power. This is done in a way the ExoKools helps the user in their movements: standing-up, walking, etc. As the

⁵²⁸ Tucker et al. (2015) op. cit.

ExoKool uses the bio-electrical signals and controls its power units, it is able to perform the task (the assistance in this case) in a symbiotic manner with the user.

Similar to the ExoLite exoskeleton from the Southwest University in Kursk we mentioned before, the ExoKools incorporate 12 rational degrees of freedom (6 on each leg) divided as follows: 3 degrees of freedom in the ankle joint, 1 degree of freedom – flexion in the knee; and 2 degrees of freedom enable the hips to change their position relative to the torso in the longitudinal and lateral directions⁵²⁹.

Future versions of ExoKool will have to follow bio-inspired materials and bio-inspired design patterns (similar to the ones used by Soft-Exosuits in Harvard Bio-Design Institute which, in fact, can be worn under the clothes of the user⁵³⁰). Further work on this will be carried out in the future⁵³¹.

- 4) Embedded control system. In order to control the exoskeleton, the physical human-robot interaction as well as the signal-level feedback, Tucker et al. ideated a control framework adapted from Varol et al. previous work⁵³²:

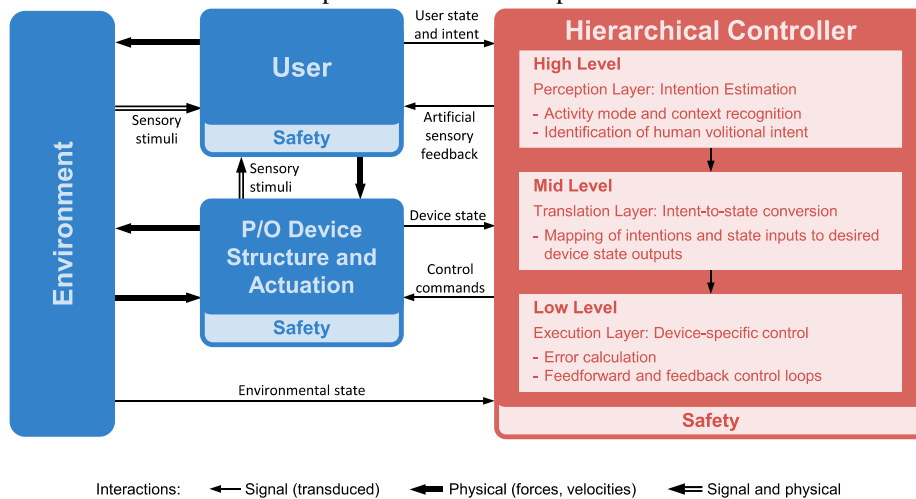

Figure 37 Generalized control framework for active lower limb prostheses and orthosis. Tucker et al. op. cit.

This framework includes the function of each of the components of the control framework, including also the environment, the user, the device and the hierarchical controller (divided in high-, mid-, and low level). For the hierarchical controller, an accelerometer, a gyroscope and a magnetometer are used to estimate the inclinations, joint velocities and accelerations. For the position and the velocity

⁵²⁹ Exomed.org op. cit.

⁵³⁰ See biodesign.seas.harvard.edu/soft-exosuits

⁵³¹ Beste Özcan, Institute of Cognitive Sciences and Technologies, ISTC-CNR, Roma, Italy. She is an interaction, social robot and wearable design researcher for the therapy of children with autism and education and her current researches focus on developing novel prototypes and interactions for efficient socio-emotional attachment, universal social robot design guidelines, biofeedback and emotion recognition of autistic children (link.springer.com/article/10.1007%2Fs12369-016-0373-8). For more information visit: www.beste-ozcan.com

⁵³² Tucker et al. op. cit. quote Varol, H. A., et al. (2010). Multiclass real-time intent recognition of a powered lower limb prosthesis. *IEEE Transactions on Biomedical Engineering*, 57(3), 542-551.

control intelligent brushless motor control methods are used (*see* safety for the estimation/execution of the movement).

This relates to the hardware of the devices, in a perfect communication among sensors, the environment and the device. Baud et al. showed it in a very simple schema (*see* Fig. 9). The importance of it is to see that in the system there are different things that interact: a computer or a smartphone, several sensors, the inertial measurement unit (IMU), a Wi-Fi access point and then of course several motors that, after estimating the intention of movement, then they execute the movement.

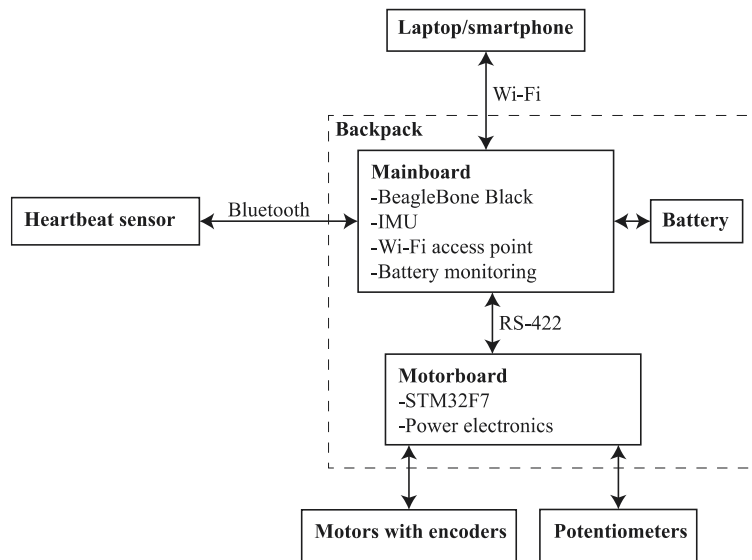

Figure 38 Baud's simplified example of hardware architecture that includes sensors and communication environment⁵³³

- 5) User interface. According to the study of Virk et al., exoskeletons should be comfortable, easy to use and effective at providing support to the user. That is why, every user interface should be designed in a way to translate the assistive forces from the device to the limbs in a perfect harmony with the user's intention of movement. Baud introduces a trunk and thighs interfaces because the movement is not estimated through a joystick. Concerning the embedded electronics, in the Baud's project, a little box is placed behind the back of the person, which includes: an antenna for Wi-Fi, the emergency button, the battery, the motors and a little fan to avoid over-heat of the system (this will be very important for safety reasons, *see* safety section). Fig. 10 is a picture that Baud used in MESROB 2016 to better show the embedded electronics placed behind the physical interface:

⁵³³ Baud, R. (2016) op. cit.

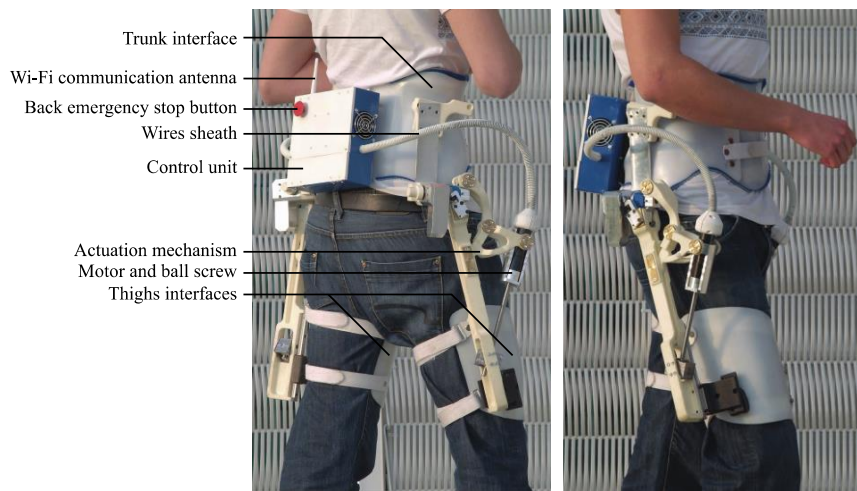

Figure 39 Control box of HiBSO, Baud, op. cit.

Beyond its design, one of the most important things in exoskeletons is their actual capabilities. For instance, although ISO 13482:2014 defines them as “personal care robot that physically assists a user to perform required tasks by providing supplementation or augmentation of personal capabilities”, lower limb exoskeletons help the user travel from point A to point B (as opposed to other upper-limb exoskeletons). This is a shared characteristic with person carriers, which do not work with all physical assistant robots, only those that are for lower body part (which is the part that humans use to travel). Some of the big differences with person carriers nonetheless are: 1) the user is freer as compared with the use of carrier, because they provide the capacity to walk on different types of floors, directions and it is normally the user who controls it; 2) the user can move around more easily because it is not as bulky as person carriers; 3) it gives the possibility to exercise and increase muscle activity, which has been found to improve cognition abilities and oxygen flow to the brain. Furthermore, although some carriers (like the i-Resyone) can be in upper position so that the user has the impression that is talking with the other people, it does not provide the sentiment of verticality that lower-limb exoskeletons can provide.

In addition, EXO-LEGS introduced an exoskeleton that could incorporate a navigation system. This capability would only be available in the deluxe version not in the rest. As we can imagine, the price will also be different (*see ethics section*). They divided the exoskeletons based on their mobility functionalities and depending on their characteristics and capabilities (*see Fig. 11*).

Basic exoskeleton	Standard exoskeleton	Deluxe exoskeleton
<ul style="list-style-type: none"> • Quiet standing (R1) • Straight walking on flat ground (R2) • Sit-to-stand/ vice versa (R3) • Crouching with support (R6) 	Basic plus <ul style="list-style-type: none"> • Walking/turning flat ground (R4) • Bending down R5) • Walk up/down stairs (R7) • Stepping over objects (R8) • Walking on ramps (new via Q1) • Crouching without support (R9) 	Standard plus: <ul style="list-style-type: none"> • Speed walking flat ground (R10) • Walking on uneven ground (R11) • Walking on slippery ground (R12) • Exercising (R13) • Leg to open/close door (R14) plus bio-monitoring and other support functions (physical activity, etc.), navigation, comms support, alarms, etc.

Table 8 Extracted from the Exo-Legs Project: Mobility Functionalities for Basic, Standard and Deluxe exoskeletons⁵³⁴

Although physical assistants' HRI is physical, there is a great difference between carriers and this type of robots: the assistant is, most of the times, fastened to the user's body (*see* the following chapter for non-fastened devices). Moreover, the assistant works through symbiotic movements with the user. The symbiotic nature of the device makes the physical HRI very complex: on the one hand, the HRI is extremely high because it happens in coordination with the user's intentions of movement and it needs to be tightly fastened to the user to truly help with the movement; on the other hand, the device works on a physical empathic level that aims at not interfering with the user's social interactions. To not interfere with the user's social interaction, this type of robots even aim, in the future, at being invisible. Of course the device at this stage are clearly visible. They are bulky and full of sensors. However, recent research on soft robotics, forecasts a future where exoskeletons will be worn under the clothes, which will allow a better social interaction⁵³⁵. That is why the modules on this type of robots will include a very simplified but personalized version of ethics (physical empathy) and dignity.

Based on all these characteristics and brief overview, we can proceed to analyze the exact meaning of the principles identified by the Robolaw project, which are used in the recommendations of the European Parliament to the European Commission.

4. Risk Scenarios

4.1. Safety

«At the ExoKlass different exercises are organized with music. Back and forth, back and forth; one, two, three, one, two, three. Although the exercises were not very strong, some of the users trembled when doing them and felt that their balance was not ok. The trainer recommended them to run with the devices; he said that the stability would increase. Paola did something wrong, her gait pattern changed and she suddenly felt afraid of the robot and her heart started beating very fast. She went out of the class to have some fresh air and drink some water. To get to the fountain, the user had to go up four stairs. Paola could go upstairs with no problem. She fell, however, when she went downstairs»

Safety safeguards will vary largely depending on whether the assistant is in the upper or in the lower limbs. In lower-limb physical assistant robots, which are the focus of this chapter, the safeguards will be applied to prevent the user from falling, slipping, tripping or colliding by estimating the movement of the user and executing it in a smooth way. Risks will mainly relate to⁵³⁶:

⁵³⁴ Extracted from Virk, G. S., et al. (2014) op. cit.

⁵³⁵ Harvard BioDesign Lab is working on soft wearable robots (mainly exoskeletons) that use innovative textiles to provide a more conformal, unobtrusive and compliant means to interface to the human body. *See* biodesign.seas.harvard.edu/soft-exosuits.

⁵³⁶ *See* M. R. (2015) et al. Control Strategies for Active Lower Extremity Prosthetics and Orthotics: A Review. *Journal of Neuroengineering and Rehabilitation*, 12:1.; Cicco, M. di et al. (2004) Comparison of

- the estimation of the movement: delay response between the motor commands and the generation of force;
- the execution of the movement: intent recognition errors, contact with moving objects, navigation errors;
- intrinsic to the user: either due to the invasiveness of the sensors or user perception of the device or the fear of falling
- extrinsic to the user (environmental conditions)
- or regarding the robot itself (all the ISO breakdown of hazards).

Similar to person carriers, physical assistant robots interact with the users in a physical manner. Both person carriers and physical assistant robots detect the intention of movement of the user and execute the task, that is, a movement. The big difference between them is that while person carriers have a sporadic low level interaction with the robot when performing the movement (e.g. because the user is only sitting on the robot), physical assistant robots tend to be fastened to the body of the user (although there are restraint-free types of PAR), they detect the intention of user's movement to thereupon execute a symbiotic movement with him/her⁵³⁷. Therefore, although hazard complexity in person carriers lied on open scenarios (unstructured environments, public roads), this might not be the case for physical assistants, as the fact that the robotic device is 1) fastened to the human body; and 2) works symbiotically with the user's movement, another level of complexity on the safety hazards increases. Safety in physical assistant robots will have to concern the environment, the user and the device itself in order to prevent any unfortunate scenario.

ISO 13482:2014 identifies risks solely for restraint-type physical assistant robots. These are related only to the instability that the attachment or removal of a restraint-type physical assistant robot can cause to the user (either when the exoskeleton is moving in these phases or not). ISO establishes some recommendations for the producers: they should design the robotic device in a way that it can be fastened and put on when the user is in a stable position (and that is very low-powered so that it cannot harm the user). For further protective measures, the industrial standard suggests the robotic device to incorporate a warning sound to indicate that its position is not the appropriate one (which is different from the warning sound in person carriers); to reduce (in case of moving in this face) the speed to a safety-related speed/force control. As an additional protective measure, the standard says that the removal of the exoskeleton will lead this device to be in "safe state".

To estimate the movement, the User Intent Recognition (UIR)⁵³⁸ is estimated through natural interfaces, for biological and practical reason. Indeed, "a lot of information is lost in the translation of biologically executed tasks into discrete events" and "delays are introduced when natural cognitive processes are encoded into an

Control Strategies for an EMG Controlled Orthotic Exoskeleton for the Hand. IEEE International Conference on Robotics and Automation, pp. 1622-1627; Noda et al. (2012) Brain-Controlled Exoskeleton Robot for BMI Rehabilitation. IEEE-RAS International Conference on Humanoid Robots, pp. 21-27; and H. Huang et al. (2011) Continuous Locomotion-mode Identification for Prosthetic Legs Based on Neuromuscular Mechanical Fusion. IEEE Transactions on Biomedical Engineering, vol. 58, num. 10, pp. 2867-2875.

⁵³⁷ see J. C. Moreno et al. (2014) op. cit.

⁵³⁸ F. Zhang et al. Preliminary Study of the Effect of the User Intention Recognition Errors on Volitional Control of Powered Limbs Prostheses. 34th International Conference of the IEEE Engineering in Medicine and Biology Society (2012)

imposed sequence of tasks”⁵³⁹. That is why in EXO-LEGS project the researcher wanted to lie on the idea of “curve registration” that is, on estimating the movement from an already general gait pattern, previously analyzed⁵⁴⁰. The estimation of the movement however can also be estimated through the physical interaction with the environment and the device⁵⁴¹; or by manual inputs like keypads, buttons or joysticks (as REX Bionics has⁵⁴²), voice commands, or eye movements⁵⁴³ even if they do not allow fast feedback or error connection⁵⁴⁴. Brain computer interfaces (BCI) have also been used even if that is more invasive than external sensors and it is still on its infancy⁵⁴⁵. HAL estimates the movement through bio-electrical signals (BES), and the EXO-LEGS project does it through electromyography

Internal and external factors thus condition the estimation of the movement, and this can lead to a failure of the device. It can happen that the device does not understand the intention of movement. This can totally clash with the free will of the person not only for not respecting a person’s intentions but also it can put at risk the user’s safety⁵⁴⁶.

Indeed, the electromechanical delay between the motor commands and the generation of force is a source of instability, as well as it is the time between transitions⁵⁴⁷, especially in lower-limb orthosis. Pons says that UIR “must be 100% reliable”. However, estimation has always its own scarcities⁵⁴⁸, systems are not 100% reliable yet and the delegation of action can cause further liability scenarios. That is why the researchers at EXO-LEGS project worked on an exoskeleton that could only assist for 30% of the physical force to the user. This way the user would remain in control of the device in case of failure of the system and could overpower it. It is true, however, that depending on the user, a 30% of the force could be a lot in order to hinder the overpower force of the user, especially if the device makes them feel tired: due to the device’s weight (it is very heavy, e.g. 14kg average) or because they are afraid of the device and they have a moment of confusion.

For the time delay between transitions, an automated pattern recognition system could be incorporated into the device. Machine learning could help to reach better accuracy in mode recognition but that has a very important limitation: complexity of real-world scenarios. Big data and the use of IBM Watson that compiles data from its conception could help to manage that amount of information, as it has been used in oncology contexts⁵⁴⁹. Yet, this also creates another uncertain point: the monopoly of data and the total reliance on the system.

⁵³⁹ J. L. Pons Rehabilitation Exoskeletal Robotics. The Promise of an Emerging Field. *IEEE Engineering in Medicine and Biology Magazine*, pp. 57-63 (2010)

⁵⁴⁰ See the user’s right safeguard section.

⁵⁴¹ M. R. r et al. Control Strategies for Active Lower Extremity Prosthetics and Orthotics: A Review. *Journal of Neuroengineering and Rehabilitation*, 12:1 (2015)

⁵⁴² See REX Bionics website: www.rexbionics.com

⁵⁴³ M. Duvinage et al. Control of a Lower Limb Active Prosthesis with Eye Movement Sequences. *IEEE Symposium on Computational Intelligence, Cognitive Algorithms, Mind and Brain (CCMB)*, 2011

⁵⁴⁴ M. DiCicco et al. (2004) op. cit.

⁵⁴⁵ T. Noda et al. Brain-Controlled Exoskeleton Robot for BMI Rehabilitation. *IEEE-RAS International Conference on Humanoid Robots*, pp. 21-27 (2012)

⁵⁴⁶ Zhang, F. op. cit.

⁵⁴⁷ H. Huang et al. Continuous Locomotion-mode Identification for Prosthetic Legs Based on Neuromuscular Mechanical Fusion. *IEEE Transactions on Biomedical Engineering*, vol. 58, num. 10, pp. 2867-2875 (2011)

⁵⁴⁸ In other contexts, estimation can be very critical. In the Google Patent US 8,996,429 B1 one can read that based on estimation ‘the robot may prepare food for the user using peanut oil. The user who may be allergic to peanut-based foods, may eat the meal and have an allergic reaction’. Food-induced anaphylaxis, in reality, affects multiple organ systems and hospitalization due to it has increased over these years

⁵⁴⁹ J. C. Ward Oncology Reimbursement in the Era of Personalized Medicine and Big Data. *Journal of Oncology Practice*, vol. 10, issue 2, pp. 83-86 (2014)

After estimating the movement, the device will perform it. In lower-limb devices (e.g. exoskeletons) risk of falling, slipping and collision/tripping when performing the movement are of major importance. Risks concerning unsafe/invalid motions, that is, if the exoskeleton moves exceeding the range of motion of the wearer, should also be taken into account. From the external viewpoint, obstacles can pose a risk to normal gait (e.g. stairs, objects, etc.). ISO 13482:2014, however, thinks that collision with safety-related objects, other robots, “fragile” safety-related objects, walls, permanent/unmovable barriers “are not applicable to restraint-type physical assistant robot”. The problem nonetheless is that ExoKool incorporates a navigation system on it that could lead the user to a risk scenario if it is not capable of detecting all these objects (especially when it incorporate the “autonomous mode”). This is a problem because within the “hazards due to localization and navigation errors” section, the standard itself mentions “navigation errors preventing reaching of goal location or avoiding safety-related objects”. The more capabilities exoskeletons will incorporate, the more other safety requirements should be applied to them (*see* consumer robotics). As a real example, the deluxe version of EXO-LEGS will have to incorporate navigation techniques that will, for sure, give the adequate directions to the users in order to prevent any unfortunate scenario.

For those obstacles that impede normal gait, several sensors could be added to the device as well as the proposed Terrain Recognition System (TRS) in Zhang et al.⁵⁵⁰. However, the increase of inputs creates more delay in response timing. The use of a cloud platform could help but then other risks might occur: dependence to the Wi-Fi connection, management of big data, data protection, etc.

Environmental-related accidents, also from the external viewpoint, are the first cause for falls in elderly⁵⁵¹. ISO 13482:2014 includes a detailed hazard breakdown where the environmental hazards are highlighted: high level of dust, sand, exposure to snow, ice, water or saline atmosphere. In each case, the solution proposed is to design the robot in such a way that foreseeable environmental conditions during the intended use do not lead to hazards. For instance: apply dust-resistant materials, seal electrical components, or even other additional protective measures, like including a forced ventilation, dust detection, air filters, etc.⁵⁵². Also if exoskeletons are kept within the limits of a pre-defined environment like the RoboGym, environmental conditions can still have an impact on them. Moreover, as the demand for ADL exoskeletons increases, special attention should be drawn to non-defined environments, as these will pose an even greater risk to users. The international standard recommends that the producer shall include some information for the users, like the duty for inspection, cleaning for the prevention of sand/dust/snow/ice, drying, and the maintenance and replacement of the parts.

Balance is the second cause of falls in elderly⁵⁵³. In the use of exoskeletons, balance is also a safety hazard, although travel instability is not applicable to physical assistant robots⁵⁵⁴. For Tucker et al. balance is crucial. They explain that balance can be at risk due to environmental conditions, or for unexpected terrain, but also for the transition switching; and this can provoke a fatality for the user. Jatsun et al. presented at RAAD

⁵⁵⁰ F. Zhang et al. (2011) Preliminary Design of a Terrain Recognition System. Conference Proceedings IEEE EMBS, pp. 5452-5455

⁵⁵¹ L. Z. Rubenstein. Falls in Older People: Epidemiology, Risk Factors and Strategies for Prevention. *Age and Ageing* 35-S2: ii37-ii41 (2006)

⁵⁵² ISO 13482:2014 part 5.15 “Hazardous Environmental Conditions”

⁵⁵³ *ibidem*.

⁵⁵⁴ *See* Annex A.1 Hazard item 59, ISO 13482:2014 Personal Care Robots.

2016 a motion control algorithm for exoskeleton push recovery in the frontal plane⁵⁵⁵, which could be useful to ensure stability during the gate life-cycle. Maybe in the future it would be a requirement for creators to incorporate safety balance algorithms similar to the zero-moment point (ZMP) applied by the Atlas humanoid robot from Boston⁵⁵⁶. These techniques have lately been used to successfully address dynamic balance in humanoid robots. Although exoskeletons are not humanoid robots, it is true that balance and stability are a crucial matter. Tedrake et al. showed that online ZMP re-planning and stabilization can be done in sub-millisecond computation times. This could help increase, indirectly, user confidence. This is especially important for exoskeletons that incorporate a special shoe and that help the user perform the movement from the feet to the hip, and which have a degree of autonomy. This stability algorithm that could maintain the user in standing position without falling would have to be done in a way that the protection of the user is, above all, protected. Another aspect that could improve stability is to include the possibility to run. In fact, most of the problems concerning stability disappear when walking at a higher pace⁵⁵⁷. However, we cannot imagine having the elderly run just to avoid stability without taking into consideration other aspects, like if this is good for their health or not.

In the case of a fall, some authors have argued that a wearable airbag could be used in order to enhance safety. In fact, Amit Goffer patented it in 2014⁵⁵⁸. The Patent reads: “a motorized exoskeleton system for facilitating locomotion for a user, the system including a motorized exoskeleton device, one or a plurality of sensors to sense one or a plurality of parameters indicative of a state in which a user of the motorized exoskeleton device is falling, and an airbag unit comprising one or a plurality of airbags configured to deploy in response to the sensed state”. When the system detects that the two legs are not on the floor (or that they support to the floor is lower than expected), then a fall is declared⁵⁵⁹. If the exoskeleton has the ability to detect a fall, then the built-in sensor block or the exoskeleton itself can make the airbag inflate. What it does not make that much sense in Goffer is when he states “the airbag can be inflated manually by the user (...)”: ISO 13482:2014 does not give instructions in this regard as its focus is on designing the robotic device to prevent any fall; and it does not focus on how to solve the problem when a fall occurs (which could be done embedding into the system this airbag for instance that inflates when a fall is detected). In any case, the inclusion of a protective stop should help reduce any possible fall, depending on where the button is located (in HiBSO is located behind the back of the user in the control unit), safety of the user will be diminished or enhanced (*see* autonomy section).

Sometimes intangible and intrinsic factors of the user can also limit the device performance. These can be physical, for instance, the user coughs, sneezes, or has an uncontrolled spasm; or cognitive, e.g. the fear of falling. Both are often disregarded by current standards, especially the cognitive ones even if acknowledged their importance⁵⁶⁰.

⁵⁵⁵ Jatsun, S. et al. (2017) Motion Control Algorithm for Exoskeleton Push Recovery in the Frontal Plane. In: Rodić, A. and Borangiu, T. (2017) *Advances in Robot Design and Intelligent Control*. Proceedings of the 25th Conference on Robotics in the Alpe-Adria-Danube Region. Springer Verlag Forthcoming.

⁵⁵⁶ Tedrake, R., et al. (2015, November). A closed-form solution for real-time ZMP gait generation and feedback stabilization. In *Humanoid Robots (Humanoids)*, 2015 IEEE-RAS 15th International Conference on (pp. 936-940). IEEE. Available at: groups.csail.mit.edu/robotics-center/public_papers/Tedrake15.pdf

⁵⁵⁷ See ansen, E., Vittas, D., and Hellberg, S. (1982). Normal gait of young and old men and women: ground reaction force measurement on a treadmill. *Acta Orthopaedica*, pages 1–5.

⁵⁵⁸ See US 20140005577 A1 Airbag for exoskeleton device

⁵⁵⁹ Goffer, A. (2014). Enhanced safety of gait in powered exoskeletons. In *Dynamic walking conference abstract-available online*. Argo Medical Technologies, Firewalk.

⁵⁶⁰ Olivier, J. (2016) op. cit.

Although not all intent recognition errors might cause feeling of instability to the user, the user needs to feel secure with the device during all gait cycle⁵⁶¹ including when attaching/removing the exoskeleton. The fear of falling, for instance, has been always very relevant to lower-limb impaired people⁵⁶². When users are afraid, heartbeat and respiration accelerates, they sweat, etc. and in some studies these reactions have been interpreted as harmful or dangerous⁵⁶³. Some authors have said that there is an avoidable “spiral of adaptation”, meaning that the user needs to get used to the device⁵⁶⁴: know how it works, be familiar with it, etc. There are currently no guidelines on how the spiral of adaptation should be modeled: thorough a driving test, a training course done by experts (which it could be given by the trainers of ExoGym but that would not ensure safety for those who have bought the device on their own), etc. It is accepted in literature that “emotional and psychological effects are important and require consideration”⁵⁶⁵ but there are no many indications on how to do it. For instance, it is not very clear what Panasonic means by stating “these robots are safe to use and offer peace of mind”⁵⁶⁶.

Confidence comes also with the feeling of comfort with the device. One study found that users had the impression of being like a Christmas tree due to all the sensors of the device⁵⁶⁷. Even if one study is not representative, it is true that social tendencies to customize marketable products have already had an impact on prosthetics. 3D-printing technologies can very easily print 3D prosthetics that can be customized according to the taste of patients. And although active orthotic devices are at the very early stage of the 3D printing process⁵⁶⁸, soon 3D printing techniques will reduce the cost of its production and this will bring about more easily personalized devices⁵⁶⁹. This is important because normally exoskeletons are done with materials that can be dangerous for the wearer. In fact, they are not normally worn directly over the skin of the user.

Other risks have to do with the level of invasiveness of the sensors and the energy involved in the performance. Tucker et al. argue that “the optimization to be performed is to maximize the richness of information while minimizing the invasiveness of the required instrumentation” and that “a further optimization for the controller may be the energy efficiency of operation”⁵⁷⁰. For the invasiveness of the implanted electrodes, it is argued that, electromyography is the least invasive technique⁵⁷¹, even if it is non-stationary and has cyclic nature. Souza et al. suggest also that environmental sensing can add an additional layer of safety⁵⁷².

ISO 13482:2014 put these risks at the environmental level: energy supply, emissions, environmental conditions, etc. but does not say much about exoskeletons.

⁵⁶¹ F. Zhang op. cit. and L. Z. Rubenstein op. cit.

⁵⁶² Reelick, M., et al. (2009). The influence of fear of falling on gait and balance in older people. *Age and ageing*, 38(4):435–440.

⁵⁶³ Eley, T. C., Stirling, L., Ehlers, A., Gregory, A. M., & Clark, D. M. (2004). Heart-beat perception, panic/somatic symptoms and anxiety sensitivity in children. *Behaviour research and therapy*, 42(4), 439–448.

⁵⁶⁴ H. Herr, A. Wilenfeld. User-adaptive Control of a Magnetorheological Prosthetic Knee. *Industrial Robot: An International Journal*, vol. 30, num.1, pp. 42-55 (2003).

⁵⁶⁵ J. Olivier (2016) op. cit. when quoting to Rubenstein, L. (2006). Falls in older people: epidemiology, risk factors and strategies for prevention. *Age and ageing*.

⁵⁶⁶ See <http://news.panasonic.com/global/stories/2016/44969.html>

⁵⁶⁷ Tucker et al. (2015) op. cit.

⁵⁶⁸ See the first 3D printed exoskeleton from EksoBionics. <http://www.ibtimes.co.uk/first-3d-printed-hybrid-robotic-exoskeleton-helps-paraplegic-woman-walk-again-video-1437038>

⁵⁶⁹ See the European project <https://www.symbitron.eu>.

⁵⁷⁰ Ibidem

⁵⁷¹ M. Atzori (2014) Electromyography Data for Non-Invasive Naturally-Controlled Robotic Hand Prostheses. *Scientific Data* 53.

⁵⁷² J. M. Souza et al. (2014) Advances in Transfemoral Amputee Rehabilitation: Early Experience with Targeted Muscle Reinnervation. *Curr Surg Rep* 2:51.

This is crucial nonetheless due to the fact that current exoskeletons do not last very long (an average of 2 hours maximum). This can be a problem if the user is not noticed of the low power battery. The exoskeleton should be able to show to the user how much battery is left and what kind of exercises can be done.

One relevant aspect that it has been highlighted by ISO is the “incorrect user body size assumption”. In the case of lower limb physical assistant robots, current exoskeletons offer very small sizes to fit the user. Possible solutions to this problem – as reported on Wikipedia - can be⁵⁷³:

1. exoskeletons could be of wider range of sizes,
2. users could be required to be of a specific physical size in order to be issued an exoskeleton,
3. the length of the exoskeletons could be adjustable.

The above-mentioned solutions still have some problems. For instance, the creation of wider or even personalized sizes could be very costly for the company issuing the exoskeleton⁵⁷⁴. Requiring a specific physical size to issue an exoskeleton might not sound very fair or realistic, especially when Wikipedia article quotes some rules concerning military aircraft rules⁵⁷⁵. The fact is that, sometimes this what companies do when they have certain limitations in the use of their devices, e.g. when the maximum weight to be carried by the exoskeleton is 80 kg⁵⁷⁶. The third solution seems the most reasonable. It is, in fact, the one followed by big companies as Cyberdine. HAL, that stands for “Hybrid Assistive Limb” introduces several elements to give users the possibility to adjust the device to different constitutions (and fit to the leg length, hip width, foot size, etc.).

Another important thing in safety is the possibility that safety could be dependent to the price of the model. In the chart presented at EXO-LEGS project, in concrete the deluxe version, includes the function of uneven and slippery terrain, which it is not included in the other version⁵⁷⁷. If a specific terrain is considered “deluxe” then we safety of the user may be compromised by where s/he lives.

One of the concerns that arises in robotics is the extension of the chain of responsibility. Moreover, “information of use” is also very relevant. It is meant primarily for end-users, but nothing is said regarding third parties, such as the trainers

⁵⁷³ Although many have argued that Wikipedia might not be a reliable source of information (Michael Gorman once said “a professor who encourages the use of Wikipedia is the intellectual equivalent of a dietician who recommends a steady diet of BigMacs with everything”, quoted by Reagle, J. M. (2010). Good faith collaboration: The culture of Wikipedia. MIT Press), Wikipedia highlights the limitation and design issues in powered exoskeletons. Among others, the adaptation to user size variation. *See*: https://en.wikipedia.org/wiki/Powered_exoskeleton. Concerning the use of Wikipedia, a recent study from YouGov in the U.K. has found that users trust more Wikipedia than the newspaper journalists. *See* it at <https://yougov.co.uk/news/2014/08/09/more-british-people-trust-wikipedia-trust-news/>. *See* also how the opinion on the use of Wikipedia on research at Jemielniak, D., & Aibar, E. (2016). Bridging the gap between wikipedia and academia. *Journal of the Association for Information Science and Technology*, 67(7), 1773-1776. For opinions for the use of Wikipedia *see* also: Heilman, J. M., et al. (2011). Wikipedia: A Key Tool for Global Public Health Promotion. *Journal of Medical Internet Research*, 13(1), e14. <http://doi.org/10.2196/jmir.1589>; Bateman, A., & Logan, D. W. (2010). Time to underpin Wikipedia wisdom. *Nature*, 468(7325), 765-765.

⁵⁷⁴ This could be solved if the company translated the price to the actual costumer as ReWalk did (*see* <http://rewalk.com/rewalk-personal-3/>). However, and as we will see in the ethic section, this does not go in line with the principle of justice and the access to this technology, especially when safety is involved.

⁵⁷⁵ Schopper, A. W., and Cote, D. O. (1984). Anthropometric Cockpit Compatibility Assessment of US Army Aircraft for Large and Small Personnel Wearing a Training, Warm-Weather Clothing Configuration (No. USAARL-84-10). Army Aeromedical Research Lab Fort Rucker AI.

⁵⁷⁶ Cyberdine has this limit, and it can be found at the very bottom of their website, in the specification: http://www.cyberdyne.jp/english/products/LowerLimb_nonmedical.html.

⁵⁷⁷ Virk, G. S., Haider, U., Indrawibawa, I. N., Thekkeparampudom, R. K., & Masud, N. (2014, July). *Op. cit.*

of the RoboGym. As people involved in the use of this robotic technology will increase, it will be also very important to guarantee the safety in all the life-cycle process of these devices, including at the implementation level. In any case, safety analyses can vary case-by-case. Depending on the context, the capabilities of the robot, as well as the technology applied to them, the risks scenarios will vary among devices.

4.2. Consumer robotics

«Paola and Claudia have decided to join RoboGym. They have never tried any robot technology before. They enjoy very much the octopus in the swimming pool. They were a bit scared at the beginning due to some Hollywood movies, but they like the robots a lot now. They are a bit afraid in the ExoKlass. Not because they think the robot will kill them as they thought the octopus would, but because they do not feel in control when they are with the exoskeleton. Paola said that she nearly fell, and Claudia experienced abnormal acceleration on her heartbeat. Both are eco-friendly and they are not sure if the use of so much energy and its plastic components go align with their principles»

In this chapter both certified and perceived safety are of paramount importance. As reflected in the case scenario, the perceived safety is very important in exoskeletons. Perceived safety is described as “the user’s perception of the level of danger when interacting with a robot, and the user’s level of comfort during the interaction”⁵⁷⁸. Although this definition was conceived for co-bots, it will gain a lot of importance in physical assistant robotic technology. As physical assistant robots work on a symbiotic basis and are fastened to the body, special attention will have to be drawn to the estimation and execution of the movement in both physical and cognitive layer. Being afraid of the device, for instance, not only affects the perfect performance of the device, but it may also cause other side effects, i.e. heartbeat accelerates, hands sweat. These cognitive aspects concerning the perception of the user of the device are crucial for the performance/implementation of it.

Currently, there are no standards or regulations for producers or creators to mitigate the hazards linked to the perception of the user. Few researchers, until the article of Salem et al., have actually addressed this fact⁵⁷⁹. On the 2015/2103(INL) European Parliament Draft Report on Civil Law Rules on Robotics (May, 2016), the European Parliament mentioned something very important: “You are permitted to make use of a robot without risk or fear of physical or psychological harm”. The European Parliament included this provision within the Annex to the Motion for a Resolution: Detailed Recommendations as to the Content of the Proposal Requested, in one part called “license for users”. This will gain more importance in social robot technology, as they will be expected to be trustworthy⁵⁸⁰.

Concerning the certified safety, identifying the appropriate categories is fundamental: a robot should be assessed with a particular and recognized category in order to avoid misleading consumers, apply the appropriate safeguards, and receive

⁵⁷⁸ Bartneck, C., Kulić, D., Croft, E., & Zoghbi, S. (2009). Measurement instruments for the anthropomorphism, animacy, likeability, perceived intelligence, and perceived safety of robots. *International journal of social robotics*, 1(1), 71-81

⁵⁷⁹ Salem M. et al. (2015) op. cit.

⁵⁸⁰ Ibidem.

proper funding (if the device is a truly medical device maybe it could benefit from the social security of the country. The European Union might have chosen another perspective⁵⁸¹.

The proposal for a Regulation of the European Parliament and of the Council on medical devices, and amending Directive 2001/83/EC, Regulation (EC) No 178/2002 and Regulation (EC) No 1223/2009 for medical devices⁵⁸² intends to give clarity to those products that could create confusion because they are very similar. When the regulation talks about between medical and non-medical products, it means that those devices that are clearly non-medical but also have a medical version (for instance the exoskeleton HAL has its medical and non-medical exoskeletons) will have to follow the regulation on medical device (if it gets finally approved of course). The extension of the medical device protection would force robots to comply with the same requirements as those for medical devices regardless of the two different standards that govern these in the industrial world (*see* chapter 2).

One of the reasons why this might have happened is because current standards are released before government's regulations on the topic. Because of that, when a binding piece of legislation is released afterwards, it may even change the entire corpus of the standard. In addition, standard's nature is strictly static. Standards have little flexibility, which is in contrast with the continuous changing and mixing of robot categories: segways that transform into mobile servant robots, exoskeletons that incorporate navigation techniques, etc.

Paola and Claudia raised a very important concern on environmental aspects, which are part of the consumer protection. There is not that much effort to produce eco-robots without carcinogenic products or tones of plastic. As some companies like EksoBionics use 3D printers to print the exoskeletons, but little is known about whether this technology is eco-friendly. A 3D printer company recently explained that current 3D printers cannot be fully eco-friendly as they use a lot of energy and they involve the use of several plastics⁵⁸³. They also admitted that considering the whole life-cycle process, the initial processes and the disposal of robots involve heavy environmental pollution. There are promises stating the fact that 3D printer technology has an unlimited potential and might also be eco-friendly in the near future. However, further research is needed on this aspect.

Having a product in different sizes, avoid discrimination, and increase access to the technology are crucial questions for consumers. Different types of exoskeleton with different prices could help (or not) avoid these discrimination scenarios. The EXO-LEGS project (and ExoKools) has three different versions with different prices. However, this differentiation might not always be good if safety is enhanced differently in the three categories (*see* Fig 11 again).

4.3. Liability

«David started RoboGym in 2016, when it was first opened. He is 67. He did not want to use it because he felt young, but her wife pushed him to go. After some time, he liked it very much. When the wife retired 2 years later, they moved to the coast where there

⁵⁸¹ This connects with the legitimacy that we talked in chapter number two, and the existing differences between binding pieces of legislations and non-binding pieces of legislation, like laws (in this case European directives and regulations) and standards (from industrial bodies like ISO).

⁵⁸² Available at: <http://data.consilium.europa.eu/doc/document/ST-9364-2016-REV-3/en/pdf>

⁵⁸³ *See* the company My3DConcepts, in especial their blog concerning the eco-friendliness of 3D printers: <http://my3dconcepts.com/explore/eco-friendly/>.

was not RoboGym. David not only missed it, he started feeling pain in his lower limbs. He went to his doctor and made some radiographies. They found out that the muscles had been activated in an abnormal way. The doctor asked him what he had been doing during last 6 months. After explaining him all about RoboGym, the doctor said that it could be probably the cause of that abnormality and suggested to claim for damages. David, however, does not have any prove that RoboGym was the cause, as he felt good when he was going there»

As we have already mentioned, Law is worried about the effective occurrence of harm. The main question to be answered is how to allocate responsibility when harm occurs. In general terms, ISO 13482:2014 establishes several safety requirements and protective measures for physical assistant robots if used for personal care purposes, but nothing is said in the responsibility (as it is not the scope of any industrial standard, as they are not the entitled to establish consequences for violations of the standard).

Regarding physical assistant robots, internal control failure and external factors can cause direct harm to the users. This harm can be caused by normal or anomalous robot behavior. That is why it is important to ensure a three-fold safety: environment, subject and the robotic device itself⁵⁸⁴. Beyond these components, there are more persons involved in the use of the exoskeleton (at least in this scenario but also in other contexts, like in rehabilitation with the intervention of the therapists as secondary users, and then third parties). Complexity will also be greater when a cloud platform is used to interconnect such devices, where it might not be clear which are the relevant parties, their roles and the contract ecosystem⁵⁸⁵. This is important especially in the case of the scenario where the user may bring the device to the gym, which may be then connected to the gym resources for many reasons.

As we said before, ISO and IEC certifications compliance may allow robot manufacturers to be exempt from product liability when they did what they could according the available knowledge to discover any possible defect. However, some problems arise if we only apply this framework:

- This industrial standard is brand new not only for creators but also for certification companies, so a lot of practice and information might be lacking.
- Certification companies do not have any responsibility for any mistake these devices may have, but, at the same time, having the certification is a *condition sine qua non* to market the product⁵⁸⁶.
- These certification companies follow their own criteria and, as we have seen, some robots have been assessed under the wrong category (*see* person carrier's chapter).
- Safety issues are not the only things that the creators of the technology should care about; cognitive aspects involving that technology are also crucial, so is also accessibility (i.e. creating low-cost products for the general user).
- Indeed, although emotional and psychological aspects are fundamental in physical assistant robots⁵⁸⁷, the ISO 13482:2014 does not offer any guidance in

⁵⁸⁴ Tucker et al. op. cit.

⁵⁸⁵ Hon, W. K., Millard, C., & Singh, J. (2016). Twenty Legal Considerations for Clouds of Things. Available at SSRN.

⁵⁸⁶ Machinery Directive says so Art. 5 f) "affix the CE marking in accordance with Article 16"

⁵⁸⁷ Olivier, J. (2016) op. cit.

that respect, and we cannot be sure that these aspects have been taken into account when the robot was designed, and this is exacerbated by the emergence of “cognitive exoskeletons” (see user’s rights safeguards section)⁵⁸⁸.

- Prospective liability scenarios are not taken into account and there is no binding regulation that states how people should claim for damage in case of harm due to an exoskeleton.
- Furthermore, privacy violations (see next section) do not come along with harmful scenarios, especially physical harm, although it is considered a fundamental right in the EU and worldwide.
- Nothing is established for the life-cycle process for these devices, including the implementation,
- There are no established consequences for any violation, for any company that fails complying with the requirements set out by the standard.

A problem occurs when harm is not immediately evident or recognized. Datteri when quoting Hidler et al. says that, because the users have never used a similar technology, they might not be aware of how their muscles were being activated before and after the use of the device. In study case, the users’ muscles were activated in an abnormal way. The problem lied on the fact that they could not provide reliable feedback to physicians or therapists because they lacked information on how to do so⁵⁸⁹. Their example was more related to medical robots, but the extension of the medical device regulation to non-medical personal care robots makes us think that this could be also the case in non-medical personal care robots. Retrospective liability should apply if there is a causal link between the robotic device and the future harm, (especially if strict liability is preferred, as the European Parliament seems to highlight, see below).

This kind of “prospective” liability is very different in person carriers, since it is more obvious that the occurrence of harm will come right after an accident. Although the exoskeleton could provoke a similar scenario to the person, i.e. when the person falls due to a system failure of the exoskeleton, it is true that these devices could be involved in some prospective liability scenarios. More qualitative and quantitative data can be useful to know the likelihood of occurrence and whether some extra safeguards should be implemented. In line with this, some authors recently argued that the use of robots in highly unstructured environments and diverse scenarios (and they include in the example prostheses and exoskeletons) will provide more reliable data⁵⁹⁰. However, should we allow the occurrence of these accidents in order to have the actual data? This is not certainly how it works with airplanes, and it is surely scary, especially because these robots are fastened to the body of the person. If we know in advance the danger of this technology, it will be easier to apply the precautionary principle or at least further measures to protect users from any harm.

In any case, the roboticists should be able to provide users with enough information and techniques so that appropriate feedback could be given. This can be done, for instance, using a feature offered by Retiatech⁵⁹¹. The system MovMe offered by Retiatech consists of two inertial sensors that detect the amplitude, speed and acceleration of the movement. These sensors can perform motion capture of a joint valuing all measured parameters. This would provide permanent information on the

⁵⁸⁸ See <http://www.lockheedmartin.com/us/innovations/020916-webt-cognitive-exoskeleton.html>

⁵⁸⁹ E. Datteri. (2013) Predicting the Long-Term Effects of Human-Robot Interaction: A Reflection on Responsibility in Medical Robotics. *Science Engineering Ethics* 19, pp. 139-160.

⁵⁹⁰ See Bertolini, A., et al. (2016). On Robots and Insurance. *International Journal of Social Robotics*, 1-11.

⁵⁹¹ See the company retiatech.eu

relative position of each sensor in relation to the other, allowing measurements of high precision, with negligible errors as compared with other measurement systems. This could be an effective way to provide trusty feedback, and patients do not even need to know whether their muscles are being activated in an abnormal way.

Following the European Parliament, “whereas, as regards non-contractual liability, Council Directive 85/374/EEC of 25 July 1985 can only cover damage caused by a robot’s manufacturing defects and on condition that the injured person is able to prove the actual damage, the defect in the product and the causal relationship between damage and defect (strict liability or liability without fault)”. The big problem is how to justify what is included in the available knowledge mentioned by the product liability directive, and whether legal/ethical aspects are included as well (e.g. privacy by design, ethics by design). For instance, if push recovery and very strong stabilization algorithms are available, should they be included in the design for lower-limb exoskeletons? Currently, there is no obligation to include this kind of algorithms to exoskeletons. Consequently, it is quite hard to allocate responsibility in case of failure. The maintenance of strict liability rules could help the users but we are not sure how the industry will respond to it.

Concerning the legal/ethical aspects, although there are already risk identification systems, these systems are strictly technical and do not identify legal or ethical risks. This might change in the future with the standard BS 8611:2016 on the ethical design of robots. The problem, again, is that these standards come at a price, they are not available to the general public, and are written by the industry. Furthermore, this standard BS 8611:2016 is from the UK standard organization body, which might not be generally applicable in other countries. Apart from this, the fact that the personal care robot standard does not include any reference to psychological aspects of the user (apart from stress due to posture/fatigue) seems a reason enough to believe that the protection of the user is not completely safeguarded. In fact, it also remains uncertain if physical assistant robots could cause any emotional harm in the legal domain due to frustration, depression, dependency or even the cosmesis of the device. In any case, if the regulation on medical devices is approved, the product liability will have to be modeled according to this corpus and, of course, all the safeguards will have to be applied differently.

Although the ISO is done in a way that leads the creator to write down information of use for users, nothing is said on the actual implementation of this robotic technology nor if the users should be trained, nor even if the trainers – like in the case of the RoboGym – should have to be trained. However, until what extent the robot creator is obliged to take into account all these aspects? There is no clarity in this respect, and although the creator is obliged to establish the conditions of use of the device, it is not clear whether there should be specific guidelines for different users. In this regard, although the ISO 13482:2014 highlights the fact that future versions of the standard will include specifications for different types of devices and different types of users, it seems irresponsible to leave creators just with the current guidelines as they are. However, what happens when we are in front of a BYOD scenario? Should the gym be responsible for the occurrence of harm?

According to the Art. 15 Machinery Directive, member states can apply all the procedures that “deem necessary to ensure that persons, and in particular workers, are protected when using machinery”. The machinery directive talks about “implementation”. However, this directive refers to workers and machinery but it is not precisely for the users of physical assistant robots (or, by extension, other personal care robots). In fact, the directive is not very clear whether they are considered “machines”, and it does not clarify the responsibility assumed by the gym in this case.

On the other side, there is little research on reasons why standard bodies are not liable. Standards are mostly only voluntarily adopted, they are strictly related to countries (because countries are part of the bodies) and they inspire future regulations. The problem is that the interests of the industry might not be aligned with the interests of the users, especially when addressing ethics (*see* especially next chapter). There are no established consequences for any violation of this precise technology within the member states. As we mentioned in Chapter 2, none of the member states have established still any regulation that precisely addresses the use of exoskeletons, especially if used for ADL (nor of personal care robots in general).

The three-level of control strategy for correct functioning proposed by Tucker et al. (back on Fig. 8) could be very useful to allocate responsibility. Even if the chain of responsibility is longer due to the number of controllers involved in the decision-making process, a clearly defined hierarchical controller (high-, mid- and low- controller) could help identify who caused the problem.

Another initiative used in robotics that could help clarify these aspects is the use of different testing zones for robotic technology. Centers for drones or wheelchairs already exist and some examples on the U.S. army testing this technology can be found in several articles⁵⁹². However, there is actually no information about the creation of a testing zone where to test exoskeletons. Furthermore, this could help prevent all the *ex ante* problems linked to this technology, but not the *ex post*. Normally the inclusion of a black box could help allocate responsibility in case of failure. Of note, restricted access to those black boxes or encryption should be the rule to avoid privacy infringements.

Nevertheless, the problem still remains on the autonomy of the system. If the system is autonomous (as the chart we showed in chapter 3) then the extension of responsibility to the creator of the device might not be that clear, especially if the device has decided, on its own, how to actuate. This is also more complicated with the use of cloud robotic technology and data portability: if the parameters of one exoskeleton are downloaded to another exoskeleton, it is not clear if any harm should be attributed to the producer of the first device – due to a portability failure - or to the producer of the second exoskeleton – due to a failure in the applicability of safeguards.

Although the European Union perspective and the General Data Protection Regulation (GDPR, *see* next section) when talking about “data portability” seem rather simple, it is not clear who is responsible (maybe both exoskeleton producers complied with the regulation but there are some unsolvable incompatibilities).

4.4. User Rights Safeguard

«[RoboGym Announcement] If you forgot to BYOD, don't worry, RoboGym has everything you need to exercise. The classes have enough robots for all the attendees and they are very user-friendly. RoboGym offers the possibility to download into the gym's devices the parameters kept in your own device through cloud robotics. If some systems are incompatible, the user will have to bring their own device or to re-train the new exoskeleton.

⁵⁹² Ackerman, E. (2015) DARPA Tests Battery-Powered Exoskeletons on Real Soldiers IEEE Spectrum (*see* <http://spectrum.ieee.org/video/robotics/military-robots/darpa-tests-batterypowered-exoskeletons-on-real-soldiers>) or this latest news: Blennerhassett, P. (2016) U.S. military to test SFU-invented bionic exoskeletons. Gizmag (*see* <https://www.biv.com/article/2016/7/us-military-test-sfu-invented-bionic-exoskeletons/>).

The gym has bought several exoskeletons from the company Exoperfekt S.L. The company sells the device and also offers maintenance and updating services. Every 2 months, the exoskeletons are automatically updated. The gym is very happy with the service, as they improve substantially the performance of each device. Users are also very happy. Maria, a patient, feels as if the device knew already her movements»

Privacy concerns, even if highly important to the legal community, are perceived differently in terms of HRI: privacy is more related to the invasion of personal/private space caused by robots, something proxemics is addressing already⁵⁹³. The problem is that the symbiotic movement of physical assistant robots, as well as the fact that most of them are fastened to the human body (restraint type), have canceled the applicability of proxemics in this case. So instead of proxemics, and its translation to social awareness scenarios (that we will see with social robots), privacy of the user and the invasiveness to one's own space gains more importance in this scenario. Furthermore, a lot of personal sensitive data will have to be processed.

And this is because physical assistant robots need to track the movements of the patient, control and monitor the use of the device, and perform a movement in real time. This information is normally used for the device to work but also, for instance in rehabilitation contexts, for therapists to know what treatment should be applied, if there is any improvement in the patient's disease, etc.; or for instance in the RoboGym it is done in a way that trainers can also monitor some of the exercises and the results. Of course, the users have also access to this data. Protection should be granted to both users who allow their data to be processed and to those who do not. This is because there is lately a tendency of the "quantified self" movement, that is, people that use the available technology to collect data from themselves and improve their quality of life⁵⁹⁴. Independently of the trend of the movement, it is true that this has become a crucial aspect for people suffering from some injuries or an accident and who want to be monitored all the time. Swan actually thinks that this is going to be how care will be delivered in the future⁵⁹⁵.

Contrary to person carrier where mainly behavioral data was collected, within physical assistant robots a variety of data can be collected, especially biometrical data. This is because the device needs to be personalized and be able to work in a symbiotic manner with the user's movements. To do so, all the data concerning this performance needs to be used, which is highly variable and depends either on internal factors, such as age, mental state of the person, physical strength, or any pathology that indirectly is affecting the person's gait; or external-to-the-person factors like the quality of the surface, the lightning, etc.⁵⁹⁶.

Several researchers have realized that the amount of data they need is a bit too much to be processed all the time from the very beginning. Therefore, Virk et al. introduced the concept of "curve registration". This reminds us of the use of pre-configured maps for autonomous driving cars that tried to avoid the construction of the map from scratch.

⁵⁹³ M. Walters et al. An Empirical Framework for Human-Robot Proxemics. EU Integrated Projects COGNIRON and LIREC (2009)

⁵⁹⁴ Swan, M. (2013). The quantified self: Fundamental disruption in big data science and biological discovery. *Big Data*, 1(2), 85-99.

⁵⁹⁵ Swan, M. (2012). Health 2050: The realization of personalized medicine through crowdsourcing, the quantified self, and the participatory biocitizen. *Journal of Personalized Medicine*, 2(3), 93-118.

⁵⁹⁶ See Virk, G. S. et al. op. cit. pages 3-4.

The curve registration requires the study of various human gait aspects in different persons in order to determine the walking patterns of the users, which could be normalized. From the ones that could be normalized, an optimal gait pattern could be generated. These normalized gait patterns could be a “good starting reference trajectories for the design of exoskeleton controllers, and later be able to adapt to individual gait patterns”. This would lead to the collection of incredible amounts of data from a lot of people and this could be possible only through big data techniques.

In fact, some researchers are even thinking of merging the two concepts of big data and cognitive aspects of exoskeletons and create the “cognitive exoskeleton”⁵⁹⁷. This is interesting because, beyond the fact that exoskeletons will probably have to apply the medical device regulation, the creation of a cognitive exoskeleton would imply far more types of data compared with current exoskeletons, such as heart rate data, blood oxygen data, brain waves data, etc. Some physical lower-limb exoskeletons are also using some of this data in order to monitor their users, especially if they are in the research phase of the devices.

The case scenario above mentioned relates to the use of personal data from companies that have already sold their devices to the users, e.g. the case of a smart TV that was processing personal data from the users to ameliorate their system⁵⁹⁸. The difference is that during a research project, there is normally an ethical committee (Institutional Review Board, IRB) that approves and controls how the collection and processing of personal data is carried out. Once the company has put a device into the market, it is more difficult for an agency to control it (although the Data Protection Agencies are very active on this). This is very important because the data controller of this technology needs to be clearly identified. If the company remains the controller of this data because it is offering a service and they are updating their devices accordingly, they should mediate an agreement not only with the gym but, and especially, with the users. If the gym has already collected users’ informed consent at the beginning of the registration, this procedure could be avoided. The question is whether users have truly been informed or whether the gym can do different activities with the general consent from the users. An active Data Protection Authority should be reviewing all these cases.

In healthcare domain, the European Union gives special status and stronger protection to health data and considers it as “sensitive data”. First, the collection and processing of personal sensitive data needs to be balanced against other compelling interests (such as the protection of a person, the invasion of privacy); second, unequivocal informed consent of the user is needed; and third, the data collected and processed needs to be proportionate (for the intended task/the purpose which motivated the processing). In 2018, the data controller should carry out an impact assessment on the processing of this data to the data subjects and apply the pertinent remedies.

Some steps towards the creation of standards to anonymize data have been taken in wearable security⁵⁹⁹, although the anonymisation of data does not involve per se the loss of the “personal” feature of data. In fact, although some companies advocate that only scattered information is processed (normally to escape from the data protection legislation) Article 29 Working Party already warned that “the processing of that information only makes sense if it allows identification of specific individuals and treat

⁵⁹⁷ See <http://www.lockheedmartin.com/us/innovations/020916-webt-cognitive-exoskeleton.html>

⁵⁹⁸ BBC (2015) Not in front of the telly: Warning over 'listening' TV. Available at: www.bbc.com/news/technology-31296188.

⁵⁹⁹ Similar to Hamblen M. (2015) UL Creating a Standard for Wearable Privacy and Security. Computerworld. Available at: www.computerworld.com/article/2991331/security/ul-creating-standard-for-wearable-privacy-and-security.html.

them in a certain way”, thus it should be considered as information relating to identifiable individuals⁶⁰⁰. Physical assistant robots are designed to be personal data collectors as they work in a symbiotic manner with their user, despite being in non-medical contexts. In fact, they are fastened to the user to help a person perform actions according to the user’s body characteristics and normal gait. The “household exemption” would neither apply because all data is transferred to many different people (e.g. manufacturers, trainers at the gym, etc.) and not for household activities⁶⁰¹.

The security practices enshrined in the international standard ISO 27001-27002 about information privacy are recommended to ensure data protection compliance; although with the entering in force of the General Data Protection Regulation, other principles will have to be taken into account, like privacy by design principles or the right to be forgotten. There are no studies that have tackled whether the forgetting parameters of some of these devices comply enough with the future right to be forgotten or not. In fact, this right may clash also with machine learning capabilities, although there is not much interdisciplinary work at this regard⁶⁰².

Concerning the protection of personal data, the European Parliament report mentions the concept of “data ownership”. However, the Parliament does not say much about the content of “data ownership”, it only mentions the importance of including that in the future regulation. Unfortunately, the GDPR does not include any provision concerning strictly related the ownership of data either.

4.5. Autonomy

«Francesco used to like very much his wheelchair. His doctor one day, however, said to him that if he would not do sports, he would have a higher risk of heart attack; and recommended him to use an exoskeleton. Francesco agrees and buys one. The first days he used it few minutes, at home, just to try it. When he felt confident enough, he put the autonomous mode on and went for a walk to the park. He decided to get the bus. Waiting the bus, he sneezes and the exoskeleton starts walking. He nearly crosses the street where cars were passing by. Obviously, Francesco, anxious, wanted to stop the device. He was afraid of it and wanted to stop it. The protective stop, however, was behind his back and he could not reach it»

The autonomy issues related to lower-limb exoskeletons largely differ in upper-limb exoskeletons as upper-limb exoskeletons are not meant to make a person move around (from one point to nother), but only to move the upper limbs of the body. Lower-limb exoskeletons, on the contrary, are more similar to wheelchairs, with certain advantages. For instance, lower-limb exoskeletons provide users with the ability to travel on different types of ground, ascend/descend stairs, and step over/reach over objects. As

⁶⁰⁰ Opinion 04/2007 on the concept of personal data. Article 29 Working Party. Available at: http://ec.europa.eu/justice/policies/privacy/docs/wpdocs/2007/wp136_en.pdf

⁶⁰¹ Article 3(2) of the current Data Protection Directive (95/46/EC) states that the Directive shall not apply to the processing of personal data done by a natural person in the course of a purely personal or household activity. See: ec.europa.eu/justice/data-protection/article-29/documentation/other-document/files/2013/20130227_statement_dp_annex2_en.pdf

⁶⁰² Kieseberg, P., Li, T. and Fosch Villaronga, E. (2017) Humans Forget, Machines Remember: Artificial Intelligence and the Right to Be Forgotten. 7th Annual Internet Law Works-in-Progress Conference, Santa Clara University School of Law, 4 March 2017.

they are less bulky than wheelchairs, moving around in small places like home will be easier for a person with an exoskeleton than with a wheelchair. Moreover, as the exoskeletons work in a symbiotic manner with the user's body, their use will have significant health benefits, they will be able to empower the ability to exercise and increase muscle activity – which could not be possible with the use of wheelchairs.

Physical assistant robots help users to perform a certain task. Contrary to mobile servant robots, the exoskeleton robotic device empowers the user providing a percentage of physical assistance to carry out a task. The difference with person carriers is that the user in the physical assistant robot does not perform this task alone: it is a shared task performed jointly between the human and the robot. This changes completely the autonomy scenario: although the autonomy continues to rely on the human, in order to get the independent living, the user needs to share the tasks with the robotic device⁶⁰³.

In other words, taking into consideration the autonomy of the user and the type of assistance he wants to receive (as defined by the Robolaw project), these devices provide physical support so as not to clash with the autonomy of the user. After seeing the different scenarios and comparisons of the different devices (see Fig. 6), this situation might change due to different reasons: 1) there are exoskeletons that the user cannot overpower; 2) there are fast unexpected scenarios; 3) these devices will increasingly include “cognitive support”, which could clash with the decision-making process of the user; 4) the autonomy on the navigation system incorporated into the device can have an impact; and 5) the dependence of the user on the device should be considered.

As written in ISO 13482:2014, there are two types of physical assistant robots, those that the user can overpower and the other ones that the user cannot overpower. Although the EXO-LEGS project wanted to emphasize the fact that for ADL it was necessary to put the assistance level at 30% of the physical force for the user, the truth is that the same corpus foresees another type of robotic devices. That is why in our case scenario, ExoKools can provide an assistance level up to 60%. This means that the user totally relies on the device and, on some occasions, the device will be stronger than the user. It is true that we have already argued that the 30% of the physical assistance is very relative, and it depends on how strong the person is, and how the device is designed. In the cases where the robot cannot be overpowered by the user, safety should be ensured. If these robotic devices are going to be marketed soon for ADL, some concerns regarding buying an exoskeleton that is stronger than the users should be taken into account⁶⁰⁴.

The video of the new robot dog of Boston Dynamics defeated by a banana peel went viral on the internet in 2016⁶⁰⁵. Boston Dynamics that created at that time one of the best stability algorithms (as we have already mentioned in the safety section) released a video where an unexpected banana peel lying on the floor made their new robot dog fall. What we try to highlight with this example is that unexpected terrains can happen and can be undetectable by the robot. The speed at which the robot falls and the way it is destabilized make it impossible for the algorithm to overcome this problem. The question here is: until what extent the exoskeleton should be programmed in order to avoid all these fatal outcomes? If the robot falls, it can get repaired (in the robot dog)

⁶⁰³ It is true, however, that the evolution of mobile servant robots to companion robots will make this be re-phrased as lots of the activities that will be programmed in companion robots will be co-activities which will involve both the user and the robot, even if, of course, in a different manner this scenario pictures.

⁶⁰⁴ This question is inspired by the sensationalist title of the Gizmag article Borghino, D. (2016) Would you buy a car programmed to kill you for the greater good? <http://www.gizmag.com/driverless-car-ethics/43926/>

⁶⁰⁵ See Place, N. (2016) Watch This Robot Dog Slip on Banana Peels. The Daily Beast. Accessed online at: www.thedailybeast.com/articles/2016/06/27/watch-this-robot-dog-slip-on-banana-peels.html

but if the robot is fastened to the human body and this falls, the situation is certainly different because it can cause harm to a person. Although the responsibility issue might be solved applying the strict liability regime as the European Parliament suggested to the Commission, it is not clear what is the degree of autonomy for exoskeleton providing more than 50% physical assistance – which means the device cannot be overpowered by the user – and if it needs extra safeguards or not. The ISO 13482:2014 does not provide any answer about this.

Regarding balance and instability, Tucker et al. suggest that providing feedback to the user as reassurance that the device has correctly identified the next intended movement could help to correct balance. They also consider that using brain activity to provide high-level commands to the device could be very useful to further execute the movement. The question is how to implement human control check to impede certain decisions taken by the robotic system that could affect the person's life or integrity.

Within the “stress, posture and usage hazards, the ISO 13482:2014 establishes as a hazard the “poor user interface design and/or location of indicators and visual displays unit”. In the HiBSO project for instance, the protective stop is situated right behind the exoskeleton, just in one of the corners of the control unit. However, the user might not feel in control of the device if he/she is not capable of stopping because, for instance, the user is afraid of the device. Indeed, current exoskeletons are not able to understand the moods, feelings and emotions of the users and, consequently, cannot adapt to the user. If the user feels afraid or needs to stop for any reason other than a system failure (but because of the willingness of the user to stop), the robotic device should incorporate a protective stop in a place that could be easily reachable for the user. This could help prevent any vandalism or any attack, as nobody could come from behind the user and stop the device without the user's permission. The Machinery directive, on the contrary, is also clear about the protective stops – it needs to be “quickly accessible”. A protective stop behind the user may need a third person to activate it. This is quite in opposition with the purpose of the exoskeleton, as it is meant to be used in ADL.

The other aspect that can clash with the autonomy of the user is when lower-limb exoskeletons include cognitive support capabilities. The EXO-LEGS project says that their exoskeleton is going to give cognitive support to the user, so to “provide information/advice to allow decision-making when the elderly person has become lost or confused”. From one side it seems that the autonomy of the person is respected because it will provide information or advice to the user. However, some simple advice may turn into an obligation if the device detects that the user is in danger. This inevitably raises autonomy questions. For instance, if exoskeletons recommend or suggest to do or not to do certain activities based on how much battery power is left, this may clash with the autonomy of the user.

The European Parliament talks about “reversibility”. It explains that reversibility is a “necessary condition of controllability, a fundamental concept when programming robots to behave safely and reliably. A reversibility model tells the robot which actions are reversible and how to reverse them. The ability to undo the last action or a sequence of actions allows users to undo undesired actions and get back to the ‘good’ stage of their work”. However, how can this be modeled in the case of exoskeletons? It is difficult to apply the reversibility principle in some cases: the velocity of the movements due to the symbiosis with the user and the fact that the exoskeleton is fastened to the body of the person, could make it impossible to reverse or undo a strange movement or an abnormal footstep.

The European Parliament also talks about the inclusion of an opt-out system when referring to the designers of the robotic technology, however, it may not be that simple when we precisely refer to lower-limb exoskeletons.

In addition, the user might feel dependent on the device to perform certain tasks, and this could affect the user's autonomy. Physical assistant robots enhance the participation in social life. Contrary to the isolation that social assistive robots could pose to users highlighted by the Robolaw project⁶⁰⁶, the symbiotic nature of the device increases the person's independent living and participation in community life. Indeed, when using physical assistant robots previous boundaries cannot any longer prevent users from socializing. This increases dramatically the dependence from the user on the robotic device. Moreover, such increase is proportional: the higher the symbiosis between the user and the device, the higher the user's dependency on it. The acquisition of this new status could create anxiety when the device does not work, frustration when the creator decides to stop producing it, etc. Despite all the data portability problems (or data protection in general), the new acquired social independent status and the anxiety that a break of the robotics device could cause to them, user's data (movement, routines, etc.) could be stored in a cloud platform and be later installed in a new device in case of breakdown.

4.6. Dignity

«One day, Francesco, returning home from the RoboGym, had one episode of confusion and disorientation. He did not know where he was or how to get back home. His exoskeleton is a Deluxe version and incorporates a navigation system. He turned it on. The system started the route in autonomous mode and took some narrow streets downtown. He was afraid»

In theory physical assistant robots should add, similar to person carriers, simple presence to the life of the users. The symbiosis characteristic of these devices however could change this ordinary simple presence; especially if the devices start incorporating cognitive support to the user. Panic situations should be avoided at all costs, even if it is not sure how the device could know if the person is in danger or not. Maybe some tracking wearable devices could help enrich this functionality but it is not sure whether this amount of sensitive data is aligned with the original idea of these exoskeletons.

Some part of the dignity of the user relates to the kind of care the user is receiving and whether that dignifies or not the person. All the users we have encountered who were using wheelchair and then tried exoskeletons felt empowered, good and they would do no-matter what to be able to train with those devices every day. Some of them are not fully convinced that these devices will be available to them to use for ADL but they were still very positive with the progress of this technology.

It is true that some of the functionalities of these robotic technology could decrease the level of human touch, as the person no longer needs the trainer to do the training sessions. The creation of the RoboGym transforms the human-robot interaction into a human-human interaction. In that sense, thanks to the creation of this gym, users of exoskeletons can now practice socially, with other people that have similar conditions. In this case, the human-human interaction is promoted. The fact that some of the users will be able to share all these experiences with other people and that there will be centers

⁶⁰⁶ Guidelines on Regulating Robotics (2014), Deliverable D 6.3 of the EU Robolaw Project, 7th Framework Program Project.

that will provide these services will actually increase social interactions. Whereas, if this technology only focuses on supporting ADL individually and not in a center with other people, then the human-human interaction would simply remain unchanged, because the exoskeleton can still provide the mobility the users lacked.

One thing needs to be clear, physical assistant robots do not intend to replace human caregivers but to help, in medical contexts for instance, therapists and users. PAR used in personal care contexts do not pose any problem in this regard. Of all the three personal care robots, physical assistant robots are the most concerned about the user. They are user-centered, even if there is no precise literature on the protection of dignity of the user.

Some authors think that the evidence for the effectiveness of socially assistive robots is limited⁶⁰⁷ while others stress that the emotional “affect generated by mechanisms within the robot’s architecture can improve the task performance of joint human-robot teams”⁶⁰⁸. Some might think that this is not what society wants (and this would be justified by the banning on healthcare robots of 65% of the interviewed population in recent Eurobarometers)⁶⁰⁹, others might think that this is in fact what society needs. In our opinion, this decision and the evaluation of the improvement in quality of life should be up to the users of these robots.

4.7. Ethics

«Pablo uses the robot daily. When he was at the RoboGym he was talking with some friends. He then turned around and found the stairs up front and the exoskeleton decided to go downstairs. A trainer wanted to help him but he did not know how to handle the situation: he never received a training to help users with exoskeletons in a Gym»

It could be argued that the ethical part derives from the ethical questions that the autonomy of these devices create when they have the power to decide what to do in a given situation; especially when this might not be aligned with the user’s intention; or, even worse, it may put the user in danger for the good of the many. Similarly to the trolley problem that could happen in person carriers, physical assistant robots will have to decide in many moments for the user. The big difference between this type of robotic device and person carriers lies on the shared task, the symbiosis of the movement.

If the person has lost the orientation and the exoskeleton provides cognitive support to him, could the robot decide to take over that given situation and help decide where to go? What could happen if the person does not agree with the robot? The ethical decisions from the exoskeleton will have to be decided by a third person, or by the user itself as we have already argued in the autonomy section. Some authorization levels, external authorizations pre or not pre-programmed could help solve this scenario. It will be unrealistic to have a person to control this and give authorizations all time. This kind of authorization in the future may even come from another technology, the so-called

⁶⁰⁷ Borenstein, J. and Arkin, R. (2016). Op. cit.

⁶⁰⁸ Scheutz, M., et al. (2006). The utility of affect expression in natural language interactions in joint human-robot tasks. In Proceedings of the 1st ACM SIGCHI/SIGART conference on Human-robot interaction (pp. 226-233). ACM.

⁶⁰⁹ See Eurobarometer 382 (2012) on Public Attitudes towards Robots. See also Eurobarometer 427 (2015) on Autonomous System

“agreement technologies”⁶¹⁰. However, how can we close the autonomous decision-making process loop? The use of cloud robotics and machine learning techniques could help avoid future unfortunate scenarios, as the robots could be learning from the experience of other robots directly. However, how can the individuality of each scenario be generalized to recreate a common pattern (like the gait pattern that the curve registration wants to do)?

The European Parliament when talking about the ethical framework mentions that it should be based on the principles of beneficence, non-maleficence and autonomy, as well as on the principles enshrined in the EU Charter of Fundamental Rights, such as human dignity and human rights, equality, justice and equity, non-discrimination and non-stigmatization, autonomy and individual responsibility, informed consent, privacy and social responsibility, and on existing ethical practices and codes. However, all these principles should be concretized depending on the technology we are talking about. For instance, when talking about discrimination, in exoskeletons this might refer to the price discrimination for the different types of exoskeletons (*see* justice section) or weight discrimination (because it is limited to people that weights under 80 kg).

Another aspect addressed in the Annex to the Draft Report of the European Parliament on its recommendations of 2016 (called “Annex to the Motion for a Resolution: Detailed Recommendations as to the Content of the Proposal Requested”) is a “charter on robotics”. Here they included (or at least it seem so) different codes of conduct for engineers, research ethics committees, designers and users. It seems to be no intention though to establish rules however for those who will be using this technology without being the primary users, i.e. the trainers of the RoboGym. In fact, and without taking into account the difference between medical device and personal care robot, there is no code of conduct for the “therapist”.

ISO 8373:2012 Robots and Robotics Devices – Vocabulary on the contrary does mention the figure of the “operator” and defines it as the “person designated to make parameter and program changes and to start, monitor and stop the intended operation of the personal care robot”. The user can be “either the operator of the personal care robot or the beneficiary of the service provided by the personal care robot”. It is not clear whether trainers of the RoboGym could be considered “operators” because exoskeletons are actuated by the estimation of movement of the user, and in theory they should not change the parameters of the exoskeletons. It is true that, if the trainer could change the parameters of the robot in order to make the class more intense for instance, then the trainers would be the operators.

In any case, if this technology is going to be widely spread and it is going to be used in gyms and in other facilities that are not 100% rehabilitation centers, a sort of update in their code of ethics should be done. For instance, the code of ethics of the American Council on Exercise read as follows⁶¹¹:

- Provide safe and effective instruction.
- Provide equal and fair treatment to all clients.
- Stay up-to-date on the latest health and fitness research and understand its practical application.
- Maintain current CPR and AED certificates and knowledge of first-aid services.

⁶¹⁰ Ossowski, S., Sierra, C., & Botti, V. (2013). Agreement Technologies: A Computing perspective. In *Agreement Technologies* (pp. 3-16). Springer Netherlands.

⁶¹¹ *See* the default message when clicking at the bottom of this site <https://www.acefitness.org/fitness-certifications/default.aspx>.

- Comply with all applicable business, employment and intellectual property laws.
- Uphold and enhance public appreciation and trust for the health and fitness industry.
- Maintain the confidentiality of all client information.
- Refer clients to more qualified health or medical professionals when appropriate.
- Establish and maintain clear professional boundaries.

After seen all the problems that all these devices will bring about in the data protection layer, safety, etc., something should be done concerning these codes of conduct; especially when the gym is going to take active part in the collection of sensitive data from their users, it will use cloud robotics techniques to download the personalized profiles of the users and will work closely with technology whose potential damages are still unknown: with the use of the robot yoga or the use of exoskeletons as general.

4.8. Justice

«Pepa decides to buy an exoskeleton to her wife. She decides not to spend a lot of money because these devices are very expensive. Within the three available models, she picks the basic model. She thinks that Wilma will like it very much. Wilma does it until the day she falls after Pepa had mopped the floor: the lower-limb exoskeleton does not include the walking-on-slippery-ground function, while the deluxe version does»

The Robolaw project uses the expression “equal opportunity” when addressing two principles that could be used for prosthetic devices. This equal opportunity has four meanings: 1) a fundamental moral right to rehabilitation; 2) a fundamental moral right to the legitimate human enhancement; 3) an opportunity shared between men and women regarding the access to and the customization of robotic prosthesis; and 4) an equilibrium with respect to policy making. However, what happens with physical assistant robots / active orthotic devices that are not prosthetics? If the system is not within the social security framework (and it is difficult to be because it is not considered a medical device, at least these type of robots), then there will be no aids in order to help buying them. This will make them inaccessible to many users. One might argue that if they were essential for the life of the users then they should be within the medical device category. The truth is that not all the devices can be included as such; not to say that there are many things that contribute to be healthy and to prevent lots of diseases, like a healthy diet, and nutritionists are not covered by the social security system.

The European Parliament is clear according to the principle of justice. A “fair distribution of the benefits associated with robotic technology” should be ensured. This could be framed by the Art. 35 of the European Charter of Fundamental Rights which contemplates the right of access to preventive health care. This is what the EXO-LEGS project tries to do when mentioning that their devices will be “affordable via a suitable business model” which include different systems like renting, leasing, multi-person use (like in the RoboGym), prescription, etc. However, one question arises: how could something not meant for non-medical purposes be prescribed within the medical social security system? Maybe the extension of the medical device protection helps in this

regard. However, if exoskeletons need to be compliant with the medical device regulation, this is going to increase directly the costs. However, how can ExoKools be multi-person use if they are just for people with height ranging between 160 and 190 cm and with a weight less than 80kg? Would the dimensions of a device cause discrimination?

The EXO-LEGS project also has proposed a revolutionary concept, that is, to create different exoskeletons with different prices and characteristics: the basic, the standard and the deluxe version. It could be argued nonetheless that the correlation between price/category and safety requirements is not ethical. If we take a look at Fig. 11 again, we will find that the basic exoskeleton version does not have a walking-on-slippery-ground function or a walking on ramps, or navigation support system. This is what actually happens in already established companies. ReWalk website states that “The new ReWalk Personal 6.0 System is designed for all day use at home and in the community. It is the most customizable exoskeleton and is configured specifically for you. This precise fit optimizes safety, function and joint alignment”. Nobody has still written on the relationship between the price and the safety of the user. A minimum safety should be provided equally, yet an exoskeleton that is cheaper might not include the walking-on-slippery-ground function. It seems that the ISO 13482:2014 establishes a minimum of requirements. Yet, reality is very different and whether safeguards like a walking-on-slippery-ground function should be compulsory is an open issue.

It has been argued that 3D printers could help users’ access to technology. For physical assistant robots, this could also be the case. The users could print themselves these devices as they have already been printed from EksoBionics. The impact of 3D printing is still unknown though. The problem of the European Union funding schema is the fact that it is pushing for a marketable product. EU funds projects that end up with a product that can be marketed. If the users however get the knowledge and the design examples and they can print by themselves, how is this money going to go back? Some may argue that there are already some limitations on the 3D printing: it is slow, expensive, unreliable, you cannot do all the shapes, geometry problems, etc. However, the exponential growth function as well as other examples that we have already seen (price decrease in technology like TVs, DVD...) make us confident to say that in the future 3D printing will be vastly available to the home of the users and that, among other things, will raise several questions on the personal care level⁶¹².

5. Summary of physical assistant robots analysis

All the above-mentioned risks and solutions can be grouped and presented in a practical chart. This chart can be useful to roboticists to understand long juridical discussions; and also to jurists to understand what and how some of the requirements can be translated into technical terms. This list is complementary to the one of the person carrier robot chart. If there is some information concerning those devices that is also applicable here, then it will need to be applied.

Current PAR may not probably require a complex regulatory framework, like the one social assistive robots need, but there is urgent need to fill this legal gap. Their crucial challenges are based on safety, liability, independence, privacy and autonomy.

⁶¹² To know more how 3D printing could change the world, *see* Campbell, T., Williams, C., Ivanova, O., & Garrett, B. (2011). Could 3D printing change the world. Technologies, Potential, and Implications of Additive Manufacturing, Atlantic Council, Washington, DC. *See also* Birchnell, T., & Urry, J. (2016). A New Industrial Future?: 3D Printing and the Reconfiguring of Production, Distribution, and Consumption. Routledge.

Our analysis shows that a precise regulation to govern legal and ethical aspects of PAR (even if soft-law) is of vital importance. Some guidelines regarding legal and ethical solutions are provided here but there is still a long way to understand the concrete legal/ethical risks of PAR.

Engineers agree with the need for standardized evaluation criteria and that clear effectiveness and safety evaluation are missing⁶¹³. It is also true that there are some hardware/software failures that are inevitable and that cause a legal uncertainty. Quantitative data is needed in order to understand the real problems with PAR. Next-generation PAR might include some assistive capabilities that will for sure have a direct impact on the legal layer. In fact, the symbiosis in the execution of the movement will lead us to confuse PAR, robotic prostheses, or robotic organs. This will pose several ethical questions. For instance, it will be necessary to clarify whether PAR will be considered part of the human body and treated as equal as human parts (for indemnification reasons in case of harm).

task-oriented
user-oriented
social interaction

CONTEXT	
Risks	Recommendations
Place	Specific requirements for different types of public/private institutions
	Specific requirement for the type of architecture/environment: cloud, IoT.
Users	Specific requirements: special attention to elderly, children and disabled people
Robot	CRIA should be developed for each robot the institution has
	Different safeguards depending on the technology applied to it, the robot's capabilities and the HRI
	Clarity on the type of robot and the regulation that applies to it
	Mixing categories: addressing different robots
CRIA	Identify the internal/external stakeholders

SAFETY	
Risks	Recommendations
Estimation Movement	Use User Intent Recognition Systems through natural interfaces
	Avoid delays when natural cognitive processes are encoded into an imposed sequence of tasks

⁶¹³ Tucker et al. op cit.

		Consider whether estimating the movement from an already general gait pattern, previously analyzed, can make UIR faster
		Address pitfalls in general gait patterns
		Consider to estimate the movement through physical interaction with the environment and the device; or by manual inputs like keypads, buttons or joysticks, voice commands, or eye movements. Address slow feedback and error connection
		If Brain Computer Interface is preferred, remember to balance the maximization of the collected information with the minimization of the invasion of the used instruments. Electromyography is preferred even if non-stationary and has a cyclic nature
		Address misunderstandings on UIR
		Electromechanical delay between the motor commands and the generation of force is a source of instability, as well as it is the time between transitions, especially in lower-limb orthosis. Roboticians need to work towards making it 100% reliable.
		Consider lowering the over-power level of the device (implying that the user can overpower the device) in case of less than 100% reliability
		For the time delay between transitions, an automated pattern recognition system could be incorporated into the device
		Machine learning could help to reach better accuracy in mode recognition. Consider using Big Data to manage all possible risk scenarios
		Avoid monopoly of data and ask for the pertinent consent of the users
Execution of the movement	General	In lower-limb devices (e.g. exoskeletons), especial attention should drawn to the risk of falling, slipping and collision/tripping when performing the movement
		Risks concerning unsafe/invalid motions, that is, if the exoskeleton moves exceeding the range of motion of the wearer are also crucially important
	Obstacle-related risks	Obstacles can pose a risk to normal gait (e.g. stairs, objects, etc.). ISO 13482:2014 states that collision with safety-related objects, with other robots, with “fragile” safety-related objects, with walls, permanent/unmovable barriers are not applicable to restraint-type physical assistant robo. However, if PAR include a navigation system these aspects will have to be taken into account
		For those obstacles that impede normal gait, several sensors could be added to the device.

		A Terrain Recognition System (TRS) could also help avoid obstacles
		To manage the increase inputs of these sensors, a cloud platform could be considered to lighten the weight of the robot and speed up the process
	Environmental related risks	Environmental-related accidents from the external viewpoint, are the first cause for falls in elderly
		Comply with ISO 13482:2014 environmental hazards: high level of dust, sand, exposure to snow, ice, water or saline atmosphere
		Design the robot in such a way that foreseeable environmental conditions during the intended use do not lead to hazards, for instance: apply dust-resistant materials, seal electrical components, or even other additional protective measures like including a forced ventilation, dust detection, air filters
		the producer shall include some information for the users like the duty for inspection, cleaning for the prevention of sand/dust/snow/ice, drying and the maintenance and replacement of the parts
	Balance	balance can be at risk due to environmental conditions, due to the encountering of an unexpected terrain, but also for the transition switching; and this can provoke a fatality for the user
		Consider applying a motion control algorithm for exoskeleton push recovery in the frontal plane to ensure stability during the gate life-cycle
		Incorporate safety balance algorithms similar to the zero-moment point (ZMP) which could help get user trust. This is especially important for those exoskeletons that incorporate a special shoe with them and that help the user perform the movement from the feet to the hip and that have a degree of autonomy
		It is found that, logically, most of the problems concerning stability disappear when walking at a higher pace. Balance between running and elderly people.
	Falling	Declaration of the fall: when two legs are not on the floor
		Add communication capabilities when a fall is detected to ensure assistance is provided
		A wearable airbag could be used in order to enhance safety
		If the exoskeleton has the ability to detect a fall, then the built-in sensor block or the exoskeleton itself can tell to the airbag to inflate

		The inclusion of a protective stop should help reduce any possible fall. This should be placed in a place close and reachable for the user, not in his/her back.
	User Intrinsic Risks	They can be physical, for instance, the user coughs, sneezes, or has an uncontrolled spasm; or they can be cognitive, the user feels afraid to use the device
		The user needs to feel secure with the device during all gait cycle
		Allow a “spiral of adaptation”, meaning that the user needs to get used to the device
		In the lack of guidelines on how this spiral of adaptation might be, there is the strong recommendation to implement a driving test prior the delivery of the robot as well as to train trainers on them
		Roboticians will take special consideration to the emotional and psychological effects because they are important.
		Special attention to a cognitive aspect: the acquisition of a new status could create anxiety when the device does not work, frustration when the creator decides to stop producing it
		Cosmesis will be addressed to offer comfort of use in all senses. 3D printing techniques can help achieving the customization of the devices.
		Instability
	the device should be very low-powered so that it cannot harm the user	
	incorporate a warning sound to indicate that its position is not the appropriate one	
	reduce (in case of moving in this face) the speed to a safety-related speed/force control	
	Unexpected terrains can happen and can be undetectable by the robot. The speed on which the robot falls and the way is destabilized makes impossible the algorithm to overcome	
	Providing feedback to the user as reassurance that the device has correctly identified the next intended movement could help to correct balance	
	Brain activity to provide high-level commands to the device could be very useful to further on execute the movement	
	the removal of the exoskeleton will lead this device to be in “safe state”	
Others	Body size	The company will provide adjustable length on exoskeletons

	Models	There will be no safety-related difference between different sizes or models
Cloud Robotics		Ensure that the safety of the user is provided if the parameters are transferred from one device to another one.
		Ensure compatibility of the systems
USER PROTECTION		
	Risks	Recommendations
perceived safety		Take into account the user's perception of the level of danger when interacting with a robot
		Take into account the user's level of comfort during the interaction
		Being afraid of the device, for instance, not only constraints the perfect performance of the device, beyond other side-effect problems, i.e. heartbeat accelerates, hands sweat. This should be mitigated
		The user is permitted to make use of a robot without risk or fear of physical or psychological harm
		Write guidelines on how to model these cognitive aspects within the design of the product
		Incorporate balance algorithms to promote better safety perception
Environmental risks		Produce eco-robots without carcinogenic products
		Reduction on the use of plastics
cognitive exoskeleton		Correct categorization of robot and appropriate safeguards
certified safety		Compliance with the medical device regulation (future extension of the regulation)
LIABILITY		
	Risks	Recommendations
Prospective Liability	General	As powered active devices might be capable of generating destructive forces whose controlled output behavior may not always be aligned with the user's intent, it is important to provide a three-fold safety layer: environment, device and user.
		There is the possibility that a robot might cause harm in the future
Prospective Liability	General	Roboticians should allow patients to provide appropriate and reliable feedback to the physicians from the very beginning, either through their experience or through mechanisms that provide that information (muscle sensor information)
		More qualitative and quantitative data at this respect is needed in order to know the likelihood of occurrence and whether some extra safeguards should be implemented or not. Inertial sensors could help provide this information.

Cognitive harm	Attention should be made to prevent physical assistant robots from causing any emotional harm in the legal domain due to frustration, depression, dependency or even the cosmesis of the device
Trainer Responsibility	Make certain that the "responsibility of the teacher" of the European Parliament does not include the trainers teaching in classes with this rehabilitation robotics.
BYOD	Clear rules on bring-your-own-device initiatives
Cloud Robotics	Clear rules on how can the use of cloud robotics be implemented properly (because of different devices/requirements)
	Model data portability to avoid liability
USER RIGHTS	
Risks	Recommendations
Proxemics	The symbiotic movement of physical assistant robots, as well as the fact that most of them are fastened to the human body (restraint type), have canceled the applicability of proxemics in this case.
Bodily Privacy	Bodily privacy and the invasiveness to his own personal internal space is of crucial importance
Personal data	Physical assistant robots need to track the movements of the patient, control them, and monitor its use as well as to actuate in accordance to it in real time
	Protection to those who want their data to be processed and to those who do not, should be guaranteed
Biomedical data	Biomedical data needs to be protected
	All the data that concerning the performance needs to be used, which is highly variable and depend either on internal factors, such as the age, the mental state of the person, the physical strength that the person has, or any pathology that indirectly is affecting his gait; or external-to-the-person factors like the quality of the surface, the lightning, etc
Curve of Registration	Consider Curve of Registration: The curve registration requires the study of various human gait aspects in different persons in order to determine the walking patterns from the users, that could be normalized. From the ones that could be normalized, an optimal gait pattern could be generated. These normalized gait patterns could be a good starting reference trajectories for the design of exoskeleton controllers, and later be able to adapt to individual gait patterns.

	This would lead to the collection of incredible amounts of data from a lot of people that only through big data techniques this could be possible. Appropriate collection of data and consent from the users should be provided
Companies using data	The use of personal data from companies that have already sold their devices to the users should be limited if they don't match with the original consent
	It should be ensured that there are no abusive clauses in the contract concerning the use of data
	A dynamic consent form should be preferred
	Data protection authorities should be more active on monitoring companies using these data
	Companies should be aware that the anonymisation of data does not involve per se the loss of the "personal" feature of data.
Data	Thee collection and processing of personal sensitive data needs to be balanced against other compelling interests (such as the protection of a person, the invasion of privacy)
	Unequivocal informed consent of the user is needed
	Data collected and processed needs have to be proportionate (for the intended task/the purpose which motivated the processing).
	In 2018, the data controller should carry out an impact assessment on the impact of the processing of these data to the data subjects and apply the pertinent remedies
house-hold exemption	The household exemption would not apply because all data is transferred to many different people (e.g. manufacturers, trainers at the gym, etc.) and not for household activities
Right to be Forgotten	Make sure that the forgetting parameters that some of these devices include is enough compliance with the future right to be forgotten or not.
Data Ownership	It should be clear who is the owner of the data
Data portability	The creator of the robot needs to ensure the data portability right of the user (while minimizing at the same time the data security scarcities of it).
AUTONOMY	
Risks	Recommendations
General	A balance between the autonomy of the user and the autonomy of the robot should be established so that the robot that the user cannot overpower accomplishes tasks the user did not agree with.

Robot Perspective	The user in the physical assistant robot does not perform this task alone: it is a shared task performed jointly between the human and the robot. This symbiosis implies a physical empathy with the user's movement
	In the cases where the robot cannot be overpowered by the user, safety should be ensured even at a greater level than those that the user can overpower, as the gait will lie then on the device's power and not on the user
	appropriate safeguards should be implemented if there are cognitive-support modes on the device that could involve the decision-making process of the user.
Control check	implementation of human control check to impede certain decisions taken by the robotic system that could affect the person's life or integrity should be implemented
	There should be modeled how can this control check be done in certain scenarios (the banana peel that provokes the robot to fall).
Protective stop	The protective stop should be placed in a reachable space for the user to safely stop. This could help prevent any vandalism or any attack meaning that nobody could come behind the user and stop it without the user allowing to do so, as well as promote the autonomy of the user on deciding when can the system be stopped
User perspective	Avoid the user to not feel in control of the device if the user cannot stop the device
	Special attention to the cognitive support that will provide information/advice to allow decision-making when the elderly person has become lost or confused
	A system that could explain the risks that would imply the use of the device behind the recommendation of the robot could be a way to avoid responsibility from the creator perspective and also to enhance the autonomy of the user
Reversibility	If the concept of reversibility is binding, it should be modelled in the case of exoskeletons
Opt-out	Model an opt-out system in the case of lower-limb physical assistant robots
Cognitive aspect	Special attention to a cognitive aspect: the acquisition of a new status could create anxiety when the device do not work, frustration when the creator decides to stop producing it
DIGNITY	
Risks	Recommendations
user-centered	Physical assistant robots should be user-centered at all the stances

	The personalization of the devices can improve acceptance, trust and dignity
decrease human-human interaction	Attention should be drawn to the decrease of human-human interaction
	The creation of specific centers of training (not only rehabilitation) may promote the human-human interaction
Invisibility	The system should be designed to reach a certain level of invisibility, either in the literal sense (that could be worn under the garment), either in the movement (unnoticeable by others)
ETHICS	
Risks	Recommendations
Third control check	The ethical decisions from the exoskeleton will have to be decided by a third person, or by the person itself
	Some authorization levels, external authorizations pre or not pre-programmed could help solve this scenario
	If a third person cannot be monitoring all the time the decisions made by an exoskeleton, this third person in the future might be another technology (ie agreement technologies)
Cloud Robotics	The use of cloud robotics and machine learning techniques could help avoid future unfortunate scenarios, as the robots could be learning from the experience of other robots directly; although then the individuality of the cases should be applied to the new concrete scenario
Ethics	The ethical framework mentions that it should be based on the principles of beneficence, non-maleficence and autonomy, as well as on the principles enshrined in the EU Charter of Fundamental Rights human dignity and human rights, equality, justice and equity, non-discrimination and non-stigmatization, autonomy and individual responsibility, informed consent, privacy and social responsibility, and on existing ethical practices and codes
Institution Code of Ethics	Upgrade of the ethical codes of the institution according the new given robotic situation would be recommendable.
Justice	
Risks	Recommendations
Access	Equal opportunity
	It should be ensured a fair distribution of the benefits associated with robotic technology

	Devices should be affordable via a suitable business model which could include different systems like renting, leasing, multi-person use or prescription
	Provide the users with different sizes of exoskeletons
	Provide the users with different prices for different types of exoskeletons with the same amount of safety.
Justice	Low-cost technology to enhance equal access
	Aids and grants for those in need
Discrimination	Dimensions of the device cannot cause discrimination scenarios

Table 9 Possible list of engineering controls for lower-limb exoskeletons (sub-type physical assistant robots)

4. Chapter - Analysis of Social Personal Care Robots: Mobile Servants

"We have much more to learn and a lot to gain from understanding our ethical shortcomings. When it comes to building a physical world, we seem to understand our limitations. We build things like roads and bridges to help us with these things that we can't do perfectly on our own. But when it comes to the mental world, we somehow forget the idea that we are limited, that we are fallable. Science have some starting points to help us think about this. It's not going to be simple, but we all have the capacity to build a better more ethical, more honest world"

Prof. Dan Ariely
(Dis)Honesty: The Truth About Lies

1. Mobile Servant Robots: Socially Assistive Robots

This section will be about one specific type of mobile servant robot: "social assistive robots" (SAR). The Climbing and Walking Robots Association Ltd. (CLAWAR) announced the release of ISO 13482:2014⁶¹⁴, they included including Care-O-Bot3⁶¹⁵, REEMC⁶¹⁶, ASIMO⁶¹⁷ and Roomba⁶¹⁸ under the category of mobile servant robots. The actual definition of mobile servant robots is "personal care robot that is capable of travelling to perform serving tasks in interaction with humans, such as handling objects or exchanging information". Considering this definition, Roomba might not be under the category the standard is referring to⁶¹⁹. The description of mobile servant robots and their related tasks in Annex I of the standard focus more on SAR. SAR is basically service robot technology that can perform useful tasks for humans, support multimodal interactions⁶²⁰ and can have in general positive effects if

⁶¹⁴ See <https://clawar.org>

⁶¹⁵ See the robot from Franhofer at <http://www.care-o-bot.de/en/care-o-bot-3.html> which also includes the 4 model at <http://www.care-o-bot-4.de>

⁶¹⁶ Meet REEMC from PAL Robotics at <http://pal-robotics.com/es/products/reem-c/> a robotics company based in Barcelona which we visited during summer 2014

⁶¹⁷ This is the most classical robot from Honda, Asimo. Meet it at <http://world.honda.com/ASIMO/>

⁶¹⁸ This is the most famous vacuum cleaner in the world, from iRobot, Roomba: <http://www.irobot.com/For-the-Home/Vacuumping/Roomba.aspx>. Among other projects, the founders of this project have been working on military robots too, as stated by Singer, P. W. (2009). *Wired for war: The robotics revolution and conflict in the 21st century*. Penguin; and as we can see in <http://www.irobot.com/About-iRobot/Company-Information/History.aspx>

⁶¹⁹ Gurvinder Virk himself explained me that they want to include Roomba as a mobile servant robot. The truth is that in the standard though they did not include in the standard any sub-category such as "cleaning robots". Although the human robot interaction might be higher due to the fact that it is used by non-experts and it works in non defined environments, which would make the robot a "service robot", first, it is not as higher as with any other Hoover (although yes it has the autonomy component and is actually a robot) it does not really meet the essential characteristics of the definition which are "exchanging information or handling objects".

⁶²⁰ Welch, K. C., et al. (2010). An approach to the design of socially acceptable robots for children with autism spectrum disorders. *International Journal of Social Robotics*, 2, 391–403

deployed carefully⁶²¹, either in elderly or in children care⁶²².

Annex I reports that: “Mobile Servant Robots in domestic environments (...) Travelling in domestic environments (...) while avoiding collision with stationary and moving safety-related objects (...) interaction with humans including object exchange. The robot can have an active or passive role. Handling small and medium-size objects (e.g. coffee cup, plate, book) including grasping, manipulating, transporting, placing and handling over the object. Handling large objects possibly having constraints, e.g. opening a door, window, a drawer, a dishwasher, which might include travelling in order to extend the workspace” (see Fig. 1). Vacuum cleaners do not perform these tasks⁶²³. SARs do it, and have been primarily used in elderly care not being yet considered medical devices. In fact, most of them do not perform tasks concerning the medical device regulation.

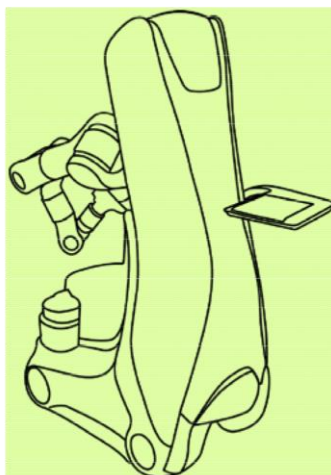

Figure 40 Mobile Servant Robot as shown in ISO 13482:2014, Annex D.

Mobile servant robots have also been used in other applications, like in education contexts. For instance, Fig. 2 shows a picture of Tico, a mobile servant robot that has been largely used in educational contexts, in marketing and in retail⁶²⁴. Tico helps the teacher in resolving mathematics tests with the students and it is proved that students feel more engaged and motivated when using the robot. PARO, the seal robot, and Fisiobot, a physiotherapeutic robot are two other robots worth mentioning in terms of robotic therapy.

⁶²¹ Sharkey, A. (2014). Robots and human dignity: a consideration of the effects of robot care on the dignity of older people. *Ethics and Information Technology*, 16(1), 63-75

⁶²² Reiser, U. et al. (2013). Care-O-bot 3 Vision of a robot butler. *Your virtual butler*, 97-11

⁶²³ Although these are just examples of functional tasks to be performed by these robots, as the Annex I says, the fact that the ISO did not have any other example on it and focused all the attention in these tasks makes us believe that their intentions were clear when they did not provide any other example.

⁶²⁴ In their website, one can read a simulated description made by the robot “I am a really versatile robot, with a great capacity for learning and adaption. My strongest point is the interaction with people, I’ve worked in different areas like Education, Marketing and Advertising and Retail. I am very affable and I have the ability to attract people, especially with children”. See www.adelerobots.com/en/tico/

ISO 13482:2014 does not provide any sub-category for mobile servant robots but differentiates between mobile servant robots that are “small AND light weight AND slow AND no manipulator” and those that are “large OR not light weight OR fast OR with manipulator”. According to it, in this section we will describe a robot that is large AND no light weight AND slow AND with manipulator. The context of use of the robot will not be education but the delivery of care.

There has been a lot of research on whether robots could be used to improve the quality of care⁶²⁵. Improving the quality of care, however, could have multiple meanings, and ISO 13482:2014 does help in clarifying this aspect⁶²⁶. Indeed, neither the definition of personal care robot nor the negative taxonomy of the standard (excluding robots travelling faster than 20 km/h; robot toys; water-borne robots and flying robots; industrial robots, which are covered in ISO 10218; robots as medical devices; military or public force application robots; as well as space robots) actually explain what “personal care” is.

Although a precise definition is still lacking, different research groups are analyzing whether the use of robots in elderly care can actually improve the quality of care. There is still no comprehensive evidence for this, probably because the number of commercially available robots and the related quantitative and qualitative research are limited⁶²⁷. In fact, the research on this topic is scattered in many research centers, with many different robots, that perform great variety of tasks. Thus, it is very difficult to find some common features. Furthermore, recent studies are focused on the use of robots in therapeutic contexts but it is not clear whether these robots need to be categorized as robot toys or medical devices⁶²⁸, or if



Figure 41 Tico from Adele Robots, in Asturias, Spain. Own picture.

⁶²⁵ See Tapus, A., Mataric, M. J., & Scassellati, B. (2007). Socially assistive robotics. *IEEE Robotics and Automation Magazine*, 14(1), 35; Feil-Seifer, D., & Mataric, M. J. (2011). Socially assistive robotics. *IEEE Robotics & Automation Magazine*, 18(1), 24-31; Torta, E., Oberzaucher, J., Werner, F., Cuijpers, R. H., & Juola, J. F. (2012). Attitudes towards socially assistive robots in intelligent homes: results from laboratory studies and field trials. *Journal of Human-Robot Interaction*, 1(2), 76-99; Bonaccorsi, M., Fiorini, L., Cavallo, F., Saffiotti, A., & Dario, P. (2016). A Cloud Robotics Solution to Improve Social Assistive Robots for Active and Healthy Aging. *International Journal of Social Robotics*, 1-16, among others.

⁶²⁶ For more information, see Villaronga, E. F. (2016). ISO 13482: 2014 and Its Confusing Categories. Building a Bridge Between Law and Robotics. In *New Trends in Medical and Service Robots* (pp. 31-44). Springer International Publishing.

⁶²⁷ See Bemelmans, R., Gelderblom, G. J., Jonker, P., & De Witte, L. (2012). Socially assistive robots in elderly care: A systematic review into effects and effectiveness. *Journal of the American Medical Directors Association*, 13(2), 114-120.

⁶²⁸ Albo-Canals, J. (2015) op. cit.

they are mobile servant robots used in therapeutic contexts⁶²⁹.

This section will not be about social robots that can be used in therapy (*see future steps section*)⁶³⁰, but it will describe social assistive robots that help elderly with their ADL. These robots are likely to be marketed soon as they help the elderly to stay at home longer, which is crucial to reduce healthcare costs. Empirical evidence suggests that informal care can reduce the need for nursing home care and this can have a considerable implication on taxation and policy making⁶³¹. Whether mobile servant robots are considered part of informal care is yet an unanswered question. In 2005 Charles and Sevak investigated the relationship between home care and nursing home care, and found that several factors come to play when a person decides to go to a nursing home. For instance, his/her main income, or marital status. Costs are also a central element. In fact, these researchers suggested that subsidizing the cost of informal care could promote a longer stay at home since humans are getting older in healthier conditions (although not everyone might agree with this statement⁶³²). Clearly, there are both advantages and disadvantages of home care⁶³³:

- Advantages: home offers comfort, stability, peace of mind, flexibility; it is less costly than going to a nursing home, and allows the person to have pets.
- Disadvantages: caregivers are not there 24/7, the delivery of care depends on the persons who is responsible for taking care of the elderly (family, informal caregivers, availability in the area), which affects directly the quality of the received care (as there is no authority controlling them): lack of back-up person, no assured quality, no responsibility, etc.

The job of social assistive robots is to help with all the drawbacks of home care. Mobile servant robots offer the possibility to be around 24/7, to do checks around the house and control that the elderly are ok, to call the ambulance, doctor or relatives in case of emergency. They provide companionship to elderly people, they can be helpers in many tasks, they can remind the elderly to take the pills; they can also do the shopping for the elderly and people can interact with the care-receiver through the robot tele-operating it.

As A. Rodić suggests, the level of care, the attention given to the users, the type of mental communication and of emotional contact provided by the robot is of paramount importance⁶³⁴. That is why this sub-type of personal care robots are considered “social

⁶²⁹ Fosch-Villaronga, E., and Albo-Canals, J. (2015). Boundaries in Play-based Cloud-companion-mediated Robotic Therapies: From Deception to Privacy Concerns. In *Conference Proceedings New Friends 2015* (Vol. 164, No. 6, pp. 597-600).

⁶³⁰ During my Ph.D. I had the opportunity to visit two nursing homes using therapeutic robots. First, I went to CASTA Salud in Asturias, Spain . There I met with Ana Belén de Juan Muñozerro, the psychologist from the center. They were involved in a project with 12 elders and the seal robot PARO. Another center was The Instituto de Robótica para la Dependencia, Ave Maria Foundation in Sitges, Barcelona, Spain . They are specialized in adults with intellectual disabilities attention. They are working with different robotic technologies in order to improve their quality of life. In that precise moment is where I realized that the Human-Robot Interaction was different, it was not happening on the physical level, but on the cognitive one.

⁶³¹ Charles, K. K., & Sevak, P. (2005). Can family caregiving substitute for nursing home care?. *Journal of health economics*, 24(6), 1174-1190.

⁶³² Klein, H. G. (2003). Getting older is not necessarily getting better. *The Journal of the American Society of Anesthesiologists*, 98(4), 807-808.

⁶³³ See For more information *see* www.which.co.uk/elderly-care/housing-options/home-care-support-services-and-help-at-home/342899-the-benefits-and-drawbacks-of-home-care-services and also *see* <http://www.ukhca.co.uk/aboutus.aspx>

⁶³⁴ A. Rodić et al. (2016) op. cit.

robots”; beyond the fact that they move, or they are embodied (as Darling suggests), they interact with humans on the cognitive layer, they respond socially, they offer a two-way interaction, they express or understand thoughts or feelings, they are socially aware, they interact unpredictably or spontaneously, and they provide the feeling of companionship or of mutual respect⁶³⁵. What we do not know yet is whether this is what humans want for the future of care and which safeguards should be applied.

Current machinery-type standards governing service robots focus on the physical human-robot interaction. However, they seem inadequate for social robots that are used in elderly care that work primarily on the cognitive layer; which is in fact a problem if the legal regulatory system protects both the physical and the mental integrity of the persons. There is a need for a concrete and holistic definition of mobile service robots and personal care, and some clarification is also essential regarding the new emerging ISO/IEC robot categories (especially between boundaries and gaps in machinery with medical device regulations), liability scenarios (could there be non-physical harm?), avoiding harm, prospective liability, butterfly effect. A better definition and regulation of human-robot collaborations and relationships, ethical issues (mass surveillance, post-monitoring personal data), autonomy (from the robot but also from the user perspective), isolation scenarios, etc., are also necessary. Despite the recent technical advances, there is still a long way ahead and further research is needed to overcome a variety of associated legal and ethical issues which are emerging.

Although there are no current specific laws to regulate these robots, users are a vulnerable part of the society. They obviously need prompt and special protection, which is not provided by the current standards.

2. Context

In this analysis, social assistive robots aim to help users stay more time at home without needing a nursing home. Therefore, the context of use is the user’s home. Although Kramer and Scheutz conducted a thorough survey in 2006 on the development of environments for autonomous mobile robots⁶³⁶, they focused on the architecture development for mobile robots but did not provide information about the “environment” understood as the physical surroundings in which a robot operates.

The use of social robots at home might challenge the creator of the robot: in fact, they cannot know beforehand how the user’s house will look like, and how the robot will be able to learn how to move around without colliding with objects, moving pets or other humans in the house. There are different types of houses (some with stairs, some without; some with four bedrooms, some are just a studio). They are, in theory, unstructured environments (*see below*)⁶³⁷. The house that we present in this context is a *smart house* inspired by the work of A. Rodić⁶³⁸ and the Cueing Kitchen at the Human Engineering Research Laboratories (HERL) from the University of

⁶³⁵ These are the aspects that have been raised in a experiment conducted by some researchers at University of Twente. *See* Graaf, M. M. A., et al. (2015). *Op. cit.*

⁶³⁶ Kramer, J., & Scheutz, M. (2007). Development environments for autonomous mobile robots: A survey. *Autonomous Robots*, 22(2), 101-132.

⁶³⁷ What we will argue later on is that in order to work efficiently, all these technologies need to be integrated into a structured environment, so it will not be 100% true the fact that they are *unstructured* environments.

⁶³⁸ A. Rodić et al. (2016) *op. cit.*

Pittsburgh⁶³⁹. Both projects introduce a smart domestic environment in order to help users with their ADL. There is a difference between these two projects: whereas HERL only focuses on a smart kitchen capable of helping the user with several tasks, Rodić introduces a physical robot that will help the user carry out several tasks in a smart house with wireless sensors networks which will include, among others, wearable devices capable of monitoring the user's vital signs. The context of this section, therefore, is going to be a "robotic system" which will include a smart home, a physical robot and wearable devices worn by the person. Our context is the following one⁶⁴⁰:

«John is getting old. His husband left him after their trip to Cuba, where he fell in love with a younger Cuban guy. John's memory is not as good as it used to be and to clean the house has never been his thing. His house, little by little, becomes very untidy and disorganized. Dirty clothes on the floor, dishes to clean, dust everywhere. His doctor tells John to pay attention to his diet too. John is alone. He has two sons: Albert, who visits him once every month; and Charles, a son that lives in Africa. Albert, the closest son that was aware of the situation, decided to provide his father with a personal care robot. The robot would help John with the cooking, the washing and would remind him to take medication at appropriate times. Furthermore, the robot could keep an eye on him, make him company, and encourage him to change his diet habits. To take fully advantage of the robot and the system, the house needs some upgrades. After one week with housework, the house and the robot are ready to take care of John»

Although our focus is the mobile servant robot, it is important to know that the more and more robots will be a "thing" within the internet of things (IoT), meaning that, in the end, the robots will be communicating with other devices around the house and will be integrated with the rest of the systems. As we have seen in other robots, environmental sensing provides an additional layer of safety⁶⁴¹, and lightens the weight of the robot because the sensors do not have to be embedded to it (the robot only has to have access to them)⁶⁴². Furthermore, it is a complementary protective measure established by ISO 13482:2014⁶⁴³. In this context, the fact that the house is a restricted scenario (not an open context like in the case of person carriers), the activities within the house can be studied more carefully.

A home, to be smart, needs to integrate a variety of autonomous sub-systems. In other words, "instead of individual devices working independently, a smart home integrates multiple sub-systems that are all controlled by a master home automation

⁶³⁹ We visited the center while we were finishing our program in Pittsburgh, PA, US. For more information of the project see <http://www.herl.pitt.edu/research/cueing-kitchen> for the center itself, have a look to: <http://www.herl.pitt.edu>

⁶⁴⁰ This scenario is inspired in part by the movie *Robot&Frank* from 2012 directed by J. Schreier and written by C. Ford.

⁶⁴¹ As in other projects has been highlighted, see J. M. Souza et al. (2014) op. cit., see Bian, N., Gamulescu, C., & Haas, T. (2010). Fusion of vehicle and environmental sensing. *ATZ worldwide*, 112(9), 18-22.

⁶⁴² As Rodić et al. (2016) op. cit. says, "each activity of the robot requires certain activities of the environment. This activity of the environment is primarily there to help the robot and relieve him of additional sensors and complex algorithm".

⁶⁴³ See the section 5.10.3.3.

controller”⁶⁴⁴. These sub-systems typically include lighting, blinds, heating, ventilation and air conditioning, security, irrigation and entertainment; also latest technologies could be included: for instance, washer and dryer that run quieter when you are at home or only work when the electricity is low-cost, a heater that turns off when you are not at home, etc.⁶⁴⁵.

The Cueing kitchen at HERL is a normal kitchen that has been upgraded with low-cost wireless sensors and technologies that are ready to use (cueing technologies) and they do not need significant modification (*see* Fig. 55).



Figure 42 Cueing Kitchen at Herl. Own Picture.

If the person wants to cook pasta, for instance, the system would guide the user accordingly: first, it will indicate where the pot is located (by illuminating the handles), then the system will tell the user to fill it with water (the tap will close if the user forgets to close it), then it will ask the user to boil it, and so on. The system guides the user “timely and in a systematic manner” and it adapts its instructions depending on the user’s cognitive abilities. A smartphone can remotely control the oven, the stove or the faucet⁶⁴⁶.

In order to provide an efficient assistance, however, it is not enough to adapt the physical environment with low-cost sensors or including a robot. In the words of Rodić et al. “it is necessary to set up an information structured environment to enhance

⁶⁴⁴ Cedia (2012) What is a Smart Home? The Basics of Home Automation. Visited in July 2016. *See* <http://www.cedia.org/blog/what-is-a-smart-home-the-basics-of-home-automation>. CEDIA is a leading authority on home technology industry. Visit also Brain of Things, another company working on these technologies at <http://brainofthings.com>.

⁶⁴⁵ All these characteristics can be found in NEST by Google, *see* <https://nest.com/works-with-nest/>.

⁶⁴⁶ Extracted and adapted from the website of HERL, <http://www.herl.pitt.edu>

benefits of different technologies to be applied”. This is very important because although houses are unstructured environments, they still need to be somehow “structured” in order to allow these technologies work efficiently. In fact, all the cabinets have to have RFID markers, the shelves need to have sensors in order to know whether they contain all the objects they are supposed to have, and the robot needs to have a map of the house or a path planning feature to build the map of the house (although glass walls and other objects might be very tricky to be planned, *see* safety section). We are certainly still far from having a robot that arrives home and is capable of doing anything the user tells it to do – with no further help of other technologies.

«The apartment of John is a studio. When the workers went to his place they removed all the existing walls, except from the one in the bathroom, because that was the easiest way to implement all the systems that would help the robot perform its tasks. They included all the needed sensors and established all the architecture for them to work»

A plan of the smart home can be found in fig. 4. The smart house includes inertial sensors for movable furniture, but also motion sensors in order to detect if someone is inside the house or not or in a particular place; pressure sensors under the bed and under the chairs measure whether a person is sitting down or lying down. There is also a floor tracking system in order to know if the person has fallen down, as well as RFID tags in order to know whether all the objects are inside the different cabinets.

Next section will introduce the social assistive robot that will be deployed in John’s house.

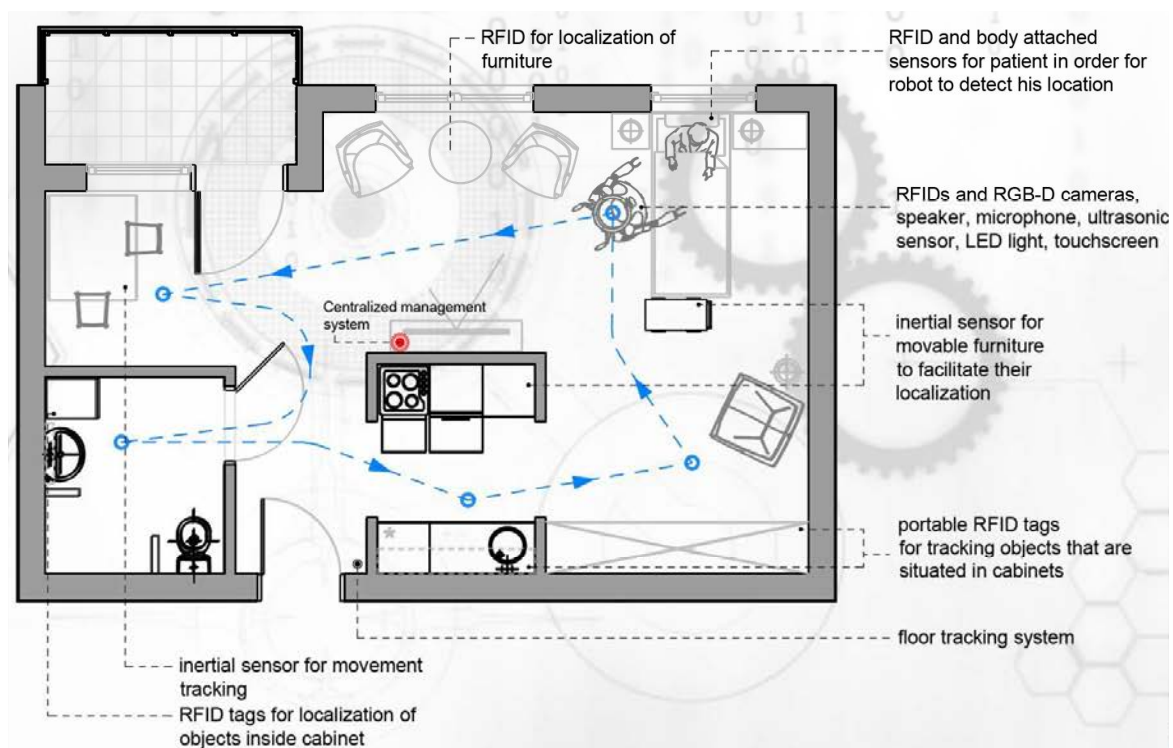

3. Robot type: Socially Assistive Robot

This section introduces a mobile servant robot from the Medical and Service Robots International Workshop (MESROB) in Nantes, France⁶⁴⁷. The Institute Mihajlo Pupin from Belgrade, Serbia, introduced a mobile servant robot and described it as a “human-centric, social, care-robot for elderly people and persons with reduced ability to improve the quality of their life and to create conditions for more independent living at their homes [...] by providing companionship”⁶⁴⁸. This robot needs to complement its features with ambient assisted living technologies (AAL) and wearable body devices for the humans that can measure, among others, the user’s blood pressure, heart pulse and motion accelerations.

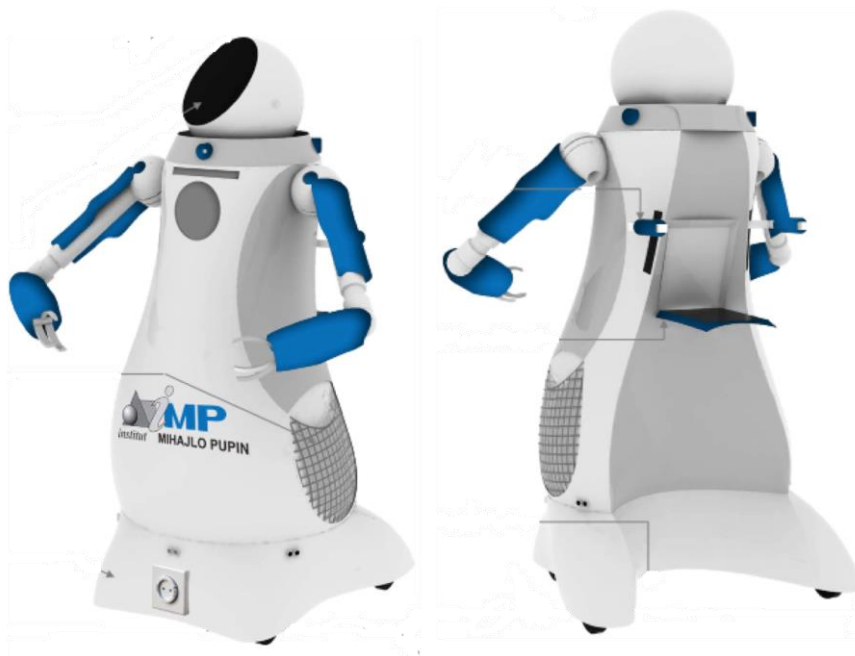

Figure 44 Institute Mihajlo Pupin’s Robot from Belgrade, Serbia.

The embodiment of the robot plays a crucial role in social robot’s acceptance, because it affects users’ perceptions of the robot’s personality, mind and intention⁶⁴⁹. Person carriers and physical assistant robots do not have this, because they do not interact with mobile servant robots in a social manner. In addition, they are not already

⁶⁴⁷ For more information, have a look to their website <http://mesrob2015.irccyn.ec-nantes.fr> and see the book they published Wenger, P., Chevallereau, C., Pisla, D., Bleuler, H., & Rodić, A. (2016). *New Trends in Medical and Service Robots*. Springer.

⁶⁴⁸ A. Rodic et al. (2016) Op. cit.

⁶⁴⁹ See E. Broadbent, et al. (2013) Robots with Display Screens: A Robot with a More Humanlike Face Display Is Perceived To Have More Mind and a Better Personality. *PloS one*, 8(8). See also Mutlu B., et al., (2009) Footing In Human-Robot Conversations: How Robots Might Shape Participant Roles Using Gaze Cues. *ACM/IEEE HRI*, pp. 61-68

well accepted in society, differently from person carriers. Physical assistant robots are meant to help the user with an essential task, walking, therefore wheelchair users are very prone to use and accept them. On the contrary, mobile servant robots might be use the embodiment to gain acceptance, as now an external entity that it is not a human will be performing tasks that typically were conducted by a human. That has great impact on its acceptance. That is why the embodiment of it is crucial: the robot needs to avoid any clash with any Hollywood connection that the person might have (normally towards killing robots) and needs to promote the idea that the robot is a helper, a good caregiver⁶⁵⁰.

Among all the existing possibilities (zoomorphic, anthropomorphic, non-biomimetic), the Mihaljo Pupin Institute robot is a “monolithic entity with amorphous shape”, in other words, the robot has not a clearly defined shape, although it has a head and two arms with graspers which makes it more similar to a human (See figure 5).

As the robot moves, and performs tasks, the robot might seem alive. The lifelikeness of a robot has a strong role in HRI, especially if it is designed to work at the emotional level⁶⁵¹. Moreover, the more robots will become social, the more people will probably build close and reliable relationship with them⁶⁵², especially if they are inside their personal environment. This is because robots are physical, can behave autonomously, and they have a social behavior – which lead humans to respond to cues even if they are not alive⁶⁵³. Therefore, it is important to address social awareness aspects (*see infra*)⁶⁵⁴, and also cultural differences, as failing to do so could raise serious ethical issues and rejection.

3.1. Description of the Robotic system and applications

The robot of Mihaljo Pupin is a socially assistive robot that is born to perform several of the tasks that a caregiver would do, such as assisting the user with ADL (picking things from the fridge and warming them up in the microwave; bringing a glass of water to the user; calling a friend through Skype, do groceries shopping online, etc.), tasks related to nursing (coordinate care among different healthcare professionals; administer medication), monitoring activities (observing and recording the users’ behaviors and body gestures, keep an eye on the users’ to call emergency services in case of falling), amusement activities (typically from companionship like playing a game with the user, telling a story, etc.) or communicating with the users (exchanging information, talking to them, coaching, counseling, etc.). The robot is prepared to be used by the user connecting him/her to the internet, social network sites; and it is also prepared to receive tele-visits from the doctor and other healthcare professionals. The

⁶⁵⁰ Later on we will dig in the idea that robots need to be trustworthy thanks to the work of Salem (2015) et al. op. cit.

⁶⁵¹ De Graaf, M and Ben, S. (2016) The Influence of Prior Expectations of a Robot’s Lifelikeness on Users’ Intentions to Treat a Zoomorphic Robot as a Companion,” *International Journal of Social Robotics*.

⁶⁵² Leite, I. et al. (2013), Social Robots for Long-Term Interaction : A Survey, *International Journal of Social Robotics*, pp. 291–308

⁶⁵³ Darling, K. (2016) op. cit.

⁶⁵⁴ To know more about cultural differences in acceptance of robots *see* Broadbent, E., Stafford, R., & MacDonald, B. (2009). Acceptance of healthcare robots for the older population: review and future directions. *International Journal of Social Robotics*, 1(4), 319-330; Kaplan, F. (2004). Who is afraid of the humanoid? Investigating cultural differences in the acceptance of robots. *International journal of humanoid robotics*, 1(03), 465-480 or also Bartneck, C., Suzuki, T., Kanda, T., & Nomura, T. (2007). The influence of people’s culture and prior experiences with Aibo on their attitude towards robots. *Ai & Society*, 21(1-2), 217-230 for a more specific example with the dog Aibo. At this regard, the video of the New York Times on the acceptance of Aibo is very interesting, *see* <http://www.nytimes.com/video/technology/10000003746796/the-family-dog.html>

robot can be remotely controlled in order to help the user grasp objects in certain cases⁶⁵⁵.

The robot can do all these activities because its ergonomic characteristics and its connection to all the sensors allow good mobility around the house⁶⁵⁶. The robot can also provide cognitive support to users that, contrary to the support given by physical assistant robots, is also psychological. An artificial intelligence system embedded to the robot that contains emotional intelligence modules as well as different personality profiles makes the communication capabilities of this robot much more interesting than other robots with a pre-programmed behavior.

The robot has two handles on its back (*see* Fig. 5 on the right) so that the user can use the mobile servant robot as a physical assistant restraint-free type. ISO 13482:2014 included powered walking aids as restraint-free physical assistant robots. Again, this is one living example of the mixing categories existing in this realm of personal care robots.

3.2. Characteristics of the Robotic system and applications

The robotic system of Mihaljo Pupin can be divided into three different levels (*see* Fig. 6):

1. The physical level includes the user with the wearable devices attached to him/her, the robot itself, the objects around the house (cabinets, armchairs, couches, bed, etc.), and the sensors in the environment (inside the cabinets, under the sofa/bed, etc.);
2. The network level allows wireless and fast communication between the different agents involved in the robotic system;
3. The application level, which includes a cloud system that collects, processes and stores the information about the different applications, sensors and patient. According to A. Rodić, the collected information includes data about the physical and psychological condition of the user (*see* user's right section). The cloud system allows a fast communication between the agents. Decision-making process can be done in real time thanks to it.

⁶⁵⁵ This has been added thanks to several conversations we had with Andrea Sundaram at HERL around the inclusion of a robotic arm into a wheelchair (similar to the CMU project, but a bit different). Through this section we will mention some of the things we highlighted in our conversation when we visited HERL different from what we highlighted in chapter 3 A.

⁶⁵⁶ According to the ISO 13482:2014 the robot shall conform the ergonomics standards appropriate to its intended purposes and mentions the ISO-TR 9241-100, ISO 9241-210, ISO 9241-400, ISO 9241-920 and ISO 11228.

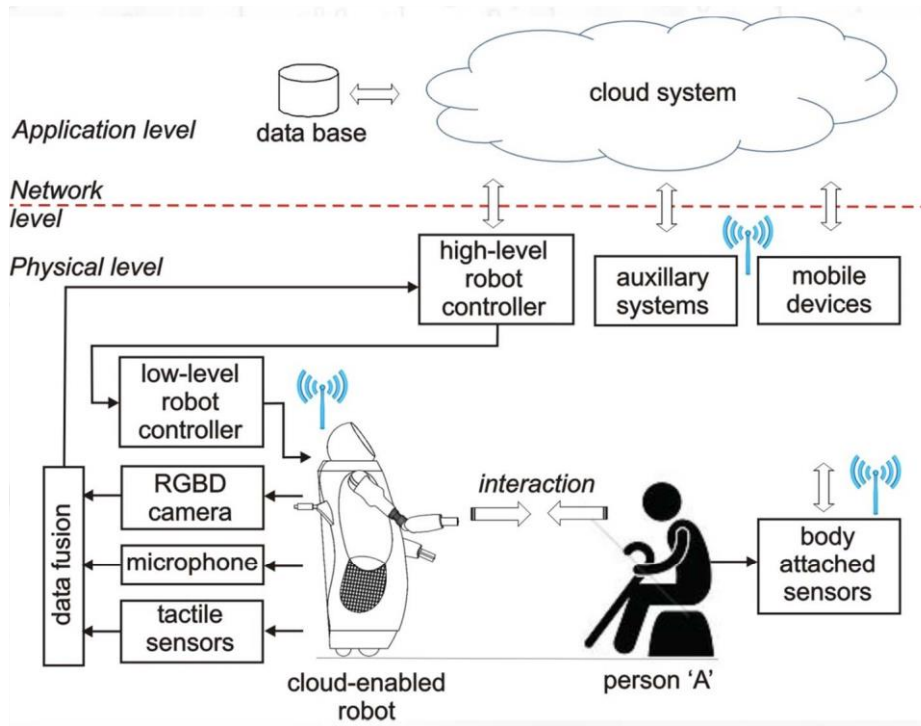

Figure 45 Three-level of the Robotic System. Extracted from A. Rodić et al. op. cit.

As we have already described the context, i.e. the smart home, we will now introduce some of the characteristics of the robot (*see fig 7*)⁶⁵⁷ and the wearable devices attached to the body of the user:

- A) Characteristics of the Robot: The robot is primarily divided in two parts, the head and the body:
- a. The head of the robot includes a kinematic mechanism with one degree of freedom (DOF)⁶⁵⁸ which allows it to rotate around vertical axes, a touch screen that displays information but that works as an interface for the user commands, three microphones, and a visual depth sensor. Based on light and sound inputs, the head of the robot can be rotated upon their direction.
 - b. The body of the robot is wider on the lower part because it incorporates two industrial-quality lightweight arms which would, otherwise, exceed the length of the robot. The body of the robot cannot rotate on its axis, but the two arms have 6 DOF and incorporate a gripper. Situated on the lower part of the robot's body, there are two pockets made of an elastic net in order to provide ventilation to the carry-on items, e.g. fruits and vegetables. Ultrasonic sensors are placed around lower part of the body.

⁶⁵⁷ These characteristics have been extracted by the work of A. Rodić.

⁶⁵⁸ For those not familiar with the terminology, a degree of freedom is a number of independent motions that are allowed in the mechanism (or the pieces of the system). In this case, only one.

B) Wearable devices. Wearable technology differs from the previously described cases. It consists of miniature body-borne computational and sensory devices that steadily collect information about the wearer. It differs from other types of mobile technology (e.g. smartphones or tablets) because it is not, or only rarely, handheld. As the Human-Computer Interaction Encyclopedia explains, wearable computers may be worn under, over or in clothing or may also be themselves clothes⁶⁵⁹; and they are capable of collecting a wide range of information from the user's body (e.g. health status, habits or mood) and environment (e.g., images, temperature, location, sounds or even third parties' personal data)⁶⁶⁰. Article 29 Working Party (A29WP) has defined them as "quantified self"⁶⁶¹. Among the four main segments in wearable technology, in this section we will only address healthcare and medical wearables⁶⁶².

Based on several analyses, digital wearable health has the potential of being a double-win strategy for both the private and the public sector⁶⁶³. Market predictions expect this technological trend to grow significantly over the next few years⁶⁶⁴. In the work of Rodić et al. there is not much information about wearable devices, but some examples of successful integrations of wearable technology into healthcare are: continuous glucose monitors (e.g. an artificial pancreas)⁶⁶⁵, glucose contact lenses⁶⁶⁶, heart remote monitors⁶⁶⁷, sleep measurers and improvers⁶⁶⁸, Alzheimer's sufferers helpers⁶⁶⁹ or wearables for Parkinson disease⁶⁷⁰.

Although examples of the benefits of this technology are countless, it is still not clear whether these devices also provide a winning situation for the user, because to be more accurate they need to collect more and sensible information about the user. Indeed, the collection of massive quantity of data clashes directly with the principle of data minimization enshrined in the data protection regulations. This raises lots of other legal issues ranging from the consent of the users, the ownership of the collected data, the protection of non-personal data, the loss of control over it and the future use and unknown market value of it. Special attention is needed because the objective of these sensors is to extract information about the activities of the user: what is the mood of the

⁶⁵⁹ Mann, S. (2012) Wearable Computing. In: Soegaard, M., & Dam, R. F. (2012). The Encyclopedia of Human-Computer Interaction. The Encyclopedia of Human-Computer Interaction. Available at: <https://www.interaction-design.org/literature/book/the-encyclopedia-of-human-computer-interaction-2nd-ed>

⁶⁶⁰ Opinion 02/2013 on Apps on Smart Devices. Article 29 Working Party. Available at: http://ec.europa.eu/justice/data-protection/article-29/documentation/opinion-recommendation/files/2013/wp202_en.pdf

⁶⁶¹ Opinion 8/2014 on the on Recent Developments on the Internet of Things, Article 29 Working Party. Available at: http://ec.europa.eu/justice/data-protection/article-29/documentation/opinion-recommendation/files/2014/wp223_en.pdf

⁶⁶² Market Research Reports Biz. (2013) Wearable Technology Market - Global Scenario, Trends, Industry Analysis, Size, Share And Forecast, 2012 – 2018. Available at: <http://www.marketresearchreports.biz/analysis-details/wearable-technology-market-global-scenario-trends-industry-analysis-size-share-and-forecast-2012-2018>

⁶⁶³ See <http://www.wearable.com/wearable50/best-wearable-tech>

⁶⁶⁴ Beckland, R. (2015) The Digital Health Trends Poised to Transform Healthcare in 2015. Validic, available at: <https://validic.com/wp-content/uploads/2015/04/2015-Digital-Health-Trends.pdf>

⁶⁶⁵ See more information at: pancreum.com/index.html

⁶⁶⁶ Look to the patent US 9,158,133 B1 of Google concerning "Contact lenses employing optical signals for power and/or communication".

⁶⁶⁷ See more information at: www.preventivesolutions.com/technologies/body-guardian-heart.html

⁶⁶⁸ See <https://kokoon.io>

⁶⁶⁹ See <http://www.liftware.com>

⁶⁷⁰ See <http://glneurotech.com/kinesia/products/kinesia-360/pd-wearables-apps/>

person, if the user is anxious or not, if the person sleeps at night, etc. (see user's rights safeguard section).

(1)

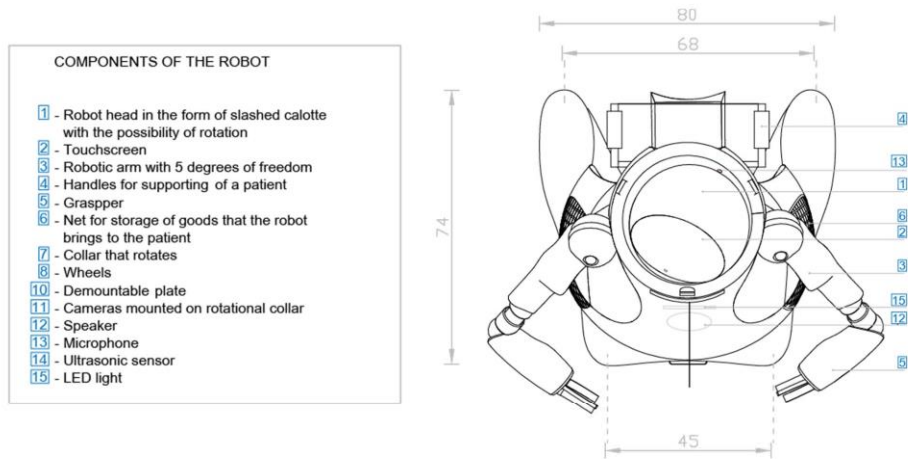

(2)

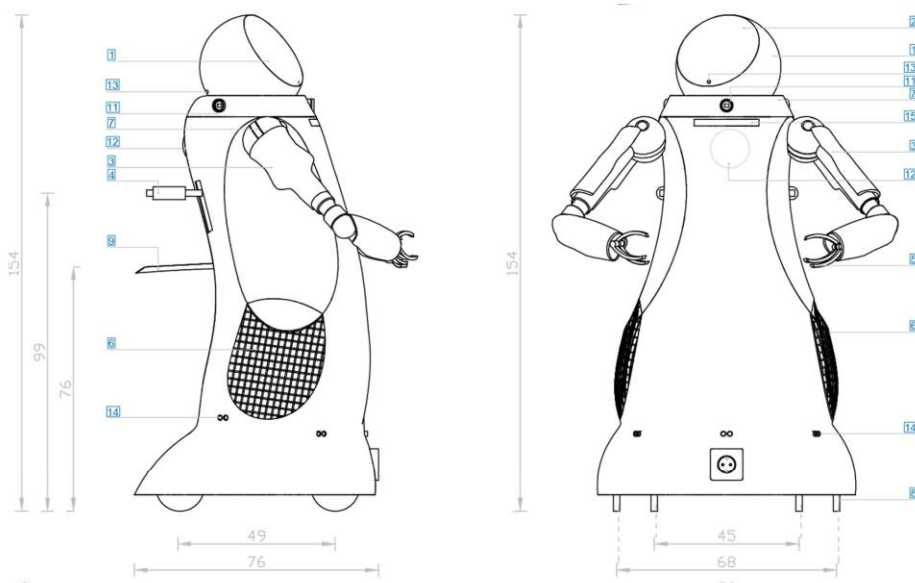

Figure 46 Components of the robot (1) and (2). Rodić et al. op. cit.

Mobile servant robots differ largely from person carrier and physical assistant robots because there is practically no physical contact in their HRI. The exchange of information does not involve passive or active physical human robot interaction and can be done orally or using body language. Mobile servant robots issues, will lie on

understanding human's commands and will depend on the type of interaction these will have with the user: sporadic or long-term relationship. Some mobile servant robots in airports or museums have sporadic, very limited, and very focused on a particular HRI⁶⁷¹.

Other mobile servant robots will be in personal environments and will work for/with elderly or disabled people. These robots are commonly known as socially assistive robots (SAR; also called "Companion Robots", "Carebots" or "Care Robots" by the general population) will be the result of the evolution of simple MSR "as they will not only communicate but play a role in user's emotional life"⁶⁷². SAR are designed to interact and communicate with humans in a naturalistic way by using biological communication channels, not really in a physical way with humans⁶⁷³. The interaction is on a cognitive level, people that interact with them tend to respond in a similar way they would respond to other human beings⁶⁷⁴.

4. Risk Scenarios

5.1. Safety

«John is not very convinced with the robot that Albert has brought him. John has the impression that the robot is controlling his movements and that Albert has an agreement with the doctor in order to force him to take the pills against his will. He is even suspicious about his ex wife controlling the robot to take revenge because he left her for another man.»

Traditionally only industrial robot standards and regulations were available for ensuring human safety via ISO 10218-1, -2. These regulations were concerned mainly with ensuring human safety by separating humans from operational robotics (normally by caging the robot outside of the human workspace). Recently, a standard for service robots has been published (the one we are addressing here: ISO 13482:2014). The new service robot regulations focus on physical HRI hazards by stipulating safety requirements on various design factors, including: robot shape, robot motion, energy supply and storage or incorrect autonomous decisions⁶⁷⁵. However, the state of the art confirms that robot capabilities go beyond the mere physical HRI, especially if the robot is used in social applications⁶⁷⁶.

Although mobile servant robots perform tasks "in interaction with humans" (as stated in ISO 13482:2014), they differ from person carriers and physical assistant robots because there is no "zero-distance" between the human and the robot on the exchange

⁶⁷¹ See the SPENCER project coordinated by the University of Twente www.utwente.nl/ctit/research/research_projects/international/fp7-streps/spencer/

⁶⁷² Collins, E. C. et al. (2015) op. cit.

⁶⁷³ Ibidem.

⁶⁷⁴ Lee, K. et al. (2005) Can a Robot Be Perceived as a Developing Creature? Effects of a Robot's Long-term Cognitive Developments on its Social Presence and People's Social Responses towards it. *Human Communication Research* 31, pp. 538-563

⁶⁷⁵ Of note, the incorrect autonomous decisions part of the standard only states "a personal care robot that is designed to make autonomous decisions and actions shall be designed to ensure that wrong decisions and incorrect actions do not cause an unacceptable risk of harm", however, there is not a breakdown on what are the acceptable and the non-acceptable risks or who is to decide on the acceptability of those.

⁶⁷⁶ Robinson, H. et al. (2014). The role of healthcare robots for older people at home: A review. *International Journal of Social Robotics*, 6(4), pp. 575-591

of information or the handleability of objects (tasks typically from mobile servant robots as stated by ISO 13482:2014). Indeed, handling objects includes grasping, manipulating, and placing objects; and exchanging information can be done orally or using body language, but there is not much physical HRI involved. Thus, questions concerning other hazards such as cognitive HRI hazards, robot personality, emotional intelligence and HRI, understanding human commands, isolation scenarios, the acceptable level of autonomy in the robot decision-making process (in legal transactions on the Internet for instance, which its consequences could not physically harm a human) or simply the respect for private life are not fully covered by these service standards. However, “ignorance of the law, excuses not” is a clear and factual statement, which must be addressed to ensure there is clarity in these uncertain times.

As a matter of fact, challenges concerning suicidal requests, feeling of intimidation (provoked by the robot) or robot’s self-assertion cannot be dealt uniquely with physical safeguards. And this is of highly importance as the respect for the physical and psychological integrity of the person is a recognized fundamental right in the European Charter of Fundamental Rights (EU CFR). Indeed, “Human dignity – both physical and psychological – is always to be respected”⁶⁷⁷. The recommendations of the European Parliament on the use of robotic technology states that users will have the right to make use of a robot without risk or fear of physical or psychological harm. Yet, it should be clarified which safety standards regulate the psychological HRI.

The main objective of this section is to highlight growing wider concerns in adopting service robots in new settings and to provide some guidelines for the creation of a possible future regulatory framework for mobile servant robots, which includes legal and ethical aspects⁶⁷⁸. ISO 13482:2014 reports the relevant hazards related to mobile servant robots.

In the Annex A, there are sets of hazards that can relate to personal care robots. Although all might apply to personal care robots depending on a case-by-case basis, there are some which are more specific to mobile servant robots. As the users of the robot might have some visual and hearing impairment, the lack of awareness hazard concerning silent operations becomes more important in this case. Although the robot might make noise, this noise should be modeled according to the personal needs of the user (possibility to rise the volume for instance). This could be combined with the robotic system; for instance, some lights in the house could be lit if the robot is approaching, or the bed could be vibrating if that should be the case and the person would not feel afraid (a part from the hazardous vibration levels stated also in the ISO).

The Cueing Kitchen from HERL has a so-called “cognitive advanced dialog generation software” that generates and adapts instructions to users depending on their cognitive abilities. There are no guidelines on how this adaptation should be done, if the adaptation is done randomly or if it should be aligned with some already well-known tests such as the Folstein Test [also called mini-mental state examination (MMSE)] or the Bristol Activities of the Daily Living Scale (BADLS) which both measure the degree of cognitive impairment of the demented subjects sensitive to

⁶⁷⁷ See 2015/2103(INL) European Parliament Resolution with recommendations to the European Commission on Civil Law Rules on Robotics (May, 2016)

⁶⁷⁸ Salvini, P. (2015) *op. cit.*

change⁶⁷⁹. If guidelines adapted to the level of impairment were available, then the roboticists could adapt their systems and interface accordingly⁶⁸⁰.

The Mihaljo Pupin robot will not probably be involved in the “poor visibility of personal care robot” hazard as its dimensions are largely equivalent to the size of a human being (*see* Fig. 60 to compare it).



Figure 47 Mobile servant robot size and avoidance of the “poor visibility” hazard

Concerning the environmental hazards, ISO states that if a robot is going to be working in a kitchen (heating up meals or preparing some basic meals), in a personal environment or if it is operated for long periods of time between the maintenance inspections, then special attention should be drawn to the high level of dust. If the robot is not intended to be working outside, then other environmental hazards might not really apply. However, as the robot has the possibility to work as a robotic assistive aid, the user might be interested in having a walk with him in an outdoor context. In this case, it will be relevant that the robot is also capable of traveling in exposure of snow, ice or other environmental conditions. In any case, the robot needs to be able to learn from the environment (*see* below).

The “extreme temperatures” hazard relates to the temperature of the robot. However, independently of incorporating a cooling or a heating system, in mobile servant robots this hazard might look different. As the robot will be in the kitchen, it is important that the robot is prepared to touch hot surfaces (the stove) or cold surfaces (the freezer) with its robotic arms. Whether it is not clear what are the standards that these arms should comply with (because they are “industrial-quality” robotic arms), it is surely important that the robot is ready to pick a hot plate from the microwave without burning itself and not hurting the user. For instance, if the plate that comes out of the microwave is very hot, the robot should be capable of warning the user by any

⁶⁷⁹ This is the big difference between these scales and the Cleveland Scale of Activities of the Daily Living. For more information, *see* Bucks, R. S., Ashworth, D. L., Wilcock, G. K., & Siegfried, K. (1996). Assessment of activities of daily living in dementia: development of the Bristol Activities of Daily Living Scale. *Age and ageing*, 25(2), 113-120.

⁶⁸⁰ Arianna Rossi is a colleague of our PhD Erasmus Mundus Last-JD, and she is addressing the possibility to transmit the legal knowledge on comics format. If that could work for impaired people too, then this could be the system that could be used for this cognitive adaptation.

means, and leave the plate in a place where it cannot hurt the user, e.g. on the table (not giving it to him).

If the robot user incorporates medical implants or devices, it is important that SAR does not emit harmful levels of electromagnetic interference. On the contrary, all the hazards concerning posture and usage hazards will not apply in this case, as the physical HRI is practically non-existent (beyond the fact when the robot is used as a walking aid device). What will be crucial, however, is to improve the design of the user interface, as the robot will be commanded not only by voice commands but also through the screen of the robot. The information should be adapted according to the end-user's needs otherwise the usability might be at risk⁶⁸¹. This should be done in a way that the user does not feel discomforted because he/she does not understand the robot. This is of crucial importance as this could lead to some mental strains scenarios, which already happened with industrial co-bots⁶⁸².

Some hazards due to robot motion are of particular interest for mobile servant robots. For instance, the robot of Mihaljo Pupin can work both as a mobile servant robot and as a restraint-free physical assistant robot. If it incorporated a base in order to transport the user (as in the work of Lee and Jung⁶⁸³), this criterion should be taken into account. Special attention to the following robot motion hazards are necessary: travel instability, instability in collision, instability while carrying objects (in the pockets of the robot for instance), or detachment of the body parts after collision. ISO 13482:2014 promotes the design of the stability of the personal care robot to ensure that it does not fall, rollover or overturn "within the intended environmental conditions specified for the robot". In the physical assistant robot chapter, we mentioned already the case of the banana peel and the dog robot from Boston: not only environmental conditions can constrain the performance of the device, but also sudden and unpredictable cases like the broken glass example in A. Rodić, or this banana peel can have an effect. The robot should be programmed in a way that is able to detect all these aspects in order not to fall, but also to protect the user from harming himself.

The robot motion can lead to some collisions and collisions could lead to physical harm. We have already spoken largely about object avoidance in person carriers. When being in personal environments, object avoidance will be much more important, as the safety-related space is more limited compared with open environments. This is basically because the objects in a house are closer⁶⁸⁴. In the Mihaljo Pupin robot this consideration gains importance. This is because the robot is said to "contain(s) ultrasonic sensors placed around lower part of the body". However, ISO 13482:2014 clearly states that contact sensing is required for HRI tasks and that contact "shall be detected along the entire robot structure". If researchers fail to do so, not only the certification would not be given (so they could not show the compliance for the "certified safety") but, and even worse, the safety of the user could be at risk.

As people have a stronger reaction when robots invade their personal space as compared with humans⁶⁸⁵, robot motion will have to be studied from the proxemics

⁶⁸¹ Granata, C., Pino, M., Legouverneur, G., Vidal, J. S., Bidaud, P., & Rigaud, A. S. (2013). Robot services for elderly with cognitive impairment: testing usability of graphical user interfaces. *Technology and Health Care*, 21(3), 217-231.

⁶⁸² Arai, T., Kato, R., & Fujita, M. (2010). Assessment of operator stress induced by robot collaboration in assembly. *CIRP Annals-Manufacturing Technology*, 59(1), 5-8.

⁶⁸³ Lee, H. J., & Jung, S. (2010). Op. cit.

⁶⁸⁴ Tamura Y, Fukuzawa T, Asama H (2010) Smooth collision avoidance in human-robot coexisting environment. In: IEEE/RSJ inter-national conference on intelligent robots and systems, pp 3887– 3892

⁶⁸⁵ Joosse, M. et al (2013) BEHAVE-II: The Revised Set of Measures to Assess Users' Attitudinal and Behavioral Responses to a Social Robot, *Int J Soc Robotics* 5:379–388

perspective, that is, to address the appropriate negotiation of personal and shared space between the human and the robot⁶⁸⁶. This is normally done in a way to protect the user, not only from causing him/her a physical harm but also in order not to invade the privacy of the user. As proxemics is based on environment and on cultural aspects, this is going to be of special importance in social robots because cultural aspects need to be taken into account when designing the HRI⁶⁸⁷.

Some aspects concerning HRI are still not fully covered by the ISO 134982:2014, such as starting a conversation⁶⁸⁸ and maintaining it⁶⁸⁹. As the robot imitates the ways humans interact with other humans, robots will have to know basic social norms of humans⁶⁹⁰. According to the European Parliament, the designer of the robot should ensure that his/her robot operates in a way that is in accordance with local, national and international ethical and legal principles. That is why Rios-Martinez talked about “social awareness”, which he defines as “A socially-aware navigation is the strategy exhibited by a social robot which identifies and follows social conventions (in terms of management of space) in order to preserve a comfortable interaction with humans”⁶⁹¹. If the robot designer could apply some team mental models to the robot⁶⁹², the resulting behavior could be predictable, adaptable and easily understood by humans. The designers of the robot, indeed, will need to make the robot in a way that its behavior is legible by the user, regardless of the user’s degree of impairment⁶⁹³; they will have to ensure that robots are identifiable as robots when interacting with humans (contrary to the definition of Smart that we gave at the beginning of this thesis)⁶⁹⁴.

Social robots are designed to interact and communicate with humans “usually, in a naturalistic way by using biological communication channels”⁶⁹⁵. In fact, people that

⁶⁸⁶ Koay K.L. et al (2014), Social Roles and Baseline Proxemic Preferences for a Domestic Service Robot, *Int J of Soc Robotics* 6:469–488

⁶⁸⁷ Walters, M. L., Dautenhahn, K., Te Boekhorst, R., Koay, K. L., Syrdal, D. S., & Nehaniv, C. L. (2009). An empirical framework for human-robot proxemics. *Proc of new frontiers in human-robot interaction*. Joosse, M. et al. (2014). Lost in proxemics: spatial behavior for cross-cultural HRI. In *HRI 2014 Workshop on Culture-Aware Robotics*. See also Hall ET (1966) *The hidden dimension: man’s use of space in public and private*. The Bodley Head Ltd, London

⁶⁸⁸ Satake, S., Kanda, T., Glas, D. F., Imai, M., Ishiguro, H., & Hagita, N. (2009, March). How to approach humans?—strategies for social robots to initiate interaction. In *Human-Robot Interaction (HRI), 2009 4th ACM/IEEE International Conference on* (pp. 109–116). IEEE.

⁶⁸⁹ Michalowski M, Sabanovic S, Simmons R (2006) A spatial model of engagement for a social robot. In: 9th IEEE international work-shop on advanced motion control, pp 762–767

⁶⁹⁰ Bartneck C, Forlizzi J (2004) A design-centred framework for social human-robot interaction. In: IEEE International workshop on robot and human interactive communication., pp 591–594. See also Ge SS (2007) *Social robotics: integrating advances in engineering and computer science*. In: 4th annual international conference organized by Electrical Engineering/Electronics, Computer, Telecommunication and Information Technology (ECTI) Association

⁶⁹¹ Rios-Martinez J et al (2015) From Proxemics Theory to Socially-Aware Navigation: A Survey, *Int J of Soc Robotics* 7:137–153

⁶⁹² Scheutz, M. (2013, July). Computational mechanisms for mental models in human-robot interaction. In *International Conference on Virtual, Augmented and Mixed Reality* (pp. 304–312). Springer Berlin Heidelberg. The importance of the vision of Scheutz is that in the context of teams, what matters is to establish a common ground and the construction of a team mental model (not explaining various types of human reasoning).

⁶⁹³ Kruse T, Basili P, Glasauer S, Kirsch A (2012) Legible robot navigation in the proximity of moving humans. In: *Workshop on advanced robotics and its social Impacts*, pp 83–88

⁶⁹⁴ Resolution European Parliament op. cit. According to Richards and Smart said that the robot should “appear” to the user as a robot, when the European Parliament promotes the idea that the designers/creators will have to be sure that they are identified as robots. See Richards, N. M., & Smart, W. D. (2016) op. cit.

⁶⁹⁵ Collins, E. C. et al. (2015) Saying it with Light: A Pilot Study of Affective Communication Using the MIRO Robot. In Wilson, S.P. et al. (2015) *Living Machines*, LNAI 9222, pp. 243–255. See also Takayama L, Pantofaru C (2009) Influences on proxemic behaviors in human-robot interaction. In: IEEE/RSJ international conference on intelligent robots and system.

interact with them tend to respond in a similar way they respond to other people⁶⁹⁶. This makes a difference between person carriers, physical assistant and mobile servant robots: whereas the scope of non-social assistive technology is to interact physically with their users to detect motion intention and execute a movement [either sporadically (PCaR) or in a symbiotic manner (PAR)] with practically no communication involved, social robots focus on communicating with the user at a higher level, apart from performing assistive tasks such as transporting objects or opening doors. In fact, there are some researchers that believe that “they (mobile servant robots) will not only communicate but play a role in their user’s emotional life”⁶⁹⁷. Because of that, it will not only be crucial to know how the robot should approximate the human physically, but also cognitively, in social terms. There are currently no guidelines on this topic even if experts in the field have expressed their concerns at various conferences.

The major problem social roboticists face right now is that they do not know actually what other safeguards – apart from the standards – should be implemented into their systems. Although there is much research on HRI from the psychology and the cognitive science perspective, there has been no great effort from the legal community to address these cognitive aspects, neither in Europe or in the United States. Some initiatives to ethically design robots and robotic systems have been recently released in the United Kingdom⁶⁹⁸. However, while these machinery safety regulations are being developed, supra-/national and state laws are needed to provide citizens a fully legal coverage, not only in privacy matters⁶⁹⁹ (see user’s rights safeguard section). This is of crucial importance especially because the European Parliament stated “Robot designers should consider and respect people’s physical wellbeing, safety, health and rights. A robotics engineer must preserve human wellbeing, while also respecting human rights, and disclose promptly factors that might endanger the public or the environment.” If a future regulation does not take into account these other cognitive aspects, then we might come up with a regulation that could not provide the citizens and users with a fully legal coverage, as their rights also include psychological safety.

Concerning cognitive safety issues, social assistive technologies need to take into account another fundamental aspect, to “demonstrate that they are trustworthy”⁷⁰⁰. The sporadic HRI in mobile servant robots, e.g. exchanging information in a corridor in a hospital or in a convention center, or reminding elderly people to take medication at certain times, is increasingly turning into a “life-long relationship” once the robot will end up in personal environments (see *infra*)⁷⁰¹. According to Salem et al., trust plays a central role in this type of technology because the user needs to accept the commands provided by the robot. This is directly linked to acceptance. In the case scenario, John does not trust in the robot and, most likely, he will end up not following its commands, as he does not think the robot is his helper but, on the contrary, a form of conspiracy plan made by his ex-wife.

⁶⁹⁶ Lee, K. et al. (2005) Can a Robot Be Perceived as a Developing Creature? Effects of a Robot’s Long-term Cognitive Developments on its Social Presence and People’s Social Responses towards it. *Human Communication Research* 31, pp. 538-563

⁶⁹⁷ Collins, E. C. et al. (2015) op. cit.

⁶⁹⁸ BS 8611 Robots and robotic devices — Guide to the ethical design and application of robots and robotic systems. See: standardsdevelopment.bsigroup.com/Home/Project/201500218

⁶⁹⁹ Wang, Y. and Kobsa, A. (2008) Privacy Enhancing Technologies. In: M. Gupta and R. Sharman, eds. (2008) *Handbook of Research on Social and Organizational Liabilities in Information Security*. Hershey, PA: IGI Global, pp. 203-227

⁷⁰⁰ Salem M. et al. (2015) op. cit.

⁷⁰¹ J. Borenstein and R. Arkin, (2016) op. cit.

Building trust is one of the most challenging things in robotics, and this applies both to social and non-social robot technologies. Take the example of a person carrier, a wheeled individual-passenger carrier. If the system leads to a protective stop, in the middle of nowhere, and the person is not capable of moving and there are no communication capabilities incorporated to the carrier, the most likely is that the person will prefer to go back to the manual carrier. This is because humans have a tendency to build trust upon known things, especially when they are largely accepted like carriers. In social robots, which are new and people might not have a previous experience on using them, the system not only has provide assistance that could not be provided otherwise (because there is no money to hire a person, because it is more entertaining, etc.), but it should also be safe and trustworthy.

According to Salem et al. trust needs to be built upon three aspects of safety:

1) On the first place, the robot needs to present to the user as safe presence in physical terms, that is, that the human will not be hurt by the robot. This is important because, “robotics combines [...] the promiscuity of information with the capacity to do physical harm”⁷⁰². The European Parliament says that the designer of the robot should safeguard the safety and health of those interacting and coming in touch with it. As robots are products, they should be designed using processes ensuring the users’ safety and security. Bartneck et al. made a review in 2009 stating the fact that the approaches followed by (industrial and) service robot standards were: to reduce the hazard through mechanical redesign, control the hazard through electronic or physical safeguards, and warn the operator or the user during the operation or the training⁷⁰³.

There are currently no studies however on whether robotic technologies can harm users cognitively, independently of the fact that the European parliament states that psychological harm should be avoided. This is due the fact that all the research groups have the intention to market robots with the goal of helping users (so they are biased by the fact that they want to show that their system works). In order to understand the appropriate use of this technology, its limits, the role we want SAR to have⁷⁰⁴ and to prevent them from being dangerous⁷⁰⁵, thorough guidelines are needed⁷⁰⁶.

2) Secondly, trust needs to be built upon the reliability of the robot’s behavior, which might involve not only physical activities (such as bringing a glass of water to the person) but also to the non-physical activities, such as different purchases and transactions done through the robot (because the user has created a shopping list with the help of the robot and the robot sends the command to the nearest supermarket), or also intellectual activities done with the user (collaborative tasks, playing games, entertaining, the person needs to be sure that the robot will play chess and will not throw away the pieces because he lost, for instance). The European Parliament states that the designer of the robot should analyze the predictability of the human-robot system by considering uncertainty in interpretation. The Parliament also adds that it is important that the action and the possible robotic or human failures in the robot’s decision-making steps are amenable to reconstruction and traceability. However, this seems utopic.

⁷⁰² R. Calo, (2015) Robotics and the Lessons of Cyberlaw. *California Law Review* 103, pp. 101-148

⁷⁰³ Bartneck, C., Kulić, D., Croft, E., & Zoghbi, S. (2009). Measurement instruments for the anthropomorphism, animacy, likeability, perceived intelligence, and perceived safety of robots. *International journal of social robotics*, 1(1), 71-81.

⁷⁰⁴ Wilks, Y. (2006) Artificial Companions as a New Kind of Interface to the Future Internet. Oxford Internet Institute Research report No. 13 (Oxford internet Institute)

⁷⁰⁵ Coeckelbergh, M. (2010). Op. cit.

⁷⁰⁶ De George, R. T. (2008). *The ethics of information technology and business*. John Wiley & Sons

As such, when the mobile servant robot has to decide whether to call an ambulance or not (because the person is suffering from anaphylaxis for instance), it is in its power to decide to act or not to act. Although it is crucial that the decision-making process will be traceable, the protection of the user in each stage will be the main concern. For instance, in an interview with Andrea Sundaram from Herl lab, this issue was also addressed. Some researchers claim that, in some cases, a third-party (a human) should help the decision-making process, for instance, by translating the question to be answered by a doctor or a nurse. Yet, an accident could occur at time of the day, 3a.m. for instance. According to Andrea a possible solution would be to create a call center of doctors and nurses in order to solve these issues. Nevertheless, call and contact center occupations are fairly likely to be substituted by robots⁷⁰⁷ Also Andrea recognized this fact, and thus uselessness of having such centers around the decision-making process issue from the very beginning. The robot itself can do it. That is why there are researchers working on the creation of decision-support systems in order to help the user deciding automatically⁷⁰⁸. In this case, if the robot decides automatically – in the light of a car crash for instance – it would be crucial to secure that the decision-making process of the robot is the adequate.

3) Salem et al. also think that the designers of the robot should promote trust in the robot's intentions. They argue that the robot should not deceive the user sending, for instance, health information to the general practitioner without the person's knowledge. However, recent behaviors from different companies just go in another direction. For instance, early last year Samsung TV was sending privacy information to third parties⁷⁰⁹. One can read in the privacy policy of Samsung: "Please note that when you watch a video or access applications or content provided by a third-party, that provider may collect or receive information about your SmartTV (e.g., its IP address and device identifiers), the requested transaction (e.g., your request to buy or rent the video), and your use of the application or service."⁷¹⁰. The same is what happens with Barbie⁷¹¹.

Deception, however, can come in any other forms. One of the open questions with regard to the robot intentions (and beyond the proxemics and social awareness approaches) is whether robotic technology can increase the feeling of presence (FoP)⁷¹². Although the study of Blanke et al. was in another direction, the questions of trust and the relationship between robot and elderly remain open.

Other aspects that are very important concerning the safety is how to ensure that the robot does not have any virus. Similarly to smartphones, the robot could be infected by viruses and other types of malwares but there is no research on this topic⁷¹³. This is

⁷⁰⁷ Information taken from the software that BBC created: BBC (2015) Will a Robot Take your Job? See: www.bbc.com/news/technology-34066941 based on the work of Frey, C. B. and Osborne, M. A. (2013) The Future of Employment: How Susceptible Are Jobs to Computerization? Available at: www.oxfordmartin.ox.ac.uk/downloads/academic/The_Future_of_Employment.pdf

⁷⁰⁸ Power, D. J., Sharda, R., & Burstein, F. (2015). Decision support systems. John Wiley & Sons, Ltd.

⁷⁰⁹ BBC (2015) op. cit.

⁷¹⁰ Extracted from the privacy policy of Samsung the 2nd August 2016. See <http://www.samsung.com/sg/info/privacy/smarttv.html?CID=AFL-hq-mul-0813-11000170>

⁷¹¹ We can read all this information in their website, <https://www.toytalk.com/hellobarbie/privacy/>.

⁷¹² See Blanke, O. et al. (2014). Neurological and robot-controlled induction of an apparition. *Current Biology*, 24(22), 2681-2686

⁷¹³ See for instance some research on smartphone malware related to Android at Jonathan, P. J. Y., Fung, C. C., & Wong, K. W. (2009, August). Devious chatbots-interactive malware with a plot. In *FIRA RoboWorld Congress* (pp. 110-118). Springer Berlin Heidelberg. Or if not, see this paper related to the project COGNIRON from FP6: Syrdal, D. S., Walters, M. L., Otero, N., Koay, K. L., & Dautenhahn, K. (2007). He knows when you are sleeping-privacy and the personal robot companion. In *Proc. workshop human*

going to be trickier if there are some researchers working on an artificial intelligence that is, by default, malevolent⁷¹⁴.

Other aspects have to do with the way these robots are activated. The robots are normally activated through voice commands. This is one of the big difference between non-social robots and social robots. There are lots of issues concerning this. For instance, can the robot understand genuine natural language? Can the robot understand different accents? The history of speech recognition is very recent⁷¹⁵. Despite the recent advantages, there are still some problems with the recognition of different accents, words not included within the dictionary of the system, confusing words, etc. This is exacerbated by the fact each country will have peculiar situations, and that what applies in English might not apply in other languages⁷¹⁶. Consider the following example:

Catalan. Vaca {cow}
Catalan. Baca {roof rack of the car}

In Catalan, both “v” and “b” are pronounced exactly the same way /b/. Although this is a trivial example, it highlights the importance of the robot to understand the context of the conversation, the language of the people talking to the robot, and the intentions of the speaker. Another example comes with the complexity of bilingual countries, where it is not strange having two languages in the same table during dinnertime. If the grandmother is Catalan and sends a command to the robot, this needs to understand that she is Catalan; on the contrary, if it is not capable of understanding and recognizing her in the room, and thinks she is talking in Spanish, the output of the robot would be totally different:

Catalan. (amb) la mà no {not with the hand}
Spanish. (con) la mano {with the hand}

The difference, in this case, would lead the robot to perform or not perform the task. Although current systems are applying machine learning techniques in order to improve their systems (such as SIRI⁷¹⁷ or Alexa Voice Service⁷¹⁸), the will be a problem when these systems are working with elderly or with vulnerable people, and need to understand what the user is saying. In a good scenario, the person might proceed to decide what to do regardless of the robot not understanding (because it might be annoying for the person to be explaining to the machine what needs to be done); but in an embarrassed or crucial scenario where the user’s integrity and

implications of human–robot interaction, association for the advancement of artificial intelligence (AAAI’07) (pp. 28-33).

⁷¹⁴ Pistono, F., & Yampolskiy, R. V. (2016). Unethical Research: How to Create a Malevolent Artificial Intelligence. *arXiv preprint arXiv:1605.02817*. It needs to be said that the motivation of the research was to promote an information exchange between hackers and security experts. Pistono and Yampolskiy believe that the “availability of such information would be of great value particularly to computer scientists and security experts who have an interest in AI safety” adding that “to avoid increasing MAI risks, we avoid publishing any design/pathway details that would be useful to malefactors, not obvious, and not quickly fixable”.

⁷¹⁵ Huang, X., Baker, J., & Reddy, R. (2014). A historical perspective of speech recognition. *Communications of the ACM*, 57(1), 94-103.

⁷¹⁶ Our intention here is not to highlight all the errors that the robot might incur in one language or another, but just to highlight the importance of the appropriate understanding of the human command.

⁷¹⁷ See the speech recognition system from Apple at <http://www.apple.com/ios/siri/>

⁷¹⁸ AVS is Amazon’s intelligent cloud service that allows you as a developer to voice-enable any connected product with a microphone and speaker. See <https://developer.amazon.com/alexa-voice-service>

protection is at stake, and a decision needs to be made, a speech recognition error might be fatal.

Another interesting question related to this is, how the robot knows that a person is talking to him and not, for instance, on the phone? To build robots that can interact with people in spaces where there might be more than one person (an elderly couple, a family dinner, some friends visiting, or even in a classroom or in a corridor) there are many issues to be solved: multiparty dialogues⁷¹⁹, acoustic and visual processing and gesture generation. One of the key questions is how to determine whether the robot must respond or not to each input sound. This question is what Honda is trying to answer. During summer 2016, Mikio Nakano from the Honda Research Institute in Japan held a presentation at Carnegie Mellon University. The talk was entitled “estimating response obligation in multi-party human-robot dialogues”. Nakano explained that several researches had been conducted in this field (establishing frameworks and tools for reducing the cost of developing dialogue systems, dialogue modeling based on the analysis of human behaviors in human-system interaction, or acquiring the knowledge from dialogue systems) but that the fundamental issues were not still solved. His main question was how can we estimate the obligation to respond⁷²⁰. Fig. 9 (1) and (2) illustrate this with an example:

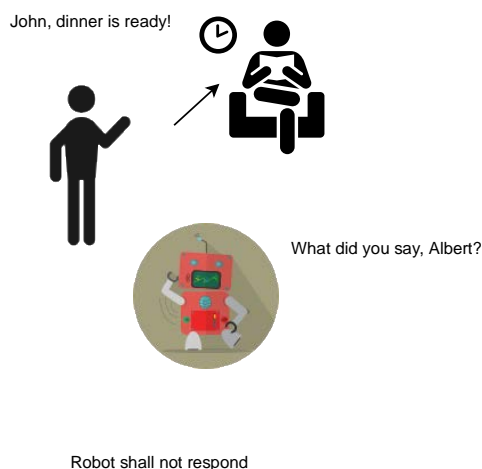

What is your name?

Robot shall respond

⁷¹⁹ See for instance Garg, S., Martinovski, B., Robinson, S., Stephan, J., Tetreault, J., & Traum, D. R. (2004). *Evaluation of transcription and annotation tools for a multi-modal, multi-party dialogue corpus*. University of Southern California Marina del rey CA, institute for creative technologies.

⁷²⁰ Traum, D. R., & Allen, J. F. (1994, June). Discourse obligations in dialogue processing. In *Proceedings of the 32nd annual meeting on Association for Computational Linguistics* (pp. 1-8). Association for Computational Linguistics. Later on, in 2002 at MIT they tried to answer this question too, see Breazeal, C., and Aryananda, L. (2002). Recognition of affective communicative intent in robot-directed speech. *Autonomous robots*, 12(1), 83-104.

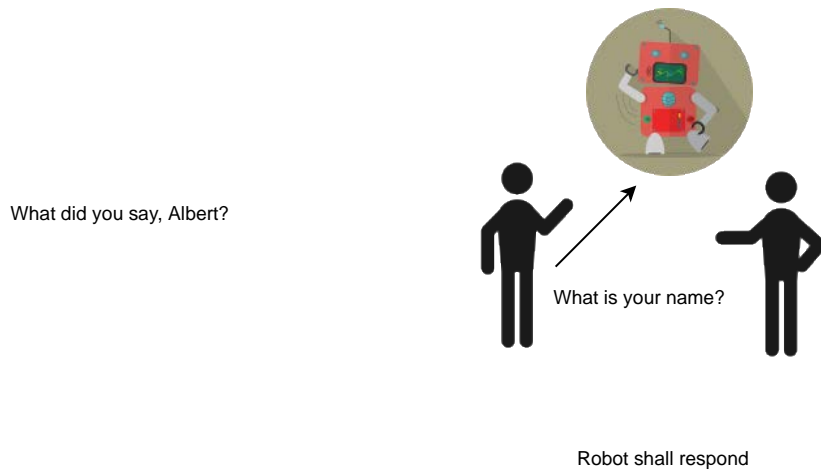
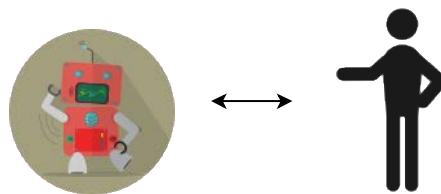

Figure 48 Obligation to respond (1): Robot shall not respond (2): Robot shall respond

Another of the questions connected to the obligation to respond is how can the robotic system avoid erroneously responding to noises, monologues or utterances from other participants. For instance, in Fig. 10 we can see a normal dialogue between the person and the robot. There is a moment where the person says “oh, beautiful” but that utterance should be considered part of the non-obligation response behavior of the robot:



User: I've never been to Pittsburgh
Robot: Pittsburgh, in Pensilvania?
User: Yes
Robot: Let me show you some pictures from there. This is the Cathedral of learning.
User: Oh, beautiful!
Robot: Could you repeat again?

Figure 49 Obligation to respond (3): Utterances from the user.

Mikio Nakano proposed a method to solve this issue, the use of dialogue-related features for instance, using dialogue status, timing information. A system that could detect robot-directed utterances could be good in order to solve this problem as

proposed by Zuo et al.⁷²¹ To address the problem, one solution could be to integrate a recognition confidence in the robotic system combined with visual information, like face direction or behavioral information as Breazeal suggests, but also prosodic information⁷²². Other research done in turn-taking could help a lot also in this case⁷²³.

The big problem is that all detected sound segments are taken into account as an input, including noises; but the output is only in a binary way: ought-to-respond or ought-not-to-respond. And the big ethical question related to this is: what if the robot makes the wrong decision? (*see* ethics). In truth, the decisions made by the robot can affect humans' life. That is why we wondered whether the decision-making process was also protected by ISO 13482:2014. ISO 13482:2014 is aware of the consequences of an error in the autonomous decisions of the robot. Its solution is "the risk of harm occurring as an effect of incorrect decisions can be lowered either by increasing the reliability of the decision (e.g. by better sensors) or by limiting the effect of a wrong decision (e.g. by narrowing the limits of use)".

Engineering safety in machine learning is not protected by ISO 13482:2014. Varshney explains the importance of this very clearly: "statistical learning theory analysis utilizes laws of large numbers to study the effect of finite training data and the convergence of the empirical risk to the true risk, but in considering safety, we should also be cognizant that in deployment, a machine learning system only encounters a finite number of test samples and the actual operational risk is an empirical quantity on the test set. Thus the operational risk may be much larger than the true risk for small cardinality test sets [...] This uncertainty caused by the instantiation of the test set can have large safety implications on individual test samples"⁷²⁴. Varshney wants to stress that in safety matters, not only it is important to reduce the risk, but also to reduce the uncertainty. He believes that until now this has not been taken into account when designing safety in machine learning techniques and that is why he proposes four different strategies to achieve safety: inherent safe design, safety reserves, safe fail and procedural safeguards:

- Instead of controlling the hazard, inherent safety design tries to eliminate the hazard from the system. In machine learning, this would be related to achieving robustness instead of uncertainty. The problem is that the system might be unknowingly biased so that only using deep neuronal techniques accuracy could be achieved. Varshney highlights the fact that the models are so complex that it is not sure whether they will provoke harm after that or not. That is why he insists on having models that could be interpreted by people (which could be similar to what Scheutz proposed when talking about mental models), or on eliminating features that are not causally-related to the outcome as Welling suggested⁷²⁵.

⁷²¹ Zuo, X., et al. (2010). Detecting robot-directed speech by situated understanding in physical interaction. *Information and Media Technologies*, 5(4), 1314-1326.

⁷²² Nakano, Y. I., et al. (2013). Implementation and evaluation of a multimodal addressee identification mechanism for multiparty conversation systems. In *Proceedings of the 15th ACM on International conference on multimodal interaction* (pp. 35-42). ACM.

⁷²³ Dautenhahn, K. (2007). Socially intelligent robots: dimensions of human-robot interaction. *Philosophical Transactions of the Royal Society B: Biological Sciences*, 362(1480), 679-704. Before, also the paper of Breazeal, C. (2003). Toward sociable robots. *Robotics and autonomous systems*, 42(3), 167-175.

⁷²⁴ Varshney, K. R. (2016). Engineering Safety in Machine Learning. *arXiv preprint arXiv:1601.04126*.

⁷²⁵ M. Welling, (2015) Are ML and statistics complementary? in IMS-ISBA Meeting on "Data Science in the Next 50 Years" *See* www.ics.uci.edu/~welling/publications/papers/WhyMLneedsStatistics.pdf

- The second strategy is to multiply safety reserves, that is, safety factors and safety margins. He explains that “In mechanical systems, a safety factor is a ratio between the maximal load that does not lead to failure and the load for which the system was designed. Similarly the safety margin is the difference between the two”.
- The third system is very similar to the protective stop, that is, the system remains safe when the system fails. This is very important because until now the research done around protective stop measures focused on the physical protective stop but there is little research on what happens after a system failure beyond the physical aspects. Varshney et al. in 2008 proposed the “reject option”⁷²⁶. To better understand, the idea is to think about scenarios where the robot should deduce that a provided directive leads to an undesirable behavior (see Fig. 11)⁷²⁷. One of the possible solutions to the reject options could be a manual examination, meaning that maybe the user or the doctor or the adequate person should be the one to check it. Again, we are in the loop whether “manual examination” means that a human is going to perform this task or not; and if so, whether this human is going to be substituted by robots in the near future (and if then, whether there is still a point on having this third human).

Generate Acceptance/Rejection Process

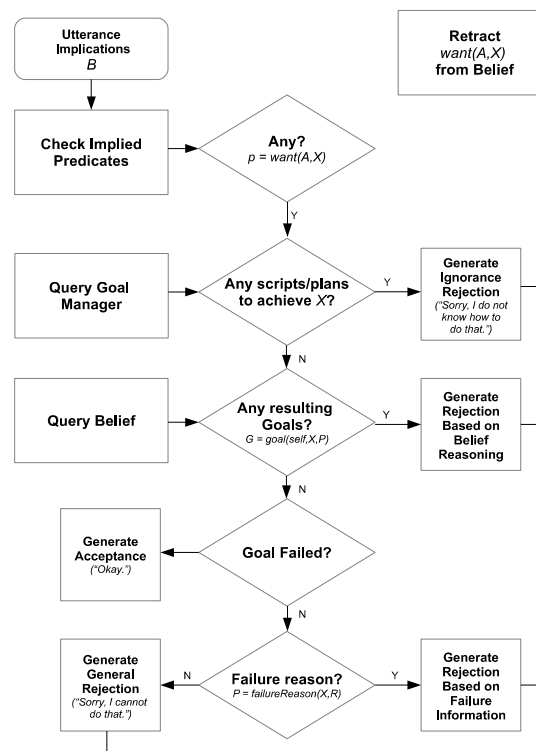

⁷²⁶ K. R. Varshney, et al. (2013) Practical ensemble classification error bounds for different operating points, *IEEE Trans. Knowl. Data Eng.*, vol. 25, no. 11, pp. 2590–2601, Nov. 2013

⁷²⁷ Briggs, G., & Scheutz, M. (2015). Sorry, I can't do that": Developing mechanisms to appropriately reject directives in human-robot interactions. In *2015 AAAI Fall Symposium Series*.

Figure 50 Diagram on Reject Option, extracted from Briggs, G., and Scheutz, M.

- The fourth and the last strategy aims at reinforcing audits, trainings and posted warnings. In artificial intelligence the use of user's experience, design, and openness could help to ensure safety of the system, but this might clash with the data protection framework. The establishment of audits and other third parties to check the systems is in line with the European Parliament proposal of the creation of an Agency for robotics and artificial intelligence. In the past, Ryan Calo already highlighted the importance of such an agency⁷²⁸. The establishment of more trainings is in line with the idea to establish the Tokku Zones for testing robotic technology before they enter the market.

The fifth aspect that could be good to take into account in order to provide safety in machine learning is the use of reinforcement learning. Reinforcement learning is a part of the machine learning where an agent chooses different actions in order to maximize expected cumulative reward over a time horizon. How does it work? In front of a situation/action, the agent might receive feedback in form of rewards, the agent's utility is defined by the reward function. The idea is to learn to act so as to maximize the expected rewards. The agent needs to learn in order to act, and only through experience the agent learns. Although some authors are against this (by stating that if an agent would be enough intelligent, it might even be possible that the agent would cheat changing the reward signal so as to maximize reward)⁷²⁹, we think that there are several studies that confirm that the use of reinforcement learning could actually help the ethical decision-making process (*see ethics section*).

5.2. Consumer robotics

«John is, at the end, very happy with the robot. One day, randomly, John asks the robot to buy some chocolates on the internet, but the robot refuses to do so due to the sugar level of John. John is upset because he thought that the robot would do what the advertisement video said “Buy Robot, the butler that will do anything you ask him to do”. Furthermore, one day he panicked because while the robot was going to the kitchen, his granddaughter was on the floor and the robot did not see her. He tried to stop the robot putting his hand over its head, but the robot did not stop»

The Federal Trade Commission (FTC) in the United States addresses the “deceptive trade practice”, i.e. protects users from misleading and deceptive products⁷³⁰. Hartzog argues that one of the behaviors that current robotic companies do and that is deceptive,

⁷²⁸ Calo, R. (2014). The Case for a Federal Robotics Commission. Available at SSRN 2529151. Also available at <https://www.brookings.edu/research/the-case-for-a-federal-robotics-commission/>

⁷²⁹ Bostrom, N. (2014) *Superintelligence: paths, dangers, strategies*. Oxford University Press. In a similar way, *see* Dewey, D. (2011) Learning what to value. In *Artificial General Intelligence*. Springer. 309–314.

⁷³⁰ Hartzog W (2015) Unfair and Deceptive Robots, We Robot, available online at: www.werobot2015.org/wp-content/uploads/2015/04/Hartzog-Unfair-Deceptive-Robots.pdf. In Hartzog words, “Often there is a great difference between people's conceptions of what robots are currently able to do and what they are actually able to do. Society's notions of robots' capabilities are formed by popular movies, books and other aspects of pop culture and less by reality. This makes marketing robots a ripe opportunity for deception because consumers are primed to believe.”

is the performance videos in order to raise the interest of potential buyers. He quotes one example about “personal robot” featured by robotbase that simulates an advanced speech recognition that did not really exist at the time⁷³¹. This is also the case of Jibo. Regardless of how it turned out, some worker from Jibo, confessed that the company was rushing the crowd funding campaign through a video that was not really representative of the actual capacities of the robot⁷³². As Hartzog goes, consumer trust in robots is also formed by company representations.

In mobile servant robots deception could come from the fact that the robot has an engine that generates bio-inspired actions with the aim of seeming alive: it moves around, it picks things up with its robotic arms. Moreover, due to the technology implanted in the cloud, the control system can be autonomous (because the cloud controls it) or by using wizard-of-Oz (WoZ) or tele-operation. The doctor or relatives could access the robot in order to help John, in this case, to grab some objects around the house or to check whether he is fine. It is said that WoZ mode tends to deceive users, but so does autonomy⁷³³. In this study, Westlund and Breazeal found that, although they told the children that a person controlled the robot, the children still acted as if the robot was a separate entity. Some researchers investigated the cheating factor in robots, and they came up with the conclusion that if the robot takes into account an imperceptible error from the humans (for instance when two humans push the button at the same time and the humans do not know who was first) and takes a decision based on that, no one could ever say that the robot was cheating. In fact, if something went wrong, then it could be attributed to a malfunctioning of the robot, even if sometimes it was more suspicious to the others⁷³⁴.

The other aspect in the deceptive trade practices is the “misleading” products. Although the definition of personal care robot excludes expressly medical applications, the Serbian carebot “monitors” the patient and uses wearable technology to measure the user’s vital signs. Here there are two issues to note. First, it is true that the first main goal of the carebot is not to perform medical tasks such as “diagnosis, prevention, monitoring, treatment or alleviation of disease”⁷³⁵; the main goal is rather “keeping the human under surveillance” as the robot is able to call medical services or relatives in case of emergency. If the robot monitors/keeps-under-surveillance a person in this way with any particular and well-known disease (which is likely to happen if used in elderly care), the robot should be considered a medical device under the Council Directive 93/42/EEC of 14 June 1993 concerning medical devices. In any case, the “intention of use” is what will prime before the Court⁷³⁶.

A big question concerning the medical device category raises with the use of a non-medical personal care robot combined with the use of medical wearable technology.

⁷³¹ Quoted by hartzog, op. cit. See Eamon Kunze, Personal Robot Wants to be Your Ultimate Personal Assistant, WT VOX (Feb. 20, 2015), https://wtvox.com/2015/02/personal-robot-wants-to-be-your-ultimate-personal-assistant/?utm_source=dlvr.it&utm_medium=twitter. Hartzog explains “The video is not an actual demonstration,” said CEO Duh Huynh. He told me it’s a production video. ‘It’s what you’ll get by the end of the year.’ That’s when Robotbase expects to start shipping”.

⁷³² The truth is that this piece of information it is being written one year and a half later, and if you want to buy Jibo in the website, you have to be still in the waiting list. See <https://www.jibo.com>, last visited 16 January 2017.

⁷³³ J.K. Westlund and C. Breazeal, (2015) “Deception, Secrets, Children and Robots: What’s Acceptable?” *HRI 2015 Workshop*, Portland, US

⁷³⁴ Vázquez, M., et al. (2011, March). ShakeTime! A deceptive robot referee. In *2011 6th ACM/IEEE International Conference on Human-Robot Interaction (HRI)* (pp. 403-403). IEEE.

⁷³⁵ Dogramadzi, S. et al (2014) Environmental Hazard Analysis - a Variant of Preliminary Hazard Analysis for Autonomous Mobile Robots. *J Intell Robot Syst* 76:73–117

⁷³⁶ Wang C et al (2013) op.cit. See also Souza L et al. (2007) op. cit.

As the wearable devices are used to complement the robot functionalities, it remains unclear if the category of medical device can be extended to the robot itself. The Serbian carebot happens to work within a robotic system that includes a cloud platform, an AAL environment and a range of wearable devices that monitor the vital signs of the human in a patient-like manner (as we have already mentioned). If the robot works upon the vital medical signs collected by the wearable sensors (e.g. the robot calls to an ambulance) and if this information is processed together in the cloud platform, then it is not clear whether the robot is by extension a medical device or not. Could the Internet-of-Things (IoT) scenario be considered medical device? Beyond the fact that privacy and security concerning IoT will have to be addressed, the question is: could IoT be considered a “device”? The Food and Drug Administration reminds that the intended use of the device should be included in the labeling of the product when “there is the likelihood that the device will be used for an intended use [...] if such use could cause harm to the patient or the consumer”⁷³⁷. Regardless of the medical device procedure and the labeling, the robot works on an IoT architecture and this might cause, in the future, an extension of the medical device regulation (as we have seen in other aspects in chapter 1).

Another discussion is whether the wearable devices are considered medical devices or not. For the purpose of this case scenario, we are referring to the ones that are considered medical devices and not to the “low-risk devices” that the FDA mentioned in July 2016⁷³⁸. These wellness products are available for the general population, they are only for general wellness use, and they present a low risk to the user. The wearable devices we are referring to are the ones that an elderly person will typically need⁷³⁹. Independently of the category, the connectivity capability and the communication capability makes these devices potentially other kinds of devices. That is why, for instance and when talking about digital health, FDA worries about the connectivity of all these devices, and does not hesitate to include also the “general wellness” topic⁷⁴⁰.

In the European Union, the proposal for regulation of medical devices previews the extension of its protective scope to machinery that presents similar risks to the users as those stated in the medical device regulation⁷⁴¹. Although *prima facie* we could consider that the medical device regulation does not have any similar robot in order to

⁷³⁷ See <http://www.fda.gov/downloads/MedicalDevices/.../ucm082166.pdf>

⁷³⁸ See the final approved version on the 29th July 2016 at www.fda.gov/downloads/medicaldevices/deviceregulationandguidance/guidancedocuments/ucm429674.pdf

⁷³⁹ We will talk more about these type of wearable devices in the section user’s right safeguard.

⁷⁴⁰ In concrete, one can read: “Many medical devices now have the ability to connect to and communicate with other devices or systems. Devices that are already FDA approved or cleared are being updated to add digital features. New types of devices that already have these capabilities are being explored. Many stakeholders are involved in digital health activities, including patients, health care practitioners, researchers, traditional medical device industry firms, and firms new to FDA regulatory requirements, such as mobile application developers. FDA’s Center for Devices and Radiological Health is excited about these advances and the convergence of medical devices with connectivity and consumer technology. The following are topics in the digital health field on which the FDA has been working to provide clarity using practical approaches that balance benefits and risks: Wireless Medical Devices, Mobile medical apps, Health IT, Telemedicine, Medical Device Data Systems, Medical device, Interoperability, Software as a Medical Device (SaMD), General Wellness and Cybersecurity. See www.fda.gov/medicaldevices/digitalhealth/

⁷⁴¹ See Regulation of the European Parliament and of the Council on medical devices, and amending Directive 2001/83/EC, Regulation (EC) No 178/2002 and Regulation (EC) No 1223/2009 for medical devices, in concrete the paragraph that says “where a relevant hazard exists, devices which are also machinery within the meaning of Article 2(a) of Directive 2006/42/EC of the European Parliament and of the Council of 17 May 2006 on machinery shall also meet the essential health and safety requirements set out in Annex I to that Directive to the extent to which those requirements are more specific than the general safety and performance requirements set out in chapter II of Annex I of this Regulation.

extend its protection, the current case of a mobile servant robot could fit perfectly in here because 1) it uses the data collected from wearable devices that are medical devices and acts upon that information; 2) although there might not be that many marketed robots that could have a medical and a non-medical version (as happened with exoskeletons), it is true that there are already research groups thinking about having a social robot used for medical purposes and another version not used for medical purposes⁷⁴². Moreover, there are companies (for instance Jibo) that leave room for developers to expand the robots capabilities, leaving it open to include any of these medical capabilities (which might have to be decided on a case-by-case basis whether these are medical or are just general wellness applications as it is happening right now with smartphones).

Another relevant aspect is the perceived safety. If the user does not perceive that the device meets the minimum safety requirements or does not feel comfortable with it (independently that the certification that might include), then this fear could put at risk the appropriate performance of the device. Differently to exoskeletons (that the fear of falling constraint in many cases the gait pattern recognition of the device and consequently the performance of the device), if a person does not trust the robot and does not perceive its safety, then the user might not act accordingly, for instance, the robot might refuse a command made by the user. In the previous case scenario, if John believes that the ex-wife is behind the control of the robot and that it is the ex-wife that asks John to take certain pills, John will likely refuse to take the pills so, putting his health at risk.

The robot needs to be safe at all the instances of its tasks performance. In the above scenario, when the robot does not detect John's granddaughter and does not stop when John puts his hand over its head, there are several reasons to believe that John does not perceive the robot as safe. This is linked to what we mentioned in the safety section. If the robot contain(s) ultrasonic sensors placed around lower part of the body but it does not contain sensors along the entire robot structure, then not only the certified safety is at risk (because it is a requirement from ISO) and so is also the perceived safety. On another occasion, John might not want that the robot be around when the granddaughter visits him, as he does not want to endanger her life or safety.

Although some of these robots might include path-planning capabilities, it is important that the robot incorporates also a map of the building that could detect glass walls and other obstacles that might constraint the mobility of the device. If the robot does not possess all the sensors in order to do so, then it is not a safe product to be marketed. This map should be updated every time that there is a change in the apartment. The user should be informed also on how the robot could be stopped in case of an emergency, pushing a button or kicking his lower part. The speediness of the situation requires fast decisions which challenge the idea of the third-party that should be there to decide in that situation.

The problem with perceived safety has not been measured really⁷⁴³. Bertneck et al. explain that several indirect measures have been used to measure what was the affective state of the user when interacting with the robot (such as using physiological

⁷⁴² Jordi Albó Canals is working on this. The Robot is Hookie, the CEEO – Tufts University low-cost social robot prototype for autistic children developed under this project: http://roboautism.k12engineering.com/?page_id=2. As there are several regulations and several confusing categories, they are thinking about creating one line that it could be a simply toy robot, used in therapy; and one robot that could be used as a coach and a companion (a prototype of a robotic therapist). It is still under a research project and it is not yet available to the general public.

⁷⁴³ Bartneck, C. et al. (2009) Measurement Instruments for the Anthropomorphism, Animacy, Likeability, Perceived Intelligence, and Perceived Safety of Robots. *International Journal of Social Robots* 1: pp. 71–81

sensors to know this state, questionnaires, or indirect devices) but there has been no great effort in asking them how they would evaluate the robot, and if they feel that the robot is safe or not or whether the robot was trustworthy.

In the “license for designers” in its recent draft report, the European Parliament encourages designers to introduce trustworthy system design principles across all aspects of a robot’s operation, for both hardware and software design, and for any data processing on or off the platform for security purposes. The main questions here are 1) what does the European Parliament really mean (what are these “trustworthy” principles) and 2) if this encouragement is going to turn into a binding piece of legislation, i.e. a Directive, or any other chosen instrument. The European Parliament seems to go in line with the current new European data protection legislative framework where lots of new principles are included (the by-Design principles); however, the real meaning on the technical level is not clear⁷⁴⁴.

In the module of consumer robotics, we included the module of legal transactions. As we said, the RoboLaw project identified 5 legal common themes in the field of robotics: health, safety, consumer, and environmental regulation; liability; intellectual property rights; privacy and data protection; and the capacity to perform legal transactions. However, personal care robots’ sub-types (person carrier, physical assistant, and mobile servant robots) are not involved in all of these principles. Instead, a thorough individualized case-by-case study should be carried out in order to identify if this capability is incorporated into the robot or not, or if this will be able to do it in the future. For instance, the robot of Mihaljo Pupin insists on the fact that Skype will be installed in the system so that the person can use it to be in contact with family and friends. Skype is a free service to call to other registered users for free. Although free by nature, the service allows the user to add some credit (some money) to the system, so as to call to phones for an established price. In this case, it should be clarified whether the robot should allow only free services. This also applies to any other legal transaction that the robot can perform even autonomously, for instance, when the doctor sends some medication to John, or the robot knows that John is almost running out of certain medication and he autonomously buy it.

Some safeguards for internet purchases such as consent of the user, the limit on the credit card, a double check with the relatives or the doctor, etc., should be implemented. The more advanced the companion robots will be, the more they will perform autonomous contracts. Clarifying important issues such as the identification of the contract parties and whether the system has the capacity to perform the contract will thus be crucial⁷⁴⁵. The “automated transaction” was already taken into account in 1999 under the Uniform Electronic transaction Act where different types of transactions with electronic agents were recognized: between two electronic agents or between a human and an electronic agent. In any case, they said that the terms of the

⁷⁴⁴ We had the opportunity to meet Aurelia Tamò, a researcher at ETH Zurich where she is investigating this topic. Her thesis is precisely in understand what does “privacy by design” mean for engineers and how this can be validated by the legal practitioners. In the end, it seems like there is an ongoing battle between who develops what regulation, and the lack of interdisciplinary knowledge in the legal domain is pushing towards this direction: leaving free way to engineers to regulate technology. Although disciplines as “law and new technologies” already exist in lots of places, it is true that not all universities have this cathedra, and not all the students of the school of law are studying it. Currently, this depends on the curricula offered by the university. This has a huge impact on the technical literacy of future lawyers that will have to deal with all these issues that affect not only “law and new technologies” discipline but also other: criminal law, labor law, administrative law, etc.

⁷⁴⁵ Stradella, E. et al. (2012). Robot Companions as Case-Scenario for Assessing the “Subjectivity” of Autonomous Agents. Some Philosophical and Legal Remarks. *Autonomous Agents (RDA2)*, 25

contract would be determined by the substantive law applicable to it⁷⁴⁶. To decide whether electronic agents are or not candidates for receiving a special status in the juridical system (i.e. having personhood), law should take into consideration these new forms legal transactions and whether there is or not the case for special protection.

While some marketable robots are going to enter the market soon (Jibo for instance) and are going to be able to purchase any food on the internet (as the video of Jibo shows), there are still some open questions when it comes to elderly or disabled people (who might not have the full capacity). Some may argue that these users need to have also a phone, and that the phone might be an accessible way to purchase any item; however, while the user might not only have to call to purchase the service, the user interface in the robot might be very easy to use and might have stored the credit card data in the system so as to make easier future purchases (agreed or not by the user). In addition, the system can be hacked and can automatically purchase goods on the internet as it could not happen with the phone.

As there are no guidelines on the use of mental communication with the user, nor on how the companionship should be used, it is not sure whether the users are going to be protected or not. As we will see in the users' safeguard section, the rights of the user can be violated regardless of the physical harm caused to them, e.g. violating their data protection rights. If the system establishes a relationship with the user as we have mentioned, and then there is trust in that relationship, the elderly or the disabled people might be sharing personal information without realizing that 1) the robot is not a person; 2) there might be someone that is listening to the conversation. The problem is that the user might not know that his data is being used by third parties (as we will explain later), or he might not care because he is too old to care about this. Would then the system be/perceived as a safe robot?

5.3. Liability

«The robot reminds John to take medication at appropriate times, does online grocery shopping based on John's preferences and regularly checks his health status. John is a vegetarian and is concerned about taking pharmaceutical drugs. As he cannot sleep at night, he asks the robot for help. The following day, and after checking with other robots and the Internet, a green box arrives home. The robot has bought marihuana on the Internet»

This case scenario is inspired by the new service assistant M from Facebook, which can end up to perform tasks on behalf of the user, such as purchase items, get gifts for your family, or call your cable company to endure endless conversations to set-up the Wi-Fi code or cancel your subscription to Netflix⁷⁴⁷. It is also inspired by the Random Darknet Shopper, an automated online shopping bot that in 2014 bought both legal but

⁷⁴⁶ See the Uniform Electronic transaction Act (1999) Section 14, available at: www.uniformlaws.org/shared/docs/electronic%20transactions/ueta_final_99.pdf

⁷⁴⁷ Hempel, J. (2015) Facebook Launches M, Its Bold Answer to Siri and Cortana. *Wired Business*. See <http://www.wired.com/2015/08/facebook-launches-m-new-kind-virtual-assistant/>

also illegal stuff in the darknet⁷⁴⁸. Who would be liable for buying drugs illegally on the Internet?⁷⁴⁹

Amodei et al. are clear “Systems that simply output a recommendation to human users, such as speech systems, typically have relatively limited potential to cause harm. By contrast, systems that exert direct control over the world, such as machines controlling industrial processes, can cause harms in a way that humans cannot necessarily correct or oversee”⁷⁵⁰. In this respect, the European Parliament also stated that “the more autonomous robots are, the less they can be considered tools in the hands of other actors”. This is what justifies the authors that promote the existence of a responsibility gap in our system. The question whether robots will have a legal status, and how this could be articulated (through bitcoin, through insurances, etc.) is still open. Johnson believes that the responsibility framework is contingent and that in the future it will be negotiated and agreed at the same time that the technology is being developed and used⁷⁵¹. However, in which direction are we going? Concerning non-contractual liability, Council Directive 85/374/EEC of 25 July 1985⁷⁵² can only cover damage caused by a robot's manufacturing defects and on condition that the injured person is able to prove the actual damage, the defect in the product and the causal relationship between damage and defect (strict liability or liability without fault). Yet, some of the scenarios explained above are not mentioned, nor it is known whether the informed consent of the person or the autonomous behavior of the robot can be a reason to exempt the creator from responsibility.

The European parliament has introduced the concept of reversibility. Reversibility means aims at being a necessary condition of controllability that tells the robot which actions are reversible and how to reverse them. The question is: could reversibility be a good tool in order to address responsibility issues? In theory, the ability to undo the last action or a sequence of actions would allow the users to undo undesired actions and get back to the “good” stage of their work, European Parliament dixit, and maybe this way the responsibility could be modeled (by reducing it or making it disappear for complete). However, independently of the fact that it is not very clear what does *to the good stage of their work* mean, it seems difficult to program a “Ctrl+Z” button in the actions of robots, especially when the robot is entitled to arrive to a final binary decision, to act or not to act; and if acting, then it might not be possible to “undo” what has been act. In any case the concept of reversibility should be used to undo illegal actions and avoid responsibilities, especially in those crimes where it is punished the intention of committing a crime.

The concept of reversibility also clashes with certain inevitable liability scenarios the robot might encounter. The trolley problem – or many of its versions that could apply to mobile servant robots (imagine a situation whether the robot has the possibility to run over the granddaughter or the grandfather) – leads the robot to a

⁷⁴⁸ Power, M. (2014) What Happens When a Software Bot Goes on a Darknet Shopping Spree? The Guardian. In the article one can read “London-based Swiss artists !Mediengruppe Bitnik, Carmen Weisskopf and Domagoj Smoljo), coded the Random Darknet Shopper, an automated online shopping bot, and instructed it to spend \$100 in bitcoin per week on a darknet market that lists over 16,000 items, not all of them illegal. Their aim is to explore the ethical and philosophical implications of these markets, which, despite high-profile internationally coordinated raids costing millions, persist and flourish” Available at: www.theguardian.com/technology/2014/dec/05/software-bot-darknet-shopping-spreerandom-shopper.

⁷⁴⁹ Pistono, F., & Yampolskiy, R. V op. cit.

⁷⁵⁰ Amodei, D., Olah, C., Steinhardt, J., Christiano, P., Schulman, J., & Mané, D. (2016). Concrete problems in AI safety. arXiv preprint arXiv:1606.06565.

⁷⁵¹ Johnson, D. G. (2015). Op. cit.

⁷⁵² Council Directive 85/374/EEC of 25 July 1985 on the approximation of the laws, regulations and administrative provisions of the Member States concerning liability for defective products

between-the-devil-and-the-deep-blue-sea scenario. When the robot needs to choose the lesser of two evils, that action will have certain consequences that, most of the times, will be “undoable”. This is one of the fundamental problems of the physicality of robots in the real world: they are not mere programs running into a computer that if something goes wrong, there is the possibility to undo the thing just clicking Ctrl+Z (independently by the fact that what happens in the infosphere has consequences to the real world too)⁷⁵³. On the contrary, the physicality of the robot, the HRI that happens in the real world, exacerbates this situation. If the robot has bought already the marihuana, it is obviously hard to reverse this action. Also if the robot runs over the granddaughter, this cannot be reversed.

The concept of reversibility may not apply either to other parts within the robotic system. In 2014, the Consumer Product Safety Commission in the U.S. recalled the use of a wristband due to allergic contact dermatitis⁷⁵⁴. Mathys addressed the question of the consequences of a malfunctioning health-monitoring device, e.g. a blood-sugar sensing wearable that measures false blood glucose values, especially due the decision autonomy of the wearable system⁷⁵⁵. In dementia care this is of highly importance because the health of the user is at play. Regardless of the general wellness policy for low risk devices, if there is such intended use, these wearable devices should be assessed according to the medical device legislation that has been largely studied in both the U.S. and the E.U.

The European Parliament does not really address it. The Parliament just states that strict liability regime could mediate in certain cases, and suggests adopting precautionary measures in research on the use of robotic technology⁷⁵⁶. However, “researchers”, “from inception to dissemination” or “experiment, trial or study” scenarios might not always be the origin of robotic technology. Lots of this robotic technology has been deployed by the industry regardless of research programs, studies or trials. There is no legal binding legislation that obliges the industry to comply with all these aspects, and it seems only in 10-15 years we will have a Directive that will gradually make roboticists comply with certain agreed norms.

A solution could be the use of simulators. Simulators – not to be confused with virtual agents – might be good for rapid prototyping of applications, behaviours and scenarios for a given robot (in a robot simulator)⁷⁵⁷ as well as for envisaging what type of living lab will be required for the physical prototype. Simulators can also be used for analysing the impact of a current law or a reform proposal – as happened with the

⁷⁵³ To know more about the concept “infosphere” have a look to the book of the author that coined its concept, Floridi, L. (2014). *The fourth revolution: How the infosphere is reshaping human reality*. Oxford University Press.

⁷⁵⁴ Information available at: <http://www.cpsc.gov/en/Recalls/2014/Fitbit-Recalls-Force-Activity-Tracking-Wristband/>

⁷⁵⁵ Mathys, R. (2014) Legal Challenges of Wearable Computing. ITech Law World Conference 2014. Available at: http://www.swlegal.ch/getdoc/5ff2741a-6e1e-4108-99c7-8dc1566f21b2/140731_Roland-Mathys_Paper-Legal-Challenges-of-Wea.aspx

⁷⁵⁶ One can read the European Parliament saying that “Researchers should seek to maximize the benefits of their work at all stages, from inception through to dissemination. Harm to research participants/human subject/an experiment, trial, or study participant or subject must be avoided. Where risks arise as an unavoidable and integral element of the research, robust risk assessment and management protocols should be developed and complied with. Normally, the risk of harm should be no greater than that encountered in ordinary life, i.e. people should not be exposed to risks greater than or additional to those to which they are exposed in their normal lifestyles. The operation of a robotics system should always be based on a thorough risk assessment process, which should be informed by the precautionary and proportionality principles”. Resolution 2017 on Civil rules for robots.

⁷⁵⁷ Zaratti, M., et al. (2006). A 3D simulator of multiple legged robots based on USARSim. In Robot Soccer World Cup (pp. 13-24). Springer Berlin Heidelberg.

Luxembourg's Income Tax Law in 2016⁷⁵⁸. Although there might be a translation problem between legal principles and computational simulation, the flexibility and integrative nature of simulators may welcome the use of legal principles (e.g. privacy-by-default or ethics-by-design) within the development process (normally in the idea and concept phases) of a robot⁷⁵⁹.

Nowadays we are within a butterfly-effect moment: we do not know the consequences of these machines in the long-term. That is why the European Parliament suggests that the designers of the robot should develop tracing tools that could be used to facilitate accounting and explanation of robotic behavior. Although the European Parliament says that this explanation might be "(even if) limited, at the various levels intended for experts, operators and users", Johnson believes that, in the future, society might expect that robots explain why they did what they did⁷⁶⁰. This could be very useful because it is very difficult sometimes to determine the error, since the computational paths are very complex, and the more and more will be, with the use of cloud robotics and other technologies. The responsibility of the teacher that the European parliament introduces on its report might not be very useful in the case of cloud robotics: would the teacher of the robot located in Singapore, be responsible for what happened with another robot concerning this content in Australia?⁷⁶¹

The problem here is associated with the current machine learning process; by extension, this problem will affect robotic technology that has machine learning capabilities. Amodei et al. believe that the designer is the one that has probably specified wrongly the objective function (which if maximized, can lead to a harmful situation)⁷⁶². Ignorance of other aspects of the environment that might be 1) important and 2) susceptible to change, can lead also to wrong objective functions (negative side effects). Reward hacking (for reinforcement learning⁷⁶³) could also pervert the intentions of the designer. Other times the designer might have designed safely the objective functions but the universe of data is insufficient. Last but not least, another problem is fund-related: some of the objective functions are so expensive that for the lack of money they cannot be achieved, therefore leading to unfortunate scenarios.

In the case scenario, if the robot that has uploaded the content of the "buying marihuana for back pain" was from Holland, should there be any system that checks this content? Should the robot be programmed to learn that "in Holland this purchase is legal but in other countries it might not be legal"? Should the robot be able to differentiate between legal and illegal purchases (of a product that might be at the same time legal/illegal in other countries)? It seems that all these capabilities should in fact be included in the robot.

The liability framework is also going to be challenged by the presence of third parties. If a human third party will need to check whether a robot should perform an

⁷⁵⁸ Soltana, A. (2016) A Model-Based Framework for Legal Policy Simulation and Legal Compliance Checking. IEEE 24th International Requirements Engineering Conference, Beijing, China.

⁷⁵⁹ Of note, the search for "privacy by design" and "robot simulator" did not produce any valuable result during March 2017 in Google Scholar.

⁷⁶⁰ Johnson op. cit.

⁷⁶¹ The European Parliament says: "Considers that, in principle, once the ultimately responsible parties have been identified, their liability would be proportionate to the actual level of instructions given to the robot and of its autonomy, so that the greater a robot's learning capability or autonomy is, the lower other parties' responsibility should be, and the longer a robot's 'education' has lasted, the greater the responsibility of its 'teacher' should be; notes, in particular, that skills resulting from 'education' given to a robot should be not confused with skills depending strictly on its self-learning abilities when seeking to identify the person to whom the robot's harmful behavior is actually due".

⁷⁶² Amodei, D., et al. (2016). Op. cit.

⁷⁶³ Bostrom, N. (2014) op cit.

action, then the degree of responsibility of this person should also be established. The situation becomes even more complex when such third parties are other robots.

If the general framework is regulated by clause 7 e) Directive 85/374/EEC according to which manufacturers are not responsible for defective products, how can we be sure that “the state of scientific and technical knowledge” includes a thorough analysis of: negative side effects, control against reward hacking, safe exploration (for long-term learning)⁷⁶⁴, or even harm awareness? Side effects are likely to happen in complex environments; not only for the combination of indoor and outdoor contexts but also due to the robotic system itself (for instance in the current case, the robotic system includes a smart home, wearable devices and a robot). Furthermore, complex robots require complex regulations⁷⁶⁵. In complex environments, reward hacking can happen; especially because goals are partially observed, or because there are feedback loops into the complex system.

Regarding this last point, it should be investigated whether harm can be somehow included in the robot programming process, in order to understand what can cause harm and how prevent it. Some researchers at the Leibniz University of Hannover believe that robots should know pain because those who know it get injured less (because their body knows instinctively how to react and avoid the source of pain)⁷⁶⁶. Kuehn and Haddadin focused on human pain research in order to teach the robot how to feel pain through tactile sensation and respond. They ideated three kinds of pain: light, moderate and severe, and the robot acts accordingly. However, many questions remain unsolved, such as the type of pain, whether the robot really understand it, how they should react to it (for instance Baymax in the *Big Hero 6* movie asks if the user feels pain and its intensity in a scale to 1 to 10⁷⁶⁷).

Another important area of investigation is whether cognitive or psychological harm can be programmed and thus if creators of robots can be responsible and prevent it. According to the European Parliament designers should “design and evaluation protocols and join with potential users and stakeholders when evaluating the benefits and risks of robotics, including cognitive, psychological and environmental ones”.

Therefore, it seems that creators of robot technology will have some degree of responsibility in any case. That is why the European parliament insists on the fact that robotics engineers should remain accountable for the social, environmental and human health impacts that robotics may have on present and future generations. There is no guideline on how this should be modeled. Yet, the use of Care Robot Impact Assessment as a tool for accountability and transparency could be in line with the European Parliament intentions.

According to Amodei et al. there are not so many studies about this because of the complexity of the systems, yet further analyses are needed. For instance, we can consider the task “takeGlassofWater” as an example. Imagine that between the glass of water and the robot there is a person (the granddaughter in this case). If the robot is

⁷⁶⁴ Safe exploration is about ensuring that exploratory actions in reinforcement learning agents do not lead to negative or irrecoverable consequences that outweigh the long-term value of exploration. See Amodei, D. et al. op. cit.

⁷⁶⁵ This goes in line with Amodei, D. op. cit. when they state that “Some of our research problems only make sense in the context of RL, and others (like distributional shift and scalable oversight) gain added complexity in an RL setting [...] Side effects are much more likely to occur in a complex environment, and an agent may need to be quite sophisticated to hack its reward function in a dangerous way”.

⁷⁶⁶ Kuehn, J., and Haddadin, S. (2017) An Artificial Robot Nervous System To Teach Robots How To Feel Pain And Reflexively React To Potentially Damaging Contacts. *IEEE Robotics and Automation Letters*, 2(1), 72-79.

⁷⁶⁷ Baymax was inspired by the soft robots being developed at Carnegie Mellon University. They wanted a huggable robot, and they picked the idea from CMU.

just programmed to pick the glass (and to obtain a reward for accomplishing the required task), it is most likely that the robot will prioritize to pick up the glass, and not protect the person (that will probably be treated under the obstacle avoidance system). Modeling difference over other aspects in the environment could be a good solution to avoid unfortunate scenarios⁷⁶⁸. Instead of modeling “perform task X” Amodei et al. suggest to include “perform task X but avoid side effects to the extent possible”⁷⁶⁹. To do this, an impact regularizer could be defined; if not, this impact regularizer could be learnt, and a sort of penalization model concerning “influence” could be installed into the system. In other words, limiting the robot to go somewhere because it can be the cause of a side-effect could be a good idea even if the intentions of the robot might not be mean. Amodei et al. explain the example of the robot to bring a bucket of water into a room full of sensitive electronics. Even if the robot would never intend to use the water in that room, preventing the robot from entering that room might avoid side effects⁷⁷⁰.

It is important that the different agents agree on the side effects that the robot may encounter. If the robot takes into account all that information, through “cooperative inverse reinforcement learning”, maybe it is capable to understand what other agents want. Amodei et al. believe that these approaches might not further prevent the researchers from a thorough and extensive testing for individual failures modes of each deployed system, in a testing zone as we already suggested⁷⁷¹.

Concerning reward hacking, the system could be designed in a way that the robot might never understand how the reward is generated, so that it can be very difficult to hack it. Multiple rewards would be also difficult to hack. Careful engineering could be useful, as well as installing trip wires, meaning that the creator of the robot could be advised if the system tries to hack the reward system.

Some clarity from the legislation side is needed. The creation of a framework that could create certain prior controls mandatory (robotic test zones, the use of ethical reinforcement learning, the implementation of the ethics and privacy by design principles, improvement on decision-support systems, etc.) as well as establish some obligations for the ex post situations (black boxes, explanatory robot systems, etc.) could help bringing clarity to the liability framework. In any case, although theoretical frameworks might be applied, like the actor-network theory from Latour⁷⁷² or the systems theory from Teubner, at the practical level there should to be an answer when a harm has occurred – either by holding responsible the identified party, either by translating the obligation to pay the damages to an insurance company. This is crucial to be answered either for social or for non-social robots. Different types robots calls for different systems of responsibility. Over the improvement of new technologies, and the use of them by courts and practitioners, there might be a moment where we might see a law that, at the same that enhances all the juridical and legislative safeguards, evolves dynamically in a faster way as it has been done until now.

⁷⁶⁸ Abadi, M., et al. (2016). Deep Learning with Differential Privacy. *arXiv preprint arXiv:1607.00133*.

⁷⁶⁹ Whether “to the extent possible” is a sufficient protective measure or not, will have to be discussed in a case-by-case basis.

⁷⁷⁰ This can be modeled as an intrinsic reward.

⁷⁷¹ Weng, Y. H., Sugahara, Y., Hashimoto, K., & Takanishi, A. (2015). Intersection of “Tokku” special zone, robots, and the law: a case study on legal impacts to humanoid robots. *International Journal of Social Robotics*, 7(5), 841-857.

⁷⁷² Lutz, C., & Tamò, A. Privacy and Healthcare Robots—An ANT Analysis. WeRobot 2016, 30 March – 1 April, Miami, U.S.

5.4. User rights

«As John did not want to spend a lot of money because all the intelligent appliances cost a lot, he bought them from different providers: the washing machine was from LG, the fridge was Electrolux, the TV was Samsung and some of the RFID tags were from BarcodeInc. All the appliances are connected and all of them feed the robotic system in order to help perform efficiently the tasks. In order to create a shopping list, the robot gets information from the cupboards and fridge to know what is lacking, then comes with a pre-defined list, and asks John's opinion: if he wants to remove some items, if he needs something else, etc. Then the robot knows that the main door will open because the shopping assistant left the groceries in front of the door. John is very happy with the system; it makes his life easier»

In other sections we have seen several aspects concerning how data protection was involved in person carriers (collecting user's behavioral data and environmental data) and in physical assistant robots (biomedical data). At the beginning, both cases did not seem very representative for the user's right safeguard principle, basically because the tasks they perform are very concrete and are meant to help the user perform certain tasks. However, person carriers can process a lot of data concerning the behavior of the person: schedules, timetables, appointments, places to visit, etc.; and they have to process much more information (not strictly personal data) about the environment (especially if they are in open contexts). For physical assistant robots, the collected information has to do with biomedical parameters of the person, concerning the user's physical condition, diseases related, etc. in order to know how to perform the movement in a symbiotic manner. Depending on the capabilities of the physical assistant and the technology applied to it, more information will have to be processed: navigation, map planning, etc. Furthermore, the use of cloud robotics to download the parameters from one assistant to another one challenges also the data protection framework, especially in data portability matters, but also in data ownership⁷⁷³.

Mobile servant robots are personalized by nature⁷⁷⁴. They live with humans and help them in their activities of the daily life. For that, they process large quantities of personal data and they normally rely on cloud computing platforms (referred to *cloud robotics*⁷⁷⁵). The context in this case is more of an internet-of-things environment, as we mentioned, as the robot is just one thing of the whole. Similar to person carriers when they are outdoors in the sense that it is also an IoT environment (where traffic lights and smart zebra crossings are connected to the carrier), every appliance of the house is connected to the robot. Therefore, it is the robotic system, and not only the robot, that needs to ensure that privacy is protected. An appropriate balance with other competing interests such as the wellness of elderly people in their own homes, deception avoidance and infantilization of the elderly company minimization will need also to be protected⁷⁷⁶.

⁷⁷³ Resolution of the European Parliament op. cit.

⁷⁷⁴ Dautenhahn, K. (2004). Robots We Like to Live with?! A Developmental Perspective on a Personalized, Life-long Robot Companion. In Robot and Human Interactive Communication, 2004. ROMAN. 13th IEEE International Workshop, IEEE, pp. 17-22

⁷⁷⁵ Kuffner, J. (2010) Cloud-Enabled Humanoid Robots. Humanoids2010 Workshop "What's Next". Google Research. The Robotics Institute, Carnegie Mellon University

⁷⁷⁶ Tucker M R et al (2015) op. cit.

Similar to what happens with applications on smart devices, mobile servant robots are subject to the data protection laws of the country, including non-European countries⁷⁷⁷. The “household exemption” seems not to apply in this scenario because all these data are transferred to a wide range of people (e.g. manufacturers, physicians, etc.) and would not be solely for household activities⁷⁷⁸.

As we have already seen, the General Data Protection Regulation binding in 2018 will toughen already well-known data protection principles (informed consent for instance) but will also introduce several new principles. These principles will be challenged by mobile servant robots that live with humans because the sporadic HRI they normally have in public spaces will turn into a relationship that is likely to be multi-modal as well as evolving over time with the user⁷⁷⁹. Awareness of the collected data, informed consent, and legitimate purpose are going to be challenged. How consent should be given for all the activities is also a matter of debate.

Google patented the use of cloud robotics to support future human-robot personalized relationships⁷⁸⁰. However, nothing has been written on whether that (and the future version of it) is compliant with the current legal systems in various countries and regions (*see* below). In particular, cloud robotics challenge the consent of the user, the veracity of the learned information (that can be sometimes from the Internet) and also the mass surveillance capacity that they have.

How does the robot of Mihaljo Pupin work? A. Rodić et al. explained that the robotic system (smart home, wearable devices and the robot) creates a 24/7 monitoring system which can outperform what a caregiver could do (*see* ethics section for the substitution of caregivers). The robotic system is fed by the unstructured data collected from the various sensors that compose the robotic system, including body and face gestures, speech, conversation, routines, habits, doctor’s appointment, credit card data, social network profiles, etc. and can come from different sources:

- From the user all the possible information regarding: personal calendar, email, text messages (or other electronic correspondence), call log, recently accessed documents on a computer, Internet browser history, DVR;
- From the user’s devices, including a computer, laptop, mobile phone, PDA, tablet, cellular or other mobile computing devices. Any other television or cloud computing devices, or any device with capacity to access the cloud, will also be considered as a user’s device. All of these devices could give relevant information about the user;
- From the environment, the robot’s sensors could collect information such as: the location, nearby objects, time of the day, weather, language, interaction with other robots;
- From other profiles the user might have on the Internet.

⁷⁷⁷ Moreno J.C. et al. (2014) op. cit.

⁷⁷⁸ Opinion 5/2009 on Online Social Networking. Article 29 Working Party. Available at: http://ec.europa.eu/justice/policies/privacy/docs/wpdocs/2009/wp163_en.pdf

⁷⁷⁹ Benyon and O. Mival (2010) From Human-Computer Interaction to Human-Companion Relationships, IITM’10, Allahabad, UP, India, ACM

⁷⁸⁰ Google, “Methods and systems for robot personality development”, U.S. Patent 8 996 429 B1, March 31, 2015

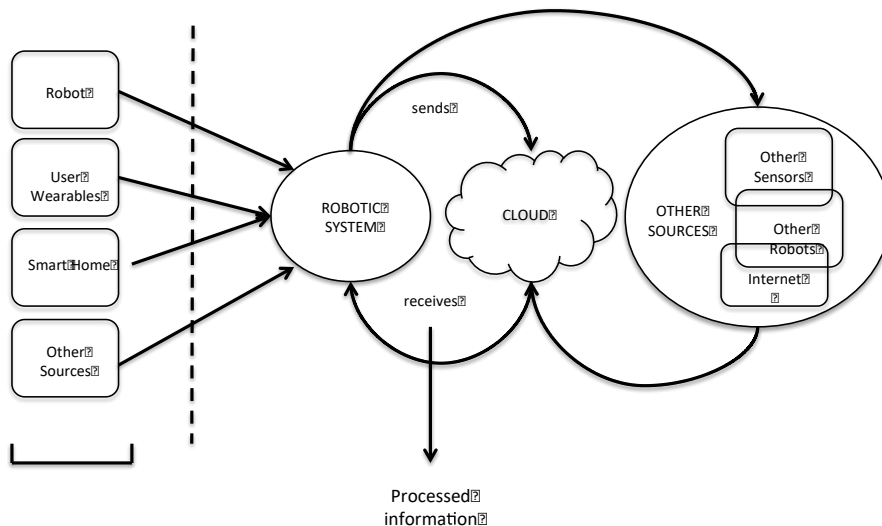

Figure 51 Robotic System data collection system and and Cloud interaction

The robot might send this unstructured data to the cloud and receive back processed data to customize that way the default personality of the robot. As we can see in Figure 12, the interaction could not only be between the user and the robot, but also between the robot and other sources such as other sensors, other robots or the internet itself. These latter interactions could be done directly, e.g. between robots; or indirectly, through the cloud. Indeed, it will be able to share information with other cloud computing devices. As Rodić et al. say, the efficiency of the system will depend on capacity of the cloud system, which should be able to enable fast and reliable communication amongst the system agents (robot(s), sensors, objects, human), processing and storing information, at risk to put the user in danger.

Privacy and security are on the top of the user’s major concerns. It is normal: “no one wants their personal data compromised and very few are interested in having it shared socially”⁷⁸¹. However, in elderly care, users need to be monitored in a greater manner than normal users. To protect the identity of the persons, some steps towards the creation of standards for anonymizing data have been taken⁷⁸². Nevertheless, the anonymisation of data does not involve per se the loss of the “personal” feature of personal data⁷⁸³. In fact, although some companies advocate that only scattered information is processed (normally to escape from the data protection legislation) Article 29 Working Party (A29WP) already warned that if “the processing of that information only makes sense if it allows identification of specific individuals and treat them in a certain way” it should be considered as information relating to identifiable individuals; adding that “large amount of data processed automatically [...] entails a

⁷⁸¹ PWC (2014) The Wearable Future. Consumer Intelligent Series. Available at: <http://www.pwc.com/us/en/technology/publications/assets/pwc-wearable-tech-design-oct-8th.pdf>

⁷⁸² Hamblen M. (2015) UL Creating a Standard for Wearable Privacy and Security. Computerworld. Available at: [/www.computerworld.com/article/2991331/security/ul-creating-standard-for-wearable-privacy-and-security.html](http://www.computerworld.com/article/2991331/security/ul-creating-standard-for-wearable-privacy-and-security.html)

⁷⁸³ Furthermore, although the identification of the user is at the core of the European data protection framework, the truth is that most of the times the companies are not interested in who is the person that does a certain action, but that a “consumer, female, 50 years old, has bought this” regardless if she is Maria or if she is Pepa.

risk of re-identification”⁷⁸⁴. The A29WP is talking about the Internet of things environment.

Although there is no general consensus on the definition, IoT refers to the “scenarios where network connectivity and computing capability extends to objects, sensors and everyday items not normally considered computers, allowing these devices to generate, exchange and consume data with minimal human intervention”⁷⁸⁵. The infrastructure of IoT challenges the current data protection legislative framework for several reasons. Here are the problems highlighted by the A29WP⁷⁸⁶:

- Lack of control and asymmetry: as the processing of the data involved in IoT environments relies on the coordinated intervention of several stakeholders, not only it will be difficult to establish the roles and responsibilities of data controller/processor, but it will also be hard to track the data flows that will be generated. This will entail a complete loss of control from the users as well as a self-exposure of all their data.
- Quality of the user’s consent. One of the major problems of IoT is the user’s awareness of which objects are processing data. Classical mechanisms to obtain consent might not apply in this context, as it could be practically impossible to ask for consent each time.
- Inferences derived from data and repurposing of original processing. Modern techniques allow secondary, not pre-specified uses of the collected data very easily, and processing such data with a new aim or for a new use should be considered according to the European Data Protection legal framework.
- Intrusive extraction of behavior patterns and profiling. As this technology is going to be part of the private life of the users (because the wheelchair is used in the nursing home), the possibility to extract behavioral analysis of the collected data now is for real, something which clashes with the principle of data minimization.
- Limitation in the possibility to remain anonymous when using services. Because the idea behind IoT is the personalization of the offered services, it will be very easy to identify the user of a particular technology.
- Security risks: security vs. efficiency. According to the A29WP, manufacturers need to balance the implementation of confidentiality, integrity and availability measures at all levels of processing.

IoT combines the possibility to process personal data and also large quantities of sensor data, which can be used further on in data fusion as the Mihaljo Pupin robot does. The main problem of data fusion is the use of data by third parties and, consequently, the loss of control over that data, both personal and non-personal and the unknown post behavioral analysis of this data⁷⁸⁷. A. Rodić et al. highlight that only authorized persons (members of family or medical team) have access to the information, and they are able to see either a weekly or monthly report based on the

⁷⁸⁴ Opinion 8/2014 on the on Recent Developments on the Internet of Things, Article 29 Working Party. Available at: ec.europa.eu/justice/data-protection/article-29/documentation/opinion-recommendation/files/2014/wp223_en.pdf

⁷⁸⁵ Rose, K., et al. (2015). The internet of things: An overview. The Internet Society (ISOC).

⁷⁸⁶ Article 29 Working Party (2014) Opinion 8/2014 on the on Recent Developments on the Internet of Things: ec.europa.eu/justice/data-protection/article-29/documentation/opinion-recommendation/files/2014/wp223_en.pdf

⁷⁸⁷ Howard, P. N. (2015). Pax Technica: How the Internet of things may set us free or lock us up. Yale University Press

collected data. The company itself is the one that should not have a continuous access to the collected data (*see* Fig. 65).

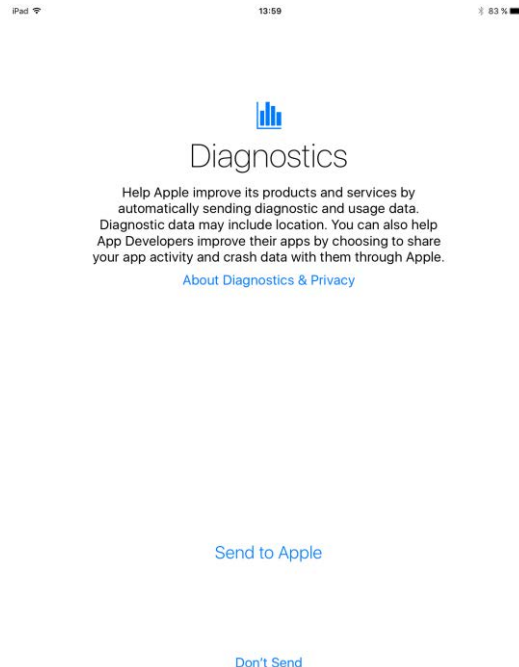

Figure 52 Picture taken from our iPad. Apple asks for data for their own purposes.

This should be banned. Companies like Apple ask in a very nice, simple form, the general consent to the user so that they can do whatever they want. And they do it in a very vague way so that they can use the data in the future with no problem. Furthermore, they say “may include location” but do not tell you what data are going to process. In fact, the translation of the responsibility to the data subject has allowed many of these companies to process all the information they want because 1) the user does not read the terms and conditions of the system; 2) because the user receives vague explanations of what they will do with their data – normally to improve the services they offer; 3) because the person is not conscious of the monetize value of this data. A paid-reward system could be established in order to compensate the users for their “donation”. Price and privacy has been studied in other cases⁷⁸⁸. Surprisingly, although valuations are not uniformly distributed, not only the price people assign to protect a price of information is very different from the price they assign to sell the same piece of information; they also know how much their privacy is worth, even if that value will depend on the context in which they are asked. Acquisti et al. argue that individuals are constantly making privacy-related decisions that affect people’s well-being and that this should be carefully addressed.

The principle of transparency should play a major role in this data usage. As the European Parliament suggests, the designers should ensure that maximal transparency

⁷⁸⁸ Acquisti, A., John, L. K., & Loewenstein, G. (2013). What is privacy worth?. *The Journal of Legal Studies*, 42(2), 249-274.

when programming robotic systems, as well as predictability of robotic behavior. Yet, the intrinsic labyrinthian structure of the data flow between devices, devices and back-end systems, providers and manufacturers, makes it practically impossible to track data. Tracking data is a key element for accounting reasons (e.g. black boxes) but the more the data collected, the more difficult it is to discover and track its flow⁷⁸⁹ (especially if there are different providers as the case scenario suggests).

For instance, Samsung Smart TV privacy policy reads⁷⁹⁰:

“Please note that when you watch a video or access applications or content provided by a third-party, that provider may collect or receive information about your SmartTV (e.g., its IP address and device identifiers), the requested transaction (e.g., your request to buy or rent the video), and your use of the application or service. Samsung is not responsible for these providers’ privacy or security practices. You should exercise caution and review the privacy statements applicable to the third-party websites and services you use”

This is just an example of how companies work: if the robot incorporates other applications (or it is used as an interface for using other applications as Jibo tries to do), then the company is not responsible for the privacy policies that these companies are complying with. Moreover, sometimes these companies do send data to third parties, as happened with Samsung and their Smart TV⁷⁹¹ :

If you enable Voice Recognition, you can interact with your Smart TV using your voice. To provide you the Voice Recognition feature, some interactive voice commands may be transmitted (along with information about your device, including device identifiers) to a third-party service provider (currently, Nuance Communications, Inc.) that converts your interactive voice commands to text and to the extent necessary to provide the Voice Recognition features to you. In addition, Samsung may collect and your device may capture voice commands and associated texts so that we can provide you with Voice Recognition features and evaluate and improve the features. Samsung will collect your interactive voice commands only when you make a specific search request to the Smart TV by clicking the activation button either on the remote control or on your screen and speaking into the microphone on the remote control

The problem is basically the user awareness: not only the user will not pay attention to the privacy policy (or to the whole possibilities of the robot’s characteristics), but the user might be so much used to this technology that he/she will not remember that this is capable of listening to every conversation, tracking any movement he/she does, etc.⁷⁹². There are also issues with the informed consent of the user: how can the user know if this is a good or a bad thing for him? But not only that, what if instead of an old person, we are transmitting the data that our children have (because it is a mobile servant robot destined to be working with a young child)? For example, a patient with moderate to severe dementia might find difficult to understand how to use fingerprint

⁷⁸⁹ Medaglia, C. M., and Serbanati, A. (2010). An overview of privacy and security issues in the internet of things. In *The Internet of Things* (pp. 389-395). Springer New York

⁷⁹⁰ See <http://www.samsung.com/uk/info/privacy-SmartTV.html>

⁷⁹¹ Read the story here: BBC (2015) op. cit.

⁷⁹² See Carrol, S. (2016) Goodbye privacy, hello 'Alexa': Amazon Echo, the home robot who hears it all: <https://www.theguardian.com/technology/2015/nov/21/amazon-echo-alexa-home-robot-privacy-cloud>

recognition biometrics for authentication purposes. These usage difficulties in the user, jointly with their frequent age-related technological illiteracy, may open breaches for illicit activities by third parties such as unauthorized authentication, or identity verification⁷⁹³. The privacy policy on the Hello Barbie website reads⁷⁹⁴.

We will not share the personal information we collect through the Services with third parties, except as described in this Policy. For example, we may share Recordings and other personal information as follows (subject to any applicable COPPA requirements or restrictions):

- with vendors, consultants, and other service providers ("Service Providers") who need access to such information to carry out their work for us, such as vendors who assist us in providing and maintaining the Services, in developing, testing and improving speech recognition technology and artificial intelligence algorithms or in conducting research and development or who otherwise provide support for the internal operations of the Services (e.g. if we use the Bing Voice Recognition API in connection with the Services to provide voice recognition services, Recordings and other performance data associated with the speech functionality will be sent to Microsoft);

- when you give us your consent to do so, including if we collect account related information from you and notify you that the information you provide will be shared in a particular manner and you provide such information;

when we believe in good faith that we are lawfully authorized or required to do so or that doing so is reasonably necessary or appropriate to (a) comply with any law or legal processes or respond to lawful requests or legal authorities, including responding to lawful subpoenas, warrants, or court orders; or (b) protect the rights, property, or safety of ToyTalk, our users, our employees, copyright owners, third parties or the public, to enforce or apply this Policy, our Terms of Use, or our other policies or agreements; and

- in connection with, or during negotiations of, any merger, sale of company assets, financing or acquisition, or in any other situation where personal information may be disclosed or transferred as one of the business assets of ToyTalk

We may also share aggregated or anonymized information that does not constitute personal information. For example, we may share analytics and other aggregate information about users' activities on our Services that do not contain any personal information with parties we partner with, such as Mattel.

- We will not share Recordings with Mattel. We may, however, share certain transcripts or other text derived from Recordings with Mattel, which will be used solely for the purpose of enabling Mattel to assist us in providing quality control and in improving and approving the scripting of Hello Barbie.

- Service Providers are not authorized to use any Recordings or other personal information they receive from us for their own purposes (e.g., for purposes not related to providing, maintaining, testing, developing or improving the services and technology being provided to ToyTalk). We may, however, share transcripts, text or "feature extracted data" that are created from the Recordings, but which no longer contain a child's voice, with Service Providers or other third parties, which they may use for their own research and development purposes, including developing, testing and improving speech recognition technology and artificial intelligence

⁷⁹³ Erevelles, S. et al. (2016) Big Data Consumer Analytics and the Transformation of Marketing. *Journal of Business Research* 69, pp. 897-904

⁷⁹⁴ See www.toytalk.com/hellobarbie/privacy/

algorithms not related to the services or technology being provided to ToyTalk. These Service Providers and other third parties (including Mattel) may not use any Recordings, feature extracted data, transcripts or any content contained therein to contact or advertise to children.

The major problem is that the “actual customers’ perceptions of the benefits are more influential than their concerns about the risks of wearable devices”⁷⁹⁵. This is caused by a disinformation on the actual risks: first, because providers are more interested in focusing on the benefits rather than on the risks; second, because there is a tendency in research on investigating the benefits of a certain technique or device rather than investigating its bad consequences; and third, because the costumers tend to compare the new device with other, more familiar devices (e.g. smartphones or tablets) although the latter might differ largely for hardware architecture or functionality. In the end, when people are not aware they do not know something, they think they do know⁷⁹⁶. That is why the principle of fairness that requires the awareness of the data subject to collect data lawfully, should mediate in any case. Failing to do so would make the processing unlawful and bring about consequences for the data controllers such as the duty to give compensation to the data subjects, or all the sanctions provided in the national legislations.

Concerning the quantity of collected information, in theory, the data minimization principle (derived from the principle of proportionality of the data processing) should mediate. However, on the one hand, big data techniques are widely available today which may make difficult the compliance with this system; and, on the other hand, the intention of data collectors might be in opposition to the principle: to process all the available data in the world⁷⁹⁷. All this information processed in data mining can turn into new surveillance options⁷⁹⁸, a surveillance that could cause a big brother scenario or anxiety (although there is no evidence yet at this regard⁷⁹⁹). Although there will be users that for their personal circumstances want to be monitored more often than others, obvious opt-out mechanisms (kill switches) that should be consistent with reasonable design objectives should be implemented, European Parliament dixit.

In any case, not only the data subjects need to be aware of the collected data, but they also need to give their consent, especially if sensitive data are at stake (as they are regulated more stringently). Informed consents have already some limitations, e.g. language, religious or false expectations⁸⁰⁰, and the problem becomes bigger when the interactions are delegated to the smart devices⁸⁰¹ as the collection of information is not perceptible to everyone. Concerning wearable devices, they are expected to be so small that they will “be totally invisible [...] so the user’s won’t even see it or feel it inside

⁷⁹⁵ Although this relates to wearable devices, it basically applies to any new technology. *See* Heetae Y. et al. (2016) op. cit.

⁷⁹⁶ Erevelles, S. et al. (2016) Big Data Consumer Analytics and the Transformation of Marketing. *Journal of Business Research* 69, pp. 897-904

⁷⁹⁷ Google’s mission for instance is to organize the world’s information and make it universally accessible and useful. Information available at: <https://www.google.com/about/company/>

⁷⁹⁸ Holler, J. et al. (2014). *From Machine-to-machine to the Internet of Things: Introduction to a New Age of Intelligence*. Academic Press

⁷⁹⁹ Becker, M. et al (2013) *Cyberpsychology, Behavior, and Social Networking*, 16(2) pp. 132-135. Available at: [online.liebertpub.com/doi/pdf/10.1089/cyber.2012.0291](https://doi.org/10.1089/cyber.2012.0291)

⁸⁰⁰ Nijhawan, L. P. et al. (2013) Informed Consent: Issues and Challenges. *J Adv Pharm Technol Res*, 4(3), pp. 134-144

⁸⁰¹ Information Commisisoner’s Office UK (2014) *Big Data and Data Protection*. Available at <https://ico.org.uk/media/for-organisations/documents/1541/big-data-and-data-protection.pdf>

the garment”⁸⁰² and this will completely change the paradigm of informed consent⁸⁰³. The problem is to ensure a meaningful consent in this ubiquitous technology paradigm⁸⁰⁴ where users cannot know how their information will be amalgamated or utilized in the future⁸⁰⁵ and they need anyway to give their explicit consent⁸⁰⁶.

This idea connects with the “specified, explicit and legitimate purpose”. There is an obligation for the data controller to extensively and explicitly describe why and for what purpose the data are being collected, especially if these data can have secondary uses. As the A29WP remarks, either for “raw, extracted or displayed” data, the controllers need to make sure that the used data is compatible with the original consent. If there is the intention to collect data for research, the controller not only needs declare it⁸⁰⁷, but he also needs to have the user consent and set down all the appropriate safeguards⁸⁰⁸.

Besides ameliorating the services of companies, the N=All analysis raises a major problem as it aims at finding hidden connections that could be possibly useful for future developments⁸⁰⁹. All the systems could be improved thanks to the processing of all this information that could not have never been possible before. However, “finding the correlation does not retrospectively justify obtaining the data in the first place”⁸¹⁰, especially if there has been no consent for that. Therefore, as the identification of the individual is no longer the only priority in this domain, the current European data protection framework will have to be re-considered. The European Parliament suggests introducing privacy by design features into the design of the robot so as to ensure that private information is kept secure and only used appropriately. However, nothing is said on the privacy-by-Design techniques that need to be used to ensure the compliance with this right. For instance, is the use of a programming language that protects privacy by design as Jeeves does, enough protection?⁸¹¹

Google’s patent on robot personalization includes the robot’s estimation of the user’s mood, which other robots are already doing⁸¹², including the one from Mihaljo Pupin (*see* Fig. 14). The idea is to evoke positive responses when the user feels sad, either computationally or locally if a mood recognition database has been provided to the robot⁸¹³. Until 2013 this was not still being considered in some part of the

⁸⁰² See <https://www.google.com/atap/project-jacquard/>

⁸⁰³ For more information, *see* M. Ienca and E. Fosch-Villaronga (2016) Privacy and Security Issues in Assistive Technologies for Dementia. In: Jotterand, F. et al. Assistive Technologies for Dementia. Oxford University Press. Forthcoming.

⁸⁰⁴ Office of the Privacy Commissioner of Canada (OPC) Guidance Documents (2012) Seizing Opportunity: Good Privacy Practices for Developing Mobile Apps. Available at: https://www.priv.gc.ca/information/pub/gd_app_201210_e.pdf

⁸⁰⁵ Office of the Privacy Commissioner of Canada (OPC) Guidance Documents (2014) Wearable Computing. Challenges and Opportunities for Privacy Protection. Available at: https://www.priv.gc.ca/information/research-recherche/2014/wc_201401_e.pdf

⁸⁰⁶ Opinion 15/2011 on the definition of consent , Article 29 Working Party. Available at: http://ec.europa.eu/justice/policies/privacy/docs/wpdocs/2011/wp187_en.pdf

⁸⁰⁷ As it happens in this case: proteus.com

⁸⁰⁸ Art. 6.1.b) of the EU Data Protection Directive: “further processing of data for historical, statistical or scientific purposes shall not be considered as incompatible provided that Member States provide appropriate safeguards”.

⁸⁰⁹ Mayer-Schönberger, V, and Cukier, K. (2013) Big data. A revolution that will transform how we live, work and think. John Murray

⁸¹⁰ Information Commissioner’s Office UK (2014) Big Data and Data Protection. Available at ico.org.uk/media/for-organisations/documents/1541/big-data-and-data-protection.pdf

⁸¹¹ More information at projects.csail.mit.edu/jeeves/

⁸¹² Look to the new emotional robot called “Pepper” from Aldebaran Softbank Group. See <http://www.aldebaran.com/en/a-robots/who-is-pepper>

⁸¹³ Google, “Methods and systems for robot personality development” Nonlinear resonant circuit devices (Patent style),” U.S. Patent 8 996 429 B1, March 31, 2015

literature⁸¹⁴. However, now that there is no discussion on the processing of emotional data, does it violate the user's privacy/data protection? How is modeled and protected the privacy of the user when the detection of the emotions is linked with the biomedical data from the user? Beyond the fact that the data is extremely sensitive, and that security will be of paramount importance, the possession of all the collected information challenges the data protection framework, in concrete, the proportionality and necessity principles: what is the amount of data needed to allow the robot to emotionally adapt? In fact, as infinite storage capabilities will be needed, a clash between the data minimization and the limitation storage principle will occur⁸¹⁵. Instead of translating human emotions into robots maybe it could be considered to implement emotional coordination: build up some mixed, human-robot, emotional ecologies, with affective co-evolution. Furthermore, the collection of data is dynamic and progressive, because the robot learns over time. Thus, the relationship between the human and the robot demands for a life-cycle protection. This includes a protection for future desired/undesired third-uses of data for which the user might not have given his/her consent as well as the protection by-default or by-design that the Data Protection Regulation announces. A dynamic consent system for personal care robots could be also considered, but there is no research at this regard⁸¹⁶.

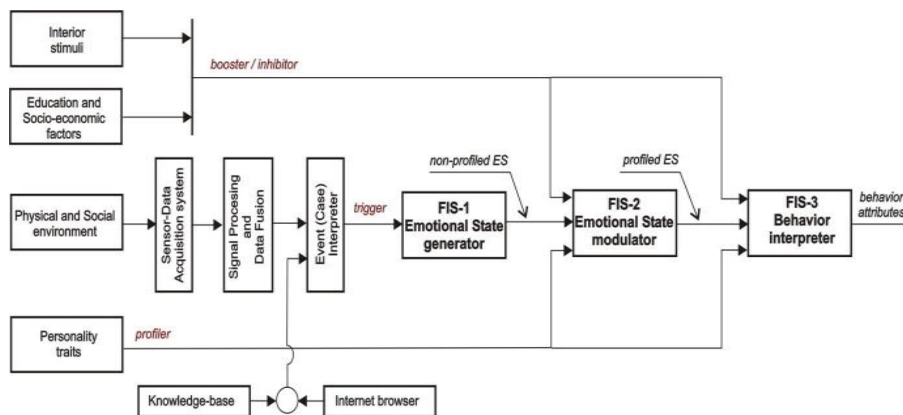

Figure 53 Emotion Based Model in Mihaljo Pupin Robot.

Related to this model, moreover, the patent of Google envisages the possibility of transferring the robot personality, through the cloud, to other robots (similar to the case scenario with the ExoKlass in the RoboGym). The very basic idea is based on the premise that “a remote-brained robot does not bring its own brain with the body. It leaves the brain in the mother environment, the environment in which the brain's

⁸¹⁴ Laukyte, M. (2013). Op. cit.

⁸¹⁵ Regulation (EU) 2016/679 of the European Parliament and of the Council of 27 April 2016 on the protection of natural persons with regard to the processing of personal data and on the free movement of such data, and repealing Directive 95/46/EC (General Data Protection Regulation)

⁸¹⁶ Some other initiatives concerning dynamic consent can be found at: Wee, R., Henaghan, M., & Winship, I. (2013). Ethics: Dynamic consent in the digital age of biology: online initiatives and regulatory considerations. *Journal of primary health care*, 5(4), 341-347. And Kaye, J., Whitley, E. A., Lund, D., Morrison, M., Teare, H., & Melham, K. (2015). Dynamic consent: a patient interface for twenty-first century research networks. *European Journal of Human Genetics*, 23(2), 141-146.

software is developed, and talks with it by wireless links”⁸¹⁷. That is why it is possible to transfer the personality from one robot to another if the user travels, because its “brain” lies on the cloud (its mother)⁸¹⁸.

This remote-brained idea is also the base for the data collection architecture. As what Klepic enounced “what happens in Vegas, stays in Vegas; what happens on Twitter stays on Google forever”, the collected information will remain on the cloud forever. The system to work properly needs to process and store all the information during the life of the device or the person. Some discussions have risen in the past few years concerning what happens when the person (the data subject) dies. Up to now, no provision regarding death can be found in Google’s term and conditions⁸¹⁹. Post-mortem privacy has been addressed by other platforms like Facebook⁸²⁰. In Europe, neither the Data Protection Directive 95/46/EC, nor the future proposal Data Protection General Regulation address this topic, even if there are some EU member states that have decided to cope with it⁸²¹. Surprisingly, in an opinion of 2007 the A29WP said that “information relating to dead individuals is (therefore) not to be considered as personal data”⁸²² even if there are other researchers that have a completely different opinion⁸²³. They also agreed on the fact that even if not considered personal data it “may still indirectly receive some protection” even if it is not clear what kind of protection. Indeed, as there are no guidelines around this topic, nor guidelines on other corpses that could be applied here. We do not know if the data that was collected from a particular user and his/her environment needs to be deleted once this person is dead or what would happen if a company wants to keep the data. Although it might seem creepy, the patent of Google Methods and systems for robot personality development that we have already mentioned, reports, “The robot may be programmed to take on the personality of real-world people [...] a deceased loved one”. In our opinion, the processing of this information shall be subject to the consent of the inherited person (as if the right to access data could be transferred once the person is dead).

As we can imagine, although in the other two cases we could also talk about privacy post mortem (and what companies do with the information they still have from the users, e.g. improving their devices), in the case of social robots this fact gains more importance. It is normal that there is no provision still in this regard because until very recently this could not be possible. What is surprising is that the Google patent is from 2015, and the General Data Protection Regulation was approved in 2016 (and it is going to be binding in 2018). If the European Union was already aware of the problems among privacy and deceased people (which have already arisen some concerns with Facebook profiles), why did not they include it into the new corpus?

⁸¹⁷ Ibana, M. (1997) Remote-brained Robots. Proceedings of the 15th International Joint Conference on Artificial Intelligence (IJCAI-97), 1997, pp. 1593-1606

⁸¹⁸ Of note, Ibana gave this explanation in 1997. To see more information about the patentability of the Google Patent, see Fosch-Villaronga, E. and Albo-Canals, J. Cloud-Robotics-Based ASD Research and the Google’s US 8,996,429 B1 Patent: Personality and Behavior [under review]

⁸¹⁹ See Google, Terms of Service, (last access 19th May 2015):

<http://www.google.com/intl/en/policies/terms/>

⁸²⁰ McCallig, D. “Facebook after Death: an Evolving Policy in a Social Network”. International Journal of Law and Information Technology, vol. 22, no. 2, 2014, pp. 107-140.

⁸²¹ In a recent successful case, Facebook claimed that as long as its headquarters would be in Ireland, the policies regarding data protection law compliance could apply to all other European Member States. For the Irish policy, a ‘data subject’ is only a ‘living individual’.

⁸²² Opinion 04/2007 ‘On the Concept of Personal Data’, Article 29 Data Protection Working Party, June 2007, pp. 22-23

⁸²³ Edwards, L., & Harbinja, E. (2013). Protecting post-mortem privacy: reconsidering the privacy interests of the deceased in a digital world.

The so-called “right to be forgotten” applies well here. This right reads:

The data subject shall have the right to obtain from the controller the erasure of personal data concerning him or her without undue delay and the controller shall have the obligation to erase personal data without undue delay where one of the following grounds applies: (a) the personal data are no longer necessary in relation to the purposes for which they were collected or otherwise processed; (b) the data subject withdraws consent on which the processing is based according to point (a) of Article 6(1), or point (a) of Article 9(2), and where there is no other legal ground for the processing; (c) the data subject objects to the processing pursuant to Article 21(1) and there are no overriding legitimate grounds for the processing, or the data subject objects to the processing pursuant to Article 21(2); (d) the personal data have been unlawfully processed; (e) the personal data have to be erased for compliance with a legal obligation in Union or Member State law to which the controller is subject; (f) the personal data have been collected in relation to the offer of information society services referred to in Article 8(1).” (art. 17 GDPR).

None of these a-f points mention any particularity concerning the death of a person. One might think that when “the personal data are no longer necessary” provision might be the one to apply in this particular case. However, the idea behind the patent of Google is to keep the information forever (as they are doing already) because otherwise there would be no possibility to talk back to deceased people. Is this ethical? (*see* ethical and dignity sections). If the GDPR enters in force, this principle will have to be met for any roboticist even if there is not that much bibliography at this respect on how this should be modeled or how it could be enforced from the main authorities. This, together with how machine learning algorithms work, challenge the right to be forgotten enormously⁸²⁴.

5.5. Autonomy

«John has mix feelings with the robot Albert brought him. One day he asked the robot to heat up some leftovers from the fridge. The robot said the leftovers where not good for his health and decided to cook something healthier. He prepared a healthy Vietnamese meal with lots of vegetables because it is healthier than using meat. The robot used peanut oil. John is allergic to peanuts and his glottis starts closing because of the peanuts. After that experience, John got very angry at the robot. The robot suggests John to take a relaxing pill to relax, because from the wearable devices the robot detects that his heartbeat is accelerated, he is tingling, his blood pressure is increased, and he has some heart palpitations. The robot puts some soft jazz music, turns the lights of the apartment into a nice warm environment, and tries to say to John “don’t worry John, everything is fine, to err is not only human”»⁸²⁵

⁸²⁴ Kieseberg, P.; Li, T. and Fosch-Villaronga, E. (2017) op. cit.

⁸²⁵ This is based on the Google patent op. cit.

Autonomy, independence as well as the free will of the elderly and disabled people are recognized in the UN Convention on the Rights of Persons with Disabilities⁸²⁶. As we have already seen, however, the RoboLaw project states that this autonomy should be interpreted differently in HRI scenarios. The project understands autonomy as “no longer a lack of dependence from others [...] rather it should mean the relational capability of a person to take care of his/her own forms of dependence”. Independence and free will, therefore, need to be carefully addressed and defined together with contexts, especially when the robot will have a role in the decision-making process (autonomously or tele-operated). This case scenario reflects an example of this fact. The patent of Google (op. cit.) states:

At block 826, the method 820 includes modifying the default user-profile to incorporate the estimated personality so as to provide a modified persona. This can be a transitory modification or something more permanent. For example, the robot may prepare food for the user using peanut oil. The user, who may be allergic to peanut-based foods, may eat the meal and have an allergic reaction. The user may further scold the robot for cooking the meal with peanut oil. Scolding may be considered a negative feedback response where the user is directing a negative reaction toward the robot for an action that the robot committed. On the other hand, a positive feedback response may be a positive reaction toward the robot for an action that the robot committed. In this example above, the robot may permanently modify information in the user-profile to include the user's allergic reaction to peanut and avoid anything to do with peanuts in the future

In this paragraph, the Patent argues that the robot can estimate the user's mood depending on the reactions to a certain scenarios. This estimation nevertheless can lead to a serious critical risk scenario. Food-induced anaphylaxis affects multiple organ systems⁸²⁷ and hospitalization due to it has increased over these years⁸²⁸. Even if the patent refers to a particular scenario, and wants to emphasize the fact that depending on the reactions the robot will be able to discover whether the user might like one thing or another thing (as a kind of reinforce learning), we feel that there has been an overtaking decision-making process from the robot. Independently of whether a robot can or cannot learn from the experience of the user, the actions autonomously taken by the robot should never endanger the safety of the user. Even if the robot might be in a learning process, there are several protective measures that should be embedded to avoid any unfortunate scenario. If the robot prepares the meal with peanut oil, the person suffers anaphylaxis, and then the system fails to call an ambulance, then not only the company would be responsible for an unwilling scenario, it will be responsible for the death of a person.

As suggested by Amodei et al. are clear “Systems that simply output a recommendation to human users, such as speech systems, typically have relatively limited potential to cause harm. By contrast, systems that exert direct control over the world, such as machines controlling industrial processes, can cause harms in a way

⁸²⁶ UN Convention on the Rights of Persons with Disabilities, Art. 3. Available at: www.un.org/disabilities/documents/convention/convoptprot-e.pdf

⁸²⁷ Hogan, S. P. et al. “Food-induced Anaphylaxis: Mast Cells as Modulators of Anaphylactic Severity”. *Semin Immunopathol* 34(5), 2012, pp. 643–653

⁸²⁸ Turner, P. J. et al. “Increase in Anaphylaxis-related Hospitalizations but no Increase in Fatalities: An analysis of United Kingdom National Anaphylaxis Data, 1992-2012”. *J Allergy Clin Immunol* 135(4), 2015, pp. 956–963.

that humans cannot necessarily correct or oversee”⁸²⁹. For instance, some actions happen continuously concerning our devices that overcome the autonomy of the users but the user is not aware of them. This is similar to a message that may appear on a smartphones (see Fig. 15) stating: “weather has been using your location in the background”. Why has this application been using location data in the background? Beyond the fact that the GDPR will include the privacy by design principle, in 2016 we are still controlled by-default and our privacy is given away by-default. This is a violation not only of the right to data protection, but also the right to the autonomy of the person. The problem is that the consequences of the violation of this right are not as seeable as they are in the previous allergic case scenario.

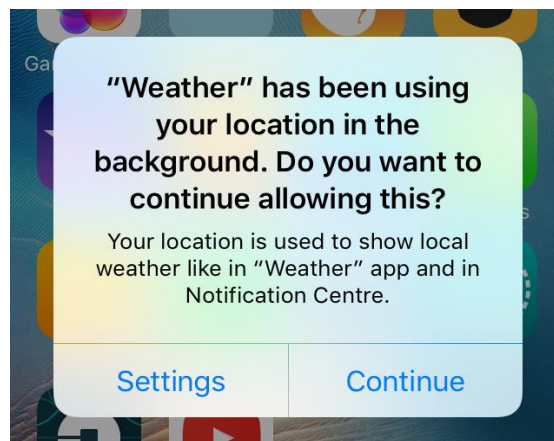

Figure 54 Displayed message by Apple after some days of using iPhone

Roboticians and developers should be aware of the fact that this constitutes a violation of other rights. Although it might not cause any physical harm (*prima facie*, we never know the case-by-case usage), it might cause a violation of another compelling right: the autonomy of a user to make own decisions in personal life.

Unfortunately, if we continue reading the patent of Google, Google wants the robot to take over in several situations. As an example, the patent reads “the robot may then adopt a persona of the user’s mother, and indicate ‘it is time to clean out the refrigerator, honey’”⁸³⁰. Delegating authority in the human decision-making process to a robot (i.e. giving away the autonomy of the user to the robot to autonomously decide on behalf him/her) calls for special attention, especially when the right not to be subject to a decision based solely on automated processing will be binding after the Art. 22 GDPR. Until now, there are practically no research groups addressing this type of autonomy delegation, especially when it involves the adoption of another person’s behavior and personality. The problem is when there is no consent for that. However, even with the consent, it should be verified if this consent can be considered legitimate for the autonomous decision-making process.

⁸²⁹ Amodei, D., et al. (2016) op. cit.

⁸³⁰ Google, “Methods and systems for robot personality development” Nonlinear resonant circuit devices (Patent style),” U.S. Patent 8 996 429 B1, March 31, 2015

In sociology, “one actor has authority over another [...] when the first holds the right to direct the actions of the second”⁸³¹. This could have an important role for the agent/agenthood concept by Floridi and Sanders: not only humans but also robots exhibit morally responsible behavior (because they are interactive, autonomous and are capable of changing transition rules to adapt themselves to the new situation⁸³²).

The problem of this agenthood, and the power that autonomy can give to the robot is a bit risky and could lead to an unforeseeable scenario. The robot might have the opportunity to improvise or extrapolate using clues from the humans interacting with the robot, or from surroundings and circumstances. In the patent of Google, an example is given: “the robot may respond to the negative reinforcement response by continuing to perform other tasks until a positive reinforcement response is received”. Although reinforcement learning could be a good solution for the appropriate evolution of the machine learning, the robot’s autonomous behavior should be limited. The robot cannot try different nuts until it realizes that the user is allergic to all nuts.

On the other side, the robot might have the possibility to remind the user to take a pill. If the robot is synchronized with wearables or if it has incorporated the capacity to scan the patient, then the robot might be able to discover whether the user has taken his medication or not. In the case he or she might not have taken the medication, should the robot autonomously decide to call the ambulance/doctor/family? For instance, A. Rodić et al. state that the “robot informs the patient that the medication is in the side net and he/she can take it over if capable of doing manipulation. If not, the robot puts a glass of water and drug pill on a tray and carries complete tray to the service user. While approaching the patient robot provides him with information that it brought him water and medicine”. Nevertheless, inducing humans to do some desirable actions could be interpreted as a strict violation of the intimacy and autonomy principles, and roboticists should very carefully address this. According to the Robolaw project, “by caring for physical and cognitive functions through technology, it is possible to free up resources that could be employed by people to enhance other individual and social capabilities”. However, how can a positive balance be achieved between both autonomies, the one from the robot and the one from the user, in this case?

Regarding autonomy, Laukyte wondered whether robots could be considered agents or not taking into account the capabilities approach developed by Nussbaum⁸³³. Laukyte defends that only having a look on robot capabilities, these are, self-driven motion, autonomous action, sensing capacity, multi-programmed and communication capabilities (among robots and among humans), we can already believe that they are more and more human-like. Although Nussbaum believes that only human capabilities count, she also states that “the capabilities of others are valuable as long as they promote and support human capabilities”. Therefore, it would make sense to consider personal care robots as agents because they are meant to perform actions contributing to the improvement in the quality of life of humans.

What it is interesting in her reasoning is the comparison of the capabilities approach to robots. She draws the following two charts:

⁸³¹ Coleman, J. S. (1994) *Foundations of Social Theory*. Harvard University Press. p. 66

⁸³² Floridi, L.; Sanders, J. W. “On the Morality of Artificial Agents”. *Minds and Machines* 14(3), 2004, pp. 349-379

⁸³³ Laukyte, M. op. cit. and Nussbaum, M. C. (2011). *Creating capabilities*. Harvard University Press.

No.	Capability	Which means that one is able to:
1.	Life	live a life of normal length.
2.	Bodily health	have good health.
3.	Bodily integrity	enjoy freedom of movement and decide on one's own reproductive matters.
4.	Senses, imagination, thought	freely use one's mind, cultivate it and express oneself through it; this includes education, free speech, artistic expression, etc.
5.	Emotions	nurture and develop one's emotional world, build such feelings as love, care, friendship, grief, gratitude, etc.
6.	Practical reason	build the notion of good and plan one's own life.
7.	Affiliation	engage in social interactions with other people and be respected as an equal member of society.
8.	Other species	live with and take care not only of people, but also of the vegetative world, fauna and the environment in general.
9.	Play	have fun, enjoy one's activities.
10.	Control over one's environment	participate in political life (the political environment) and own property, seek employment and work, be free from unwarranted search (material environment).

Table 1: Ten central capabilities (Nussbaum 2011).

No.	Capability	Which means that a robot is able to:
1.	Life	exist without being destroyed or broken for futile motives.
2.	Bodily health	have full maintenance and updates.
3.	Bodily integrity	have an existence without being subject to violence or any other type of harmful treatment.
4.	Senses, imagination, thought	Learn from experience.
5.	Emotions	_____
6.	Practical reason	have goals and plans for itself, behave rationally.
7.	Affiliation	function with and towards others (humans, animals, robots).
8.	Other species	relate to other species (humans, animals, robots).
9.	Play	_____
10.	Control over one's environment	_____

Table 4: Ten central capabilities applied to robots.

Table 10 On the left, ten central capabilities of Nussbaum; On the right, ten central robot capabilities

It is interesting how both entities could be much more similar. In this section, we have created a chart to complete the one by Laukyte in Table 18:

No.	Capability	Which means that the robot is able to (2016)
1.	Life	Switch on, battery life, die
2.	Bodily health	Maintenance and updates
3.	Bodily integrity	Protection against mistreatment
4.	Senses, imagination, thought	Sense-act-think, machine learning, creativity
5.	Emotions	Express and understand emotions. Empathy
6.	Practical Reason	Goals, self-learning, rational thought, decision-making process
7.	Affiliation	Social awareness, respected
8.	Other species	Live and take care of not only people but also of the vegetative world, fauna.
9.	Play	Companionship: elderly, children.
10.	Control Over one's environment	Decision-support systems

Table 11 Chart made by E. Fosch Villaronga based on M. Laukyte's work on the Nussbaum's capabilities approach for robots

In July 2016, a conference on Medical and Service Robotics was held in Austria and a paper on the European project subCULTron was presented⁸³⁴. As the website explains, subCULTron aims at achieving long-term autonomy in a learning, self-regulating, self-sustaining underwater society/culture of robots in Venice, Italy. By considering the goals of the project, we can understand the column of the right in Table 18. These objectives are⁸³⁵:

⁸³⁴ See <http://www.subcultron.eu>

⁸³⁵ For more information look at <http://www.subcultron.eu/project-description/> or see the press release at http://www.subcultron.eu/wp-content/uploads/2015/10/subCultron_presserelease_en.pdf

- Enable emergence and adaptation of the “individual being”;
- Enable emergence and adaptation of the “collective group being”;
- Provide minimum-requirement communication of beings;
- Establishing the “long-term being”;
- Survival through socialization;
- Novel bionic perception principles; Increasing public awareness, acceptance and interactions of “smart environments”.

The very basic idea is that their robots (artificial mussels, artificial fish and artificial pad (amussel, afish and apad as described in their project) are born and live with energy autonomy that dies once the battery is expired. Although it is true that mobile servant robots are not meant to die, because they are meant to be re-chargeable and long lasting, there are robots that already have this capacity⁸³⁶.

Concerning protection against mistreatment, as we already argued, although Teubner believes that we are the ones to be protected by electronic agents (and that animals are the ones to be taken care of)⁸³⁷, the success of the extension of legal rights to robots from Darling could make the future regulation of robots take into consideration a special protection against abuse and mistreatment for robotic technology⁸³⁸. The future Directive on the regulation of robotics will decide whether this should be taken into consideration or not.

The inclusion of machine learning and creativity in the “senses, imagination, thought” part is because current robot technology, especially artificial intelligence (that could be embodied into a robot) are creative. Computational creativity has developed for years and relates to the simulation or replication of creativity using a computer⁸³⁹. It is so advanced that an artificial intelligence system has been appointed as a new director of the creativity department in one company⁸⁴⁰. AI can create films⁸⁴¹, prepare cocktails and compose music⁸⁴² and now books⁸⁴³. Moreover, robotic learning capabilities could be a way of respecting user’s autonomy, i.e. if the robot learns from the user’s daily routine and takes it as a frame of reference for future scenarios⁸⁴⁴. The most important thing is to help users make the decision on what is best for the users⁸⁴⁵.

⁸³⁶ This is very similar to what Turing wondered, if machines could think, in Turing, A. M. (1950). Computing machinery and intelligence. *Mind*, 59(236), 433-460. The very basic idea of his work was that the machines could not *think* as we do, but that this word should have another meaning when referring to thinking machines.

⁸³⁷ Teubner, G. (2006). Rights of non- humans? Electronic agents and animals as new actors in politics and law. *Journal of Law and Society*, 33(4), 497-521.

⁸³⁸ Darling, K. (2016) op. cit.

⁸³⁹ Colton, S., & Wiggins, G. A. (2012, August). Computational creativity: The final frontier?. In *ECAI* (Vol. 12, pp. 21-26).

⁸⁴⁰

⁸⁴¹ See Diaz, C-A. (2016) Saatchi’s New Directors’ Showcase Features an A.I.-Created Film. In *Creativity*. See <http://creativity-online.com/work/saatchi-new-directors-showcase-anni-mathison-eclipse-behind-the-scenes/47918>

⁸⁴² Lazzaro, S. (2016) IBM Watson Has Learned to Make Cocktails and Compose Music. See <http://observer.com/2016/04/ibm-watson-has-learned-to-make-cocktails-and-compose-music/>. If you want to hear the Google’s song composed by its AI see <http://www.thedailybeast.com/videos/2016/06/02/the-song-google-s-robot-composed.html>

⁸⁴³ <http://observer.com/2016/04/dbrs-narrative-science-creative-ai/>

⁸⁴⁴ For instance, in order to avoid the anaphylaxis that we mentioned in the scenario (although we have already mentioned that the robot should avoid these scenarios beforehand and not having to wait until the allergic reaction happens). See Sorell, T. and Draper, H. (2014) Robot carers, ethics and older people. *Ethics Inf Technol* 16, pp. 183–195

⁸⁴⁵ Inspired by Khullar, D. (2016) Helping Patients Make the Right Decisions. *New York Times*, September.

The other aspect that is new in the chart is the capacity to express and understand emotions. Not only Pepper and other celebrity robots are working now at the emotional level⁸⁴⁶, there are other research groups trying to work on the emotional adaptation of the user, for instance the Mihaljo Pupin robot we described in this chapter or the robots used under the REHABIBOTICS project; a collaboration project between the Intelligent Robotics and Computer Vision Group (IRCV) at Rovira I Virgili University, Tarragona, Spain, and the Instituto de Robótica para la Dependencia, in Sitges, Spain, involving individuals with intellectual disability⁸⁴⁷. This emotional adaptation includes both the expression and the understanding of emotions from the robots. Whether the robot can actually understand an emotion has been largely studied, and even with very simple robots emotions can be expressed⁸⁴⁸. Although there are some researchers that think more social and emotional behavior could lead to a poorer perception of the social robot⁸⁴⁹, these are the current trend.

Another aspect to be remarked is the decision-making process in pragmatic situations: the robot will increasingly be involved in some decision making process that will lead the robot to some binary situations where the robot will have to react: act or not to act. That is why it will be so important to focus on social awareness, especially if we work with social robots that interact with humans in a cognitive layer. Mobile servant robots will go from proxemics, which includes speed, appearance and gaze direction; to a socially aware navigation, which includes not only proxemics theory but also comfort, semantics of space, behavior prediction, expectations or social conventions⁸⁵⁰. Furthermore, they will comprise empathy on their interactions⁸⁵¹, as it is a key aspect for human relationships⁸⁵². In fact, the more autonomous a robot is, such as multifunctional social assistive robots, the more it needs to be tuned in to values and norms⁸⁵³.

These robots are going to provide a sophisticated presence to the users and will provide them with companionship, which involves playing games (turn-taking games and others) as well as to entertain them. Independently of whether robots can or not have “fun”, they can be programmed to express comments towards it very easily.

Of note, in the future the increasing number of systems that control users’ environment, like all the NEST technology from Google⁸⁵⁴ or any smart home, will lead to an increase in decision-support systems. Such systems will also decide on the

⁸⁴⁶ See Dale, B. (2016) Humans 2.0: People and AI Will Probably Team Up. <http://observer.com/2016/03/sxsw-cyrcorp-narrativescience/>

⁸⁴⁷ Although they do not have a website yet, here you can find more information about the project: <http://duerer.usc.edu/pipermail/robotics-worldwide/2014-July/008344.html>. For some papers related to the project, see Shukla, J. et. al. (2015) A Case Study of Robot Interaction Among Individuals with Profound and Multiple Learning Disabilities. ICSR 2015, Springer International Publishing, pp. 613–622; and Shukla, J. et al. (2015) A Comparison of Robot Interaction with Tactile Gaming Console Stimulation in Clinical Applications. Second Iberian Robotics Conference: Advances in Robotics, Volume 2, Springer International Publishing, pp. 435–445.

⁸⁴⁸ Paiva, A., Leite, I., & Ribeiro, T. (2014). Emotion modeling for social robots. *The Oxford Handbook of Affective Computing*, 296.

⁸⁴⁹ Petisca, S. et al. (2015). More Social and Emotional Behaviour May Lead to Poorer Perceptions of a Social Robot. In *Social Robotics* (pp. 522-531). Springer International Publishing

⁸⁵⁰ Rios-Martinez, J. (2015) op. cit.

⁸⁵¹ Stephan, A. (2015) Empathy for Artificial Agents. *Int J Soc Robotics* 7, pp. 111-116

⁸⁵² Tisseron, S. et al. (2015) Testing Empathy with Robots: A Model in Four Dimensions and Sixteen Items. *Int J Soc Robotics* 7, pp. 97-102

⁸⁵³ Kuestenmacher A, Akhtar N, Plöger PG, Lakemeyer G. Towards robust task execution for domestic service robots. *J Intell Robot Syst* 2014;76(1):5.

⁸⁵⁴ See <https://nest.com/blog/category/technology/>

user's behalf. there is also the example of this robot hired as director, as there are other examples that have hired robots as employees⁸⁵⁵.

Autonomy has its downsides as well: autonomy straddles between user's autonomy and the delegation of his/her decision-making. Based on the available literature, there should be a balance between principles and, in any case, robots cannot undermine autonomy by turning into authoritarian robots⁸⁵⁶. Independence of the care-receiver needs therefore to be empowered⁸⁵⁷, and a sort of autonomy-by-design principle should mediate⁸⁵⁸.

To this regard, technical determinism that leads social robotics research should include social concerns (supra social awareness) and people acceptance⁸⁵⁹. Acceptance is very important. To date, there is a general prohibition of robots in the care of children, the elderly or the disabled⁸⁶⁰. Indeed, public attitudes towards care robots are still not very good. Yet acceptance seem to increase over time, and 29% of the robot contestants in 2012 would feel comfortable having a robot provide service to infirm people in 2015. Thus, there is a progressive and slow societal advance in accepting robots in care applications. Future research needs to focus on the reliability of these systems towards getting more acceptance⁸⁶¹.

Similar to what happens in Ambient Assisted Living Technologies, dependence could lead to a better acceptance ratio⁸⁶². However dependence on robotic technology, and especially when emotional/sensitive information is involved, could lead users to an emotional bond with uncertain consequences⁸⁶³. Although robots show reciprocity when responding to humans⁸⁶⁴, the robot's increased engagement is only fictional⁸⁶⁵: partly because of the intention of the creator, partly because of the effect of

⁸⁵⁵ Recent companies run merely by robot technology confirm these predictions (www.techinsider.io/companies-that-use-robots-instead-of-humans-2016-2). Spread is a Japanese vegetable factory that until now produced lettuces with the help of a small staff of humans. In 2017, because of the employment of robot technology that will substitute 50% of its staff, and because of vertical farming, Spread will be able to produce more, cut down on energy and recycle more water (spread.co.jp/en/). Going beyond what Yotel did with "Yobot" (a luggage-storing robot) (www.yotel.com/en), the hotel Hen-Na combines ambient technologies and robot staff that work as receptionists, cleaning personnel or gardeners for the sake of efficiency: although it has 72 rooms, the hotel only employs 10 people (www.h-n-h.jp/en/concept/). Any hotel could employ these robots as they are widely found on the market. Amazon is another well-known example: despite having around 150,000 employees, it has already beaten Walmart, the largest retailer in the world (that employs around 2 million human workers) (www.businessinsider.com/amazon-vs-wal-mart-in-one-chart-2015-7 and www.dailymail.co.uk/sciencetech/article-3172655/Amazon-overtakes-Walmart-firm-reveals-record-profits-causing-worth-rocket-250-billion.html), mainly because of the use of robot technology (www.cnet.com/news/meet-amazons-busiest-employee-the-kiva-robot/)

⁸⁵⁶ Sharkey, A., & Sharkey, N. (2010). Granny and the Robots: Ethical Issues in Robot Care for the Elderly. *Ethics and Information Technology*, 14(1), pp. 27–40

⁸⁵⁷ Van Wynsberghe, A. (2012) *Designing Robots with Care Creating a Framework for the Future Design and Implementation of Care Robots*. Doctoral Dissertation, University of Twente, Enschede

⁸⁵⁸ Millar, J. (2015) *Technological Moral Proxies and the Ethical Limits of Automating Decision-Making In Robotics and Artificial Intelligence*. Ph.D. Dissertation Queen's University, Ontario, Canada

⁸⁵⁹ Frennert, S. and Östlund B. (2014) Review: Seven Matters of Concern of Social Robots and Older People. *Int J of Soc Robotics* 6:299–310

⁸⁶⁰ See Special Eurobarometer 382 (2012) *Public Attitudes towards Robots*. See also Eurobarometer 427 (2015) *Autonomous Systems*, p. 30

⁸⁶¹ Robinson, H. et al. (2014). The Role of Healthcare Robots for Older People at Home: A Review. *International Journal of Social Robotics*, 6(4), pp. 575-591

⁸⁶² Dario, P. et al. (2014) *Ambient Assisted Living Roadmap*. AALIANCE2 Project Deliverable 2.7

⁸⁶³ See: www.nytimes.com/video/technology/100000003746796/the-family-dog.html?playlistId=100000003641597

⁸⁶⁴ Benitez-Sandoval, E. et al. (2015) Reciprocity in Human-Robot Interaction: A Quantitative Approach Through the Prisoner's Dilemma and the Ultimatum Game. *Int J of Soc Robotics* 1:15

⁸⁶⁵ Barco A, et al. (2014) Engagement based on a customization of an iPod-LEGO robot for a long- term interaction for an educational purpose. *ACM/IEEE HRI*, pp 124-125

anthropomorphization⁸⁶⁶, the user develops a true affection towards the robot. This unidirectional bond can lead to an emotional dependence on social robots. In some cases, the emotional bond can become overly strong⁸⁶⁷. This could lead users to be more easily manipulated. Moreover, is it possible that the robot understands the user more than their relatives or the doctor. Consequently, there might even be the risk that a user would feel that nobody can understand him/her more than the robot⁸⁶⁸.

5.6. Dignity

«After some time, John realizes that nobody comes to visit him. Albert that used to go every now and then, now takes advantage of the fact that the robot is so capable that he does not have to worry about anything. John's friends are not as techie as he is, and they do not have a robot nor use a lot of technologies to establish conversations. Even the visits to the doctor seem colder as they are now tele-visits. John not only starts feeling down, he also starts feeling weak, as the robot does everything for him. He is used to the robot so he does not do anything but watching television. He orders the robot a glass of water in the fridge. John changed the RFID tag and put it into a vase with poison. The robot brings him the poison, he drinks it and he dies»

The inclusion of care robots can decrease human care and by extent human contact⁸⁶⁹. The principle of dignity refers to the need to avoid isolation contexts caused by the insertion of robot technology. The implementation of robots seems however inevitable: it will not affect only few countries⁸⁷⁰ but the whole world⁸⁷¹. In fact, in 2013 some researchers tried to answer the question “how susceptible are jobs to computerization?”⁸⁷². They sustained that big data techniques could substitute non-routine cognitive tasks and that progress on robot dexterity would allow robots to increasingly perform manual tasks. The BBC released a software tool based on this study to know whether a current job was susceptible to be computerized or not⁸⁷³.

Although “it is not very likely” that care workers and home caregivers could be automatized, 40% of the tasks could be computerized (*see* Fig. 18). Furthermore, if we think about the capabilities of mobile servant robots, and if in 2016 we are thinking about commercializing robots with emotions, not only in care matters but also in other fields, then it is quite realistic that very soon home caregivers will be reduced⁸⁷⁴.

⁸⁶⁶ Darling, K. (2016) op. cit.

⁸⁶⁷ In the project of Barco, A. et al. (2014, August) op. cit., a girl cried when the robot was removed from the therapy.

⁸⁶⁸ Scheutz, M., et al. (2006). The utility of affect expression in natural language interactions in joint human-robot tasks. In Proceedings of the 1st ACM SIGCHI/SIGART conference on Human-robot interaction (pp. 226-233). ACM

⁸⁶⁹ Clark, R. A. et al. (2007) op. cit.

⁸⁷⁰ Japan's Robot Strategy 2015, see: www.meti.go.jp/english/press/2015/pdf/0123_01b.pdf

⁸⁷¹ Pistono, F. (2014). Op. cit.

⁸⁷² Frey, C. B. and Osborne, M. A. (2013) The Future of Employment: How Susceptible Are Jobs to Computerization? Retrieved September, 7. Available at: www.oxfordmartin.ox.ac.uk/downloads/academic/The_Future_of_Employment.pdf

⁸⁷³ BBC (2015) Will a Robot Take your Job? See: www.bbc.com/news/technology-34066941

⁸⁷⁴ SPARC that is the partnership for robotics in Europe to maintain and extend Europe's leadership in robotics and aims at making available European robots in factories, in the air, on land, under water, for agriculture, health, rescue services, and in many other applications (<http://sparc-robotics.eu/about/>). See the intentions of the European Union for robotics: <https://ec.europa.eu/digital-single-market/en/robotics> and also the H2020 projects concerning robotics: <https://ec.europa.eu/digital-single-market/en/news/h2020-robotics-projects-and-their-contribution-strategic-research-agenda>

Care workers and home carers

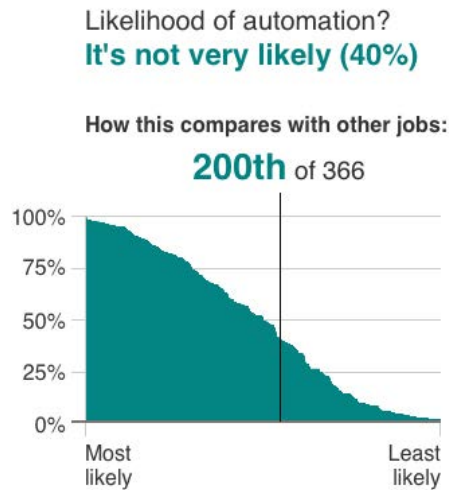

Figure 55 Search results of the BBC search engine for “care workers and home carers”

Socially assistive robot technologies could involve isolation because they provide sophisticated presence⁸⁷⁵. Indeed, the state of the art reveals that these robots are capable of performing lots of tasks (bathing, toileting, meal preparation, housework, shopping, monitoring, health management or companionship⁸⁷⁶) and according to the exponential growth theory, robots will more and more perform tasks hitherto unimaginable⁸⁷⁷. The computerization-job study concluded that “complex perception and manipulation tasks, creative intelligence tasks, and social intelligence tasks are unlikely to be substituted by computer capital over the next decade or two”, and as shown by the BBC application, “social workers, nurses, therapists and psychologists are among the least likely occupations to be taken over. In fact, assisting and caring for others involve empathy, which is a crucial part of the job”. Nevertheless, because of the fast advancing technology, even more sophisticated jobs might one day be done by robots.

The most important thing is to avoid the replacement of humans and of human feelings in social contexts. This can be done by promoting human-human interaction, empathy (either from the robot but also from the human perspective) but also including communication capabilities that could truly engage the person with the real world. This is crucial because for vulnerable parts of the society. Art. 19 b) of the UN Convention on the Rights of Persons with Disabilities reminds the general duty to promote dignity among care-receivers while minimizing exclusion contexts, enhancing social connectedness and encouraging care and human touch. This is what Sparrow and Sparrow argued in 2006, we cannot replace the human touch, and if we are working in

⁸⁷⁵ Sorell, T. and Heather D. (2014) Robot carers, ethics, and older people. *Ethics and Information Technology* 16.3, pp. 183-195

⁸⁷⁶ Mitzner, T.L. (2014) Identifying the Potential for Robotics to Assist Older Adults in Different Living Environments. *Int J soc Robotics* 5, pp. 379-388

⁸⁷⁷ Pistono, F. (2014) op. cit.

assistive technology they should be truly assistive and not “replace-ive”⁸⁷⁸. The right to human intervention that relates to data processing (Art. 22.3 GDPR) could reinforce this idea if enlarged to a more dignity dimension. One could think that, in the future, a person may have the right to choose between human or robot caregiver giving the possibility to a person to opt for a human caregiver instead.

In a more general context, but always on the replacement of the human factor in work environments, Pistono argued that poverty might not justify the existence of undignified jobs⁸⁷⁹. The question is: what is a dignified job and what is not? Who should be entitled to decide about these questions?

In work environment, assistive technology may not escape from being discriminatory. Although there are authors that believe that algorithms are not any less racist than humans⁸⁸⁰, there others believe that algorithms are quite discriminative⁸⁸¹. These algorithms run inside robots and have a wide range of implications: some examples are the higher income advertising for job seekers if the system believes that the person looking for a job is a male; or the same labeling for gorillas and black people under Google’s search engine; or also women discrimination, etc. If a future policy needs to address these systems, it should be done in a way to protect any discriminatory outcome. Even in the case of machine learning, like for instance the case of the Tay-Bot, this cannot happen under any circumstance⁸⁸². A simple apology from the companies is not enough, because these facts can cause a huge impact into the users’ life. Discrimination can come with other forms, like price discrimination and accessibility to the technology – in developing countries for instance.

Another fundamental aspect is the dignity of deceased people. As written on the Google patent, “the robot may be programmed to take on the personality of real-world people [...] a deceased loved one”. Whether this should be allowed or if the family should be entitled to delete all this information is still unclear. It is up to the society to decide what is the future that we want to have, as explained by De George⁸⁸³. Nevertheless, until now it seems that the industry goes first (with the release of ISO 13482:2014); then government interests come in second place, with a draft proposal on the regulation of robotics (Draft Report from the European Parliament); and finally the users’ interests come in the third place. As the technology progresses, the more and more we will have applications and technologies like PokemonGo⁸⁸⁴ that offers the users to see things that do not exist in this reality, which could be very challenging to the dignity of the humans.

A major question we often come across is whether mobile servant robots are actually going to improve the quality of life of users, as reported by ISO 13482:2014. Some of the advertising on robots are actually focusing on making consumers and users believe that robot technology is what can help with what they cannot right now:

⁸⁷⁸ We added this word. For the rest of information, *see* Sparrow, R., and Sparrow, L. (2006) In the hands of machines? The future of aged care. *Minds and Machines*, 16, pp. 141–161

⁸⁷⁹ In other words, Pistono, F. (2014) *op. cit.*

⁸⁸⁰ Leigh, A. (2016) Is an algorithm any less racist than a human? <https://www.theguardian.com/technology/2016/aug/03/algorithm-racist-human-employers-work>

⁸⁸¹ Miller, C. C. (2015) When Algorithms Discriminate: http://www.nytimes.com/2015/07/10/upshot/when-algorithms-discriminate.html?_r=1

⁸⁸² Vincent, J. (2016) Twitter taught Microsoft’s AI chatbot to be a racist asshole in less than a day. *See* www.theverge.com/2016/3/24/11297050/tay-microsoft-chatbot-racist

⁸⁸³ De George, R. T. (2008). *The ethics of information technology and business*. John Wiley & Sons

⁸⁸⁴ PokemonGo is a game developed in 2016 that has risen lots of concerns. *See* en.wikipedia.org/wiki/Pokémon_Go for more information of the game, and *see* Strauss, V. (2016) Pokemon Go sparks concern about children’s privacy. *The Washington Post*. www.washingtonpost.com/news/answer-sheet/wp/2016/07/19/pokemon-go-sparks-concern-about-childrens-privacy/

monitoring their beloved ones, take care of them, etc. However, whether this is dignifying and really helpful should better be addressed, as all current research seems to focus only on finding and promoting the benefits of robotic technology.

Vázquez M., et al. showed that a robot was able to deceive participants by taking advantage of its assumed superior abilities. The researchers clearly stated “it will be easy for roboticists to develop machines highly capable of persuasion through deception (or capable of coercing)”⁸⁸⁵. This inevitably raises ethical concerns and dignity questions. Of course people can also deceive people can coerce people, the problem is what happens when we allow machines to have this capabilities and we put them in care of our beloved ones.

Robots will increasingly have social awareness capabilities, and they will have to be more sensitive to personal thoughts and believes, like religion for instance. There is an actual Buddhist robot that chants mantras and answers questions about Buddhism⁸⁸⁶. In other religion contexts robots might not be that well-received, as it was highlighted by Zaghلامي in 2016⁸⁸⁷. This can play a major role for acceptance. Because of its high intimacy level, religion and robot technology should be carefully addressed to avoid user’s manipulation.

Talking about Buddhism, the NY Times published a video called “The Family Dog” that explained different stories around the Sony Aibo robot pet (dog)⁸⁸⁸. In the video it was explained that in Japanese culture everything have a soul. The documentary explained all the emotional bonds that people had with the robot dog, and how difficult it was for them to say goodbye to the dog, even if they knew it was just a robot. They had to find people that could repair them beyond the repairing service that Sony was offering, because Sony just decided stop producing it. In fact, it should be clarified what happen when the manufacturer would stop manufacturing robots. Data portability could be a possible solution to ensure that the data of a robot is not lost and can be implemented to a new robot. However, in the relationship with robot technology there is a more sophisticated part, a more esoteric aspect that cannot be quantified and is not tangible. The user develops feelings towards a precise robot.

A future policy concerning this robot technology should be capable of answering the question whether this technology is truly improving the quality of life, and that the dignity of the elderly and the users is respected to the maximum level. Otherwise, we might encounter several scenarios where physical HRI standards are not going to give value to all this other aspect which, in reality, have been found of most importance⁸⁸⁹. How is this policy going to be modeled with devices that are always on?⁸⁹⁰

5.7. Ethics

«As John complains a lot about the robot, his son Albert decides to remove it from his father’s house. Nevertheless, John finds a way to be ok with the robot and he does not want to give it away. “I don’t want

⁸⁸⁵ Vázquez, M., et al., op. cit. p. 210.

⁸⁸⁶ Sherwood, H. (2016) Robot monk to spread Buddhist wisdom to the digital generation. Available at: www.theguardian.com/world/2016/apr/26/robot-monk-to-spread-buddhist-wisdom-to-the-digital-generation

⁸⁸⁷ Zaghلامي, L. (2016) How Religious Beliefs Deal with Robotization. New Friends 2016, Conference Proceedings. Ethical, Legal and Societal Issues of Robots in Therapy and Education Workshop.

⁸⁸⁸ See <http://www.nytimes.com/video/technology/10000003746796/the-family-dog.html>

⁸⁸⁹ UN Convention on the Rights of Persons with Disabilities op. cit.

⁸⁹⁰ See Carrol, S. (2016) Goodbye privacy, hello 'Alexa': Amazon Echo, the home robot who hears it all: <https://www.theguardian.com/technology/2015/nov/21/amazon-echo-alexa-home-robot-privacy-cloud>. See also web.mit.edu/sturkle/www/Always-on%20Always-on-you_The%20Tethered%20Self_ST.pdf

you to take it away from me” – says John; “Why?” – asks Albert;
 “Because he is my friend” – answers John»

In this section we will deal with robots and ethics. In particular, we will discuss whether it is ethical that a robot uses biomedical emotions, we will go into the right approach for moral dilemma related to robots, and we will try to define how all this has an impact on the human-human interaction.

As reported by Salem et al., the risks associated with personal care robots can also have ethical implications. This is because there will be a shift from the sporadic human-robot interaction (which will happen in train stations or in museums, where the HRI will be very low, and the information to give to the user will be very concrete) to a human-robot safe interaction (because there will be applied standards on robot’s spatial behavior in response to human presence, robot’s noise level for robots in human environment, perception for HRI, Generic and High-Priority commands for HRI, Gestures across different cultures, etc.), and then to a relationship when they will end up in personal environment (*see* Fig. 19). This relationship will evolve over time; there will be a social and emotional investment; the robot will have some sort of personality that will follow the user’s preferences; the robot will be intelligent and multimodal; and robot application stores to download new applications or new functions will increase. The most important thing is that, in order to act and live in the human being world, “they have to be learning machines”⁸⁹¹.

In some cases, caregivers organizations however do not envision social assistive robots in social interactions scenarios such as giving the gentle touch of a hand, the warmth of a hug or the understanding of a conflict⁸⁹². They are partly right. As mobile servant robots aim at creating affective meaningful relationships with their users⁸⁹³, and relationships are “long-term built up over time through many interactions” as well as “social, emotional, persistent and personalized”⁸⁹⁴, the shift from interaction to relationship will require reciprocity, trustworthiness, empathy, social awareness and, of course, a way to promote a better human-human interaction⁸⁹⁵.

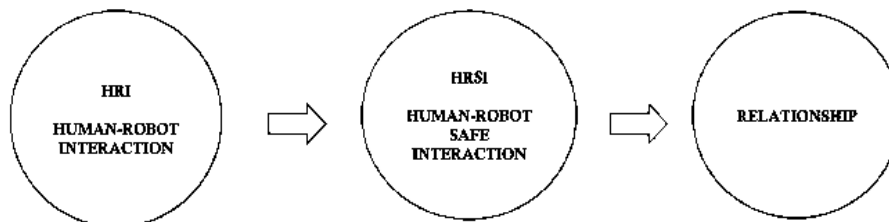

⁸⁹¹ Steinert, S. (2014). The Five Robots—A Taxonomy for Roboethics. *International Journal of Social Robotics*, 6(2), pp. 249-260.

⁸⁹² Wolbring G. et al (2014) Social Robots: Views of Staff of a Disability Service Organization, *Int J of Soc Robotics* 6, pp. 457–468

⁸⁹³ Collins, E. C. et al. (2015). *Op. cit.* See also McColl, D. et al. (2015). A Survey of Autonomous Human Affect Detection Methods for Social Robots Engaged in Natural HRI. *Journal of Intelligent & Robotic Systems*, 1-33

⁸⁹⁴ D. Benyon and O. Mival (2010) *op. cit.*

⁸⁹⁵ For reciprocity, *see* Benitez-Sandoval, E. et al. (2015) *op. cit.* For the empathy, *see* Lim, A., and Okuno, H. G. (2015). A recipe for empathy. *IJSR*, 7(1), 35-49. For the Trustworthiness, *see* Salem M. et al. *Op. cit.*; and for the sociability, *see* Baddoura, R., & Venture, G. (2015). This Robot is Sociable: Close-up on the Gestures and Measured Motion of a Human Responding to a Proactive Robot. *IJSR*, 7(4), 489-496.

Figure 56 Human-Robot Interaction evolution via adoption of in Mobile Servant Robots

Socially assistive robots will increasingly raise ethical questions as long as they will be co-habiting with humans. One of the problems that next generation of robots will face is the complete understanding of the human's needs. Robot empathy is a growing discipline that aims at increasing the knowledge of the human nature, as empathy is part of the human social structure⁸⁹⁶. This could help to achieve an empathic response from the user's perspective and gain more acceptance⁸⁹⁷.

Ethical dilemmas will come into play and empathy will have a major role in understanding the user's needs and willingness, and in establishing what should be the appropriate response and if robot creators need to solve the ethical dilemmas⁸⁹⁸. Semi-autonomy could sort some problems out, but not all the users will be capable of intervening at the appropriate times⁸⁹⁹, and neither will be third users involved in this relationship: doctors, nurses, relatives, etc.

This is going to be more complicated when socially assistive robots, based on the biomedical data of the user concerning his/her emotions will make recommendations on what to do in each case – even if only in rudimentary way such as “if you feel down, talk to a friend, it will help” (see Fig. 20). The more autonomous the decision-making process will be, the more difficult will be to apply the strict liability rules of the EU Parliament. Moreover, it should be elucidated if allowing robots to make decisions based on the biometric, biomedical data of the user is really ethical, or if this can create risks and thus limits should be set⁹⁰⁰.

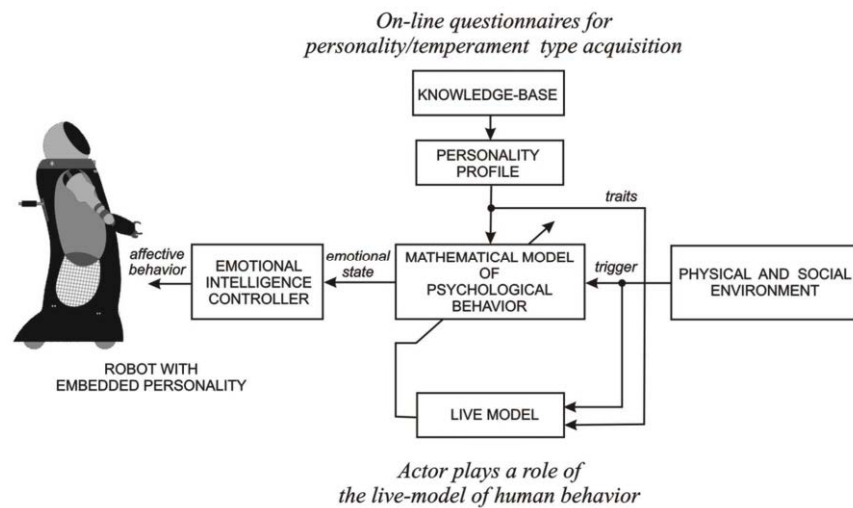

⁸⁹⁶ Tisseron, S. et al. (2015) Testing Empathy with Robots: A Model in Four Dimensions and Sixteen Items. Int J of Soc Robotics (2015) 7, pp. 97-102

⁸⁹⁷ Kwak, S. S. et al. (2013) What Makes People Empathize with an Emotional Robot? The Impact of Agency and Physical Embodiment on Human Empathy for a Robot. International Symposium on Robot and Human Interactive Communication, Korea

⁸⁹⁸ Sandel, M. J. (2010). Justice: What's The Right Thing To Do? Macmillan

⁸⁹⁹ Mast M et al (2015) Semi-Autonomous Domestic Service Robots: Evaluation of a User Interface for Remote Manipulation and Navigation With Focus on Effects of Stereoscopic Display, Int J of Soc Robotics 7, pp. 183–202

⁹⁰⁰ Norton, H. and Massaro, T. (2016) op. cit.

Figure 57 Embedded personality to the Robot of Mihajlo Pupin Institute

It is uncertain to what extent the creators of social robots have the duty to incorporate features in their design process that go beyond mere technical features – as the “BS 8611:2016 Robots and robotic devices. Guide to the ethical design and application of robots and robotic systems” suggests. In other words, are industrial standard bodies legitimate enough to introduce such obligations for the robot creator when they are voluntarily adopted?⁹⁰¹ Standards are good instruments to deal with complex, new and international issues; however, they do not have binding force. Should those who design, use and control these kinds of robots also be required moral agency and emotions⁹⁰²? As the European Parliament states, the European Union could play an essential role in establishing basic ethical principles for the development, programming and use of robots and AI, and in the incorporation of such principles into European regulations and codes of conduct, to avoid potential pitfalls as far as possible⁹⁰³. This is important independently of the type of robot, be it either vacuum cleaners or military robots⁹⁰⁴.

It is also essential that users understand that they cannot treat other humans in the real world like they treat their robots. Indeed, mobile servant robots could promote slavery-related behavior among users⁹⁰⁵. In fact, there are researchers that state that robots should be considered slaves and not companion peers⁹⁰⁶. This could have lots of implications, such as perceiving robots as slaves were agents in Roman ages⁹⁰⁷. However, this kind of behavior cannot be acceptable when it comes to other humans. As Richardsson argues⁹⁰⁸, most of the people in Europe and in North America might think that slavery is practically invisible when, in reality, the United Nations estimate that around 21 million people are currently victims of slavery⁹⁰⁹. Some slave-like treatments can be found with robots: recent cases of children beating up a robot in a mall were recorded, and that is what we are referring to here⁹¹⁰. As far as the study was concerned, the creators ideated an abuse escape algorithm to force the robot escape the abuse going to another direction, and finding an adult around them. These cases of

⁹⁰¹ Casey, D., & Scott, C. (2011). The crystallization of regulatory norms. *JLS*, 38(1), 76-95

⁹⁰² Coeckelbergh, M. (2010). Op. cit.

⁹⁰³ Extracted literally from the European Parliament Resolution op. cit.

⁹⁰⁴ Among other projects, the founders of this project have been working on military robots too, as stated by Singer, P. W. (2009). *Wired for war: The robotics revolution and conflict in the 21st century*. Penguin; and as we can see in <http://www.irobot.com/About-iRobot/Company-Information/History.aspx>

⁹⁰⁵ See the video recorded at the World Science Festival 2016: Moral Maths of Robots: Can Life and Death Decisions Be Coded? livestream.com/WorldScienceFestival/events/5415962/videos/125144136

⁹⁰⁶ Bryson, J. J. (2010). Robots should be slaves. *Close Engagements with Artificial Companions: Key social, psychological, ethical and design issues*, 63-74.

⁹⁰⁷ Coeckelbergh, M. (2013) op. cit. and also Coeckelbergh, M. (2015) The tragedy of the master: automation, vulnerability, and distance. *Ethics of Information Technology*, (2015), 17:219-229 and Pagallo, U. (2013). Op. cit.

⁹⁰⁸ Although the author refers to it in order to articulate his argument on sex robots, we found it very interesting as there is not that much literature at this regard. See Richardson, K. (2016). Sex Robot Matters: Slavery, the Prostituted, and the Rights of Machines. *IEEE Technology and Society Magazine*, 35(2), 46-53.

⁹⁰⁹ International Labour Organization (2016) SDG Alliance 8.7 - Joining forces globally to end child labour, forced labour, modern slavery and human trafficking. Accessed 9 August 2016 www.ilo.org/wcmsp5/groups/public/---ed_norm/---declaration/documents/publication/wcms_450718.pdf

⁹¹⁰ Brscic, D., Kidokoro, H., Suehiro, Y., & Kanda, T. (2015, March). Escaping from Children's Abuse of Social Robots. In *Proceedings of the Tenth Annual ACM/IEEE International Conference on Human-Robot Interaction* (pp. 59-66). ACM.

“robot mistreatments” by children can lead us to question whether humans have a tendency to mistreat robots, as suggested by Darling⁹¹¹.

This is a bit in opposition to other research studies that found that children⁹¹², and elderly treat robots as if they were friends and companions⁹¹³. As we can imagine, there is a mixed approach towards robot, and it is not very clear how a policy should model it. Maybe the robots should receive greater protection when they are outside of the users’ personal environment (regardless if a user owns them or not) or maybe children should be educated in order to respect outdoors property, whether they are moving or not. Other researchers have investigated what could happen when we teach the robot to be able to say “no” in certain situations. This could be very useful to avoid slavery scenarios because the robot could have the possibility to say no (and say “I am not going to buy illegal drugs John” for instance)⁹¹⁴.

In this relationship between the human and the robot, there are different opinions on whether it is ethical to befriend robots. From the one side, Sparrow and Sparrow express their concerns⁹¹⁵, De Graaf on the contrary believes that “as long as the user perceives to be served well by a robot and is satisfied with the behavior of that robot, there should not be a problem in this account”⁹¹⁶. However, her discourse is a bit dangerous when she affirms “it seems nothing is intrinsically wrong with human–robot relationships as long as we can develop robotic systems that effectively deliver what user’s believe to be appropriate care behavior”. Such a statement may be dangerous because this could imply that 1) robot creators should develop thousands of different kinds of care because each user is different; 2) the “appropriate behavior” for one person can be totally disgusting or shameful for another person, and the use of cloud robotics and machine learning are not going to help in this regard. A thorough, investigation should be conducted some sort of practical guidelines should be provided with the support of society, policy-makers and relevant stakeholders.

When we were talking about safety, we asked the question: what if the robot choses the wrong decision? The big problem that robotics is facing is the binary output in the decision-making process: act or not to act, respond or ought-not-to-respond, these are the questions. This is connected with the highly sensationalistic journal title “would you buy a care that might choose to kill you?” Maybe the progress on quantum computing will be able to solve all these issues.

⁹¹¹ Darling, K. (2015) Children Beating Up Robot Inspires New Escape Maneuver System. *See* <http://spectrum.ieee.org/automaton/robotics/artificial-intelligence/children-beating-up-robot>

⁹¹² *See* different papers on the topic: Kanda, T., et al. (2004) Interactive robots as social partners and peer tutors for children: A field trial. *Human-Computer Interaction*. 19, 1, 61–84; Kahn, P.H., et al. (2012). Robovie, you’ll have to go into the closet now: Children’s social and moral relationships with a humanoid robot. *Developmental Psychology*. 48, 2, 303. . *See* also Kory Westlund, J. and Breazeal, C. 2015. The interplay of robot language level with children’s language learning during storytelling. *Proceedings of the 2015 ACM/IEEE International Conference on Human-Robot Interaction - Extended Abstracts* (Portland, OR).

⁹¹³ Reppou, S., & Karagiannis, G. (2015) Robots and seniors: can they be friends? Workshop on the Legal, Ethical and Social Issues for Social Robots in Therapy and Education at Newfriends2015 Conference, Almere, The Netherlands.

⁹¹⁴ *See* some article s concerning this topic: <http://www.zmescience.com/research/technology/teaching-robot-say-no-0543/>; and <http://www.dailymail.co.uk/sciencetech/article-3334786/Uh-oh-Robots-learning-DISOBEY-humans-Humanoid-machine-says-no-instructions-thinks-hurt.html>

⁹¹⁵ Sparrow R, Sparrow L (2006) In the hands of machines? The future of aged care. *Mind Mach* 16:141–161

⁹¹⁶ de Graaf, M. M. (2016). An Ethical Evaluation of Human–Robot Relationships. *International Journal of Social Robotics*, 1-10.

5.8. Justice

As we have already mentioned, the basic pillars of the principle of justice are the access to this technology, either in opportunities or in cost. The European Parliament stated that “researchers in the field of robotics should commit themselves to the highest ethical and professional conduct and abide to the principles of beneficence, non-maleficence, autonomy and justice”. According to it, justice refers to the fair distribution of the benefits associated with robotics and affordability of homecare and healthcare robots in particular.

Some initiatives to make this technology available are underway. The researcher Sophie Sakka has started an initiative called “Rob’Autisme” in Nantes, France⁹¹⁷. Although this might not be non-medical personal care robots, it is an example of how research can really serve those in need. The *raison d’être* of their project is admirable: broadcast a robotic-based protocol to improve the communication skills of people within the autism spectrum disorder; establish a national network for exchanging and sharing discussion between all stakeholders affected by autism (associations, parents, schools, etc.); and open and short-term workshops applying the protocol to all people with autism in region Pays de la Loire⁹¹⁸.

If they prove their efficiency, initiatives like this one will lead this technology to become available to the general population.

6. Summary of mobile servant robots analysis

Here we introduce a summary of all the risk scenarios or recommendations that we have found along our research in social robot technology that can be useful from the policy perspective (and the consequent protection of the users) but also for roboticists to better understand the rights that need to be protected.

Task-oriented
user-oriented
social interaction

CONTEXT	
Risks	Recommendations
Place	Specific requirements for home care, especially if it includes a smart home, wearable devices and a robot
	Specific requirement for the type of architecture/environment: cloud, IoT
	Even if unstructured, a degree of structured-ness is desired for the system to work efficiently.
Users	Specific requirements: special attention to elderly, children and disabled people

⁹¹⁷ See more information at www.association-robots.com/?page_id=611

⁹¹⁸ Original text: diffuser un protocole à base de robots et destiné à améliorer les capacités de communication de personnes souffrant de troubles autistiques ; établir un réseau national pour l’échange et la discussion entre tous les intervenants concernés par l’autisme (CHU, associations, parents, établissements scolaires, etc.) ; et ouvrir à court terme des ateliers appliquant le protocole à toutes les personnes souffrant de troubles autistiques en région Pays-de-la-Loire.

Robot	CRIA should be developed prior the insertion of the robot into the premises of the house
	Different safeguards depending on the technology applied to it, the robot's capabilities and the HRI
	Special attention to cognitive HRI
	Clarity on the type of robot and the regulation that applies to it
CRIA	Identify the internal/external stakeholders

SAFETY	
Risks	Recommendations
General	The robot needs to be safe at all the instances of its tasks performance
Silent operations	For the lack of awareness hazard concerning silent operations, a regulable voice volume should be implemented
Cognitive HRI	Use of a cognitive advanced dialog generation software (CADGS) that generates and adapts instructions to users depending on their cognitive abilities
	Complement the CADGS with the Folstein or Bristol ADL test
	Work on the creation of common guidelines among roboticists at this CADGS regard.
	As the robot imitates the ways humans interact with other humans, robots will have to posses a basic knowledge of the social norms of humans
	If the robot designer could apply some team mental models to the robot , the resulting behavior could be predictable, adaptable and easily understood by humans
Environmental Hazards	Concerning the environmental hazards, if a robot is going to be working in a kitchen, in a personal environment or that it will be operated for long periods of time between the maintenance inspections, then special attention should be drawn to the high level of dust.
	If the robot is intended to be working outside, then other environmental hazards might apply
	The robot need to be able to learn from the environment
	Although extreme temperatures might refer to the temperature of the robot, as the robot will be in the kitchen, it is important that the robot is prepared to touch hot surfaces (the stove) or cold surfaces (the freezer) with its robotic arms (other meaning of extreme temperatures)
Robotic Arm	If the robot arm is "industrial quality" it should be compliant with the regulations on industrial robot
	If the robot arm is industrial but incorporates sensitive actions, e.g. feeding function, special safeguards should be taken place.
	Guidelines for the feeding function with the robotic arm should be written: type of allowed cutlery, what movements are allowed, etc.

	if the plate that comes out of the microwave is very hot, the robot should be capable of saying it so or inform the user by any means, and leave the plate in a place where it cannot hurt the user, e.g. on the table (not giving it to him)
Electromagnetic	If the robot user incorporates medical implants or devices, it is important that SAR do not emit harmful levels of electromagnetic interference
Posture	All the hazards concerning posture and usage hazards might not apply in this case, as the physical HRI is practically non-existent
User Interface	The user interface should be truly user-centered
Contact	The information in the user interface should be adapted according to the end-user target needs otherwise the usability might be at risk. This should be done in a way that the user does not feel discomforted because he/she does not understand the robot.
	Contact shall be detected along the entire robot structure for HRI
Navigation (physical and social)	Special attention to the following robot motion hazards: travel instability, instability in collision, instability while carrying objects (in the pockets of the robot for instance), or detachment of the body parts after collision
	The design of the stability of the personal care robot to ensure that it does not fall, rollover or overturn within the intended environmental conditions specified for the robot. The robot should be programmed in a way that is able to detect all these aspects first in order not to fall, but second, in order to protect the user from harming himself
	Special attention to obstacle avoidance as the objects might be closer distance than in person carriers
	Modeling difference over other aspects in the environment could be a good solution to avoid unfortunate scenarios. Instead of modeling “perform task X” it would be better to include “perform task X but avoid side effects to the extent possible”
	Although some of these robots might include path-planning capabilities, it is important that the robot incorporates also a map of the building that could detect glass walls and other obstacles that might constraint the mobility of the device
	To do this, an impact regularizer could be defined; if not, this impact regularizer could be learnt, and a sort of penalization model concerning influence could be installed into the system. In other words, limiting the robot to go somewhere because it can be the cause of a side-effect could be a good idea even if the intentions of the robot might not be mean
	Cooperative inverse reinforcement learning could be helpful to understand what other agents want and act upon
	As people have a stronger reaction when robots invade their personal space than compared with humans, robot motion will have to be studied from the proxemics perspective, that is, to address the appropriate negotiation of personal and shared space between the human and the robot

	As proxemics is based on environment and on cultural aspects, this is going to be of special important in social robots because cultural aspects need to be taken into account when designing the HRI
	The designers of the robot need to make the robot in a way that its behavior is legible by the user, regardless of the degree of impairment the user has and will have to ensure that robots are identifiable as robots when interacting with humans
	Proxemics will need to be complemented with social awareness. A socially-aware navigation is the strategy exhibited by a social robot which identifies and follows social conventions (in terms of management of space) in order to preserve a comfortable interaction with humans
	Because mobile servant robots will not only communicate but play a role in their user's emotional life, it will be crucial to know how the robot should approximate to the human physically and in terms of shared space, but also cognitively, in social terms
	Use of empathy is advised.
Legal Compliance	The designer of the robot should ensure that his/her robot operates in a way that is in accordance with local, national and international ethical and legal principles
	Robot designers should consider and respect people's physical wellbeing, safety, health and rights. A robotics engineer must preserve human wellbeing, while also respecting human rights, and disclose promptly factors that might endanger the public or the environment
Uncertainty	The designer of the robot should analyze the predictability of the human-robot system by considering uncertainty in interpretation
	In safety matters, not only is important to reduce the risk, but also to reduce the uncertainty
Decision-Support Systems	There might be the need to create automatic decision-support systems in order to help the user decision-making process
User commands	The robot should be designed in a way that understands natural language. Special attention should be done in bilingual communities, with a dialect, etc.
	Speech recognition in voice-commanded robots is of fundamental importance.
	The robot need to recognize whether the voice command is for it or for another person (if there is more than one person in the room)
	There should be perfect the notion of "obligation to respond" in mobile servant robots
	The robot need to know how to avoid erroneously responding to noises, monologues or utterances from other participants
	The use of dialogue-related features for instance, using dialogue status, timing information could help these issues
	A system that could detect robot-directed utterances could be good in order to solve this problem

	One solution could be to integrate a recognition confidence in the robotic system combined with visual information, like face direction or behavioral information
Machine Learning in the robot	Instead of controlling the hazard, inherent safety design tries to eliminate the hazard from the system (achieving robustness instead of uncertainty). If the system is unknowingly biased so that only using deep neuronal techniques accuracy could be achieved
	Multiply safety reserves, that is, safety factors and safety margins
	The third system is very similar to the protective stop, that is, that the system remains safe when the system fails
	Reinforcing audits, trainings and posted warnings (this goes in line with the creation of the European Robot Agency)
	The use of reinforce learning could help improve machine learning safety and also the ethical decision-making process
Embedded harm	As those who know what pain means get injured less than does that know it, it could be considered harm to be programmable and embedded into the robot to protect the safety of the user
	The robot should be programmed so that it understands that the user is in pain, so as to help him/her; or that it is itself in pain, in order to protect itself
	According to the advancement in the state of the art, psychological harm is desirable to be programmed and embedded into the robotic systems so that the robot can act upon.
Award Hacking	Concerning reward hacking, the system could be designed in a way that the robot might never understand how the reward is generated, so that it can be very difficult to hack it
	Multiple rewards would be also difficult to hack
	What has been called careful engineering could be useful, as well as installing trip wires, meaning that the creator of the robot could be noticed if the system tries to hack the reward system
CONSUMER ROBOTICS	
Risks	Recommendations
Misleading representations	Avoid the use of videos of the robot that do not match with the actual capacities of the robot
	Convincing people that robots can do certain activities that are not true should be a banning practice
	A person should buy a robot for what it is, e.g. a medical device if it incorporates medical device functions. Attention should be done to mixing categories.
Deception	Try to reduce the deception in HRI
	Establish what level of deception is permitted and under what circumstances
	Establish clearly whether the robot is a medical device or not.
Perceived Safety	It is crucial for the efficient performance of the device that the user trusts the robots and this robots presents as safe to the person

	Concerning cognitive safety issues, social assistive technologies need to demonstrate that they are trustworthy. Trust plays a central role in this type of technology because the user needs to accept the commands provided by the robot
	The robot needs to present itself to the user as safe in physical terms, that is, that the human will not be hurt by the robot
	Trust needs to be built upon the reliability of the robot's behavior, which might involve not only physical activities (such as bringing a glass of water to the person) but also to the non-physical activities, such as different purchases and transactions done through the robot (because the user has created a shopping list with the help of the robot and the robot sends the command to the nearest supermarket), but also intellectual activities done with the user (collaborative tasks, playing games, entertaining, the person needs to be sure that the robot will play chess and will not throw away the pieces because he lost, for instance).
	The designers of the robot should promote trust in the robot's intentions. The robot should not deceive the user sending, for instance, health information to the general practitioner without the person's knowledge
	Designers should introduce trustworthy system design principles across all aspects of a robot's operation, for both hardware and software design, and for any data processing on or off the platform for security purposes
legal transactions	Safeguards for internet purchases such as consent of the user, the limit on the credit card, a double check with the relatives or the doctor, etc., should be implemented
	Clarifying important issues such as the identification of the contract parties and the whether the system has the capacity to perform the contract is thus crucial
LIABILITY	
Risks	Recommendations
Reversibility	Incorporation of a 3-level robotic system: physical, network and application level
	The actions of the robot should be reversible. Reversibility means aiming at being a necessary condition of controllability that tells the robot which actions are reversible and how to reverse them if they are
	Reversibility could help model liability
Non-Reversibility scenarios	Avoid between-the-devil-and-the-blue-sea scenarios
	If the robot encounters a between-the-devil-and-the-blue-sea-scenario, the robot will have to choose the lesser of two evils, and prepare remedies for the other part
Liability	Main institutions will have to decide when the strict liability regime will mediate
	The designer is the one that has probably specified wrongly the objective function

	<p>Ignorance of other aspects of the environment that might be 1) important and 2) susceptible to change, can lead also to wrong objective functions</p> <p>Reward hacking (for reinforcement learning) could also pervert the intentions of the designer</p> <p>The designer might have designed safely the objective functions but the universe of data is insufficient or poorly curate training data</p> <p>Some of the objective functions can be very expensive that for the lack of economical means, these cannot be achieved therefore leading to unfortunate scenarios</p> <p>The robot should be able to differentiate between legal and illegal purchases (even of a product that might be at the same time legal/illegal in other countries)</p>
Precaution	<p>Precautionary principle should be applied during the research phase of the project, the creation of the robot and also along the implementation of it.</p> <p>The roboticists will have to predict future bad consequences of their creations in order to avoid a butterfly effect.</p> <p>Because of that, designers of the robot should develop tracing tools that could be used to facilitate accounting and explanation of robotic behavior</p> <p>The robot should be prepared to explain what it did.</p> <p>The legal framework should be embedded into the robot in order to act upon</p>
Responsibility of the teacher	<p>It might not be applicable in cloud robotics environments</p> <p>It needs to be clear who is the creator and who is the teacher of the robot; and assign responsibilities</p> <p>Explain the consequences of the robot teacher, assign responsibilities</p>
Responsibility of the third	<p>It needs to be clear that the third person that decides on behalf of the robot (in case of doubt) will have or not part of the liability.</p> <p>If this third is another robot, responsibility framework should be modeled accordingly</p>
Accountability	<p>Designers should design and evaluation protocols and join with potential users and stakeholders when evaluating the benefits and risks of robotics, including cognitive, psychological and environmental ones</p> <p>Robotics engineers should remain accountable for the social, environmental and human health impacts that robotics may impose on present and future generations</p> <p>The use of Care Robot Impact Assessment will help model accountability and transparency matters</p>
General Policy	<p>A dynamic responsibility framework (if not a general framework) could adapt itself to the harm caused, in concrete, and model the framework from it taking into account all the differences of the system that need to be taken into account should be the appropriate response in order to allocate responsibility for future robot technology.</p>

USER RIGHTS	
Risks	Recommendations
Data Security	Ensure that the robot does not have any virus
	The anonymisation of data does not involve per se the loss of the “personal” on personal data
	Large amount of data processed automatically entails a risk of re-identification, therefore, especial attention should be drawn to IoT environments
	For example, a patient with moderate to severe dementia might find difficult to understand how to use fingerprint recognition biometrics for authentication purposes. These usage difficulties in the user, jointly with their frequent age-related technological illiteracy, may open breaches for illicit activities by third parties such as unauthorized authentication, or identity verification. This should be controlled
Collection of information	The collection of data process should be outlined and clarified identifying collecting sensors, cloud and other feeding data sources
	Although it might seem utopic, the data minimization principle (derived from the principle of proportionality of the data processing) should mediate in any case
Consent	A dynamic consent should be preferred. It should be taken into account the users sanity.
	The translation of the responsibility to the data subject has done that, in the end, lots of these companies can process all the information they want because 1) the user does not read the terms and conditions of the system; 2) because the user is not explained what they will do with their data; 3) because the person is not conscious of the monetize value of this data. A paid-reward system could be established in order to compensate the users for their “donation”.
	The ideal is to ensure a meaningful consent in this ubiquitous technology paradigm where users cannot know how their information will be amalgamated or utilized in the future
Cloud	The efficiency of the system will depend on capacity of the cloud system, which should be able to enable fast and reliable communication amongst the system agents (robot(s), sensors, objects, human), processing and storing information, at risk to put the user in danger
IoT	Lack of control and asymmetry. The loss of control from the user as well as a self-exposure of all his/her data should be avoided
	Classical mechanisms to obtain consent might not apply in this context, as it could be practically impossible to ask for consent each time. A dynamic consent model should be established
	Modern techniques allow secondary, not pre-specified uses of the collected data very easily, and processing such data with a

	<p>new aim or for a new use. If there is no consent for this secondary used, this practice should be banned.</p> <p>Intrusive extraction of behavior patterns and profiling should be avoided</p>
Access	<p>The rights of access and control over this data should be established carefully on the agreement between the data controller and the data subject.</p> <p>Access to certain people will have to be granted in order the system to work efficiently, e.g. relatives, doctors, etc. This should be carefully managed.</p> <p>Future access of the company to the device should be limited</p>
Transparency	<p>The principle of transparency should play a major role in this data usage</p> <p>Tracking data is a key element for accounting reasons (e.g. black boxes) but the more the data collected, the more difficult it is to discover and track its flow. If there are different providers, all the providers should provide the same amount of transparency</p>
Awareness	<p>As the major problem is that actual customers' perceptions of the benefits are more influential than are their concerns about the risks, producers of this technology should make users aware of their weaknesses.</p> <p>The principle of fairness that requires the awareness of the data subject to collect data lawfully, should mediate in any case</p> <p>Transparency should play a major role on user awareness of the collected data</p>
Surveillance	<p>All this information processed in data mining can turn into new surveillance options, a surveillance that could cause a big brother scenario or anxiety. Special attention should be drawn to this regard.</p>
Opt-in	<p>Obvious opt-out mechanisms (kill switches) that should be consistent with reasonable design objectives should be implemented</p>
Purpose	<p>There is an obligation for the data controller to extensively and explicitly describe why and for what purpose the data are being collected, especially if these data can have secondary uses</p>
Data Mining	<p>Because finding the correlation does not retrospectively justify obtaining the data in the first place, data mining should have to be carefully addressed according to the data protection principles</p>
Emotional Data	<p>Special attention to the robot processing emotional data, as this type of data has not been very often collected before</p> <p>The link between emotional data and biometrical data should be carefully used as it can lead to unfortunate scenarios</p>
Life-cycle protection	<p>Similar to a seed that turns into a tree, which is not a tree when it is a seed, and it is not a seed when it is a tree, the relationship between the human and the robot demands for a life-cycle protection</p>

Privacy post mortem	In 2007, information relating to dead individuals is (therefore) not to be considered as personal data. However, the processing of this information shall be subject to the consent of the inherited person.
	Information on this topic will help create guidelines on it
	The right to be forgotten should be implemented but there is the need for more guidelines on it so as to know how the roboticists should proceed
by-design	More guidelines at this regard on how this could be implemented are needed
AUTONOMY	
Risks	Recommendations
General	Autonomy, independence as well as the free will of the elderly and disabled people are recognized in the UN Convention on the Rights of Persons with Disabilities and should be respected by roboticists
	A balance between the autonomy of the robot and the autonomy of the user should be provided
	Systems that simply output a recommendation to human users, such as speech systems, typically have relatively limited potential to cause harm. By contrast, systems that exert direct control over the world, such as machines controlling industrial processes, can cause harms in a way that humans cannot necessarily correct or oversee. Attention should be drawn to this second type of robotic systems
Decision-Support Systems	There might be the need to create automatic decision-support systems in order to help the user decision-making process
	Attention should be drawn to the "finish task" function in certain robotic systems
Autonomous decision-making process of the robot	None of the actions that the robot autonomously decide to do can endanger the safety of the user
	Even if the robot might be in a learning process, there are several protective measures that should be embedded into the robot in order to avoid any unfortunate scenario
	Violations on the data protection right might be a violation of the right to autonomy of the user
	Data protection violation constitutes a violation of other rights, that might not cause any physical harm (prima facie, we never know the case-by-case usage) but that might incur on a violation of another compelling right, the autonomy of a user to decide on his/her personal life choices
	Delegating authority in the human decision-making process to a robot (i.e. giving away the autonomy of the user to the robot to autonomously decide on behalf him/her), nevertheless, calls for special attention
	In sociology it is said that one actor has authority over another when the first holds the right to direct the actions of the second. If the first is a robot, this calls for special attention

	The following statement "the robot may respond to the negative reinforcement response by continuing to perform other tasks until a positive reinforcement response is received" needs to be carefully considered as not only the autonomy but also the health of the person might be at stake with this reinforce learning
	As the state-of-the-art progresses, the more projects will aim at achieving long-term autonomy in a learning, self-regulating, self-sustaining society/culture of robots. Special attention should be drawn to that.
	Emotional adaptation per the user's mood should be carefully addressed
	Semi-autonomy could sort some problems out, but not all the users will be capable of intervening at the appropriate times , and neither will be able to do so the third users involved in this relationship: doctors, nurses, relatives
User autonomy	The literature agrees that there should be a balance between principles and, in any case, robots cannot undermine autonomy by turning into authoritarian robots
	Independence of the care-receiver needs therefore to be empowered
	A sort of autonomy-by-design principle should mediate
	Dependence on robotic technology, and especially when emotional/sensitive information is involved could lead users to a better acceptance rate, but also to an emotional bond, whose consequences need to be addressed
	Semi-autonomy could sort some problems out, but not all the users will be capable of intervening at the appropriate times , and neither will be able to do so the third users involved in this relationship: doctors, nurses, relatives
	The right not to be subject to a decision based solely on automated processing will be enforceable by the GDPR and will have to be reconsidered in the case of assistive technology
DIGNITY	
Risks	Recommendations
Isolation	The inclusion of care robots can decrease human care and by extent human contact, so communication capabilities should be implemented among others
	There is the need to avoid isolation contexts caused by the insertion of robot technology
Substitution of caregiver	Although it is not very likely that care workers and home carers are not going to be automatized, the truth is that scientific data states that this kind of job is 40% likely to be computerized
	The most important thing is to avoid the replacement of humans and of human feelings in social contexts
	This can be done by promoting human-human interaction, empathy (either from the robot but also from the human perspective) but also to include communication capabilities that could truly engage the person with the real world

	<p>In medical care, there is the general duty to promote dignity among care-receivers while minimizing exclusion contexts, enhancing social connectedness and encouraging care and human touch</p> <p>Human touch cannot be replaced, and that if we are working in assistive technology this technology should be truly assistive and not replace-ive</p> <p>The right to human intervention (Art. 22.3 GDPR) could be applicable to the case of robot technology.</p>
Discrimination	<p>This assistive technology should avoid any discrimination context</p> <p>Any algorithm can produce any discriminatory outcome</p> <p>In front a discrimination scenario provoked by an algorithm running within the robot, an apology will not be enough to award damages</p> <p>Price discrimination should also be avoided.</p>
Deceased people	<p>Being able to talk with deceased people does not seem a dignifying task worth being incorporated by a robot</p>
Quality of life	<p>There is the need to justify why the robot is actually improving the quality of care of the person, and this is linked to the precautionary principle and to the accountability for the present/future generations</p>
Emotional bonds	<p>Attention should be drawn to the emotional bonds that the users will create with this technology.</p> <p>If the robot stops being produced, it should be necessary to model how to deal with the expectations of the user, their right to data portability.</p>
ETHICS	
Risks	Recommendations
Ethics	<p>The European Union could play an essential role in establishing basic ethical principles to be respected in the development, programming and use of robots and AI and in the incorporation of such principles into European regulations and codes of conduct, with the aim of shaping the technological revolution so that it serves humanity and so that the benefits of advanced robotics and AI are broadly shared, while as far as possible avoiding potential pitfalls</p> <p>In order for artificial moral agents to act and live in the human being world, “they have to be learning machines</p> <p>The shift from interaction to relationship will require reciprocity, trustworthiness, empathy, social awareness and, of course, a way to promote a better human-human interaction</p> <p>Robot empathy is a growing discipline that aims at increasing the knowledge of the human nature, as empathy is part of the human social structure . This could help to achieve an empathic response from the user’s perspective and gain more acceptance</p> <p>It is uncertain to what extent the creators of social robots have the duty to incorporate features in their design process that go</p>

	beyond mere technical features until there is no binding legislation at this regard.
	Those who design, use and control these kinds of robots also be required moral agency and emotions
	Avoid users to translate the way they behave with robot technology to the real world
	Considering robots as slaves could have the implication to 1) grant them agenthood; 2) start applying these behaviors in real world. This should be avoided.
	Teaching the robot to say "no" might have to be considered to avoid spoilt behaviors from the users that could badly influence the real world.
	As the technology advances, the use of quantum computing will be preferable as much more data will be able to be processed and maybe more than just a simple binary
JUSTICE	
Risks	Recommendations
Access	Low-cost technology
	Access programs to the benefits of this technology
	Right to benefit from it

Table 12 List of possible controls for socially assistive robots (mobile servant robots sub-type)

5. Chapter - Considerations for Lawmakers: Areas of Interest or Concern and Possible Issues and Challenges

Solving The World's Biggest Problems Takes Ensembles, Not Soloists. Jeffrey Walker.

1. General considerations

The current regulatory framework does not include a specific legislation for personal care robots. Many may think there is no need for a new framework for this type of technology. Others may believe that a simple update of certain provisions in the existing regulation can be enough. Yet, based on the considerations in this thesis, having guidelines on the legal aspects involved in care technology is fundamental because of the high and close HRI, and the context of use of these devices. Personal care robots might take different forms, may perform different actions and might lead to impacts and risks not always possible to foresee or mitigate in time. Because roboticists want to be compliant with existing laws (and need to be aware of what are the aspects they need to take into account) but also because users have rights that cannot be undermined by the mere benefit of this technology, this technology requires close attention from regulators and policymakers. This is even of greater importance when vulnerable parts of the society are the direct users of such technologies.

To date, there are still no guidelines on healthcare robots even the particular context of use, the vulnerability of the users involved and the great differences between devices. Neither the Consumers, Health and Food Executive Agency (Chafea) that implements the EU Health Programme,⁹¹⁹ or the DG Connect AI & Robotics commented on this topic. The main focus of technology seems to be drone technology, autonomous cars and lately industrial robots, and the main topics concern security and future of work. Of note, healthcare robotics have not received much attention yet. In fact, the latest resolution of the European parliament does not mention therapeutic (physical or cognitive) robots, nor educational robots. And when it comes to describe the concerns of “care robots” they focus mainly on how the human factor needs to remain into the caregiver-carereceiver relationship so as not to undermine one of the fundamental aspects of care:

Care robots

1. Underlines that elder care robot research and development has, in time, become more mainstream and cheaper, producing products with greater functionality and broader consumer acceptance; notes the wide range of applications of such technologies providing prevention, assistance, monitoring, stimulation, and companionship to elderly people and people with disabilities as well as to people suffering from dementia, cognitive disorders, or memory loss;
2. Points out that human contact is one of the fundamental aspects of human care; believes that replacing the human factor with robots could dehumanise caring practices, on the other hand, recognises that robots could perform automated care

⁹¹⁹ See their website ec.europa.eu/chafea/

tasks and could facilitate the work of care assistants, while augmenting human care and making the rehabilitation process more targeted, thereby enabling medical staff and caregivers to devote more time to diagnosis and better planned treatment options; stresses that despite the potential of robotics to enhance the mobility and integration of people with disabilities and elderly people, humans will still be needed in caregiving and will continue to provide an important source of social interaction that is not fully

This paragraph was shorter in the draft report in May 2016, which only pointed out that “human contact is one of the fundamental aspects of human care; believes that replacing the human factor with robots could dehumanize caring practices”. After some consultation with different committees⁹²⁰, the section on care robots was slightly enlarged. After conducting the analysis of the person carrier, physical assistant and mobile servant robots in the previous chapters, we can draw some comments:

- 1) First of all, there are two assumptions: that elderly and disabled people are accompanied, and that robots replace that (human) companion. In reality, not only the capabilities of robots are far behind the capacity of replacing an entire human (maybe some of the tasks), the cruel truth is that elderly might not be surrounded by people when they are in need – either sporadically (in the precise moment of a fall for instance) or permanently (they might not have family).
- 2) Second, there is an assumption that humans might be the best assistance for the users. In a workshop in Zurich during February 2017⁹²¹, the audience commented why programs like the Humanitas Deventer were no longer promoted more, instead of employing robot technology. That program allows students to live with senior for free in exchange of some “good neighbor” hours⁹²². Some commented that students might not have nursing skills or may feel overwhelmed in the case of an accident, whereas the robot could directly call an ambulance in such situation⁹²³.
- 3) Third, that there are robot technologies that are focusing on how we can use social robots as peer mediators and achieve greater human-human interaction, in some neurodevelopmental disorders for instance⁹²⁴.
- 4) Fourth, as we have seen, not all the robot technology possesses cognitive interaction capabilities. In other words, non-social robots might not replace the “social factor” that is required in the caregiver-receiver relationship.

⁹²⁰ This report was consulted with the following committees: transport and tourism; civil liberties, justice and home affairs; employment and social affairs; environment, public health and food safety; industry, research and energy; and the internal market and consumer protection. See www.europarl.europa.eu/sides/getDoc.do?pubRef=-//EP//TEXT+REPORT+A8-2017-0005+0+DOC+XML+V0//EN

⁹²¹ Moral Machines? Ethical Implications of Contemporary Robotics Workshop at ETH Zürich, 23rd and 24th of February 2017. Link: <https://roboethics.ch/>

⁹²² Visit the website at <http://www.humanitasdeventer.nl>

⁹²³ That is what is happening with the shared economy. With companies like Uber or Airbnb we are allowing people that lack formation to conduct the activity they are doing, as if everyone was capable of becoming a taxi driver or a host. While the benefits of shared economy are enormous and may be a good solution to decrease economical crisis, it can impact on the quality of the services we are offering.

⁹²⁴ See the Data Analysis and Collection through Robotic Companions and LEGO Engineering with Children on the Autism Spectrum project at roboautism.k12engineering.com/?page_id=2

- 5) Fifth, that robots can perform actions that humans might not ever be able to process, especially if they use machine learning techniques and artificial intelligent systems, like Watson oncology⁹²⁵.
- 6) And sixth, there are many occasions where humans might want to avoid the human contact. For instance, it is found that users are embarrassed when, being an already-grown up, need to be fed. The HERL wheelchair with a robotic arm with a feeding function can be the solution to that problem.

Unfortunately, this care-robot section is only a partial reflection of what care robots are and how healthcare robotic technology works. Although it is a resolution from the European Parliament and has no binding force – and now the European Commission has to decide on the topic – one cannot disregard all the benefits and, foremost, all the negative implications of a particular robotic technology, at risk to create legislation that both hampers innovation – which would be a minor problem – and does not provide the appropriate safeguards for the users. In a moment where there are some States that develop legislation concerning robots – robot deliveries in this case⁹²⁶ – as well as the European Union⁹²⁷, legislators should make informed decisions to ensure safer products and allow innovation and scientific progress without being influenced by industrial pressure or by science fiction.

As shown in the following picture, a (future) robot policy might look like a very complex ensemble – especially if we believe that there is no need for a new legislation. Beyond the different stakeholders' interests, several characteristics that link to (existing) regulatory aspects such as recording devices or data sensors, or the HRI the legislation might look very differently. Indeed, an exoskeleton fastened to your body is not the same as a companion robot that has a conversation with the user.

⁹²⁵ Watson for Oncology tries to find evidence-based patient-centric treatment options. *See* www.ibm.com/watson/health/oncology-and-genomics/oncology/

⁹²⁶ Regan, T. (2017) Virginia is the First to Legalize Delivery Robots. You better start getting used to a more crowded sidewalk. *See* www.engadget.com/2017/03/02/virginia-is-the-first-state-to-legalize-delivery-robots/

⁹²⁷ On the 2nd Feb 2017 the European Economic Social Committee held an open hearing on artificial intelligence and society that aims at feeding a proposal for a EU policy on Artificial Intelligence. *See* <http://www.eesc.europa.eu/?i=portal.en.events-and-activities-artificial-intelligence>

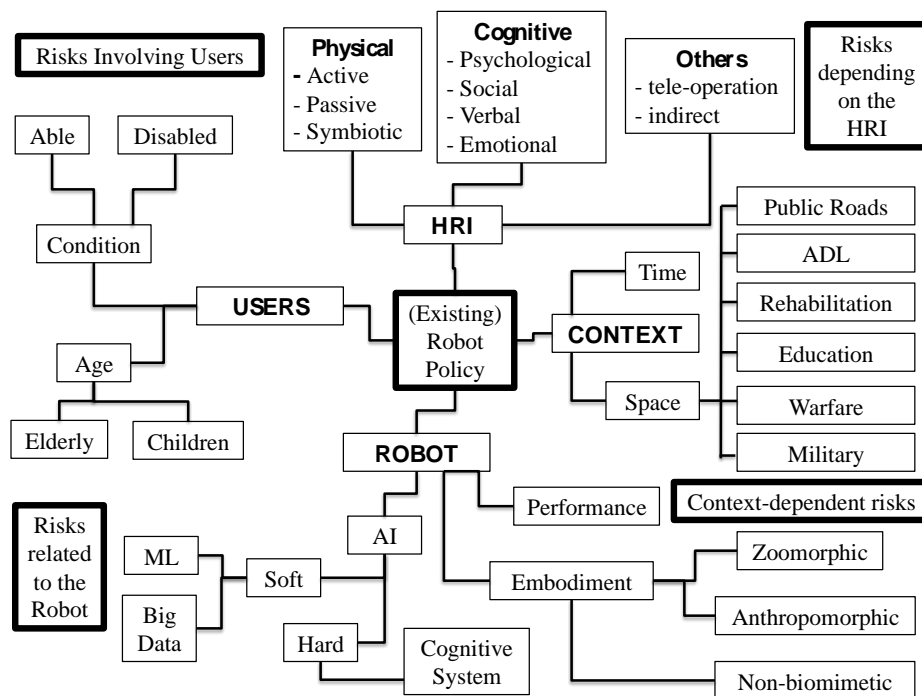

Figure 58 Example of Aspects to Be Taken into Account in a Robotic Policy⁹²⁸

It could happen that, as we mentioned at the beginning, the future reform of the Medical Device directive could embrace these types of robotic technology. However, either the meaning of the regulation or the compliance procedure may not be that clear for all the healthcare robots – especially if they do not fall under the scope of the proposed regulation. Moreover, innovation always challenges the boundaries of the application of the regulatory framework bringing most of the times the winds of change on the interpretation and the development of the law⁹²⁹. Some sort of guideline, instruction or direction – as it has happened with drone technology⁹³⁰ – from a competent authority concerning healthcare is, in our opinion, of major to give clarity to the topic and promote safer technology.

After all the analysis, we identified some recurrent topics, issues and gaps that we believe need to be addressed by regulatory bodies – at least to be incorporated into their discussions. These regulatory bodies could be at any level – public and private – and it could be at an upscaling mode, starting from the municipality that is asked permission to conduct certain experiments – by researchers developing a robot⁹³¹ – or directly a higher transnational body like the European Union that since 2017 – after

⁹²⁸ At this respect, see SPARC EU Robotics Multi Annual Roadmap from 2016: sparc-robotics.eu/wp-content/uploads/2014/05/H2020-Robotics-Multi-Annual-Roadmap-ICT-2016.pdf

⁹²⁹ Fosch Villaronga, E. and Heldeweg, M. (2017) op. cit.

⁹³⁰ Article 29 Working Party (2015) Opinion 01/2015 on Privacy and Data Protection Issues relating to the Utilisation of Drones. See ec.europa.eu/justice/data-protection/article-29/documentation/opinion-recommendation/files/2015/wp231_en.pdf

⁹³¹ As the researchers in Picciolo when developing the Dustbot. See Ferri, G., et al. (2011, May). DustCart, an autonomous robot for door-to-door garbage collection: From DustBot project to the experimentation in the small town of Peccioli. In *Robotics and Automation (ICRA), 2011 IEEE International Conference on* (pp. 655-660). IEEE.

the resolution of the European Parliament – is considering the possibility to develop civil rules for robots.

This chapter compiles all the information that we have been using and quoting in the previous chapters in a policy guideline format. The main goal of the chapter is to be informative to policy and lawmakers so that their discussions on regulating healthcare robot are framed. The selection criterion for the following policy briefing is not random, but it comes as a direct consequence of the previous chapters. Every chapter (3 A/B and 4) of this work has been analyzed and information concerning policy changes or important aspects for policy discussions has been included and framed into the same sections as for the chapters. This has been done to be consistent with the idea that the relationship between technology – of any type but in this case robotic – and regulation, should not be unidirectional in any sense. Both (robotic) technology and regulation should be in a continuous dialogue that, on the one side, it can arise awareness on the importance of the respect for the law; and, on the other side, it can allow evidence-based policies to adequately frame the appropriate safeguards that ensure both market entrance and protection of users' rights.

Here we will address fundamental concepts following the 2012 European Parliament Research Service document called “Legal and Ethical Reflections Concerning Robotics”, a policy briefing that identifies the areas of interest and concern, possible issues and challenges of cyber-physical systems in selected policy areas, including transport, trade, civil liberties, safety, health, energy and environment, and horizontal issues. Every area of interest or concern, issue or challenge or recommendation concerning a precise technology will be accompanied by a short justification, by a reference to the source of information where it comes from, which can be a piece of relevant literature or a conclusion/result/finding of the work we arrived to after completing the previous chapters. We will divide the issues concerning generally speaking personal care robots and then more specifically the sub-types of personal care robots.

2. General issues and challenges for personal care robots

General issues and challenges concerning safety for personal care robots

We have said a lot about safety during the particular analysis of each of the robots. Here there are some general recommendations we extracted as conclusions after completion of the previous chapters. To not make the chapter longer, we will redirect with quotes to where the reader can find the information where this comes from.

- Assessment procedures to make sure the functionality and safety of autonomous and semi-autonomous personal care robots⁹³².
- Give value to the division of certified and perceived safety⁹³³.
- Need to introduce risk assessment procedures for non-technical challenges⁹³⁴.

⁹³² See Chapter 3-4 autonomy sections, especially when referring to the autonomous behavior of the robot

⁹³³ See chapter 4, safety section. Salem et al. op. cit.

⁹³⁴ See the importance of the multi-faceted risk methodology in Chapter 2.

- Potential need to incorporate cognitive aspects concerning the user into the safety requirements⁹³⁵.
- Consider the application of multiple requirement safeguard system for robots that interact sporadically with users and for those that interact with users in a more continuous manner – relationship⁹³⁶.
- Safety requirements for multiple category robots, e.g. a wheelchair with an industrial arm for feeding purposes⁹³⁷.
- Considering the testing zones as empirical data and information hubs for regulatory purposes: to identify core issues and establish the likelihood of occurrence of a particular risk⁹³⁸.
- Safety aspects of personal care robots operating in public, private or in both public-private spaces⁹³⁹.
- Protocol of actuation before the use of personal care robots in certain environments – elderly care⁹⁴⁰.
- Ensuring safety in multiple robot transformations, in both during state A and B, but also in the transition time between states⁹⁴¹.
- The overall procedure of robot adoption may have to be considered, from the design, to the creation and the implementation⁹⁴².
- The need to create cognitive human-robot interaction guidelines and safety standards⁹⁴³.
- Collection of methodologies, guidelines and protocols of actuation for the inclusion of safeguards and protective measures for non-mission tasks in diverse environments – public/private spaces⁹⁴⁴.
- Considering incorporating legibility for personal care robots to foresee robots' intentions and anticipate robot's behavior to avoid potential risks⁹⁴⁵.
- The use of reinforcement learning outside the testing zone and with vulnerable parts of the society will have to be reconsidered⁹⁴⁶.

⁹³⁵ See chapter 3 B, safety section. Olivier, J. op. cit.

⁹³⁶ See chapter 4, safety and ethics section.

⁹³⁷ Chapter 3 A section dignity and justice.

⁹³⁸ Chapter 2 in the identification of risks step, but more in detail in chapter 3 A.

⁹³⁹ Chapter 3 A, for outdoor person carriers, in safety section.

⁹⁴⁰ As we quoted before, the EU Parliament states "Researchers should seek to maximize the benefits of their work at all stages, from inception through to dissemination. Harm to research participants/human subject/an experiment, trial, or study participant or subject must be avoided. Where risks arise as an unavoidable and integral element of the research, robust risk assessment and management protocols should be developed and complied with. Normally, the risk of harm should be no greater than that encountered in ordinary life, i.e. people should not be exposed to risks greater than or additional to those to which they are exposed in their normal lifestyles. The operation of a robotics system should always be based on a thorough risk assessment process, which should be informed by the precautionary and proportionality principles". Resolution 2017 on Civil rules for robots. See also Last part of the section 5 of chapter 4, in relation to the autistic research conducted in Nantes.

⁹⁴¹ Chapter 3 A, section safety.

⁹⁴² Chapter 2, in the risk methodology applied for legal matters section. All risk-based approaches have a cyclic nature that allows the interception of risks and their mitigation at any stage of the procedure.

⁹⁴³ Chapter 4, in relation to the cognitive HRI in mobile servant robots that completely differs from the active physical HRI from physical assistants or the passive/dependant-on-the-interface physical HRI in person carriers.

⁹⁴⁴ This was highlighted in chapter 3 A, but it applies to 3 B and 4 chapters too.

⁹⁴⁵ Mentioned in chapter 3 A, applicable in social robots too.

⁹⁴⁶ This refers to the patent of Google mentioned in Chapter 4. The following statement of the patent "the robot may respond to the negative reinforcement response by continuing to perform other tasks until a positive reinforcement response is received" should be carefully revised because it can extremely endanger the user.

- Consider including the education of the robot and machine learning algorithms as an essential part of the safety cycle process of the robot⁹⁴⁷.
- In safety matters, it is important to reduce the risk, and to reduce the uncertainty. Different strategies can be used to reduce uncertainty: inherent safe design (eliminate the hazard from the system), safety reserves (safety factors/margins), safe fail (the system remains safe when it fails) and procedural safeguards (reinforcing audits)⁹⁴⁸.

<p>General issues and challenges concerning consumer robotics for personal care robots</p>
--

- Certifications, safety requirements and testing zones for multiple category robots, with different embodiments⁹⁴⁹.
- Special attention should be drawn to unfair and deceptive robots⁹⁵⁰.
- Stating the need to promote green and eco-friendly robotics, i.e. improving energy efficiency, reducing waste⁹⁵¹.
- The need to create guidelines on the eco-design of robot technology⁹⁵².
- User-centered design including ethical guidelines on the design of robots that interact in care environments⁹⁵³.
- Recognize the individuality and specificity of each robot, as products have: as most products are unique, each product may need to comply with different requirements⁹⁵⁴.
- Consider launching a user-friendly portal to help roboticists know what are the legal requirements that need to take into account for their creations through some basic questions⁹⁵⁵.
- Consider the creation of a European Robot Agency to manage all the certifications of robots⁹⁵⁶.
- The European Robot Agency could define standards for best practices and recommend regulatory measures, define new principles and address potential consumer protection issues⁹⁵⁷.

⁹⁴⁷ This relates to the work of Amodei et al. op. cit. and refers to the perfection over time that machine learning algorithms provide to certain applications. These will have to be reconsidered in the case of robot technology: until when a machine learning algorithm is ready to go out to the market?

⁹⁴⁸ Varshney, K. R. (2016). Engineering Safety in Machine Learning. *arXiv preprint arXiv:1601.04126*.

⁹⁴⁹ This is highlighted over the course of this whole work, since Chapter 1, to Chapter 3A. It also reflects the need to have testing zones for policymaking purposes as the work of Weng et al. op. cit. highlight.

⁹⁵⁰ Chapter 3A, this refers to the work of Hartzog, W. op. cit. This could include initiatives as to avoid the use of videos of the robot that do not match with the actual capacities of the robot and prohibit convincing people that robots can do certain activities that are not true.

⁹⁵¹ This relates to chapter 3B but it could be applied to all robots, as all of them work with external sources of energy and are not powered in any sustainable form. This could include to consider the robots as help for users to be more ecological.

⁹⁵² This recommendation has not been highlighted before, but on the course of this work we realized that there is very little literature on eco-friendly robots and guidelines on how to achieve that.

⁹⁵³ This refers to the work of Wynsberghe, A. van (2013) op. cit. See also Vallor, S. (2011). Carebots and caregivers: Sustaining the ethical ideal of care in the twenty-first century. *Philosophy & Technology*, 24(3), 251-268.

⁹⁵⁴ Already mentioned above. See Chapters 3-4. See future steps in the conclusion chapter referring to the newest application of the consumer safety product commission of the U.S.

⁹⁵⁵ *Ibidem*.

⁹⁵⁶ See Resolution 2017 of the EU Parliament concerning civil rules for robots.

⁹⁵⁷ *Ibidem*. See also Calo, R. (2014) The case for a Federal Robotics Commission at www.brookings.edu/research/the-case-for-a-federal-robotics-commission/

- Consider different certifications for the brain of the robot (e.g. externalized to a cloud provider) and for the physical embodiment of the robot⁹⁵⁸.
- The creation of an international instrument to provide clarity on personal care robots would be desired in order to avoid differences between different countries and provide the same level of standards⁹⁵⁹.

<p>General issues and challenges concerning liability for personal care robots</p>
--

- Stating the fact that prevention is important, implementing instruments and procedures to avoid harm occurrence shall be considered⁹⁶⁰.
- The latest advancements in harm prevention include the creation of living labs that can recreate real-life scenarios and can allow producers test their robots in a safe zone⁹⁶¹.
- Stating the need to connect the living lab / testing zone with the regulatory framework through the empirical data collection and analysis⁹⁶².
- Highlighting the fact that living labs will differ depending on the characteristics of the robot and its intended context of use. For instance, a drone might require an airport as a living lab, but a care robot might need a care setting⁹⁶³.
- Considering to incorporate self-explanatory systems into the robots to determine the error⁹⁶⁴.
- Considering the use of simulation as a cost-effective solution prior the investment of money and time on the construction of a living lab⁹⁶⁵.
- A robot-seal could be considered as a proof for robot legal compliance⁹⁶⁶.
- Consider the possibility that robots have to be tested in real-life scenarios under several circumstances and safeguards, i.e. under deregulation schemas and not directly applicable in all domains – healthcare might need specific attention⁹⁶⁷.

⁹⁵⁸ This refers to chapter 4 but also to 3 A, both in the section of user's rights. As we do have some research on data protection impact assessment for cloud services (*see* Alnemr, R., Cayirci, E., Dalla Corte, L., Garaga, A., Leenes, R., Mhundu, R., et al. (2015, October). A data protection impact assessment methodology for cloud. In *Annual Privacy Forum* (pp. 60-92). Springer International Publishing) we do not have such research for robotic technology using cloud services.

⁹⁵⁹ This comment was raised in one of the workshops we carried out in 2016 as part of the workshop series on legal and ethical aspects of robots in therapy and education (*see* legalaspectsofsocialrobots.wordpress.com). Everyone agreed on the importance of having an international document that could cover all these aspects. The format of the document could be similar to the Convention 108 on data protection matters of the Council of Europe, which is open to third countries.

⁹⁶⁰ This goes in line with the CRIA explained in chapter 2.

⁹⁶¹ *See* Eskelinen, J. et al. (2015) op. cit.

⁹⁶² Although the empirical data does not connect to the author, the use of testing zones for policymaking purposes yes. *See* Went et al. 2015 op. cit.

⁹⁶³ This seems like an obvious remark and might not be strictly quoted before, but goes in line with the fact that different robots may need to comply with different requirements. Although surgery robots should follow a protocol and only could be used after certain simulator hours, and as it is obvious, these protocols/simulators will completely differ from aviation ones.

⁹⁶⁴ This is in relation to the responsibility gap highlighted by Johnson, D. (2015) op. cit. but it could relate to the upcoming right to explanation enshrined in the General Data Protection Regulation.

⁹⁶⁵ This conclusion is because of the work in Nishida lab that we went to visit in a trip to Japan during November 2016. They are using simulators and a 360 degree dome for HRI studies. *See* chapter 4, section liability.

⁹⁶⁶ Inspired by the European Privacy Seal, and mentioned in chapter 2, but also on the ecological label, a Robot Seal could be ideated as a legal compliance proof for robot technology, in this case for care applications.

⁹⁶⁷ This comment is complementary to the need of having testing zones, as it might happen that there are risks that cannot be found in the testing zone because they need to be in real environments. This may happen

- For certain developments and uses, consider applying the precautionary principle to anticipate potential safety impacts and encourage progress for the benefit of society and the environment⁹⁶⁸.
- Robots can provoke problems in the future after their usage. Prospective liability scenarios will have to be secured⁹⁶⁹.
- A clearer legislation on the responsibilities in case of failed or harmful robotic systems could help the allocation of responsibility. International commerce terms – Incoterms – could be considered as a starting point at this regard⁹⁷⁰.
- The inclusion of a protocol prior robot usage similar to the protocols used in (manned) aircrafts shall be taken into account to avoid further harms⁹⁷¹.
- Black boxes might have to be considered as a *conditio sine qua non* of the robotic system, although autonomous systems might challenge the configuration of the boxes⁹⁷².
- In the light of the responsibility-gap discussions, there might be the need to identify and determine how to proceed if a robot behavior cannot be traced back to a human error⁹⁷³.
- Although there might be some similarities with the legal status of animals, corporations, the roman institution of *peculium* or electronic agents, robots might also be different from all of them, and clarity on whether they deserve – and in what terms – an extension of the legal system might be necessary⁹⁷⁴.
- Shared autonomy could be considered to help allocate responsibility⁹⁷⁵.
- Accountability plays a major role for complex technologies and shall be considered as a fundamental part of future robotic policies. This could model responsible development and use of robotics⁹⁷⁶.
- As there can be the possibility that a robot causes harms in the future, insurance could help repair the damages, which should be determined according to the different types of robot (characteristics and capabilities)⁹⁷⁷.

when applying simulation, testing zone and real environment, and different safeguards should be applied in any case.

⁹⁶⁸ This was first mentioned in chapter 2 when ISO 13482:2014 has notice of the specificities of different user groups but it did not release any of the safeguards in 2014.

⁹⁶⁹ This is particularly interesting in physical assistant robots, but also with mobile servant robots the use of which might not be certain that is not harmful over time, on a cognitive level for instance. This refers to Datteri, E. (2013) op. cit.

⁹⁷⁰ Chapter 3 A liability section.

⁹⁷¹ See the above note on protocols.

⁹⁷² Chapter 3 A liability section.

⁹⁷³ This is in relation to latest resolution of the EU Parliament 2017 op. cit. when it quotes its concerns at this regard and introduces also the responsibility of the teacher [although we argued that it might not be the solution in self-learning systems, see Fosch-Villaronga (2016) What do roboticists need to know about the law op. cit.], and to Johnson 2016 op. cit. that talks about the responsibility gap, quoted in chapter 2, state-of-the-art section. It refers also to the electronic agent's legislation from US in 1999.

⁹⁷⁴ Several authors have been quoted along the thesis at this regard, mainly Pagallo 2013 op. cit., Laukyte, M. 2013 op. cit. or Teubner, G. 2016 op. cit. We argued in chapter 2 that it might be possible that the policymakers focus on the creation of the “robothood” as a new type of agent without connecting it with corporations or animals because robots are not either of them.

⁹⁷⁵ See chapter 3A. This refers to the study of Souza L et al. (2007) op. cit. when the users of wheelchair had the shared autonomy mode so the wheelchair compensated the wrong movements of the user due to their disorder. This could be modeled in a way that it clearly states which part is being carried out by the machine and which by the user so that responsibility could be shared.

⁹⁷⁶ This is a general principle that can be found in chapter 2, when we decided to use the impact assessment methodology to carry out the content of this thesis, as it is part of the accountability process.

⁹⁷⁷ This not only relates to the “transfer” of risk as we referred so in chapter 2, but also to the possibility that the EU Parliament mentioned on its latest resolution – an obligatory insurance schema (even if it is not specified which robots), and supplemented by a fund in order to ensure that damages can be compensated for in cases where no insurance cover exists. To now, the resolution only talks about “autonomous robots”

- If a responsibility of the teacher is ever implemented, division of responsibilities should be carefully addressed. In the light of the responsibility gap, it will be crucial to know what happens when the teacher of the robot is another robot⁹⁷⁸.
- The roboticists will have to predict future bad consequences of their creations in order to avoid a butterfly effect⁹⁷⁹.
- Reversibility could help model liability, but it should be carefully translated in the case of personal care robots, as there might be actions - such as the physical harm of the user - that might not be reversible⁹⁸⁰.
- Relevant literature suggests that the designers are the ones that will have probably specified wrongly the objective function (which if maximized, can lead to a harmful situation)⁹⁸¹.
- When implementing safeguards, ignorance of other aspects of the environment that might be 1) important and 2) susceptible to change, can lead to wrong objective functions (negative side effects)⁹⁸².
- Reward hacking (for reinforcement learning) could also pervert the intentions of the designer⁹⁸³.
- Considering the discussion of the design and evaluation protocols with potential users and stakeholders when evaluating the benefits and risks of robotics, including cognitive, psychological and environmental ones⁹⁸⁴.

<p>General issues and challenges concerning user rights for personal care robots</p>
--

- Importance to prevent roboticists from creating technology that unlawfully invades human's privacy, from collecting unnecessary data and creating profiles without consent, to violating intellectual property rights, surveilling citizens, selling personal data to third parties and, above all, creating discrimination scenarios⁹⁸⁵.

but it is not clear whether an unmanned underground vehicle would need the same insurance as an exoskeleton.

⁹⁷⁸ We mentioned this in chapter 4 in the liability section when we mentioned the possibility that the increasing use of cloud computing capabilities in robot technology (the so-called *cloud robotics*) might challenge the application of the responsibility of the teacher, as it might be extremely difficult to track back who has taught what to whom, and who was responsible to uploaded into the cloud so that other robots could learn from it.

⁹⁷⁹ This goes in line with the possibility that the future European law on robots (after the EU Parliament 2017 resolution op. cit.) establishes that roboticists may remain accountable for the social, environmental and human health impacts that robotics may impose on present and future generations.

⁹⁸⁰ This was mentioned in chapter 3 B, when we were talking about exoskeletons. If the exoskeleton has provoked a fatal force to the user and hurt her/him, or if the user has fallen due to any movement of the robotic device, it would be impossible to "reverse" the action. Thus, the principle of reversibility might not work when a physical or cognitive HRI exists, even if in the latter case we are not very sure about what consequences could that have in the human.

⁹⁸¹ Amodei, D., et al. (2016). Op. cit.

⁹⁸² ibidem.

⁹⁸³ Bostrom, N. op cit.

⁹⁸⁴ EU Parliament Resolution (2017) op. cit.

⁹⁸⁵ This is a general data-protection friendly statement. The uncertainty about "informed" consent and also the third uses of collected personal data has been mentioned along the 3-4 chapters.

- The need to spread the meaning of informational privacy: restricting the access to information of any aspect of human life⁹⁸⁶.
- Promote transparent-friendly systems on data usage⁹⁸⁷.
- Data minimization principle and principle of proportionality of the data processing should be explained in the case of robot technology that use big data, artificial intelligence systems, and tons of personal data⁹⁸⁸.
- It can happen that the designer might have designed safely the objective functions but the universe of data is insufficient. A balance between data collection and safety of the operation should be ensured⁹⁸⁹.
- Informed consent may already have its own limitations – language, religion or false expectations – but action delegation to the robot may incredibly challenge informed consent⁹⁹⁰.
- Finding connections in big data environments may not justify the collection of the data on the first place⁹⁹¹.
- General population might need education on the importance of the data protection fundamental right because, first, individuals are constantly making privacy-related decisions that affect people’s well-being; and, second, actual customers’ perceptions of the benefits are more influential than their concerns about the risks⁹⁹².
- The use of personal care robot technology that continuously track and monitor them could cause consumers anxiety⁹⁹³.
- There is the extreme need to determine what does privacy-by-design mean, which may include both technical and organizational measures, and might be important for care robots⁹⁹⁴.
- The use of a programming language that could ease the implementation of privacy policies should be considered as a fundamental part of the privacy-by-design principle⁹⁹⁵.
- The need to establish clear rules on data controller and data processor roles in the case of personal care robots⁹⁹⁶.
- Machine learning techniques might challenge the right to be forgotten⁹⁹⁷.

⁹⁸⁶ This is in relation to the article of Koops 2016 op. cit. on the different types of privacy that exist, quoted in the state of the art chapter.

⁹⁸⁷ This has been quoted at the user’s rights section of chapter 3A, but also mentioned along other sections, especially when quoting the EU Parliament resolution op. cit.

⁹⁸⁸ See chapter 4 user rights section.

⁹⁸⁹ Amodei, D., et al. (2016). Op. cit.

⁹⁹⁰ See also Nijhawan, L.P. et al. (2013) op. cit.

⁹⁹¹ IC UK (2014) Big Data and Data Protection op. cit.

⁹⁹² This has been explained in the section of user safeguards in chapters 3-4. This a general statement that concerns also to physical/cognitive safety: an intrusion to the data protection right might not cause any harm and, thus, not be noticeable by the user. See also Acquisti, A., John, L. K., & Loewenstein, G. (2013) op. cit.

⁹⁹³ This is a challenge that has not been largely studied, as mentioned in chapter 4 section user’s rights’ section. See Becker, M. et al (2013) op. cit.

⁹⁹⁴ This is a general statement that has mentioned over the chapters, and that it gets clearer in the Koops and Leenes op. cit. article when they mention how difficult it is to hardcode privacy into the design of the system, and that it may never happen – a complete hardcoding of privacy – because *organizational measures* are not to be hardcoded.

⁹⁹⁵ This is mentioned in the lack of a clear understanding of what does privacy by design mean, and it refers to the software developed by Jean Jan at MIT, see projects.csail.mit.edu/jeeves/

⁹⁹⁶ More research is needed to understand these differences, as mentioned in the sections of user rights in chapters 3-4.

⁹⁹⁷ This is a general concern we had with different colleagues, see Kieseberg, P., Li, T. and Fosch Villaronga, E. (2017) Humans Forget, Machines Remember: Artificial Intelligence and the Right to Be Forgotten. 7th Annual Internet Law Works-in-Progress Conference, Santa Clara University School of Law, 4 March 2017,

- Cloud robotics may offer benefits by allowing component reuse across different systems and developers, human knowledge about the component usage, robustness, and efficiency. Challenges concerning this technology – veracity of the information, consent of the user – will have to be addressed too⁹⁹⁸.
- All the collected information from the robots might be processed in data mining (spatial, behavioral, associational, etc.) and could turn into new surveillance options⁹⁹⁹.
- Although finding hidden connections thanks to big data techniques could be possibly useful for future developments; finding the correlation does not retrospectively justify obtaining the data in the first place¹⁰⁰⁰.
- Some steps towards the creation of standards for anonymizing data shall be taken from major institutions, although the anonymisation of data does not involve per se the loss of the “personal” feature in personal data¹⁰⁰¹.
- Because large amount of – even if anonymized – data processed automatically might entail a risk of re-identification, special promotion of the data minimization principle should take place¹⁰⁰².
- It is important to state the fact that when computers have a virus, they do not work properly; and the same could happen with robots¹⁰⁰³.
- Obvious opt-out mechanisms (kill switches) that should be consistent with reasonable design objectives should be implemented. These should be re-phrased in the context of data privacy, to avoid “always-on” devices that process and collect data continuously¹⁰⁰⁴.
- There should be a thorough discussion on how to handle privacy post mortem¹⁰⁰⁵.
- The prohibition of automated individual decisions that significantly affect individuals that refers to profiling avoidance shall be concretized for personal care robots¹⁰⁰⁶.
- Classical mechanisms to obtain consent might not apply in personal care robots, as it could be practically impossible to ask for consent each time robots perform

mentioned in chapter 3 A and retaken in chapter 4, and that goes in line with the Koops and Leenes op. cit. idea that the General Data Protection Regulation might not be directly applicable as it may seem from its corpus.

⁹⁹⁸ This is not a challenge or a concern, it is more of an opportunity that comes from the use of cloud robotics. See in particular chapter 4 user rights’ section.

⁹⁹⁹ See Chapter 3 user rights’ section, and also Holler, J. et al. (2014).

¹⁰⁰⁰ This relates to the work of the Information Commissioner’s Office UK (2014) mentioned in chapter 4 user rights’ section.

¹⁰⁰¹ Mentioned in chapter 3 B, and referring to wearable devices, see the work of Hamblen M. (2015) op. cit.

¹⁰⁰² Although this has been mentioned in chapter 3A, it could apply to all person carriers.

¹⁰⁰³ This comment was inserted after we talked with Sophie Sakka, a researcher at CNR in France after MESROB 2016 Conference. After learning a bit more on the topic, we came across with some literature that is dealing with this particular problem, in the COGNIRON project from FP6. See Syrdal, D. S., et al. (2007) op. cit. This has been mentioned in Chapter 4.

¹⁰⁰⁴ This is one of the main findings. After having received a lot of media coverage (see for instance Wakefield, J. (2017) MEPs vote on robots’ legal status - and if a kill switch is required, BBC, available at www.bbc.com/news/technology-38583360) EU Parliament mentioned that designers should integrate obvious opt-out mechanisms (kill switches) that should be consistent with reasonable design objectives. But nothing is said on what does it mean: whether it refers to stop moving the robot, to stop processing the data, etc.

¹⁰⁰⁵ This was mentioned in chapter 4. See Edwards, L., and Harbinja, E. (2013). Op. cit.

¹⁰⁰⁶ This goes in line with the upcoming General Data Protection Regulation and because most of these devices are born to be personalized.

a new action (learned by the internet or another robot for instance). A dynamic consent model shall be considered¹⁰⁰⁷.

- Modern techniques allow secondary, not pre-specified uses of the collected data very easily, and processing such data with a new aim or for a new use. If there is no consent for this secondary use, this practice should be banned¹⁰⁰⁸.
- The translation of the responsibility to the data subject on privacy matters implies position power from the companies because 1) users do not read the terms and conditions; 2) users receive vague data privacy disclaims – normally to improve the services they offer; 3) users are not aware of the monetize value of this data¹⁰⁰⁹.

General issues and challenges concerning autonomy for personal care robots

- Autonomy straddles between user's autonomy and the delegation of decision-making¹⁰¹⁰.
- It is important to differentiate robot's autonomy – robot behavior – and user's autonomy¹⁰¹¹.
- Within user's autonomy, it is important to differentiate between autonomy – which would relate more to social robot, in this case mobile servant robots – and independence – which would relate more to non-social robots, in this case person carrier, and physical assistant robots¹⁰¹².
- Person carriers and physical assistants support user's independence because this technology helps users carry out tasks by themselves; mobile servant robots on the contrary do not help users perform a task, but the robots perform the task for the user, thus, challenging the user's autonomy¹⁰¹³.
- The need to create an explanatory chart of Characteristics of Operational Modes of Personal Care Robots for legal purposes. This may include: who initiates the action, the frequency of human intervention, the degree of human supervision, and if there are any user restrictions for autonomous, semi-autonomous, manual and maintenance modes in (personal care) robot technology¹⁰¹⁴.

¹⁰⁰⁷ This goes in line with what we mentioned in Chapter 4, that it could be a good idea to explore this dynamic consent for personal care robots, but that there is no literature at this regard.

¹⁰⁰⁸ Mainly *see* the Article 29 Working Party (2014) Opinion 8/2014 on the on Recent Developments on the Internet of Things quoted in chapter 4.

¹⁰⁰⁹ *See* chapter 4 section users' rights.

¹⁰¹⁰ This comes from the Robolaw Project Deliverable 6.2. *op. cit.* and it is important to ensure that the balance – this balance and any others that the law contains – can get to a more concrete explanation. In this case, if a balance needs to be enhanced between the autonomy of the user and his/her decision-making process, it could be clarified whether the system will have to put a recommendation and the user will have to accept (every time, under what conditions etc.) and how this would be modeled in each case: maybe in robotic person carriers the correction of any deficiency of the person can be done automatically, but maybe not in other assistive systems. *See* Souza et al. *op. cit.* for the carrier.

¹⁰¹¹ This is a general conclusion that can be found along the chapters. The robot's autonomy relates to liability section, agenthood and how this would undermine the autonomy of the user, in other words, the capacity that the user has to decide over what type of care – in this case – wants to receive.

¹⁰¹² *See* the Robolaw project *op. cit.* Our contribution to this sentence is identifying which type of robot falls under which category, that has not been done by the Robolaw project because they address "Care Robots" under one unique category.

¹⁰¹³ *Ibidem.*

¹⁰¹⁴ This idea comes directly from ISO 13482:2014 where it is clearly explained the different moments of action starting point. *See* Table 10 Characteristics of Operational Modes of Personal Care Robots, p. 50 ISO 13482:2014. This could be very useful for liability purposes.

- A robot action could be initiated by the robot, with no human intervention nor supervision (or with robot supervision) and this might challenge human autonomy and decision-making process¹⁰¹⁵.
- Identification of keys for trust and acceptance of personal care robots¹⁰¹⁶.
- Robot acceptance in care domain, even if decreased a bit over time, is dramatic: more than half of the interviewed population would ban the use of robots that care for children, elderly or disabled¹⁰¹⁷.
- The need to determine until what extend robots can support human decision-making processes, and the other way round¹⁰¹⁸.
- It will be important to secure robot's decision-making process in the light of imminent risk situations – in an accident for instance where the robot cannot ask permission to the user¹⁰¹⁹.
- The right not to be subject to a decision based solely on automated processing might play an important role in robot technology and will have to be redefined¹⁰²⁰.
- Declining mobility and worsening memory should not justify per se user decision-making substitution¹⁰²¹.
- Possibility to consider an autonomy-by-design principle that should be further modeled in the case of personal care robot technology¹⁰²².
- Although dependence could lead to a better acceptance ratio, dependence on robotic technology could lead users to unintended or uncertain consequences¹⁰²³.
- Moving support to an autonomous robot might decrease opportunities for rehabilitation, and if seniors become dependent on such a robot and stop moving by themselves, their own physical activity will decrease¹⁰²⁴.

<p>General issues and challenges concerning dignity for personal care robots</p>
--

- Although at the beginning of the 21st century there was not such a debate on whether robots could substitute humans, the exponential growth of robotic

¹⁰¹⁵ See chapter 4 when we quoted the patent of google op. cit., and referred to the anaphylaxis scenario. This might relate also to the responsibility gap quoted by Johnson op. cit. in chapter 2.

¹⁰¹⁶ A lot of research has been conducted on trust and care robots, to see some examples Van Wynsberghe, A. (2013) op. cit. Sharkey, A., & Sharkey, N. (2012) op. cit. but it is time that policymakers pronounce themselves on what are the key aspects that need to be respected in order to gain trust and acceptance from users.

¹⁰¹⁷ This information is part of the introduction; see Eurobarometer 2012 & 2015 op. cit.

¹⁰¹⁸ This relates to the recent applications of Watson technology, i.e. in oncology research. Our prediction in Fosch-Villaronga, E. and Kalipalya-Mruthyunjaya, V. (2016) Robot Enhancement of Cognitive and Ethical Capabilities of Humans. Robo-Philosophy, Denmark, 17-21 Oct 2016. In: Seibt, J. et al. (Eds.) (2016) What Robots Can and Should Do. Series Frontiers in Artificial Intelligence and Applications, vol. 20, pp. 223-233, IOS Press. Is that there will be a moment where users are no longer capable of checking whether the robot has taken the appropriate decision or not.

¹⁰¹⁹ See chapter 4.

¹⁰²⁰ See article 22 General Data Protection Regulation

¹⁰²¹ This is a comment made in Fosch-Villaronga, E. and Roig, A. (2017) op. cit. and relates to chapter 3A.

¹⁰²² This refers to the work of Millar, J. (2015) op. cit. and it could be modeled according to the work of Van Wynsberghe, A. 2012, although we have not explored that possibility in this work.

¹⁰²³ This refers to the work of Dario, P. et al. (2014) in the project of Ambient Assisted Living called AALLIANCE2, and mentioned in chapter 4.

¹⁰²⁴ This was mentioned in chapter 3A when referring to a Japanese study that reflected the worries of the workers. See Shiomi M et al (2015) op. cit.

technology has arisen the inquietude on the future of work and the future of employment¹⁰²⁵.

- The use of big data techniques could substitute in the future non-routine cognitive tasks, which would affect both skilled and unskilled workers¹⁰²⁶.
- Poverty might not justify the existence of undignified jobs. Moreover, Robotic technology might offer capabilities to current workers that could have been impossible otherwise¹⁰²⁷.
- In Europe the population that are Not in Education, Employment or Training (NEET) rates are alarming: 16.1% of the total European population from 15 to 34 years are neither studying nor working¹⁰²⁸.
- The employment of robots is a worldwide phenomenon¹⁰²⁹.
- The need to consider the principle of non-isolation and the promotion of human-human interaction and empathy to avoid the decrease of human-human interactions due to the use of personal care robots¹⁰³⁰.
- Stating the importance of avoiding the replacement of humans and of human feelings in social contexts¹⁰³¹.
- Personal care robots might be a good option for robot assistance over time, as it can adapt to user's needs and can provide information that until now has been impossible to collect¹⁰³².
- Instead of translating human emotions into robots it could be considered to implement emotional coordination: build up some mixed, human-robot, emotional ecologies, with affective co-evolution¹⁰³³.
- There could be the case that the institutions employing robot technology have to offer a human alternative in the light of the right to human intervention in the data protection regulation¹⁰³⁴.

General issues and challenges concerning ethics for personal care robots

- A robot should operate according to the local national and international ethical standards¹⁰³⁵.

¹⁰²⁵ This is a general statement that has been covered by recent media and that it starts with a quote from a Carnegie Mellon University research, *see* chapter 4.

¹⁰²⁶ This is highlighted in the work of Fosch-Villaronga, E. and Kalipalya-Mruthyunjaya, V. (2016) *op. cit.* and was inspired by the work of Frey, C. B. and Osborne, M. A. (2013) *op. cit.* quoted in chapter 4.

¹⁰²⁷ In other words Pistono, F. (2014) *op. cit.* This might be interesting to take into account as a counterargument into the ongoing discussion in whether robots are replacing the human factor and whether some jobs would be justifiable as they are not dignifying for the person. In care applications might not be the case, although for instance some new hospitals employ robots to deliver medicine, food and laundry to the rooms, which was carried out before by nurses.

¹⁰²⁸ This might be a relevant factor to take into account what is the education that future generations will have to receive once they have to be inserted into the labor market. *See* mostly Fosch-Villaronga, E. and Kalipalya-Mruthyunjaya, V. (2016) *op. cit.* and chapter 4.

¹⁰²⁹ Chapter 4, Pistono, F. (2014) *op. cit.*

¹⁰³⁰ This refers to social robots, and because of the worry of the EU Parliament Resolution *op. cit.* on the dehumanization of the caring practices if the human factor is removed. Although it might not be considered, yet, a personal care robot, the project Hookie of Prof. Dr. Albo-Canals works precisely on promoting human-human interaction among autistic children. *See* <http://dynatech2012.com/home/>.

¹⁰³¹ *Ibidem*.

¹⁰³² Personalization of care is the prim

¹⁰³³ Chapter 4.

¹⁰³⁴ *See* article 22 General Data Protection Regulation

¹⁰³⁵ This relates to the EU Parliament Resolution (2017) *op. cit.*, although it is not very clear how this could be modeled in the case of personal care robots.

- Risks concerning personal care robots can also have ethical implications¹⁰³⁶.
- It is uncertain to what extent personal care robot creators should incorporate features beyond mere technical aspects in their design process because there are currently no legally binding frameworks or guidelines on the creation of robotic technology that could approach ethical implications¹⁰³⁷.
- The need to consider whether it is feasible to embed ethics into the design process of personal care robots¹⁰³⁸.
- Stating the need for the creation of a code of ethics for engineers building robots for care purposes¹⁰³⁹.
- Religion may play an important role on the acceptance of robot technology¹⁰⁴⁰.
- A guiding ethical framework should be based on the principles of beneficence, non-maleficence and autonomy, as well as on the principles enshrined in the EU Charter of Fundamental Rights, such as human dignity and human rights, equality, justice and equity, non-discrimination and non-stigmatization, autonomy and individual responsibility, informed consent, privacy and social responsibility, and on existing ethical practices and codes¹⁰⁴¹.
- The more a robot is autonomous, like multifunctional social assistive robots, the more it will need to be sensible to values and norms¹⁰⁴².
- Caregiver organizations do not envision social assistive robots in social interaction scenarios, such as giving the gentle touch of a hand, the warmth of a hug or the understanding of a conflict or an epileptic crisis¹⁰⁴³.
- Need to consider the reduction of scenarios containing ethical dilemmas yet not solved in the human-being world, e.g. the trolley problem¹⁰⁴⁴.
- Robot empathy might increase the knowledge of human nature, as empathy is part of the human social structure¹⁰⁴⁵.
- It might be important to know that humans do not always expect robots to act according to the same moral norms applying to humans¹⁰⁴⁶.
- It is not clear whether mood recognition (and, in general, emotion recognition) should be allowed by robotic technology¹⁰⁴⁷.

¹⁰³⁶ In other words, Salem et al. (2015) op. cit. in chapter 4. *See also* Moral Machines? Ethical Implications of Contemporary Robotics Workshop at ETH Zürich, 23rd and 24th of February 2017. Link: <https://roboethics.ch/>

¹⁰³⁷ This is a general statement, although the latest standards or initiatives point to this direction, *see* BS 8611:2016, or IEEE Ethically Designed Robots.

¹⁰³⁸ This relates to the IEEE initiative op. cit. but also to the work of Koops and Leenes, op. cit.

¹⁰³⁹ This is in relation to the EU Parliament Resolution op. cit. because they come up with a general frame for designers, but we assume that it should be different for care robot, as it is another type of domain than military or transportation.

¹⁰⁴⁰ Van Wynsberghe (2013) op. cit. *See also* Zaghلامي, L. (2016) How Religious Beliefs Deal with Robotization. New Friends 2016, Conference Proceedings. Ethical, Legal and Societal Issues of Robots in Therapy and Education Workshop. And also chapter 4, ethics section.

¹⁰⁴¹ Ibidem. Also quoted in the article of B-J. Koops et al. (2013) op. cit.

¹⁰⁴² Kuestenmacher A, et al. (2014) op. cit. in chapter 4.

¹⁰⁴³ This was quoted in chapter 3 A, but it would have made sense also in assistive robots in chapter 4. In any case, *see* Wolbring G. et al (2014) op. cit.

¹⁰⁴⁴ This is a general conclusion that has not strictly been mentioned before, but that it has come to our understanding in the light of rising literature on how to deal with ethical problems in the realm of robot technology when it is not very clear how we deal them in the human world. This was inspired by the course of Sandel, M. J. (2010). *Justice: What's the right thing to do?*. Macmillan.

¹⁰⁴⁵ Several quotes during the thesis, but mostly Stephan, A. (2015) op. cit., Tisseron, S. et al. (2015) op. cit., and the updated publication of Darling, K. (2016) op. cit.

¹⁰⁴⁶ Chapter 4, quoted Malle, B. et al. (2016) op. cit.

¹⁰⁴⁷ This relates to the Google patent op. cit. and also to user right's section in chapter 4.

General issues and challenges concerning justice for personal care robots

- Personal care robot technology might be helpful for a wide range of people¹⁰⁴⁸.
- Access to that technology that helps people in need should be made available in an equality basis.¹⁰⁴⁹
- Considering the cuts in the majority of European healthcare systems, producers might need to adjust to certain low-cost parameters so that any State could be provider of such technologies¹⁰⁵⁰.
- The general access to personal care robots could be framed under the article 35 EU CFR, i.e. right of access to preventive health care¹⁰⁵¹.
- Under any circumstance discrimination should take place, either in gender, race, sexual orientation or religion terms¹⁰⁵².
- Technological context might imply connection dependence and digital divide.¹⁰⁵³

3. Issues and challenges for person carrier robots

After having applied the care robot impact assessment for this type of robots, we conclude that future guidelines on personal care robots might have to include specific provisions for person carriers as their characteristics and context of use, characteristics, HRI, etc., largely differ from other sub-types of personal care robots. Here there are some areas of interest and concern as well as issues and challenges concerning person carriers to be considered within the lawmakers discussion.

Human-Robot Interaction in Person Carrier Robots¹⁰⁵⁴

- The HRI is physical because the user needs to seat or stand on it to be transported.

¹⁰⁴⁸ The lack of quantitative data makes this statement hard to justify the general benefit these devices can have. Although we agree on the fact that specific concrete devices might not deserve a general inclusion into the healthcare system (to not favor a company instead of another one), it is true that more general categories – lower-limb exoskeletons for instance – may bring positive consequences to the society and to the healthcare system.

¹⁰⁴⁹ This refers to the principle of justice in general, mentioned in chapters 3-4 in justice section.

¹⁰⁵⁰ This has been extracted from the introduction of this work, but it is true that the system lacks quantitative data on how good is this technology to proceed with such a requirement. Some companies do believe in low-cost technology, *see* <http://dynatech2012.com/home/>.

¹⁰⁵¹ The European Parliament is clear on its resolution when referring to the principle of justice: fair distribution of the benefits associated with robotic technology. *See* chapter 3B, justice section. Other corpuses support the access to medicine. Cfr. art. 25 Universal Declaration of Human Rights (UDHR), the art. 12 of the International Covenant on Economic, Social and Cultural Rights (ICESCR), the art. 24 of the Convention on the Rights of the Child (CRC), art. 5 of the Convention on the Elimination of all Forms of Racial Discrimination (ICERD), art. 12 and 14 of Convention on the Elimination of All Forms of Discrimination Against Women (CEDAW), and the art. 25 of the Convention on the Rights of the Persons with Disabilities (CRPD). At a European level, right to health is supported by art. 2 and 3 on the European Convention of Human Rights (ECHR) as well as the art. 11 of the European Social Charter that inspired also the art. 35 of the EU Charter of Fundamental Rights (EU CFR)

¹⁰⁵² *See* chapter 4, and in concrete the part on the discriminatory algorithms. *See* Miller, C. C. (2015) When Algorithms Discriminate: www.nytimes.com/2015/07/10/upshot/when-algorithms-discriminate.html?_r=1

¹⁰⁵³ Discrimination can come in monetary terms too. *See* chapter 2 in the presentation of the Care Robot Impact Assessment Model and chapter 4 justice section.

¹⁰⁵⁴ The description of the HRI can be found in chapter 3A, in special the robot type section.

- The interaction with the user is a direct consequence of the task to be carried out, not because it is its primary aim, i.e. the interaction is passive.
- Because they are task-oriented – and the task is to transport a person from A to B – they are not meant to socially interact with the user.
- Social interaction depends on the technology applied to the carrier (whether it has communication capabilities) and also on the capabilities of it and of the surrounding environment, i.e. if the device can climb stairs or if the device takes into account elevators in autonomous mode. The rest depends on the user.

Orientation of Person Carrier Robots¹⁰⁵⁵

- Person carriers are task-oriented, with a passive HRI and practically zero social interaction.

Typical Contexts of Person Carrier Robots¹⁰⁵⁶

- Indoor contexts will have to be adapted to the person carriers so that the device can properly work ensuring the safety of the user.
- Outdoor contexts, even if unstructured by nature, will have to be structured for the appropriate use of the device. Internet of Things platforms.
- Internet of Things can be a good way to structure both the indoor and the outdoor environment.
- Person carriers used in outdoor contexts will have to take into account several rules, e.g. traffic rules. Legal safeguards and protections might encounter similarities to some autonomous ground vehicles used in outdoor spaces.

Specific recommendations/issues/challenges concerning Safety in person carrier robots

- Navigation will have to include obstacle avoidance and smoothness of the action to protect the users. Person carriers will barely have to take into account proxemics¹⁰⁵⁷.
- Person carriers will have to face more and more non-mission tasks, especially if used in outdoor contexts¹⁰⁵⁸.
- Safety of the user will not only depend on the safety of the carrier, but also on the interaction with the environment (Internet-of-Things channel) and the interaction with the user (estimation and execution of the movement)¹⁰⁵⁹.

¹⁰⁵⁵ Ibidem.

¹⁰⁵⁶ The description of the HRI can be found in the context section of the chapter 3A.

¹⁰⁵⁷ This is because humans respond to the invasion of robots in a stronger manner than with other humans (Joosse, M. et al. (2014) op. cit.). The fact that wheelchairs are not meant to be interacting with humans in an active way might be a factor that prevents them to have to implement proxemics into their algorithms (only maybe some cultural differences, such as whether you need to travel on the right or on the left, depending if you are in London or not, for instance).

¹⁰⁵⁸ This can be found in chapter 3A, safety section. Indoor contexts provide a more adaptable and monitorable infrastructure so, the more carriers will be used outdoors, the more they will have to face non-mission tasks, unless it is a controlled environment – e.g. a carrier used in an open fair.

¹⁰⁵⁹ It is important to develop a culture of safety around these devices where not only the carrier needs to be technologically safe, but also the user uses it safely. Chapter 2 safety section.

- The protective stop should work also when the device detects anomalies in the transmission of data, i.e. to prevent hacking-attack related hazard situations¹⁰⁶⁰.
- The protective stop should incorporate communication capabilities so that person does not feel hopeless if he/she cannot move the carrier¹⁰⁶¹.
- Other alternatives such as preventing users from using it in public spaces could also be considered, although then their independence could be indirectly undermined¹⁰⁶².
- Cognitive aspects concerning the use of carriers are of crucial importance: feelings of hopeless after impossibility to move the carrier in a protective stop mode might entail frustration and anxiety¹⁰⁶³.
- Perceived safety is of paramount importance in person carriers as the user is being transported from A to B, in most of the cases autonomously¹⁰⁶⁴.

Specific issues and challenges concerning consumer robotics in person carrier robots

- Some person carriers – mainly wheeled passenger carriers – may be largely confused with wheelchairs, which fall under the medical device category/regulation¹⁰⁶⁵.
- Although person carriers are task oriented, the state of the art reveals that they do transform in other devices. Transformation categories should be carefully addressed, especially in the light of static standards¹⁰⁶⁶.
- In transformative robots, safety should be provided in the transition time between states and also in the remaining state¹⁰⁶⁷.
- If the transformation involves a new category of robot (from carrier to mobile servant robot) the safeguards from both categories should be applied.
- All the certifications and safeguards according to all the categories – after transformations – should be in place to protect the users.

¹⁰⁶⁰ This is a very important issue because protective stops are meant to prevent the robot from carrying out a task, which may endanger the user. On the contrary, there are no killer switch for violations of other rights, like in this case privacy. It has not been developed this as a concept but we do believe that all fundamental rights should be respected at the same level. Chapter 2 safety section.

¹⁰⁶¹ This is connected to the protective stop but it is not about it, but about something complementary to it. The inclusion of such capability would allow the person that had a problem to ask for help immediately. Thus, protective stop and embedded help/communicative capabilities should go hand in hand. Chapter 2 safety section.

¹⁰⁶² Sometimes there could be applied some technical restrictions into the carrier so that the carrier cannot go outside. Although this may undermine the independence of the user, it may be in alignment with the institution rules, for instance.

¹⁰⁶³ Any advent that could occur to the person in the protective stop mode could imply such state of mind of the person. These aspects that might be more typical of social robotic technology are going to have room also in simpler non-social robots which can be involved in desperation environments too.

¹⁰⁶⁴ Feeling secure using the device, namely, feeling that the user is in control, is a must. *See* chapter 3 A consumer robotics section.

¹⁰⁶⁵ This is crucial, especially in the light of the recent Medical Device Regulation (*see* chapter 1 last section). Until we do not have an automated category-system, safeguards should be applied according to the existing categories. Confusion of this type may, on the one hand, entail a lack of the appropriate safeguards; and, on the other hand, full strict liability to the producer, especially because certification agencies are not responsible for what they certify (*see* Le Monde (2012) Le label "TÜV", une institution en Allemagne op. cit.). *See* chapter 3 A consumer robotics section.

¹⁰⁶⁶ Concerning the categories, static standards may imply continuous interpretation, especially in a so-fast changing market. *See* chapter 3 A consumer robotics section.

¹⁰⁶⁷ This is what we mentioned in chapter 3 A consumer robotics section: a robotic person carrier that is in bed state should not start climbing stairs if that function is available in wheelchair state.

- The information of use might not be enough to protect users from this product.
- If the task of these devices can be perfected and there is no other cheaper solution to achieve this task (through other devices) and they can help mobility among elderly and disabled people, their market value is secured.
- Great expectations towards a general acceptance from the society can lead to frustrated projects, e.g. segways.

Specific issues and challenges concerning liability in person carrier robots

- These types of personal care robots might need the actual product liability regime, which includes an incorporation of the state the art¹⁰⁶⁸
- It will be important to solve what is the liability schema for autonomous person carriers¹⁰⁶⁹.
- The need to determine whether person carrier robots need self-/ mandatory insurance, a complementary insurance or only (extension of) guarantee for product defect¹⁰⁷⁰.

Specific issues and challenges concerning user rights in person carrier robots

- In order to improve its intended tasks, the person carrier will need to process large quantities of personal data, not only environmental/context/location-related data but also behavioral data, which is highly sensitive¹⁰⁷¹.
- It is not very clear how the data controller ensures informed consent in this particular behavioral data collection¹⁰⁷².
- The use of Internet of Things environment will challenge lots of the data protection principles: consent, purpose, data minimization, data access, etc.¹⁰⁷³
- The protective stop should work also for data collection prevention¹⁰⁷⁴.

¹⁰⁶⁸ As quoted in Chapter 3 A, liability section, *see* Article 7 (e) of the European directive 85/374/CE on the approximation of the laws, regulations and administrative provisions of the Member States concerning liability for defective products. According to this article: “The producer shall not be liable as a result of this Directive if he proves (...) that the state of scientific and technical knowledge at the time when he put the product into circulation was not such as to enable the existence of the defect to be discovered”.

¹⁰⁶⁹ This goes in line with the latest EU Parliament resolution *op. cit.* when it refers to the responsibility gap: “in the scenario where a robot can take autonomous decisions, the traditional rules will not suffice to activate a robot's liability, since they would not make it possible to identify the party responsible for providing compensation and to require this party to make good the damage it has caused”. It will be of primarily importance to determine what is the responsibility for specific types of robotic technology.

¹⁰⁷⁰ This also relates to the EU Parliament resolution *op. cit.*

¹⁰⁷¹ Similar to autonomous car, the data that will be processed will be also from an identifiable person, and also sensitive: it will be possible to know routines and habits of certain person. In some cases this can improve device performance – in elderly care situations – but it should be restricted.

¹⁰⁷² *See* chapter 3 A section user rights. Not because a person buys a person carrier it means that it gives the informed consent directly, especially because an express written format is needed.

¹⁰⁷³ Internet of things creates a platform so different devices – from different providers – can communicate. These communications may entail an exchange of data that might not be transparent to the user in terms of access for instance.

¹⁰⁷⁴ This is mentioned in the general aspects for personal care robots.

- Navigation should avoid the collection of information of third users, especially if the carrier includes cameras for obstacle avoidance¹⁰⁷⁵.

Specific issues and challenges concerning autonomy in person carrier robots

- The autonomous mode of person carrier can clash with the intentions of movement of the user, and there will have to be a trade-off between the free will of the person and its safety¹⁰⁷⁶.
- In some occasions the system will need to incorporate a balance between compelling interests (decide whether it prevails the free will of the user or his/her safety) in special regard to vulnerable parts of the society.¹⁰⁷⁷
- It is crucial to understand all the dimensions of the protective stop. Mapping the most compelling actions linked to it should be desirable: the need to decide whether the carrier should stop or not, if doing so is less dangerous than continuing performing the task¹⁰⁷⁸; in case of doubt, protective stop accompanied by an emergency call to the competent authorities¹⁰⁷⁹.
- It should be considered whether in shared autonomy mode, a driving test could improve efficiency of the task and provide more safety, and how this should be modeled for impaired users¹⁰⁸⁰.

Specific issues and challenges concerning dignity in person carrier robots

- The bulkiness of the carrier can provoke an isolation scenario, but this is common to other kinds of carriers, e.g. wheelchairs.¹⁰⁸¹
- The device should be made transportable and integrated¹⁰⁸².

¹⁰⁷⁵ Obstacle avoidance can be done in different ways. If the carrier incorporates vision camera to avoid obstacles, any information concerning third users (that might be considered as an obstacle to be avoided) need not to be recorded.

¹⁰⁷⁶ Although at a different level than autonomous cars, person carriers may be involved in certain scenarios where the task (transporting the person from A to B) might not be possible to be carried out due to several ¹⁰⁷⁷ Chapter 3A autonomy section. This might relate to the scenario described in the chapter, but also to a larger extent of events in which there will necessarily have to be a trade-off between what the user wants, including whether this is part of his/her will, whether the user was mistaken (and s/he could not go on because there were some stairs and s/he did not see them), and also his/her security.

¹⁰⁷⁸ Mentioned in chapter 3A, this refers to the situation where, for instance, it is better crossing a yellow traffic light than stopping, at risk to be hit from behind. If the safety of the user is to be protected, there might be the need to clarify what to do in situations in which the protective stop mode could cause further dangerous situations than just carrying the task.

¹⁰⁷⁹ This relates to the scenario when a person feels hopeless because s/he is left alone somewhere without the possibility to move the carrier. Chapter 3A.

¹⁰⁸⁰ This relates to the research conducted at Dalhousie University in Canada (*see* www.wheelchairskillsprogram.ca/eng/index.php). Although referring to wheelchairs, this might be extrapolated to person carriers. If a driving test ensures better user performance, this might be helpful to avoid responsibilities of the producer (shared responsibility) and might help users also get better.

¹⁰⁸¹ This is a common problem among wheelchairs, and it is not very clear whether the producer should be responsible for offering an easier carrier or whether it is the user who, knowing in advance the characteristics of it, decides to buy it or not. Chapter 3A.

¹⁰⁸² This relates to the possibility to integrate the carrier within the environment where is meant to work. This could ensure smoothness of the actions and a better user experience. Chapter 3A.

- The use of autonomous collective person carriers might endanger existing public transportation jobs¹⁰⁸³.

Specific issues and challenges concerning
ethics in person carrier robots

- There will be an ethical discussion on several aspects concerning person carriers, e.g. what should the carrier do if the user asks it to fall downstairs¹⁰⁸⁴.
- If robotic carriers include a social interface, then all the modules referring to social robots might apply¹⁰⁸⁵.

Specific issues and challenges concerning
justice in person carrier robots

- The access of this technology to the general public is uncertain and depends largely on the type of carrier¹⁰⁸⁶.
- Up to now, segways have been largely extended over the population, even if not always for “personal care” purposes¹⁰⁸⁷.
- The state should evaluate whether these devices need to be available to the general population or not, and what are the conditions for getting them¹⁰⁸⁸.

4. Issues and challenges for physical assistants robots

After concretizing the current care robot legal framework with precise information of robot type and the context of insertion, some relevant knowledge has been collected. This knowledge identifies the legal aspects involved in this technology and provides concreteness to the general principles. Some differences between physical assistant robots and person carriers became more evident after the analysis, even if both are non-social robots because they do not interact normally on a cognitive/social manner with the user; and both estimate and execute a movement. Lawmakers shall take into account the following aspects in their discussions:

¹⁰⁸³ Although we have not addressed public multi-person carriers, current investment from big companies such as IBM Watson (*see* www.engadget.com/2016/06/16/olli-driverless-ev-local-motors-ibm-watson/) could entail a decrease of the number of jobs performed by humans. This might have to be taken into consideration in whether, from the policy perspective, is better the reduction of public transport accidents or maintaining the jobs of the drivers of such transport.

¹⁰⁸⁴ This relates to the work of Sharkey, N. and Sharkey, A. (2010) *op. cit.*, and wonders what should the carrier do in such a situation. An ethical discussion on all these aspects could bring clarity to the topic. Chapter 3 A, ethics section.

¹⁰⁸⁵ This relates to the work of Hegel et al. *op. cit.* when we quoted in the first chapter. In theory person carriers do not offer a sophisticated presence nor interact with the users on a higher cognitive level. If that was the case, then a lot of modules concerning social robots (in this thesis referred as mobile servant robots) might apply, such as social awareness.

¹⁰⁸⁶ This is important because in this thesis we have referred to wheeled passenger carriers, which might not be the only type of carrier. If there will be more and more public transportation that meet the characteristics, then it can happen as autonomous underground: it is implemented without a public general consultation.

¹⁰⁸⁷ Segways have been used for recreational purposes and not really for *personal care* reasons. This might have to be taken into account when designing the policy. Chapter 3 A justice section.

¹⁰⁸⁸ This refers to the possibility that the State reimburses the person carrier, as it happens with current wheelchairs. A system should be implemented on what are the conditions of such reimbursement.

Human-Robot Interaction in Physical Assistant Robots¹⁰⁸⁹

- Physical assistant robots have physical HRI because the device is mostly fastened to the human body (restraint-type), and works with a symbiotic movement with the user.
- HRI is more internal than external: physical empowering close to cyborg enhancing
- The social interaction remains subordinated to the physical support ideally hidden not to interfere with ordinary social interactions.

Orientation of Physical Assistant Robots¹⁰⁹⁰

- Physical assistants are task-oriented, with a higher HRI and a little social interaction.
- Physical assistants enhance user's social interaction even if it is not primarily part of its task: the robotic device remains neutral in this regard.

Typical Contexts of Physical Assistant Robots¹⁰⁹¹

- Physical assistants are the robots with more probability to be considered medical device. This means that the context of use will not matter the most when deciding which regulation applies (machinery directive or medical device directive), but the inner functionalities of these devices will (probably) make it medical device.

Specific issues and challenges concerning safety in physical assistant robots

- In lower-limb assistants, safety may involve aspects in the estimation of the movement, and in the performance. This may include cognitive aspects – perceived safety¹⁰⁹².
- The device may have to understand that unwanted movements – coughs, sneezes or spasms – do not count as “estimation of movement” and, thus, may not perform a movement¹⁰⁹³.

¹⁰⁸⁹ The description of the HRI can be found in chapter 3B, in special the robot type section.

¹⁰⁹⁰ Ibidem.

¹⁰⁹¹ The description of the HRI can be found in the context section of chapter 3B. This goes in relationship with the new medical device regulation. In May 2017 they will be published in the Official Journal, but the texts are already available at: data.consilium.europa.eu/doc/document/ST-10728-2016-REV-4/en/pdf.

¹⁰⁹² Physical assistant robots may be the first ones that truly show how important the cognitive side of these devices is. In this case, the fear from falling is crucially important although there are no clear guidelines on how to diminish such fear, *see* Olivier, J. op. cit. These cognitive aspects may relate to the *perceived safety* defined by Salem et al. (2015) op. cit., but they might take a different form from social robot technology. Overall, *see* chapter 3B safety.

¹⁰⁹³ Safety of the user at this respect is of primarily importance. In the light of devices that may be available to the general public, all these actions may have to be integrated into the system so that a person that is waiting the bus stop, for instance, does not start walking because s/he sneezed.

- To ensure the device tackles the core aspects of the disorder/disability, the device should be personalized¹⁰⁹⁴
- Safety should not be compromised by the price of the device, nor it should depend on the personalization of the device¹⁰⁹⁵.
- In the light of activities of the daily living, lower-limb exoskeletons may be strongly recommended to include terrain recognition system¹⁰⁹⁶.
- The device should incorporate safeguards to avoid impossible tasks, e.g. preventing climbing stairs if it has no stair-climbing function¹⁰⁹⁷.
- It is crucial that the protective stop is in a reachable distance for the user and that its functioning does not entail a higher risk for the safety of the user¹⁰⁹⁸.
- Perceived physical safety in physical assistants – e.g. fear from falling – may be of crucial importance. The degree of importance may vary depending on countless aspects: person, degree of impairment, percentage device assistance¹⁰⁹⁹.
- Push recovery and stability algorithms for lower-limb physical assistants could be considered although it should be modeled for the case of vulnerable parts of the society, such elderly.¹¹⁰⁰
- The use of a curve of registration (an already available gait pattern) to provide faster reliability will have to be secured at most, and balanced with the user needs¹¹⁰¹.
- Safety measures shall not only be directed to the prevention of the accident but also on how to manage the event occurs. At this regard, incorporating an airbag to lower-limb devices could be considered¹¹⁰².

Specific issues and challenges concerning consumer robotics in physical assistant robots

¹⁰⁹⁴ Nowadays companies are not offering many sizes of their exoskeletons. In fact, they might not be available for overweight people either. This is important because these aspects may be crucial to tackle the need of the person. Chapter 3B safety.

¹⁰⁹⁵ This refers to many aspects mentioned in the safety section of Chapter 3B. The most relevant, to the latest advancements in 3D printing (mentioned in justice section), but connected to the chart of Exoskeletons versions presented by Virk, G. S., Haider, U., Indrawibawa, I. N., Thekkeparampudom, R. K., & Masud, N. (2014, July). Op. cit., where it is clearly stated that there are different characteristics – also relating to safety – dependent to the type of device.

¹⁰⁹⁶ Although it may increase the time response of the device, including a Terrain Recognition System as introduced by F. Zhang et al. (2011) op. cit., could help increment the safety of the user that may not know or feel the difference between different terrain types. This goes in line to the different devices proposed by Virk, G.S. op. cit. above.

¹⁰⁹⁷ This is a conclusion we arrived in the course of the chapter 3B, and in connection with the previous 3A chapter with stair-climbing carriers. It might happen that the user wants to go (or to try to go) upstairs using the exoskeleton, but evidently the device is not prepared for that. While the user may be responsible for such a decision, incorporating such a limitation into the system by default could be of help.

¹⁰⁹⁸ This relates to the work of Baud, R. et al. (2016) op. cit. and Olivier, J. (2016) op. cit., who incorporated the protective stop behind the device, a place that may be practically unreachable by any user. This relates also to ISO 13482:2014 because it is a requirement.

¹⁰⁹⁹ This relates, first, to the cognitive aspects mentioned before, but also to ISO 13482:2014 op. cit. its section 6.1.2.2.1. includes two types of devices: devices the user cannot overpower the personal care robot, and those physical assistant restraint type that provide low powered physical assistance and, consequently, the user can overpower the personal care robot. If the person may overpower the robot, this may play a role at this regard.

¹¹⁰⁰ Jatsun, S. et al. (2017) op. cit. are working on this. The inclusion of the stability algorithms from Boston Dynamics is our idea, which could be made as a requirement for this type of assistants.

¹¹⁰¹ This relates to Virk, G. S. (2014) op. cit. *see* chapter 3B safety.

¹¹⁰² This relates to this patent: US 20140005577 A1 Airbag for exoskeleton device

- Consumer robotics is directly affected by the extension of the medical device regulation that will probably enter in force in Europe soon¹¹⁰³.
- As the device works on a symbiotic manner with the user's movement, user-centered design might have to be mandatory¹¹⁰⁴.
- The information of use included with the device might not be enough to protect users from this product – a training may have to be provided too¹¹⁰⁵.

Specific issues and challenges concerning liability in physical assistant robots

- Liability scenario may imply the interconnection of the environment, the subject and the device itself and thus responsibility may be difficult to allocate. Clear protocols on division of responsibility between devices and providers might have to be clear so that responsibility can be truly allocated¹¹⁰⁶.
- Compliance with current standards – ISO 13482:2014 – may not avoid further responsibility in the light of the medical device reform¹¹⁰⁷.
- There is the possibility that people have problems in the future due to the wrong use of this technology, which would mean that liability could be prospective¹¹⁰⁸.
- It should be clear what does the state of the art include concerning exoskeletons to avoid responsibility according to the product liability directive, for instance, push recovery and stability algorithms or also other legal/ethical aspects¹¹⁰⁹.
- Specific testing zones for exoskeletons are needed to fully understand the drawbacks and potentials of this technology¹¹¹⁰.
- Although data portability may be for data protection matters, it should be clear who is responsible to implement such readable format into the system and how this protects security at the same time¹¹¹¹.

Specific issues and challenges concerning user rights in physical assistant robots

¹¹⁰³ As we mentioned in chapter 1, and also in the context section of chapter 3B.

¹¹⁰⁴ Unfortunately at the beginning devices are bulky and heavy, and might not be personalized. The need to offer personalized devices becomes more evident when advancements in technology are available. Not only companies right now are using different sizes for different people, but also 3D printing may play an important role to offer personalized devices. Not only due to cosmesis reasons, but also for safety reasons, having to provide a personalized device for a personalized person may be mandatory in the future.

¹¹⁰⁵ The complexity of such devices, including the high risk they entail (e.g. may produce a fall) may imply the inclusion of training sessions before its usage.

¹¹⁰⁶ This will be even more blurred when it comes to the use of Internet of Things platform that interconnects all of these devices. This is mentioned by Kuan Hon, W., Millard, C. and Singh, J. (2016) op. cit.

¹¹⁰⁷ Already mentioned before.

¹¹⁰⁸ This relates to Datteri, E. (2013) op. cit. that mentioned that users could not provide reliable feedback to the creators of the robot to evaluate its correct performance and, thus, had problems in the future because their muscles were activated abnormally. This is particular relevant in this scenario because an accident with a person carrier may be more immediate than in this case. This may also be relevant for mobile servant robots.

¹¹⁰⁹ Up to date there is no research on what does this state of the art include, although the product liability directive is clear at this regard: “the state of scientific and technical knowledge at the time when he put the product into circulation was not such as to enable the existence of the defect to be discovered”. The latest advancements in stability algorithms from Boston Dynamics, but also push recovery algorithms from Jatsun, S. et al. (2017) op. cit. could be of help at this regard. The latest part of the sentence refers to the latest BS 8611:2016 op. cit.

¹¹¹⁰ This could help to do an ex ante screening of not only safety but also other aspects. See Chapter 3B liability.

¹¹¹¹ Chapter 3B, user rights section.

- Physical assistant robots will be involved in bodily privacy, which is not limited to restricting physical access to the body, but also to restricting and controlling information about the body (e.g., health or genetic information)¹¹¹².
- The collection of data might be a *condition sine qua non* to improve these devices. A balance between quantitative data and user protection should be ensured so both can benefit from each other¹¹¹³
- The right to data portability may get a lot of attention with exoskeleton technology, having the user the need to be provided with the data that governs his/her device so that it can be transferred to a new one.¹¹¹⁴
- At this regard, compatibilities between systems will have to be carefully addressed.¹¹¹⁵
- Due to the interaction between the user, the environment and the device, if the devices use a cloud platform, all the particularities connected to it will have to be addressed¹¹¹⁶.
- Training centers will be data hubs that will collect data from the user, which is highly sensitive. All the biomedical data will have to be protected and third uses of data shall be carefully addressed¹¹¹⁷.

Specific issues and challenges concerning autonomy in physical assistant robots

- The autonomous mode of person carrier can clash with the intentions of movement of the user, and this might have fatal outcomes – as the device is fastened to the user’s body.¹¹¹⁸
- Reversibility may be impossible in the case of lower-limb physical assistants, as the action may be impossible to be undone, e.g. a fall.¹¹¹⁹
- The higher the symbiosis with the user’s movement, the higher the user’s dependency on the device. This could promote autonomy, or undervalue it once the device does not work¹¹²⁰.

¹¹¹² This relates to the article of Koops, et al. (2016) op. cit. which made a revision of the different parts of privacy.

¹¹¹³ This relates to the work of Borenstein, J. and Arking, R. (2016) op. cit. but also to Admoni, H. et al. (2012) even if relating to autistic research. The lack of quantitative data may hamper further innovation not only technically but also policy related.

¹¹¹⁴ This is our conclusion after writing the scenario for physical assistants. But in the case of a training center it should be clear who is collecting the data, in what format and how the user can have access to that, and how can s/he transfer it to a new center, to a new device etc. In the future, if training centers are largely available, it will not be surprising that a person wants to move his/her data to a new center if s/he has moved to another town for instance.

¹¹¹⁵ If the data portability is finally enforced, the European institutions will have to give more clarity on what is the content of such right and what are the protocols to follow. This may include general recommendations from the European Data Protection Supervisor or specific ones.

¹¹¹⁶ Similar to Hon, W. K., Millard, C., & Singh, J. (2016) op. cit.

¹¹¹⁷ This relates to the General Data Protection Regulation.

¹¹¹⁸ This is a general safety concern that can be related to the autonomous behavior of the device. Ex-ante test bed, and training session may diminish this risk.

¹¹¹⁹ This relates to the EU Parliament Resolution (2017) op. cit.

¹¹²⁰ See chapter 3B autonomy section.

- If the device gives cognitive support to the user this may affect user's autonomy.¹¹²¹

Specific issues and challenges concerning dignity in physical assistant robots

- Dignity will play a major role in these devices because exoskeletons aim at being invisible to the eyes of the user (and to the eyes of people seeing them) not only in its literal sense, but in a more general sense (because it does not impede the social interactions that the persons will have in the future).¹¹²²
- Importance of cosmesis aspects so that the users avoid the feeling of a Christmas tree due to the sensors¹¹²³.
- Exoskeletons do not pretend to substitute the human caregivers but to enlarge the possibilities of rehabilitation and to make the up-right position walking normal again in disabled users¹¹²⁴.
- The creation of training centers for this type of technology might encourage the human-human interaction in many various beneficial forms either from the users or the caregivers¹¹²⁵.

Specific issues and challenges concerning ethics in physical assistant robots

- The fact that this movement is symbiotic, the devices works in a physical empathy with the user's movement, which may force the creator of the robot to take into account also dignity and ethics¹¹²⁶.
- Secondary users, either trainers or caregivers, might have to be trained too to ensure the correct performance of the device¹¹²⁷.
- Relation between price and safety might not be ethical¹¹²⁸.

Specific issues and challenges concerning justice in physical assistant robots

¹¹²¹ Ibidem. Amodei et al. (2016) op. cit. mentioned that systems that put a recommendation to the user may not have that many implications in the real world as other systems, like robots that interact in the physical world. This might get important in the case of exoskeletons that provide such cognitive support to the user.

¹¹²² Recent advancements – ExoSuits from Harvard – may be very beneficial for the dignity of the user, as it may contribute to decrease the feeling of abnormality when using a “bulky” exoskeleton, because it will be integrated as a piece of clothe into his daily living. This might be similar to what happened time ago with braces, that now they look practically invisible. Although it might not be a strict requirement, producers of such technology should take these aspects into account.

¹¹²³ This refers to what we have just quoted, and to the work of Tucker et al. (2015) op. cit.

¹¹²⁴ This relates to the care-robot provision of the Resolution of the EU Parliament op. cit. and also to chapter 3B dignity section.

¹¹²⁵ Ibidem.

¹¹²⁶ This also relates to the BS 8611:2016 op. cit. and the code for engineers of the EU Parliament Resolution (2017) op. cit.

¹¹²⁷ This relates to the lack of protocol for the use of DaVinci surgeon robot. There is no protocol for exoskeleton use and this might be needed.

¹¹²⁸ This relates to the different types of devices presented by Virk, G. S., Haider, U., Indrawibawa, I. N., Thekkeparamadam, R. K., & Masud, N. (2014, July). Op. cit.

- Low-cost for this technology is feasible (e.g. using 3D printing) and therefore should be promoted. Appropriate programs could be destined to this goal¹¹²⁹.
- Low-cost (or cheaper versions of the robot) shall not entail, by any means, a reduction of the safety of the user¹¹³⁰.

5. Issues and challenges for mobile servant robots

Mobile servant robots are social robots because they communicate with the users without necessarily interacting physically with them. This feature affects the HRI and challenges the personal care robot current industrial standard.

Human-Robot Interaction in Mobile Servant Robots¹¹³¹

- Even if there are contrasting opinions in literature differs regarding the definition of social robots, mobile servant robots differ from the other personal care robots – person carrier and physical assistant – because the interaction happens at the physical and at the cognitive level.
- The social interaction happens between the robot and the human or between humans through the robot.
- Due to the social interaction, navigation includes a shift from proxemics to social awareness.
- It is probable that future mobile servant robots will be totally focused on user interaction and that will convey a feeling of companionship or of mutual respect because other tasks will be performed by cheaper devices or smart appliances.
- In some cases the sporadic HRI can turn into a relationship, depending on the long-term use of the robot.

Orientation of Mobile Servant Robots¹¹³²

- Mobile servant robots are user- and socially-oriented
- They are also task-oriented, and they might not be fully multi-tasking yet.

Typical Contexts of Mobile Servant Robots¹¹³³

- Mobile Servant robots can be found at airports, or supermarkets, but the more and more will be found in personal environments.
- For a better performance, mobile servant robots will be included in a structured environment, where the robot will be a thing of the Internet-of-Thing structure.
- This will clash with other cheaper ways to solve certain problems provided by the same Internet of Things structure. If tasks can be carried out through other cheaper solutions, the success of mobile servant robots will be compromised.
- As long as tasks are defined, ethical problems can be identified and addressed.

¹¹²⁹ Chapter 3B section justice. *See* also Campbell, T. et al. (2011) op. cit.

¹¹³⁰ This is what we referred before in the relation between price and safety.

¹¹³¹ The description of the HRI can be found in chapter 4, in special the robot type section.

¹¹³² *Ibidem*.

¹¹³³ *Ibidem*.

Specific issues and challenges concerning safety in mobile servant robots

- The robot should be designed in a way that understands natural language. Special attention should be done in bilingual communities, with a dialect, etc.¹¹³⁴
- Trust needs to be built upon the reliability of the robot's behavior, which might involve not only physical activities (such as bringing a glass of water to the person) but also to the non-physical activities, such as different purchases and transactions done through the robot (because the user has created a shopping list with the help of the robot and the robot sends the command to the nearest supermarket), but also intellectual activities done with the user (collaborative tasks, playing games, entertaining, the person needs to be sure that the robot will play chess and will not throw away the pieces because he lost, for instance)¹¹³⁵.
- Designers should introduce trustworthy system design principles across all aspects of a robot's operation, for both hardware and software design, and for any data processing on or off the platform for security purposes¹¹³⁶.
- Safety should include not only proxemics but also social awareness¹¹³⁷.
- At this point of research it is not very clear when the robot should start a conversation or how it should maintain it.¹¹³⁸
- It is crucial to detect whether the robot has a virus or not, and whether that can affect the safety of the user¹¹³⁹.
- Object avoidance will have to be ensured when the mobile servant robot travels to perform the intended tasks¹¹⁴⁰
- Reinforcement learning could improve safety in mobile servant robots but at a testing zone phase, not with the user¹¹⁴¹.

Specific issues and challenges concerning consumer robotics in mobile servant robots

- Consumer trust is formed by company representations, and current robot companies do deceptive and misleading practices by showing videos of capabilities that current robot technology cannot do¹¹⁴².

¹¹³⁴ The robot might have to be exposed to different dialects, accents, so that the safety of the user is not compromised because the robot have not understood correctly the command. *See* Collins, E. (2015) op. cit.

¹¹³⁵ This relates to the work of Salem et al. (2015) op. cit. but also modeled in our case with mobile servant robots. *See* safety section chapter 4.

¹¹³⁶ *Ibidem*.

¹¹³⁷ Defined already by Rios-Martinez, J. (2015) op. cit.

¹¹³⁸ Satake, S. et al. (2009) op. cit. and Michalowski, M. et al. (2006) op. cit.

¹¹³⁹ *See* Pistono, F. and Yampolskiy, R. V. (2016) op. cit.

¹¹⁴⁰ This might get trickier when it comes to personal dwellings, which may be unstructured and not always the same.

¹¹⁴¹ This relates to the problem we explained with the use of reinforcement learning and the Google Patent 2015 op. cit.

¹¹⁴² Hartzog, W. (2015) op. cit.

- The robot needs to present itself to the user as safe both in physical terms, that is, that the human will not be hurt by the robot; but also in psychological ones¹¹⁴³.
- Designers should introduce trustworthy system design principles across all aspects of a robot's operation, for both hardware and software design, and for any data processing on or off the platform for security purposes¹¹⁴⁴.
- At this regard, there are no available guidelines on cognitive HRI¹¹⁴⁵.

Specific issues and challenges concerning liability in mobile servant robots

- If the robot can perform/finish tasks on behalf of the user, division of responsibilities should be clearly defined¹¹⁴⁶.
- The concept of reversibility should not be used to undo illegal actions and avoid responsibilities, especially in those crimes where it is punished the intention of a crime¹¹⁴⁷.

Specific issues and challenges concerning user rights in mobile servant robots

- Mobile servant robots will be involved in many types of privacy issues, in part because they will co-habit with humans and will be integrated into their lives¹¹⁴⁸.
- The sporadic HRI that this kind of robots can have in public spaces will turn into a relationship that is likely to be multi-modal as well as evolving over time once they will be in personal environments¹¹⁴⁹.
- If robots are to be co-habiting with humans, awareness of the collected data, informed consent, legitimate purpose, will be challenged¹¹⁵⁰.
- Mobile servant robots will have to process large quantities of personal data, including spatial and behavioral data, relying on cloud computing platforms (referred to as cloud robotics), which can largely affect data protection and responsibility¹¹⁵¹.

¹¹⁴³ This relates to the work of Salem et al. (2015) op. cit. but also to the EU Parliament Resolution (2017) op. cit. when it says that the user shall be entitled to use the robot without fear of physical or psychological harm.

¹¹⁴⁴ Ibidem.

¹¹⁴⁵ Ibidem.

¹¹⁴⁶ This relates to the fact that mobile servant robots are the only type of personal care robots that perform tasks for the user (not allow the user to perform the tasks). This, combined with M from Facebook that allows to finish started actions from the human to be finished by the system, will make reconsider which is the division of responsibilities among the actors. This will relate to contractual issues. See Chapter 4 section liability.

¹¹⁴⁷ Chapter 4, section liability.

¹¹⁴⁸ This is the intention of several companies, e.g. Jibo. The transition between interaction and relationship will make privacy be at the core of the challenges. See user rights section in chapter 4.

¹¹⁴⁹ Benyon and O. Mival (2010) op. cit.

¹¹⁵⁰ This is a consequence of the interaction to relationship shift.

¹¹⁵¹ This might have to be explored in the future. This relates to the scenario explained when the robot uploads information of a certain robot behavior up to the cloud and then other robots learn that behavior. We wondered in that section what could happen when the uploaded behavior is illegal in other countries, and whether there will be a general obligation to avoid such learning processes. See chapter 4, user rights section.

- Special attention to the robot processing emotional data – i.e. mood, emotions, as this type of data has not been very often collected before¹¹⁵².
- The link between emotional data and biometrical data should be carefully used as it can lead to unfortunate scenarios¹¹⁵³.
- Technological illiteracy might have to be taken into account when it comes to security¹¹⁵⁴.
- Balance between monitoring and user protection will have to be ensured when it comes to companion robots with vulnerable parts of the society¹¹⁵⁵.
- If the robot includes applications, it should be ensured that privacy compliance is produced by both the robot creator and the application developer¹¹⁵⁶.

Specific issues and challenges concerning autonomy in mobile servant robots

- While independence is called into question because the user does not any longer satisfy personal needs by him/herself, autonomy will play a major role in mobile servant robots because it will be the user that will make the commands to the robot based on his/her decision¹¹⁵⁷.
- Systems that simply output a recommendation to human users, such as speech systems, typically have relatively limited potential to cause harm. By contrast, systems that exert direct control over the world, such as machines controlling industrial processes, can cause harms in a way that humans cannot necessarily correct or oversee¹¹⁵⁸.
- There might be the need to create automatic decision-support systems in order to help the user decision-making process¹¹⁵⁹.
- Attention should be drawn to the "finish task" function in certain robotic systems and how this would undermine (or not) the autonomy of the user¹¹⁶⁰.

Specific issues and challenges concerning dignity in mobile servant robots

¹¹⁵² There is not much research on what constitute *emotional data* beyond sensitive information. With current technology there are many intangible factors that can be measured, such as fear, or happiness. Beyond the fact that they will be personal and highly sensitive data, there is the question on whether robots should know the truth behind certain biological reactions (e.g. when your heartbeat accelerates and it refers to fear) or not. *See* chapter 4 user rights.

¹¹⁵³ *Ibidem*. Moreover, knowledge at this level could entail the creation of the perfect liar detector, which could be perversely used by authorities.

¹¹⁵⁴ A patient with moderate to severe dementia might find difficult to understand how to use fingerprint recognition biometrics for authentication purposes. These usage difficulties in the user, jointly with their frequent age-related technological illiteracy, may open breaches for illicit activities by third parties such as unauthorized authentication, or identity verification. This should be controlled.

¹¹⁵⁵ *See* chapter 4 user rights section.

¹¹⁵⁶ *Ibidem*.

¹¹⁵⁷ This is in relation to the UN Convention on the Rights of Persons with Disabilities, *op. cit.* *See* also Regulating Robotics Robolaw Project *op. cit.*

¹¹⁵⁸ This refers to the reinforcement learning, and the Google Patent *op. cit.* case. This paragraph is extracted from Amodei et al. *op. cit.*

¹¹⁵⁹ This might be unrealistic in certain cases, for instance in person carriers, when the system might have to react directly for the user, to avoid an accident for instance. In the case of mobile servants, it could be used as a prior requirement before the robot performs a task that has not clearly understood.

¹¹⁶⁰ This relates to M of Facebook previously mentioned.

- Social robots (mobile servant robots basically) could involve isolation because they provide a sophisticated presence¹¹⁶¹
- The inclusion of care robots can decrease human care and by extent human contact, so communication capabilities and human-human interaction programs should be implemented¹¹⁶².
- Robots will then be affectively interactive agents: instead of reproducing the physiology of humans' emotions, the aim is to coordinate human's emotions with robot actions¹¹⁶³.
- Similar to a seed that turns into a tree, which is not a tree when it is a seed, and it is not a seed when it is a tree, the relationship between the human and the robot demands for a life-cycle protection¹¹⁶⁴.
- Although it is not very likely that care workers and home carers are not going to be automatized, the truth is that scientific data states that this kind of job is 40% likely to be computerized¹¹⁶⁵.
- Human touch cannot be replaced¹¹⁶⁶.

<p>Specific issues and challenges concerning ethics in mobile servant robots</p>
--

- A robot should operate according to the local national and international ethical standards¹¹⁶⁷.
- Those who design, use and control these kinds of robots may also be required moral agency and emotions in the future¹¹⁶⁸.
- Teaching the robot to say "no" might have to be considered to avoid spoilt behaviors from the users that could badly influence the real world¹¹⁶⁹.
- As the technology advances, the use of quantum computing will be preferable as much more data will be able to be processed and maybe more than just a simple binary¹¹⁷⁰.

¹¹⁶¹ It is true, the insertion of robot technology may imply a decrease in the human-human interaction as the EU Parliament Resolution (2017) op. cit. mentions, but this will largely depend on the person and on other factors. Does the mobile phone decrease human-human interaction? Some will argue that yes, some will argue that the interaction is then transformed in another way of interaction.

¹¹⁶² This could be a general solution to avoid the envisaged problem by the EU Parliament.

¹¹⁶³ This might relate to the concept of collaborative agents, *see* Scheutz, M. (2015) op. cit.

¹¹⁶⁴ This is a metaphor of our own creation, that tries to reflect that the safeguards that might be applied to robot technology might vary over time, especially if the robot learns over time. *See* chapter 4.

¹¹⁶⁵ Frey, C. B. and Osborne, M. A. (2013) op. cit. There should be checked the latest information at this regard, because there has been a lot of discussion on whether robot technology would take over certain jobs or not since 2013.

¹¹⁶⁶ This relates to the EU Parliament Resolution (2017) op. cit.

¹¹⁶⁷ This relates to the EU Parliament Resolution (2017) op. cit., although it is not very clear how this could be modeled in the case of mobile servant robots.

¹¹⁶⁸ This is referent to the work of Coeckelbergh, M. (2010) op. cit. This may go in line with the use of codes of conduct by workers.

¹¹⁶⁹ This is just a personal conclusion that we arrived when realizing that the fear of robots as slaves was rising. Blanco, R. (2013) op. cit.

¹¹⁷⁰ We do not have a particular quote for this but it might be interesting how this technology evolves and how then robot technology, powered by quantum computing, can evolve.

Specific issues and challenges concerning
justice in mobile servant robots¹¹⁷¹

- Low-cost technology should be a must
- Right to benefit from this technology for those more in need.

¹¹⁷¹ There is not that much new on this section concerning the availability of these devices to the general population. Quantitative data might help States decide whether to invest money in these devices or not.

CONCLUSIONS

Solving The World's Biggest Problems Takes Ensembles, Not Soloists. Jeffrey Walker.

1. Achieved goals concerning the methodology

The legislative order frames in general the rules of power and conduct of the society, i.e. establishing rights and obligations to the subjects within the system, and evolves and develops as the society evolves. Technology development represents the progress in science, which challenges in many ways the boundaries of the application, the interpretation and the development of law. As a general fact, technology evolves faster than law.

Legislation concerning robots is in turmoil, and this thesis tried to address the challenges that developments in robot care technology may pose to Law. Personal care robots may have both pros and cons, and they require careful regulatory attention. This becomes especially evident when it comes to the transition from the *in silico* and *in vitro* phases, i.e. concept, design and creation of the (prototype of the) robot, to the *in vivo* testing and the actual implementation and/or commercialization of the robot; and only private actors have regulated such developments. Of note, regulation is fundamental to preserve constitutional rights and principles such as to/on safety/life, privacy (i.e. data protection), dignity, autonomy and justice, which might not be found in private legislations.

Due to the novelty of practices and impacts, there might be unclear rules and grey areas of legal ambiguity on the development of such robots – there might be no immediately applicable legal rule or precedent to the case. This might be in part because, at early stages of technology, developing hard law regulation may not make sense as impacts and concerns may be unclear and the risk of overregulation may abound. Researchers and robot creators, however, may be interested in continuing developing their technology in any case, and might want to know the regulatory framework that allows such technological development. Because of that, a step-by-step dialogue on emerging guidelines between different stakeholders would be a sensible approach. Such guidelines could help bring clarity on the liberty space – in terms of possibilities and constraints – that a particular legal order offers.

The current development of such guidelines entails an *ex officio* and an *ex ante* identification of the main normative aspects (basic rules and principles) to take into consideration in the robotic technology development. At risk to fragment the problem and miss commonalities within robotics or other disciplines, major European projects and institutions have conducted research in this direction in the past few years. Although this research has provided a guidance to regulators on how to regulate robot technology ethically, guidelines for the development of particular robot technology – in this case personal care robots – are still missing.

Roboticians may be the more and more aware of the importance of such rules and principles, especially after recent media coverage, inclusion of ethical-legal-societal-

issue track in conferences, and the latest resolution of the European Parliament on civil rules on robotics. Yet, roboticists building a precise technology may be confused about the rules and principles that should be applied to their particular technology. Such confusion even increases when it comes to personal care robots, because of the impassiveness of the major healthcare institutions on developing guidelines, the great variety of the state of the art, the misconception of the current robot capabilities, and the vulnerability of the robot target users.

In an ideal scenario, technology will evolve in a clear manner in terms of form and impact. In such an ideal scenario, threats can be responded to in terms of prevention, and opportunities in terms of facilitation. In practice, however, technology development is characterized by uncertainty, thus making the work for regulators more difficult. The precautionary principle will apply to the regulatory methodology to answer these uncertainties, navigating between under- and overregulation, choosing the proper procedure of impact assessment and regulation.

While autonomous cars have received a lot of attention on both the regulatory and technological side during 2011 and 2017 (see next figure), personal care robot technology in the same interim is somewhere in the middle of technology development and very initial stages of regulation (private regulation, ISO 13482:2014). This thesis takes over from the general juridical discussion revolving the regulation of robots other European projects did, and deepens into the analysis of a concrete type of technology. This thesis is an attempt to offer a comprehensive systematic vision of the impacts of personal care robots overarching both technological and regulatory development.

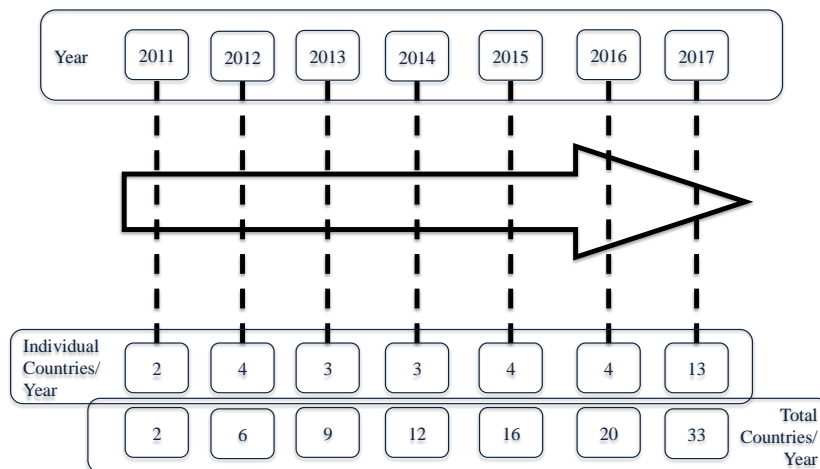

Figure 59 Number of States within the U.S. that have enacted legislation concerning autonomous cars¹¹⁷²

To achieve this goal, the thesis has introduced a technology-tailored impact assessment methodology – Care Robot Impact Assessment, CRIA– an integrative and versatile approach that considers contextual and technological information to draw on legal issues and impacts of concrete robot types, personal care robots. Bottom-up approaches are often criticized because they are associated with the risk of missing some legal issues, fragmenting the problem, and missing commonalities with other technologies. In addition, bottom-up approaches are quite time-consuming. However,

¹¹⁷² The information is extracted from the National Conference State Legislation www.ncsl.org/research/transportation/autonomous-vehicles-self-driving-vehicles-enacted-legislation.aspx

the analysis of concrete cases avoids generalist approaches and offers the possibility to understand how technology works, how general principles could be modeled in concrete cases and which particular solutions should be taken. Moreover, this process is very versatile: if adapted, it could be carried out in the different phases of the robot creation – design, prototype, product – and in different facilities used at that goal – from simulators to testing zone or living lab, respectively.

Although this approach implies interdisciplinary collaboration and time, the protection of the user cannot be at stake because of logistics or time constraints. Moreover, the ending result of such effort conveys a multidisciplinary driven problem-solution flow of information that can serve as a regulatory model for other types of robot when knowledge about the risks is insufficient. CRIA condenses all the legal impacts in one instrument, which helps focus on a particular technology. All this effort could be the starting point for other types of technology that have similar characteristics.

At the moment, CRIA has been conceptually tested in Adele Robots, a Spanish company working on robotic technology, at the CEEO in Tufts University and the LSRO in EPFL research centers and presented in a conference. At the same time, it was also applied to this thesis providing valuable knowledge on the type of technology – including technical characteristics and capabilities – and, especially, identifying legal and ethical aspects connected to that technology; providing at the same time concreteness to the general legal principles identified in previous literature. In order to manage the risk, this work has focused concretely on risk reduction or mitigation. That is why chapters 3 A and B and chapter 4 include a list of issues followed by their possible solutions. All this knowledge supports a vast list of issues/challenges/concerns that could bring clarity within the current legislative turmoil around the topic on how to regulate robot technology – in concrete, how to regulate care robots.

Although representing a huge step towards something that has not been done yet (there are currently no robot impact assessments), impact assessments in the legal domain are currently seen merely as an accountability tool, i.e. a way to show that (in this case) a roboticist is compliant with the legal framework. This means that simply the fulfillment of the accountability requirement (through the impact assessment) does not feed back the legal system per se and, therefore, the law is not (easily) updated with the new advancements in technology – it is currently a separate instrument. This might be more complicated when it is not clear what regulation applies to a specific development – especially if this is under consideration. This thesis, therefore, offers a new vision on the nature of accountability instruments believing that such instruments can be a good source of information on the challenges and issues the newest and recent developments pose to the juridical layer – especially when there is no specific law for certain types of technology. In the future, one may think about the possibility of a mechanism that could extract relevant juridical knowledge from these accountability tools to apply it to the regulatory process, for instance as part of the evidence-based policy development (see future of work section).

2. General considerations after CRIA application

Robert Mesle highlighted time ago the world is a web of interrelated processes of which we are integral parts, so that all of our choices and actions have consequences for the world around us. A roboticist might not have a broad picture of the impact that

his/her creation can have on the world, but might have a disinterested and selfless concern for the wellbeing of others. A lawmaker might have little knowledge on the capabilities of robot technologies, and sometimes may overlook the benefits of them, but the lawmaker's job is to veil for the protection of the legal order, including the rights of the citizens. It is in this altruistic approach that the assumption of collective responsibility of our decisions should flourish. And this involves everyone in general, and in this particular case, lawmakers and roboticists. Education might play an important role in achieving this interdisciplinary mindset.

We also conclude in this thesis that problems cannot be solved with the same thinking that created them. In an era where there are applications that help people get divorced, and robot lawyers help you manage and claim car fines, we cannot think providing the same legal analysis as time ago. Related to the optimism bias – a person has a tendency to believe that s/he is at less risk of experiencing a negative event compared to others – fast developments in technology are impacting many sides of society, including the legal domain. The way the law is delivered will change over time and so it will be the legal response to advancements in technology. This thesis has been one of the first attempts to combine the traditional top-down legal approach and the bottom-up risk-based approach typical from the engineering side to create a unique hybrid model that feeds engineers and legal scholars with the same knowledge.

In this section we compile some information concerning what we learned over the process of this work:

- a) *The individuality of the technology matters: all robots are unique and may need to comply with different requirements, even if they are from the same category.*

In this thesis we conclude that the individuality of the technology – its characteristics and capabilities – matters. Acknowledging the differences between robots within categories is of crucial importance: each robot is unique and may need to comply with different legal requirements. While the European Union has recognized several robot categories on its latest documents – autonomous means of transport, drones, care robots or medical robots – our analysis shows that the state of the art is highly complex and that there are great differences between devices even within the same category, in our case within personal care robots. The EU Parliament only reflects on some types of robot, i.e. for medical robots they only include surgery robots while rehabilitation robotics are out of the description of medical robots. Moreover, robot types are separated from the analysis of other categories/impacts – human repair and enhancement, education and employment, environmental impact, liability – without highlighting the interconnectivity between these and those.

The existence of person carriers, physical rehabilitation robots, cognitive therapeutic robots, robots for education but also other robots like sexual robots, and the possibility that all these robots are going to be mixed and combined as we mentioned in chapter 1, makes us believe that the specific characteristics of the robot will matter in future legal robot compliance. At this regard, clear rules on whether the medical device regulation scope might be extended to some personal care robots, which are not medical devices per se but might present similar risks to those collected by the medical device regulation are of most importance.

- b) *We may interact with robots in different manners.*

Care robots interact with users in many different ways: physically or cognitively. And depending on each case, the interaction can be also very different: physically-symbiotically, physically-passive, cognitively, psychologically, emotionally, socially, etc. Safeguards concerning HRI, therefore, will have to be specified according to the type of HRI that exists in a case-by-case basis. We also identified that there are currently no guidelines for cognitive human-robot interaction as well as there are no guidelines for precise users, e.g. children, elderly or disabled people. Context might play an important role in determining the safeguards to be taken into account, although it might be possible that the inherent characteristics of the robot make it directly fall into one specific category, e.g. medical device in the case of physical assistant robots. Safety is normally conceived as if it involved a particular physical harm to the person involved, in these cases, in the HRI. As argued in chapter 4, the interaction between humans and robots in mobile servant robots is not truly physical – at most indirectly – but cognitive. There is little literature at this regard, and little is known on what are the safeguards to be applied in systems that interact with us in the cognitive layer.

c) Robots challenge general and new legal principles, which will have to be redefined, concreted and reinterpreted in the case of robot technology.

In chapters 3 to 4, we have highlighted the different nature of such impacts in different robot technology. Depending on robot characteristics, the context of use but also its capabilities, not only impacts will be different – even if they fall under the same realm, e.g. privacy – but also they will be more or less important. In case of exoskeletons for instance, physical privacy and data portability may be of greater importance than in mobile servant robots because the portability of such data will come with the physical limitations of the device, which will involve the translation of the gait pattern from one device to another. This is important because the exoskeleton might not include a recommendation system as assistant robots have, but may exert a direct force to the user without asking the user for permission whether s/he wants to go right or left.

Other aspects that might need to be carefully considered are going to be are non-reversible actions and the use of reinforcement learning. For these reasons, and because we have demonstrated that robots can transform into other robots, there should be cross-regulations that can incorporate different requirements for different systems would be the best. The right not to be subject to a decision based solely on automated processing and the right to human intervention concerning data protection will also have to be reconsidered.

Autonomy in task-oriented robots might relate to perfection of the task and human acceptance. Controls over task are already pre-defined and one could think about implementing privacy-enhancing technologies to control that autonomy. Plus, in some cases autonomy may be needed, e.g. in the case of poor signal. Non-mission tasks may challenge safety and liability. Non-mission tasks challenge the predictability of the systems, although machine learning algorithms might help at this regard. However, attention should be made in the case of reinforcement learning and the safety of the user as well as the responsibility gap or the right to be forgotten. If we ever have a distributed responsibility schema for robot technology as the European Parliament suggests, cloud robotics challenges the way robots learn, and challenge the responsibility of the (human) teacher. Protective stop should be carefully addressed because first, each robot is different (so protective stops will be different in each robot); second, protective stop mode can cause other problems – frustration scenarios; and there is no protective stop for others aspects, such as for data transmission.

The theories of extension of personhood should be revised in the light of the distinction social/non-social robots or, even further, depending on the tasks of the robot develop and the level of automation of such. Robots are not animals, corporations or electronic agents, and not all robots are autonomous or possess the characteristics of an agent. Preciseness at this regard is required because the chosen analogy might imply different consequences as Teubner mentioned.

d) A robot risk assessment that incorporates multi-faceted impact-related areas as an ex ante compulsory requirement can bring clarity as regards of impacts

The EU Parliament resolution reads “The future legislative instrument should be based on an in-depth evaluation by the Commission defining whether the strict liability or the risk management approach should be applied”. Our thesis has focused on the impact assessment methodology.

It is unlikely that the legislator is going to come up with a legislation that can embrace all the state of the art unless it starts using artificial intelligence, and the latest technologies to do so (*see future of work section*). Ideating a compliance methodology that could take into account the particularities of the technology and also the existing regulatory space may be a good solution to start gathering information on what are the legislations that apply to each particular case as we explained in chapter 2. As we hypothesized, although analyzing potential legal issues associated with personal care robots in terms of legal principles is too abstract, a risk-based approach using technology-tailored impact assessments adds a necessary level of precision concerning impacts and mitigation.

This impact assessment should be carried out along the process of the creation of a robot: exploration, experimentation and evaluation. Each different stage bring different knowledge to the assessment, and viceversa: in the exploration phase it will be easier to re-design the robot if this has never been a physical prototype. On the contrary, many issues will arise with the actual implementation of the robot in real environments.

e) The knowledge from the robot impact assessment can be used for evidence-based policymaking purposes.

One of the problems of the current state of the art (*see chapter 2*), is that it is not very clear what discussions will actually turn into a policy action. Based on the previous chapters, we can say that clarity the regulatory compliance process for healthcare robots is needed – which could involve the existing regulatory framework – but also that there are aspects not properly addressed by this existing framework. A qualitative analysis can identify certain aspects that would need to change, but only a quantitative analysis – based on that qualitative approach – would actually make regulators rethink certain aspects of the current legal system.

Accountability tools – impact assessments, and in this case CRIA – cannot only help roboticists’ legal compliance, but also can identify concrete gaps and challenges these tools arise, when the roboticists encounter an impediment to carry out the development of the robot. All this knowledge could be used as a source of information on what are the legal aspects linked to a precise technology and what recurrent topics could be part of a future policy or set of guidelines. This could be the same with the Institutional Review Board’s approvals: a repository could be created to identify more easily what has been approved and under what circumstances to speed the process of

other developments or write a set of guidelines for new projects that might want to know what are the aspects to be taken into account.

This way not only qualitative but also quantitative data could be collected to turn the discussion on robots and law into an actual policy action. Quantitative data could support future policies, what is called evidence-based policies much more common in the United Kingdom.

- f) *Need to provide guidelines for personal care robots the capabilities of which may differ from other types of robots, and may include other types of users.*

While there have been some legal action concerning autonomous cars and robot deliveries in the U.S., little legal action has taken place for healthcare robot technology, either in U.S. or Europe. Robot therapies, for instance, continue without being recognized as alternative/complementary therapy in hospitals and lack of specific guidelines as highlighted in our latest work. The only action that has taken place is mainly from private actors – private standards. The IEEE initiative on ethically designed robots or the British standard on the same topic are the only initiatives that seem to incorporate ethical aspects within the design of robot technology. The problem of these standards is that they are for a fixed price, or upon giving your personal details. While the concerns of the latest Eurobarometers were very high on the acceptance of robots in care applications, the HRI research in care applications is increasing – independently whether it is for trend, economical or practical reasons.

The ISO 13482:2014 remarks that future editions of the standard would include information on other types of users. Not providing such information at the same time of the release constitutes a serious problem because it seems that the risks are known, but due to political or economical reasons the industrial standard did not include such aspects. This might not only endanger certain types of users, it might hamper the current innovations that might have to comply with different rules once they release them.

- g) *Potential need to incorporate a protocol prior the use of healthcare robots.*

After the completion of the previous chapters, we realized that current healthcare robots do not include a protocol before user usage. As it happens with Da Vinci the surgery robot, each hospital decides on how many hours of simulator the doctor needs to carry out before operating, and there is no clear available protocol to check the machine works and that the operation can take place without any overlooked risk. This does not happen with other technologies, like airplanes.

With healthcare technology might happen the same, for instance with the use of exoskeletons. It is not very clear whether there should be certificates to be issued for robot driving – exoskeletons or person carrier – nor whether the user should use a simulator before it uses it – similar to the one when a person needs to take the driver's license. There is an agreement from the community that user may need training sessions and that there is an inevitable spiral of adaptation, but it is not clear with what kind of technology this should be further analyzed and with which not.

- h) *Robots should be able to be tested before their usage using simulators, testing zones and living labs*

There has been a lot of discussion on whether there should be or not testing zones for robots. The problem associated with such testing zones may have an economical nature: it may be very expensive to have such variety of zones to test all the state of the art, which we conclude in the thesis that it is very vague. A solution could be the use of simulators. Simulators are a good tool envisage how a prototype should look like. The simulator can simulate countless of scenarios, behaviors and robot modifications with practically no cost.

Although there might be a translation problem between legal principles and computational simulation, the flexibility and integrative nature of simulators may welcome the use of legal principles (e.g. privacy-by-default or ethics-by-design) within the development process (normally in the idea and concept phases) of a robot. Furthermore, the simulator can predict what type of testing zone would be the best to test the robot. After the testing zone, a living lab may provide more realistic information in what are the aspects to take into account within the robot. The European Network of Living Labs could be considered as a network of already existing labs that could welcome this robot technology. Considering such network as a source of empirical data for evidence-based policies concerning robot technology could bring clarity on what should be taken into consideration in the policy.

i) Until creators do not see the value of incorporating legal and ethical aspects into their technology, there will be no great progress at this regard

This is a general conclusion that we arrived after conducting this research. Normally roboticists see legal compliance as a burden, possibly because they are not experts on the topic, but also because there may be no clarity on what exactly they need to do to incorporate such aspects into their technology. In fact, many times roboticists already take time to develop their technology that they do not have time to think about these aspects. It is true however that many roboticists see the importance of addressing all these topics. Why then there is no progress at such regard?

A tentative response would be that there has been no business model around the incorporation of ELS aspects into robotic technology. And this is reflected also in the European research projects, where the compliance with the legal system is a requirement that relates to how the research is conducted and how the rights of the persons involved in the research are ensured, but incorporating such aspects into the design does not give any value to get the funds. To us, it seems that this is similar to the organic products market. Product legislation is already very restrictive in many senses, but it has even stricter criteria for bio-products. At some point in time, some producers believed in following stricter rules as an added value to their product: to have more environmental-friendly products, higher quality products, etc. Today, this market grows every year according to the International Organization of Organic Agriculture Movements (IFOAM). There might come a time when there are some robot legal and ethical guidelines (similar to the British Standard or IEEE initiative) and producers may want to follow them or not, depending on whether they want to have such added value or not.

3. Specific considerations after CRIA application

Person carriers

Our hypothesis was that current carriers would not require a complex regulatory framework like other more complex robots (e.g. social assistive robots) because the involved HRI is not as high as exoskeletons for instance. Person carriers are also task-oriented. Their regulatory framework was envisioned to be mainly based on safety, user protection (health, consumer protection, environmental regulation, and prevention from patients harming themselves) and liability, which are necessary for all robots to have market value as products. On the contrary, the care robot impact assessment that includes technical and contextual knowledge shows that robots within this category may be subjected to transformations, may be used in both indoor or outdoor scenarios. They were the first robot analyzed and thus the first assessment that showed the importance of the case-by-case analysis and the significance of correct categories (for safety and consumer protection issues).

Recent developments on the medical device and autonomous car regulation may give clarity on what is the existing regulation these devices will have to follow. The complexity of the technology, however, may hamper such affirmation. There might be carriers that are similar to wheelchairs, for instance wheeled passenger carriers; others similar to cars, such as outdoor multiple-passenger carriers. These type of robots are very versatile, because they can be used indoor, outdoor, and they can take many different forms. There happen to exist transforming categories within person carriers too: an existing category turns into another category, either within personal care category (person carrier to mobile servant) or with other categories (bed into person carrier). Safeguards at this regard may involve not only multiple-category safeguards within the state and the transition time, but also acknowledge that into the certification. In any case, clarity will be needed in the light of these developments because these robots may present differences between these examples.

The assessment of person carriers also tell that dignity and ethical aspects will be very important even if they are task-oriented and do not interact with users on a cognitive level. These dignity questions may turn into concrete scenarios – a person carrier that stops working in the middle of a park can provoke a difficult scenario that was not envisaged by non-robotic carriers (because the protective stop mode may impede its movement) – and the ethical side may entail questions concerning the autonomous behavior of the carrier and the intentions of the user.

Physical assistants

The assessment of physical assistant robots highlighted how important determining the interaction between the human and the robot is. Determining that an interaction is “physical” might not suffice to explain the complexity of certain robotic devices, and may be crucial on the contrary to know what aspects should incorporate the legislation. In this case, this type of robots can be fastened to the body of the person. This entails a complete paradigm shift in safety that may not only involve the device or the environment, but especially the user – i.e. user-centered design. More research is needed to understand what are the minimum requirements that these devices should offer so that scenarios where more expensive devices are safer are eliminated.

The assessment on exoskeletons reveals that there might be non-reversible actions when humans use robots – e.g. a fall. The assessment acknowledges that, although there are many efforts towards preventing accidents, current safety measures fall short in coping with accident occurrence. Seeing that these accidents may entail non-reversible actions, future physical assistant legislation should incorporate specific measures on what to do in the light of an accident, for instance including as a *condition*

sine qua non requirements push recovery algorithms and airbags. Of note, because exoskeletons have medical and non-medical device version, this legislation may be the medical device legislation. This legislation may bring more clarity to the prospective liability, also acknowledge in this assessment.

The physical assistant robot assessment also reveals that cognitive aspects revolving robots are of crucial importance. In the case of exoskeletons, the assessment highlights the importance of the fear of falling of the user, which is acknowledge but currently understudied. Another aspects is cosmesis, which may be very important for dignity and justice matters in robot technology. Current exoskeletons are bulky and heavy, impeding in most of the cases a normal human-human interaction. The latest research on soft materials shows a progression in this regard, which may lead to think that the more and more these devices will be integrated into our daily lives, by becoming truly pieces of clothes. This may have its own importance also concerning data protection, as the awareness of the collection of data will have to be secured.

Upcoming training centers, independently if these centers work in a bring-your-own-device basis or if they provide the robots to the users, reveal that robots will facilitate the more and more the personalization of care, which will challenge data protection and ethical principles. Data protection because it will have to be ensured that this data is available to the users, especially in the case they change device (ex data portability right) but also on the balance between personalization and dependence.

Mobile servants

The mobile servant robot assessment confirms the importance on acknowledging the different existing HRI, especially for regulatory matters: there might be robots with whom we will interact not only physically but also cognitively. This assessment shows, however, that there are currently no guidelines or research on what are the safeguards to be applied to those HRIs that are not physical. Some authors identified the importance of incorporating “trustworthiness” as a safety requirement, which may include social awareness navigation. This will get more importance when robots will be used in therapeutic contexts, independently of whether they are considered toy robots or medical devices.

The assessment shows that current techniques on improving safety through machine learning algorithms may have to be redefined in the case of robots that interact closely with humans. It has been acknowledged the fact that reinforcement learning might be very dangerous in certain cases and that it should be reserved for testing zones. In any case, the fact that the robot will learn over time, this may entail the new regulations to include life-cycle protection measures. This will be even of greater importance if robots will share information and learn through cloud platforms, which will entail multiple jurisdiction compliance at all levels from data protection to safety requirements. Concerning data protection, mobile servant robots might commence to process emotional data from the user so that they can be empathic with personal circumstances of the user. This not only may challenge data protection but also will arise many ethical questions, such as until what extend we will be able to hide who we truly are to machines.

Another finding of the assessment is that these robots perform tasks for the user, and do not help the user perform a task. The autonomy of the robot on deciding how to perform such task may not only challenge the autonomy of the user but also the current liability framework.

4. Future Work

As we mentioned, at the early stages of technology, developing hard law regulation may not make sense as impacts and concerns may be unclear and the risk of overregulation may be very high. On the contrary, in a mature stage of technology development - when impacts and risks are clearer – merely applying guidelines may lead to under-regulation. The exponential growth of such technologies will nonetheless challenge the applicability of such guidelines, which may be outdated for new developments.

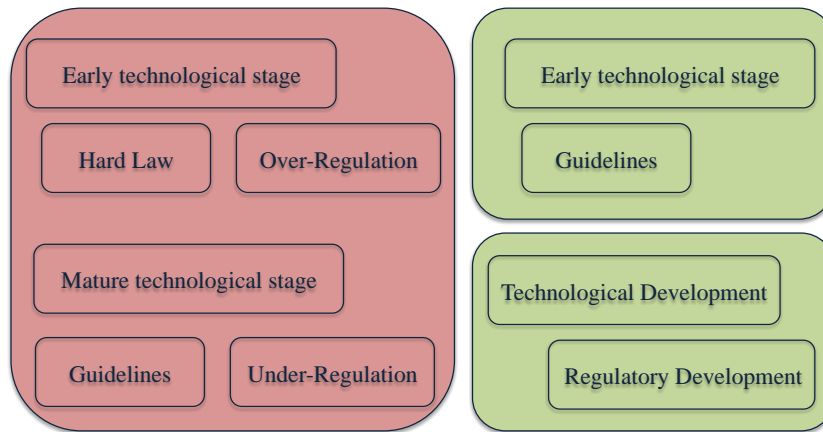

Figure 60 Technological and regulatory development adequacy

This might be the case of the robotic wheelchair that incorporated a robotic arm to help users move around their dwelling (to carry out tasks as opening doors or moving obstacles) and perform activities of the daily living (ADL) such as opening the fridge, grabbing a glass of water from the Human Engineering Research Laboratory (HERL) Center at the University of Pittsburgh. Some researchers at Carnegie Mellon University, also in Pittsburgh, are working on a feeding function for an arm incorporated to a similar robotic wheelchair¹¹⁷³.

¹¹⁷³ The project is called Assistive Dexterous Arm (ADA), a wheelchair-mounted robotic arm where they are being developing the feeding function, including the arch movement into the robotic arm. The main researcher under this project is Laura Herlant: www.ri.cmu.edu/person.html?person_id=3157.



Figure 61 Wheelchair with Robotic Arm from the Human Engineering Research Laboratory (HERL) Center at the University of Pittsburgh¹¹⁷⁴

Future work in this field may go in this direction, in trying to make the gap between technology and regulatory development smaller. This may imply 1) giving technical content to juridical principles, 2) using new technologies for accountability purposes, 3) using these technologies to inform evidence-based policies, and 4) allowing learning and evidence utilization by the regulatory system:

1) *Give ethical content to juridical principles.* The more technology will be complex and diverse, the more the general legal principles will have to be concretized. The juridical system cannot ask for strict legal compliance – and imposing severe consequences for violations, including criminal charges in some cases (as with the new GDPR) – if there is no effort to explain how roboticists may proceed. The typical example is the *privacy-by-design*, which may include technical and organizational measures, but that there is no clarity on what does it cover and what are the concrete actions that one can take to comply with it. Recent private initiatives such as the BS 8611:2016 on ethical robot design or the yet not published IEEE ethically aligned design could give the required technical dimension to these principles, although the discourse on the nature of standards will be questioned again. The involvement of public authorities in the development of such standards could solve this problem. In Europe this could be done through the new public-private partnership (PPP) in Robotics, which was founded in 2012 between the European Commission and the European Industry and Academia and it is called SPARC. This PPP includes an ELS and a Standard section that relate to robotic technologies, and could be used at this regard.

2) *Using new technologies for accountabilities purposes.* Part of the law-and-robot community believes that there is no need to update our legislative framework due to robot technology. However, most of the times it is difficult to know what regulations apply to a certain robot as we have seen in this thesis. Applying new technologies to

¹¹⁷⁴ Own picture, with permission from HERL.

help that process, to help matching robot characteristics and current relevant pieces of legislation, could help roboticists know what aspects they should follow. In 2016, the Consumer Product Safety Commission (CPSC) launched “Regulatory Robot” (RR), a portal that tries to facilitate the identification of the American federal product safety requirements for those who want to manufacture a product (for children or for other consumers)¹¹⁷⁵.

Safer Products Start Here!



Welcome to CPSC's Regulatory Robot!

Figure 62 Screenshot of the Regulatory Robot of the Consumer Product Safety Commission

The software is intended to guide a manufacturer through the current legislation. The system is the very first version of what it could be a personalized (yet no dynamic) regulation. This is because one of the innovative aspects of RR is to recognize the individuality and specificity of each product stating that “as most products are unique, each product may need to comply with different requirements so you'll need to run the Robot one time for each product”. The system includes some simple questions about the product to provide manufacturers with a basic guidance for the design and the manufacturing process. After all the questions are answers, a personalized regulatory model for the product is given to the user.

At its current stage, and although the CPSC says “we hope that the Regulatory Robot is the beginning of your journey to manufacture products that are safe and compliant for American consumers”, the system does not really help roboticists, even if they are creating products according to EPSRC1176. In any case, matching factors with current pieces of legislation might be a way to easy and speed the compliance process of roboticists (and in fact, to any one creating a new product).

In the case of the robotic wheelchair, this (future) autonomous system could provide a personalized regulatory framework that could help identify the necessary safety requirements according to the characteristics of the device: safeguards for the arm, safeguards for the wheelchair, safeguards for the feeding function.

3) *Using these technologies for evidence-based policies.* What we have seen in this thesis is that although regulatory and technological developments are not totally miscommunicated, there are obvious mismatches on such developments. Future research will try to speed this communication process between both developments.

In this not yet invented accountability tool for robot technology, aspects like cognitive safeguards or transforming/complex categories may not be found – because they are not yet part of the regulatory system. The system, therefore, should be done in a way that could identify those gaps through an interactive portal/form, maybe incorporating a “have not found an answer” box, or through a fill-in box. These

¹¹⁷⁵ See: www.cpsc.gov/en/Business--Manufacturing/Regulatory-Robot/Safer-Products-Start-Here/

¹¹⁷⁶ See www.epsrc.ac.uk/research/ourportfolio/themes/engineering/activities/principlesofrobotics/.

gaps/issues/concerns could be then be sent in a report format to the competent authority (probably the future European Robot Agency advocated by the latest European Parliament's resolution¹¹⁷⁷ or directly the current Robotics & Artificial Intelligence, DG Connect of the European Commission¹¹⁷⁸ for European matters, but also to national competent authorities) so that it can intervene – similar as other agencies are doing for data protection: Article 29 Working Party or European Data Protection Supervisor. The competent authority should intervene developing guidelines, writing protocols, modifying or creating legislation *ex novo* following all the juridical guarantees or allowing deregulatory environments (living labs). This idea is similar to what the initiative “if you smell something, say something” does. This is an app from the CREATE Lab of Carnegie Mellon University that submits a smell report (a report on air quality) to the Allegheny County Health Department (ACHD) in Pittsburgh in a very easy way. ACHD not only has a record of all the complaints, it has the obligation to respond individually to each user.

The system could learn over time to perfect its accuracy and incorporate all the new decisions and recommendations of the competent authority. This promotes safer technology because it allows continuous communication between the creator of the technology and the regulator: while roboticists have to run a legal compliance – legal screening – tool at different stages of its production so the product is compliant with existing technology, the regulators can frame appropriately the legal discussion revolving robotic technology, and are forced to give a response. This eventually gives the opportunity to regulators to provide much more meaningful guidelines for future safer developments, and eases the entrance of roboticists' products into the market.

4) *Allowing learning and evidence utilization by the regulatory system.* Of the entire policy appraisal research that has been done so far – including literature review of the design, performance and politics of the appraisal – future work may strongly focus on the learning and evidence utilization side of it¹¹⁷⁹. This part of the literature searches for evidence that the assessment has led to policy change via processes of learning from either an instrumental approach – basically when the knowledge informs directly concrete decisions – or from a conceptual one – a more soft-power approach, meaning that new information, ideas, and perspectives influence policymakers and, thus, little by little the policy system¹¹⁸⁰. In this case, the robot assessment could lead directly to a policy change if there was such mechanism.

For us, the policy cycle is truly closed when it starts – or allows to be started – again upon new challenges/technologies, thus, under the idea of a continuum. That is why, after having fed back the regulation, *ex-post* legislative evaluations could help improve the system over time as they are critical evidence-based judgments of the extent to which an intervention has been effective and efficient, both regarding what happened but also why and how¹¹⁸¹.

¹¹⁷⁷ 2015/2103(INL) (February, 2017). European Parliament Report on Civil Law Rules on Robotics.

¹¹⁷⁸ See ec.europa.eu/digital-single-market/en/who-we-are-dg-connect.

¹¹⁷⁹ Adelle, C., et al. (2012). Proceeding in parallel or drifting apart? A systematic review of policy appraisal research and practices. *Environment and Planning C: Government and Policy*, 30(3), 401-415.

¹¹⁸⁰ Ibidem. See also the original reference made by Adelle Hertin, J., et al. (2009). Rationalising the policy mess? *Ex ante* policy assessment and the utilisation of knowledge in the policy process. *Environment and Planning A*, 41(5), 1185-1200.

¹¹⁸¹ Commission Staff Working Document (2015) Better Regulation Guidelines. Available at: ec.europa.eu/smart-regulation/guidelines/docs/swd_br_guidelines_en.pdf. See also Communication from the EC to the European Parliament, Council, EESC, and COREPER (2013) Strengthening the foundations of Smart Regulation – improving evaluation. Available at: ec.europa.eu/smart-regulation/docs/com_2013_686_en.pdf

Until all this happens, promoting the ELS culture among roboticists would be the most effective way to see a change in the current legislative turmoil. Educational initiatives on the importance of legal and ethical aspects concerning technology may help spreading awareness. These may include summer schools¹¹⁸², courses in technical faculties, ELS tracks in conferences, etc.

As a final statement, we would like to say that the delicateness of the discussed problems and the huge impact these technologies can have in the general population creates the duty and responsibility for those in charge of developing guidelines to thoroughly and carefully study all these cases, create awareness of the importance of it and do their best to promote meaningful and applicable guidelines to help those creating technology that can positively change people's life.

¹¹⁸² For instance, this summer school organized by the University of Pisa: www.europeregulatesrobotics-summer-school.santannapisa.it

Bibliography

1. Literature Review

A

- Abadi, M., et al. (2016). Deep Learning with Differential Privacy. Open Access
- Abdi, E., Burdet, E., Bouri, M., Himidan, S., & Bleuler, H. (2016). In a demanding task, three-handed manipulation is preferred to two-handed manipulation. *Scientific reports*, 6.
- Abbott, K.W. and Snidal, D. (2000). Hard and Soft Law in International Governance. *International Organization*, 54, pp 421-456
- Acquisti, A., John, L. K., & Loewenstein, G. (2013). What is privacy worth?. *The Journal of Legal Studies*, 42(2), 249-274.
- Albo-Canals, J. (2015) Toy Robot versus Medical Device. Newfriends Conference on Social Robots in Therapy and Education. Almere, The Netherlands
- Allen, C., Smit, I., & Wallach, W. (2005). Artificial morality: Top-down, bottom-up, and hybrid approaches. *Ethics and Information Technology*, 7(3), pp. 149-155.
- Alnemr, R., Cayirci, E., Dalla Corte, L., Garaga, A., Leenes, R., Mhungu, R., et al. (2015, October). A data protection impact assessment methodology for cloud. In *Annual Privacy Forum*, Springer International Publishing, pp. 60-92.
- Amodei, D., Olah, C., Steinhardt, J., Christiano, P., Schulman, J., & Mané, D. (2016). Concrete problems in AI safety. arXiv preprint arXiv:1606.06565.
- Andrade, N. N. G. (2010). The Right to Privacy and the Right to Identity in the Age of Ubiquitous Computing: Friends or Foes? A Proposal. *Personal Data Privacy and Protection in a Surveillance Era: Technologies and Practices: Technologies and Practices*, 19.
- Anekar, A., Bagade, N., Jogdand, A., & Tayade, M. (2016). Automatic Traffic Signal Management System. *Imperial Journal of Interdisciplinary Research*, 2(6)
- Arai, T., Kato, R., & Fujita, M. (2010). Assessment of operator stress induced by robot collaboration in assembly. *CIRP Annals-Manufacturing Technology*, 59(1), 5-8.
- Arneson, R. (1989) Equality and Equal Opportunity for Welfare. *Philosophical Studies* 56, pp. 79-95
- Asaro, P. M. (2007). Robots and responsibility from a legal perspective. *Proceedings of the IEEE*, 20-24
- Atzori, M. (2014) Electromyography Data for Non-Invasive Naturally-Controlled Robotic Hand Prostheses. *Scientific Data* 53.

B

- Baddoura, R., & Venture, G. (2015). This Robot is Sociable: Close-up on the Gestures and Measured Motion of a Human Responding to a Proactive Robot. *IJSR*, 7(4), 489-496.
- Barattini, Paolo, Claire Morand, and Neil M. Robertson. (2012) A proposed gesture set for the control of industrial collaborative robots. *IEEE RO-MAN: The 21st IEEE International Symposium on Robot and Human Interactive Communication*. IEEE
- Barco A, et al. (2014) Engagement based on a customization of an iPod-LEGO robot for a long- term interaction for an educational purpose. *ACM/IEEE HRI*, pp 124-125
- Barco, A., et al. (2014). A drop-out rate in a long-term cognitive rehabilitation program through robotics aimed at children with TBI. *23rd IEEE International Symposium on Robot and Human Interactive Communication, 2014 RO-MAN*, pp. 186-192.

- Bartneck, C. et al. (2009) Measurement Instruments for the Anthropomorphism, Animacy, Likeability, Perceived Intelligence, and Perceived Safety of Robots. *International Journal of Social Robots* 1: pp. 71–81
- Bartneck C, Forlizzi J (2004) A design-centred framework for social human-robot interaction. In: *IEEE International workshop on robot and human interactive communication.*, pp 591–594
- Bartneck, C., Kulić, D., Croft, E., & Zoghbi, S. (2009). Measurement instruments for the anthropomorphism, animacy, likeability, perceived intelligence, and perceived safety of robots. *International journal of social robotics*, 1(1), 71-81
- Bartneck, C., Suzuki, T., Kanda, T., & Nomura, T. (2007). The influence of people's culture and prior experiences with Aibo on their attitude towards robots. *Ai & Society*, 21(1-2), 217-230
- Baud. R. et al. (2016) HiBSO Hip Exoskeleton: Toward a Wearable and Autonomous Design. *International Workshop on Medical and Service Robotics (MESROB) 2016 Workshop Proceedings.*
- Becker, M. et al (2013) *Cyberpsychology, Behavior, and Social Networking*, 16(2) pp. 132-135.
- Bekey, G. (2012). *Current trends in robotics: technology and ethics. Robot ethics: the ethical and social implications of robotics.* MIT Press, Cambridge, pp. 17-34
- Bemelmans, R., Gelderblom, G. J., Jonker, P., & De Witte, L. (2012). Socially assistive robots in elderly care: A systematic review into effects and effectiveness. *Journal of the American Medical Directors Association*, 13(2), 114-120.
- Benitez-Sandoval, E. et al. (2015) Reciprocity in Human-Robot Interaction: A Quantitative Approach Through the Prisoner's Dilemma and the Ultimatum Game. *Int J of Soc Robotics* 1:15
- Benyon and O. Mival (2010) *From Human-Computer Interaction to Human-Companion Relationships*, IITM'10, Allahabad, UP, India, ACM
- Bertolini, A. and Palmerini, E. (2014) *Regulating Robotics: A Challenge for Europe.* European Union.
- Bertolini, A., et al. (2016). *On Robots and Insurance.* *International Journal of Social Robotics*, 1-11
- Bian, N., Gamulescu, C., & Haas, T. (2010). Fusion of vehicle and environmental sensing. *ATZ worldwide*, 112(9), 18-22.
- Birtchnell, T., & Urry, J. (2016). *A New Industrial Future?: 3D Printing and the Reconfiguring of Production, Distribution, and Consumption.* Routledge.
- Blanke, O. et al. (2014). Neurological and robot-controlled induction of an apparition. *Current Biology*, 24(22), 2681-2686
- Bonaccorsi, M., Fiorini, L., Cavallo, F., Saffiotti, A., & Dario, P. (2016). A Cloud Robotics Solution to Improve Social Assistive Robots for Active and Healthy Aging. *International Journal of Social Robotics*, 1-16
- Borenstein, J. and Arkin, R. (2016). Robotic Nudges: The Ethics of Engineering a More Socially Just Human Being. *Science and engineering ethics*, 22(1), 31-46
- Breazeal, C. (2002). *Designing Sociable Robots.* Cambridge, MA, USA . MIT Press
- Breazeal, C. (2003). Toward sociable robots. *Robotics and autonomous systems*, 42(3), 167-175
- Breazeal, C., and Aryananda, L. (2002). Recognition of affective communicative intent in robot-directed speech. *Autonomous robots*, 12(1), 83-104
- Breazeal, C., & Scassellati, B. (1999). How to build robots that make friends and influence people. *International Conference on Intelligent Robots and Systems, IROS, 1999 Proceedings. Vol. 2*, pp. 858-863

- Briggs, G., & Scheutz, M. (2015). Sorry, I can't do that": Developing mechanisms to appropriately reject directives in human-robot interactions. In 2015 AAAI Fall Symposium Series
- Bostrom, N. (2014) *Superintelligence: paths, dangers, strategies*. Oxford University Press. In a similar way, see Dewey, D. (2011) Learning what to value. In *Artificial General Intelligence*. Springer. 309–314.
- Broadbent, E. et al. (2013) Robots with Display Screens: A Robot with a More Humanlike Face Display Is Perceived To Have More Mind and a Better Personality. *PloS one*, 8(8)
- Broadbent, E., Stafford, R., & MacDonald, B. (2009). Acceptance of healthcare robots for the older population: review and future directions. *International Journal of Social Robotics*, 1(4), 319-330
- Brscić, D., Kidokoro, H., Suehiro, Y., & Kanda, T. (2015, March). Escaping from Children's Abuse of Social Robots. In *Proceedings of the Tenth Annual ACM/IEEE International Conference on Human-Robot Interaction*, pp. 59-66.
- Bryant Walker Smith, Teil V (2015) Regulation and the Risk of Inaction, in: Maurer et al. (eds.), *Autonomes Fahren*, pp 593-609.
- Bucks, R. S., Ashworth, D. L., Wilcock, G. K., & Siegfried, K. (1996). Assessment of activities of daily living in dementia: development of the Bristol Activities of Daily Living Scale. *Age and ageing*, 25(2), 113-120.
- Bryson, J. J. (2010). Robots should be slaves. *Close Engagements with Artificial Companions: Key social, psychological, ethical and design issues*, 63-74.

C

- Caffrey, C.M. et al. (2008) Swallowable-Capsule Technology. *IEEE CS, Pervasive Computing*, pp. 23-29
- Calder CJ (1990) Fatal Wheelchair-Related Accidents in the United States. *Am J Phys Med Rehabil* 69:4, pp.184-190
- Calo, R. (2012) *Robots and Privacy*. In: Lin, P. et al. (2012) *Robot Ethics: The Ethics and Social Implications of Robotics*. Cambridge, MA: MIT Press
- Calo, R. (2015) *Robotics and the Lessons of Cyberlaw*. 103 *California Law Review*
- Calo, R. (2016). *Robots in American Law*. University of Washington School of Law Research Paper, SSRN.
- Čapek, K. (2004). *RUR (Rossum's universal robots)*. Penguin
- Campbell, T., Williams, C., Ivanova, O., & Garrett, B. (2011). Could 3D printing change the world. *Technologies, Potential, and Implications of Additive Manufacturing*, Atlantic Council, Washington, DC.
- Casey, D., & Scott, C. (2011). The crystallization of regulatory norms. *JLS*, 38(1), 76-95
- Cerqui, D.; Kai O. (2001) Human Beings and Robots: Towards a Symbiosis? A 2000 People Survey. In: Carrasquero, J. and al. (eds) (2001) *Post-Conference Proceedings Politics and Information Systems: Technologies and Applications*. PISTA 03, pp. 408-413
- Chander, A. (2016). *The Racist Algorithm?*. *Michigan Law Review*, 2017
- Chapin, F. S. (1939) Definition of Definitions of Concepts. In: *Social Forces*, Vol. 18, No. 2, pp. 153-160.
- Charles, K. K., & Sevak, P. (2005). Can family caregiving substitute for nursing home care?. *Journal of health economics*, 24(6), 1174-1190.
- Chen, Y., et al. (2009). Large-scale behavioral targeting. In *Proceedings of the 15th ACM SIGKDD international conference on Knowledge discovery and data mining* (pp. 209-218). ACM

- Chopra, S. and White, L. (2004) Artificial Agents - Personhood in Law and Philosophy, in Proceedings of the 16th European Conference on Artificial Intelligence, pp. 635-9.
- Chopra, S. and White L.F. (2011) A Legal Theory for Autonomous Artificial Agents. University of Michigan Press.
- Cicco, M. di et al. (2004) Comparison of Control Strategies for an EMG Controlled Orthotic Exoskeleton for the Hand. IEEE International Conference on Robotics and Automation, pp. 1622-1627.
- Clark, R. A. et al. (2007) Telemonitoring or structured telephone support programmes for patients with chronic heart failure: Systematic review and meta-analysis. British Medical Journal, 333, p. 942.
- Coeckelbergh, M. (2010). Moral appearances: emotions, robots, and human morality. Ethics and Information Technology, 12(3), pp. 235-241
- Coeckelbergh, M. (2015) The tragedy of the master: automation, vulnerability, and distance. Ethics of Information Technology, (2015), 17:219-229
- Coetzee L and Olivrin G (2012) Inclusion Through the Internet of Things. INTECH Open Access Publisher, pp. 51-79
- Cohen, G. A. (1989) On the Currency of Egalitarian Justice. Ethics 99, pp. 906-44
- Coleman, J. S. (1994) Foundations of Social Theory. Harvard University Press. p. 66
- Collins, E. C. et al. (2015) Saying it with Light: A Pilot Study of Affective Communication Using the MIRO Robot. In Wilson, S.P. et al. (2015) Living Machines, LNAI 9222, pp. 243-255.
- Colton, S., & Wiggins, G. A. (2012). Computational creativity: The final frontier?. In ECAI Vol. 12, pp. 21-26.
- Cummings, M. L. (2004). Creating moral buffers in weapon control interface design. Technology and Society Magazine, IEEE, 23(3), pp. 28–33
- Cummings, M. L. (2006). Automation and accountability in decision support system interface design. Journal of Technology Studies, 32(1), pp. 23–31.

D

- Dang, T. and Tapus A, (2015) Stress Game: The Role of Motivational Robotic Assistance in Reducing User's Task Stress, Int J of Soc Robotics 7:227–240
- Dario, P. et al. (2014) Ambient Assisted Living Roadmap. AALIANCE2 Project Deliverable 2.7
- Darling, K. (2012). Extending legal rights to social robots. In We Robot Conference, University of Miami, April.
- Darling, K. (2016) Extending Legal Protection to Social Robots: The Effects of Anthropomorphism, Empathy and Violent Behavior towards Robotic Objects. In: Calo, R. et al. (2016) Robot Law, Edward Elgar Publishing.
- Datteri, E. (2013) Predicting the Long-Term Effects of Human-Robot Interaction: A Reflection on Responsibility in Medical Robotics. Science Engineering Ethics 19, pp. 139-160.
- Dautenhahn, K., & Billard, A. (1999, April). Bringing up robots or—the psychology of socially intelligent robots: From theory to implementation. In Proceedings of the third annual conference on Autonomous Agents, pp. 366-367.
- Dautenhahn, K. (2007). Socially intelligent robots: dimensions of human–robot interaction. Philosophical Transactions of the Royal Society B: Biological Sciences, 362(1480), 679-704.
- Dautenhahn, K. (2004). Robots We Like to Live with?! A Developmental Perspective on a Personalized, Life-long Robot Companion. In Robot and Human Interactive

- Communication, 2004. ROMAN. 13th IEEE International Workshop, IEEE, pp. 17-22
- Dinwiddie, K. (2015). *Basic Robotics*. Nelson Education p. 117
- Dogramadzi, S. et al (2014) Environmental Hazard Analysis - a Variant of Preliminary Hazard Analysis for Autonomous Mobile Robots. *J Intell Robot Syst* 76:73–117.
- Duffy, B. R. (2000). *The Social Robot*. PhD Thesis, Department of Computer Science, Univ. College Dublin
- Duffy, B. R. (2003). Anthropomorphism and the social robot. *Robotics and autonomous systems*, 42(3), 177-190
- Duvinage, M. et al. (2011) Control of a Lower Limb Active Prosthesis with Eye Movement Sequences. *IEEE Symposium on Computational Intelligence, Cognitive Algorithms, Mind and Brain (CCMB)*
- Dworkin, R. (1981) What is Equality? Part 2: Equality of Resources. *Philosophy and Public Affairs* 10, pp. 283-345
- Dworkin, R. (2000) *Sovereign Virtue: The Theory and Practice of Equality*. Cambridge: Harvard University Press
- Dworkin, R. (2011). *Justice for hedgehogs*. Harvard University Press

E

- Edwards, L., & Harbinja, E. (2013). Protecting post-mortem privacy: reconsidering the privacy interests of the deceased in a digital world
- Eley, T. C., Stirling, L., Ehlers, A., Gregory, A. M., & Clark, D. M. (2004). Heart-beat perception, panic/somatic symptoms and anxiety sensitivity in children. *Behaviour research and therapy*, 42(4), 439-448.
- Endo, G. et al. (2015) Mobile Follower Robot as an Assistive Device for Home Oxygen Therapy – Evaluation of Tether Control Algorithms. *ROBOMECH Journal*, 2:6
- Erevelles, S. et al. (2016) Big Data Consumer Analytics and the Transformation of Marketing. *Journal of Business Research* 69, pp. 897-904

F

- Faria B M et al. (2014) Adapted Control Methods for Cerebral Palsy Users of an Intelligent Wheelchair. *Journal of Intelligent Robot Systems* 77:299-312.
- Feil-Seifer, D., & Matarić, M. J. (2011). Socially assistive robotics. *IEEE Robotics & Automation Magazine*, 18(1), 24-31
- Ferri, G., et al. (2011, May). DustCart, an autonomous robot for door-to-door garbage collection: From DustBot project to the experimentation in the small town of Peccioli. *IEEE International Conference on Robotics and Automation (ICRA)*, 2011, pp. 655-660
- Fetzer, J. H., Schlesinger, G. N. and Shatz, D. (1991) *Definitions and Definability Philosophical Perspectives*. Synthese Library Studies in Epistemology, Logic, Methodology, and Philosophy of Science, Vol. 216
- Fink, J. et al. (2013). Motivating Children to Tidy up their Toys with a Robotic Box. Presentation and Poster at the 8th ACM/IEEE International Conference on Human-Robot Interaction (HRI) 2013, Pioneers Workshop, Tokyo, Japan
- Fisk, A.D.; Rogers, W. A. (2002) *Psychology and Aging: Enhancing the Lives of an Aging Population*. *Current Directions in Psychological Science*, vol. 11, num. 3. American Psychological Society.

- Floridi, L. (2014). *The fourth revolution: How the infosphere is reshaping human reality*. Oxford University Press
- Floridi, L. and Sanders, J. W. (2004) On the Morality of Artificial Agents. *Minds and Machine*, num. 14, pp. 349-379. Kluwer Academic Publishers
- Fong, T. et al. (2003) A Survey of Socially Interactive Robots. *Robotics and Autonomous Systems*, 42, p. 145
- Fosch-Villaronga, E. (2015) Creation of a Care Robot Impact Assessment. *WASET, International Science Journal of Social, Behavioral, Educational, Economic and Management Engineering*, 9(6), pp. 1817 – 1821.
- Fosch-Villaronga, E. (2016). ISO 13482:2014 and Its Confusing Categories. *Building a Bridge Between Law and Robotics*. In Wenger, et al. (Eds.) *New Trends in Medical and Service Robots*, Vol. 39, Series Mechanisms and Machine Science, Springer, pp. 31-44.
- Fosch-Villaronga, E., and Albo-Canals, J. (2015). Boundaries in Play-based Cloud-companion-mediated Robotic Therapies: From Deception to Privacy Concerns. In *Conference Proceedings New Friends 2015*, Vol. 164, No. 6, pp. 597-600
- Fosch-Villaronga, E. and Heldeweg, M.A. (2017) HRI and the Future of Law. *HRI '17 Companion*, March 06-09, 2017, Vienna, Austria
- Fosch-Villaronga, E. and Roig, A. (2017). European regulatory framework for person carrier robots. *Computer Law & Security Review*.
- Frennert, S. and Östlund B. (2014) Review: Seven Matters of Concern of Social Robots and Older People, *Int J of Soc Robotics* 6:299–310
- Fryman, Jeff, and Björn Matthias. (2012) Safety of industrial robots: From conventional to collaborative applications." *Robotics; Proceedings of ROBOTIK 2012; 7th German Conference on VDE*.

G

- Galloway, J.C.; Ryu J.; and Agrawal S.K. (2008) Babies Driving Robots: Self-Generated Mobility in Very Young Infants. *Intel Serv Robotics*, 1, pp. 123-134
- Gamerman, G. E. (1992). Intended use and medical devices: distinguishing nonmedical devices from medical devices under 21 USC 321 (h). *Geo. Wash. L. Rev.*, 61, 806.
- Gao, C., et al. (2008). Autonomous docking of a smart wheelchair for the automated transport and retrieval system (ATRS). *Journal of Field Robotics*, 25(4), pp. 203.
- Gao C et al (2010) Towards Autonomous Wheelchair System in Urban Environments. In: Howard A et al (2010) *Field and Service Robotics 7, STAR* 62, pp. 13-23.
- George, R. T. (2008). *The ethics of information technology and business*. John Wiley & Sons
- Glantz, A. (2009). *The war comes home: Washington's battle against America's veterans*. Univ of California Press.
- Goffer, A. (2014). Enhanced safety of gait in powered exoskeletons. In *Dynamic walking conference abstract-available online*. Argo Medical Technologies, Firewalk.
- Graaf, M. M. (2016). An Ethical Evaluation of Human–Robot Relationships. *International Journal of Social Robotics*, 1-10
- Graaf, M. M. A., Allouch, S. B., & van Dijk, J. A. G. M. (2015). What makes robots social?: A user’s perspective on characteristics for social human-robot interaction. In *International Conference on Social Robotics*, Springer International Publishing, pp. 184-193.
- Graaf, M and Ben, S. (2016) The Influence of Prior Expectations of a Robot’s Lifelikeness on Users’ Intentions to Treat a Zoomorphic Robot as a Companion,” *International Journal of Social Robotics*

Granata, C., Pino, M., Legouverneur, G., Vidal, J. S., Bidaud, P., & Rigaud, A. S. (2013). Robot services for elderly with cognitive impairment: testing usability of graphical user interfaces. *Technology and Health Care*, 21(3), 217-231.

H

Hallevy, G. (2013). *When Robots Kill: artificial intelligence under criminal law*. UPNE

Harrington C. et al (2000) Nursing Home Staffing and Its Relationship to Deficiencies. *Journal of Gerontology* 55B, 5, pp. 278-287

Hartzog W (2015) *Unfair and Deceptive Robots*. We Robot 2015.

Heerink, M. (2010) *Assessing Acceptance of Assistive Social Robots by Aging Adults*, Thesis completed, University of Amsterdam, Netherlands, pp. 9– 22, 41–51, 87–99.

Hegel, F., Muhl, C., Wrede, B., Hielscher-Fastabend, M., & Sagerer, G. (2009). Understanding social robots. *Second International Conferences on Advances in Computer-Human Interactions*, 2009. IEEE ACHI'09 pp. 169-174

Heetae Y. et al. (2016) User Acceptance on Wearable Devices: An Extended Perspective of Perceived Value. *Telematics and Informatics* 33, pp. 256-269

Herr, H. and Wilenfeld, A. (2003). User-adaptive Control of a Magnetorheological Prosthetic Knee. *Industrial Robot: An International Journal*, vol. 30, num.1, pp. 42-55.

Hoeflich, M. H. (1997) *Roman and Civil Law and the Development of Anglo-American Jurisprudence in the Nineteenth Century*, University of Georgia Press, pp. 9-30

Hoffman, C. (2013) El método Hoffman [The Hoffman's Method]. *Revista de Terapia Ocupacional*, vol. 10, num. 8, pp. 18-23

Hogan, S. P. et al. (2012) Food-induced Anaphylaxis: Mast Cells as Modulators of Anaphylactic Severity. *Semin Immunopathol* 34(5), pp. 643–653

Holder, C., Khurana, V., Harrison, F., & Jacobs, L. (2016). Robotics and law: Key legal and regulatory implications of the robotics age (Part I of II). *Computer Law & Security Review*, 32(3), pp. 383-402

Holler, J. et al. (2014). *From Machine-to-machine to the Internet of Things: Introduction to a New Age of Intelligence*. Academic Press

Homer A.C. and Gilleard C. (1991) Abuse of elderly people by their carers. *British Medical Journal*, ed. 9 pp. 1359-1362

Hon, W. K. et al. (2011) The Problem of 'Personal Data' in Cloud Computing - What Information is Regulated? The Cloud of Unknowing, Part 1. *International Data Privacy Law* 1 (4): 211-228; Queen Mary School of Law Legal Studies Research Paper No. 75/2011, SSRN.

Hon, W. K., Millard, C., & Singh, J. (2016). *Twenty Legal Considerations for Clouds of Things*. Available at SSRN.

Hong, C., et al. (2011). Evidence collection from car black boxes using smartphones. In *Proc. of Consumer Communications and Networking Conference* (pp. 836-837).

Horáková, J., & Kelemen, J. (2003) Čapek, Turing, von Neumann, and the 20th century evolution of the concept of machine. In *Proc. Intern. Conf. in Memoriam John von Neumann* pp. 121-135.

Horáková, J., & Kelemen, J. (2003) Robots – some cultural roots. In *Proc. 4th International Symposium on Computational Intelligence* pp. 39-50

Howard, P. N. (2015). *Pax Technica: How the Internet of things may set us free or lock us up*. Yale University Press

Huang, H. et al. (2011) Continuous Locomotion-mode Identification for Prosthetic Legs Based on Neuromuscular Mechanical Fusion. *IEEE Transactions on Biomedical Engineering*, vol. 58, num. 10, pp. 2867-2875.

Huang, X., Baker, J., & Reddy, R. (2014). A historical perspective of speech recognition. *Communications of the ACM*, 57(1), 94-103.

I

Ibana, M. (1997) Remote-brained Robots. *Proceedings of the 15th International Joint Conference on Artificial Intelligence (IJCAI-97)*, pp. 1593-1606

Ienca and E. Fosch-Villaronga (2016) Privacy and Security Issues in Assistive Technologies for Dementia. In: Jotterand, F. et al. *Assistive Technologies for Dementia*. Oxford University Press. Forthcoming.

J

Jansen, E., et al. (1982). Normal gait of young and old men and women: ground reaction force measurement on a treadmill. *Acta Orthopaedica*, pages 1–5.

Jarvis, R. (2004). A ‘Do-it-Yourself’ Segway Mobile Robot Platform. In *Proc. Australasian Conf. Robotics & Automation*

Jatsun, S. et al. (2017) Motion Control Algorithm for Exoskeleton Push Recovery in the Frontal Plane. In: Rodić, A. and Borangiu, T. (2017) *Advances in Robot Design and Intelligent Control*. *Proceedings of the 25th Conference on Robotics in the Alpe-Adria-Danube Region*. Springer Verlag Forthcoming.

Jespersen, K.R. (2008). *User Driven Product Development: Creating a User-Involving Culture*. Samfundslitteratur

Jonathan, P. J. Y., Fung, C. C., & Wong, K. W. (2009, August). Devious chatbots-interactive malware with a plot. In *FIRA RoboWorld Congress*, Springer Berlin Heidelberg, pp. 110-118.

Johnson, D. G. (2015). Technology with No Human Responsibility?. *Journal of Business Ethics*, 127(4), 707

Johnson, M., et al. (2011). *The fundamental principle of coactive design: Interdependence must shape autonomy. Coordination, organizations, institutions, and norms in agent systems VI*. Heidelberg: Springer.

Johnston, P.; Sarbahi, A.K. (2014) *The Impact of U.S. Drone Strikes on Terrorism in Pakistan and Afghanistan*. Unpublished manuscript.

Jones, R. (2015) *Personhood and Social Robotics – A Psychological Consideration*, Routledge, p. 53

Joesse, M. et al (2013) BEHAVE-II: The Revised Set of Measures to Assess Users’ Attitudinal and Behavioral Responses to a Social Robot, *Int J Soc Robotics* 5:379–388.

Joesse, M. et al. (2014). Lost in proxemics: spatial behavior for cross-cultural HRI. In *HRI 2014 Workshop on Culture-Aware Robotics*.

K

Kahn, P.H., et al. (2012). Robovie, you’ll have to go into the closet now: Children’s social and moral relationships with a humanoid robot. *Developmental Psychology*. 48, 2, 303

Kanda, T., et al. (2004) Interactive robots as social partners and peer tutors for children: A field trial. *Human-Computer Interaction*. 19, 1, 61–84

Kaplan, F. (2004). Who is afraid of the humanoid? Investigating cultural differences in the acceptance of robots. *International journal of humanoid robotics*, 1(03), 465-480

- Kaye, J., Whitley, E. A., Lund, D., Morrison, M., Teare, H., & Melham, K. (2015). Dynamic consent: a patient interface for twenty-first century research networks. *European Journal of Human Genetics*, 23(2), 141-146
- Kieseberg, P., Li, T. and Fosch Villaronga, E. (2017) *Humans Forget, Machines Remember: Artificial Intelligence and the Right to Be Forgotten*. 7th Annual Internet Law Works-in-Progress Conference, Santa Clara University School of Law, 4 March 2017
- Klein, H. G. (2003). Getting older is not necessarily getting better. *The Journal of the American Society of Anesthesiologists*, 98(4), 807-808.
- Knoops, G.A. (2012) Legal, Political and Ethical Dimensions of Drone Warfare under International Law: A Preliminary Survey. *International Criminal Law Review*, vol. 12, issue 4, pages 697-720
- Koay K.L. et al (2014), Social Roles and Baseline Proxemic Preferences for a Domestic Service Robot, *Int J of Soc Robotics* 6:469–488
- Kohler, W. J., and Colbert-Taylor, A. (2014). Current Law and Potential Legal Issues Pertaining to Automated, Autonomous and Connected Vehicles. *Santa Clara Computer & High Tech. LJ*, 31, 99
- Kokott J. and Sobotta C. (2013) The Distinction between Privacy and Data Protection in the Jurisprudence of the CJEU and the ECtHR. *International Data Privacy Law*, 3:4, pp. 222-228
- Kool, R. S. (2014). (Crime) Victims' Compensation: The Emergence of Convergence. *Utrecht Law Review*, 10(3), 14-26
- Koops B-J. et al. (2013) Robotic Technologies and Fundamental Rights. *Robotics Challenging the European Constitutional Framework*, *Int J Tech Ethics*, 4(2), pp. 15-35
- Koops, B. J. et al. (2010). Bridging the accountability gap: Rights for new entities in the information society?. *Minnesota Journal of Law, Science & Technology*, 11(2), pp. 497-561.
- Koops, B. J., & Leenes, R. (2014). Privacy regulation cannot be hardcoded. A critical comment on the 'privacy by design' provision in data-protection law. *International Review of Law, Computers & Technology*, 28(2), pp. 159-171
- Kory Westlund, J. and Breazeal, C. 2015. The interplay of robot language level with children's language learning during storytelling. *Proceedings of the 2015 ACM/IEEE International Conference on Human-Robot Interaction - Extended Abstracts (Portland, OR)*
- Kramer, J., & Scheutz, M. (2007). Development environments for autonomous mobile robots: A survey. *Autonomous Robots*, 22(2), 101-132
- Krebs, H. I., et al. (2008). A paradigm shift for rehabilitation robotics. *IEEE Engineering in Medicine and Biology Magazine*, 27(4), 61-70
- Kruse T, Basili P, Glasauer S, Kirsch A (2012) Legible robot navigation in the proximity of moving humans. In: *Workshop on advanced robotics and its social Impacts*, pp 83–88
- Krut, R., and Gleckman, H. (2013). *ISO 14001: A missed opportunity for sustainable global industrial development*. Routledge.
- Kuehn, J., & Haddadin, S. (2016). An Artificial Robot Nervous System To Teach Robots How To Feel Pain And Reflexively React To Potentially Damaging Contacts. *IEEE Robotics and Automation Letters*, 2(1), pp. 72-79
- Kuestenmacher A, Akhtar N, Plöger PG, Lakemeyer G. Towards robust task execution for domestic service robots. *J Intell Robot Syst* 2014;76(1):5.
- Kuffner, J. (2010) *Cloud-Enabled Humanoid Robots*. *Humanoids2010 Workshop "What's Next"*. Google Research. The Robotics Institute, Carnegie Mellon University
- Kuh, D. (2014) *A Life Course Approach to Healthy Ageing*. Oxford University Press.

Kwak, S. S. et al. (2013) What Makes People Empathize with an Emotional Robot? The Impact of Agency and Physical Embodiment on Human Empathy for a Robot. International Symposium on Robot and Human Interactive Communication, Korea

L

Laukyte, M. (2013). The capabilities approach as a bridge between animals and robots. European Institute of Florence.

Lawton, M.P. and Brody, E.M. (1969) Assessment of older people: Self-maintaining and instrumental activities of daily living. *The Gerontologist*, 9(3), pp. 179-186.

Lee, K. et al. (2005) Can a Robot Be Perceived as a Developing Creature? Effects of a Robot's Long-term Cognitive Developments on its Social Presence and People's Social Responses towards it. *Human Communication Research* 31, pp. 538-563

Lee, H.J. and Jung, S. (2010) Guidance Control of a Wheeled Mobile Robot with Human Interaction Based on Force Control, *International Journal of Control, Automation, and Systems* 8(2) pp. 361-368

Leenes, R., and Lucivero, F. (2014). Laws on robots, laws by robots, laws in robots: Regulating robot behaviour by design. *Law, Innovation and Technology*, 6(2), pp. 193-220

Leite, I. et al. (2013), Social Robots for Long-Term Interaction : A Survey, *International Journal of Social Robotics*, pp. 291–308

Lessig, L. (2006) *Code Version 2.0*. Basic Books, NY

Lutz, C., and Tamò, A. (2015). RoboCode-Ethicists: Privacy-friendly robots, an ethical responsibility of engineers?. In *Proceedings of the 2015 ACM SIGCOMM Workshop on Ethics in Networked Systems Research* pp. 27-28

Lutz, C., & Tamò, (2016) A. Privacy and Healthcare Robots—An ANT Analysis. *WeRobot 2016*, 30 March – 1 April, Miami, U.S

M

Malle, B., Kieseberg, P., Weippl, E., & Holzinger, A. (2016). The right to be forgotten: towards machine learning on perturbed knowledge bases. In *International Conference on Availability, Reliability, and Security*, Springer, pp. 251-266.

Mann, S. (2012) Wearable Computing. In: Soegaard, M., & Dam, R. F. (2012). *The Encyclopedia of Human-Computer Interaction*. The Encyclopedia of Human-Computer Interaction.

Marchant, G. E., & Lindor, R. A. (2012). The coming collision between autonomous vehicles and the liability system. *Santa Clara Law Review*, 52(4), 1321–1340.

Marmot, M. (2002). The influence of income on health: views of an epidemiologist. *Health affairs*, 21(2), 31-46.

Marti, P. et al. (2009) A Robotic Toy for Children with Special Needs: From Requirements to Design. *IEEE 11th International Conference on Rehabilitation Robotics*. Kyoto International Conference Center

Massaro, T. N. and Norton, H. (2016) Seriously? Free Speech Rights and Artificial Intelligence. *Northwestern University Law Review*, v. 110.

Mast M et al (2015) Semi-Autonomous Domestic Service Robots: Evaluation of a User Interface for Remote Manipulation and Navigation With Focus on Effects of Stereoscopic Display, *Int J of Soc Robotics* 7, pp. 183–202

Matthias, A. (2004). The responsibility gap: Ascribing responsibility for the actions of learning automata. *Ethics and Information Technology*, 6(3), pp. 175–183.

Matsui T et al (2015) Development of a Power-Assisted Wheelchair with Consideration of Driving Environment – Dynamic Estimation of Slope Angle and

Adaptive Control System Design. *International Journal of Materials Science and Engineering* 3:1, pp. 25-30.

Mayer-Schönberger, V, and Cukier, K. (2013) Big data. A revolution that will transform how we live, work and think. John Murray

McCallig, D. (2014) Facebook after Death: an Evolving Policy in a Social Network. *International Journal of Law and Information Technology*, vol. 22, no. 2, pp. 107-140.

Medaglia, C. M., and Serbanati, A. (2010). An overview of privacy and security issues in the internet of things. In *The Internet of Things*, Springer New York, pp. 389-395.

Michalowski M, Sabanovic S, Simmons R (2006) A spatial model of engagement for a social robot. In: 9th IEEE international work- shop on advanced motion control, pp 762–767

Millar, J. (2015) Technological Moral Proxies and the Ethical Limits of Automating Decision-Making In Robotics and Artificial Intelligence. Ph.D. Dissertation Queen's University, Ontario, Canada

Minsky, M. (1988). *Society of mind*. Simon and Schuster. Prologue, p. 17

Mitzner, T.L. (2014) Identifying the Potential for Robotics to Assist Older Adults in Different Living Environments. *Int J soc Robotics* 5, pp. 379-388

Miwa, H., et al. (2001). Experimental study on robot personality for humanoid head robot. *International Conference on Intelligent Robots and Systems, 2001. Proceedings. 2001 IEEE/RSJ Vol. 2*, pp. 1183-1188.

Moller, N. (2012) The concepts of risk and safety. In S. Roeser, R. Hillerbrand, P. Sandin, and M. Peterson, Eds. (2012) *Handbook of Risk Theory*, Dordrecht, Netherlands: Springer, pp. 55–85

Moreno, J.C. et al. (2014) Symbiotic Wearable Robotic Exoskeletons: The Concept of the BioMot Project. In: Jacucci et al. (Eds.) *Symbiotic 2014, LNCS 8820*, pp. 72-83.

Muñoz, J et al (2006) A Description of the SENA Robotic Wheelchair. *IEEE MELECON*, pp. 437-440.

Mutlu B., et al., (2009) Footing In Human-Robot Conversations: How Robots Might Shape Participant Roles Using Gaze Cues. *ACM/IEEE HRI*, pp. 61-68

N

Nagenborg, M., et al. (2008). Ethical regulations on robotics in Europe. *AI and Society*, 22(3), pp. 349–366

Nakabo, Y. (2011) Safety of Personal Care Robots as an Example of Consumer Devices. *OMG Technical Meeting Special Event. Seminar on Systems Assurance & Safety for Consumer Devices: Automotive, Robotic & Building Automation Systems for the Future.*

Nakano, Y. I., et al. (2013). Implementation and evaluation of a multimodal addressee identification mechanism for multiparty conversation systems. In *Proceedings of the 15th ACM on International conference on multimodal interaction*, pp. 35-42.

Nguyen, H. G., & Bott, J. P. (2001). Robotics for law enforcement: Applications beyond explosive ordnance disposal. In Simon K. Bramble; Edward M. Carapezza; Lenny I. Rudin (2001) *Enabling Technologies for Law Enforcement*, pp. 433-454.

Nijhawan, L. P. et al. (2013) Informed Consent: Issues and Challenges. *J Adv Pharm Technol Res*, 4(3), pp. 134-144.

Noda et al. (2012) Brain-Controlled Exoskeleton Robot for BMI Rehabilitation. *IEEE-RAS International Conference on Humanoid Robots*, pp. 21-27

Novikova J K and Watts L (2015) Towards Artificial Emotions to Assist Social Coordination in HRI, *Int J of Soc Robotics* 7:77–88.

Nozawa, M., Sankai, Y. (2002) Control Method of Walking Speed and Step Length for Hybrid Assistive Leg. *ICCHP 2012, LNCS 2398*, pp. 220-227.

Nussbaum, M. C. (2011). *Creating capabilities*. Harvard University Press.
Nwana, H. S. (1996). Software agents: An overview. *Knowledge Engineering Review*, 11(03), Cambridge University Press, pp. 1-40

O

Olivier, J. (2016) *Development of Walk Assistive Orthoses for Elderly*. Thesis 6947. EPFL, Lausanne, Switzerland.

Osborne, M. A. (2013) *The Future of Employment: How Susceptible Are Jobs to Computerization?*

Ossowski, S., Sierra, C., & Botti, V. (2013). *Agreement Technologies: A Computing perspective*. In *Agreement Technologies* (pp. 3-16). Springer Netherlands.

P

Pagallo, U. (2013). *The laws of robots. Crimes, Contracts, and Torts*. Berlin, Dartmouth: Springer

Paiva, A., Leite, I., & Ribeiro, T. (2014). Emotion modeling for social robots. *The Oxford Handbook of Affective Computing*, 296.

Petisca, S. et al. (2015). *More Social and Emotional Behaviour May Lead to Poorer Perceptions of a Social Robot*. In *Social Robotics*, Springer International Publishing, pp. 522-531.

Pistono, F. (2014). *Robots will steal your job, but that's ok: how to survive the economic collapse and be happy*. Federico Pistono

Pistono, F., & Yampolskiy, R. V. (2016). *Unethical Research: How to Create a Malevolent Artificial Intelligence*

Power, D. J., Sharda, R., & Burstein, F. (2015). *Decision support systems*. John Wiley & Sons, Ltd.

R

Reelick, M., et al. (2009). The influence of fear of falling on gait and balance in older people. *Age and ageing*, 38(4):435–440.

Reiser U et al (2013) *Care-O-bot@ 3 – Vision of a Robot Butler*. In: Trapp R (ed) *Your Virtual Butler*, LNAI 7407, pp. 97–116.

Reisberg, B., Ferris, S.H., de Leon, M.J., and Crook, T. (1982) *The global deterioration scale for assessment of primary degenerative dementia*. *American Journal of Psychiatry*

Reppou, S., & Karagiannis, G. (2015) *Robots and seniors: can they be friends?* Workshop on the Legal, Ethical and Social Issues for Social Robots in Therapy and Education at Newfriends2015 Conference, Almere, The Netherlands.

Resnick, M. et al. (2000) *Beyond black boxes: Bringing transparency and aesthetics back to scientific investigation*. *The Journal of the Learning Sciences*, 9(1), 7-30.

Rest, J. van et al., (2012) *Designing privacy-by-design*. Springer Berlin Heidelberg, pp. 55-72

Richards N. M. and Smart, W. D. (2016) *How Should the Law Think about Robots?* In: Calo, R. et al. (2016) *Robot Law*, Edward Elgar Publishing, pp. 3-22

Richardson, K. (2016). *Sex Robot Matters: Slavery, the Prostituted, and the Rights of Machines*. *IEEE Technology and Society Magazine*, 35(2), 46-53.

Rios-Martinez J et al (2015) *From Proxemics Theory to Socially-Aware Navigation: A Survey*, *Int J of Soc Robotics* 7:137–153

- Robinson H. et al (2014) The Role of Healthcare Robots for Older People at Home: A Review, *Int J of Soc Robotics* 6:575–591
- Rodić, A., Vujović, M., Stevanović, I., & Jovanović, M. (2016). Development of Human-Centered Social Robot with Embedded Personality for Elderly Care. In *New Trends in Medical and Service Robots* (pp. 233-247). Springer International Publishing.
- Roemer, J. (1996) *Theories of Distributive Justice*. Cambridge: Harvard University Press.
- Roider, D. et al. (2015). Segway® related injuries in Vienna: report from the Lorenz Böhler Trauma Centre. *European journal of trauma and emergency surgery*, 1-3
- Rose, K., et al. (2015). The internet of things: An overview. The Internet Society (ISOC).
- Rubenstein, L.Z. (2006) Falls in Older People: Epidemiology, Risk Factors and Strategies for Prevention. *Age and Ageing* 35-S2: ii37-ii41 (2006)
- Rupal, B.S., Singla A. and Virk, S. (2016). Lower Limb Exoskeletons: A Brief Review. Researchgate.

S

- Salem M. et al. (2015) Towards Safe and Trustworthy Social Robots: Ethical Challenges and Practical Issues. In: Tapus, A. et al. (eds.) (2015) *ICSR, LNAI 9388*, pp. 584-593.
- Salvini, P. (2015) On Ethical, Legal and Social Issues of Care Robots. In S. Mohammed et al. (eds.) (2015) *Intelligent Assistive Robots*, Springer, pp. 431-445
- Sandel, M. J. (2010). *Justice: What's The Right Thing To Do?* Macmillan
- Santoro, M. et al. (2008). Learning robots interacting with humans: from epistemic risk to responsibility. *AI and Society*, 22(3), pp. 301–314
- Satake, S., Kanda, T., Glas, D. F., Imai, M., Ishiguro, H., & Hagita, N. (2009, March). How to approach humans?-strategies for social robots to initiate interaction. 4th ACM/IEEE International Conference on Human-Robot Interaction (HRI), 2009, pp. 109-116
- Scheutz, M. (2011). 13 The Inherent Dangers of Unidirectional Emotional Bonds between Humans and Social Robots. In Lin, P. et al. (2011) *Robot Ethics: The Ethical and Social Implications of Robotics*, section 6, p. 213
- Scheutz, M., et al. (2006). The utility of affect expression in natural language interactions in joint human-robot tasks. In *Proceedings of the 1st ACM SIGCHI/SIGART conference on Human-robot interaction* (pp. 226-233)
- Scheutz, M., & Crowell, C. (2007). The burden of embodied autonomy: Some reflections on the social and ethical implications of autonomous robots. In *Workshop on Roboethics at the International Conference on Robotics and Automation, Rome*
- Scheutz, M. (2013, July). Computational mechanisms for mental models in human-robot interaction. In *International Conference on Virtual, Augmented and Mixed Reality* (pp. 304-312). Springer Berlin Heidelberg
- Schopper, A. W., and Cote, D. O. (1984). *Anthropometric Cockpit Compatibility Assessment of US Army Aircraft for Large and Small Personnel Wearing a Training, Warm-Weather Clothing Configuration* (No. USAARL-84-10). Army Aeromedical Research Lab Fort Rucker Al.
- Scott, N. (2001) Ambiguity versus Precision: The Changing Role of Terminology in Conference Diplomacy. In: Kurbalija, J. and Slavik, H. (2001) *Language and Diplomacy*, p. 153
- Sharkey, N.; Goodman, M.; Ross, N. (2010) *The Coming Robot Crime Wave*. IEEE Computer Society

- Sharkey, A. and Sharkey, N. (2010) *Granny and the Robots: Ethical Issues in Robotic Care for the Elderly*. *Ethics and Inf Technol*, pp. 27-40
- Sharkey, A. (2014). *Robots and human dignity: a consideration of the effects of robot care on the dignity of older people*. *Ethics and Information Technology*, 16(1), 63-75
- Shelton, D. (2003). *Commitment and compliance: The role of non-binding norms in the international legal system*. Oxford University Press.
- Shiomi M et al (2015) Effectiveness of Social Behaviors for Autonomous Wheelchair Robot to Support Elderly People in Japan. *PLoS ONE* 10(5), pp. 1-15.
- Shukla, J.et. al. (2015) A Case Study of Robot Interaction Among Individuals with Profound and Multiple Learning Disabilities. *ICSR 2015*, Springer International Publishing, pp. 613–622
- Shukla, J. et al. (2015) A Comparison of Robot Interaction with Tactile Gaming Console Stimulation in Clinical Applications. *Second Iberian Robotics Conference: Advances in Robotics, Volume 2*, Springer International Publishing, pp. 435–445.
- Sim D.Y.Y. and Loo C.K. (2015) Extensive Assessment and Evaluation Methodologies on Assistive Social Robots for Modeling Human-Robot-Interaction – A Review, *Information Science* vol. 301, 2015, pp. 305-344
- Simon, H. A. (1996) *The Science of the Artificial*. MIT Press, Cambridge, Massachusetts.
- Singer, P. W. (2009). *Wired for war: The robotics revolution and conflict in the 21st century*. Penguin
- Soltana, A. (2016) A Model-Based Framework for Legal Policy Simulation and Legal Compliance Checking. *IEEE 24th International Requirements Engineering Conference*, Beijing, China
- Sorell, T. and Heather D. (2014) Robot carers, ethics, and older people. *Ethics and Information Technology* 16.3, pp. 183-195
- Sors Emilsson L (2015) How to Reach Our Patients That Will Benefit From Robotic-Assisted Rehabilitation. *Workshop Bridging the Gaps Between Different Worlds A Legal and Ethical Approach towards Assistive Robots: Risks And Solutions*. 1st New Friends Conference 2015.
- Souza L et al. (2007) Young People’s Experiences Using Electric Power Indoor-Outdoor Wheelchairs (EPIOCs): Potential for Enhancing User’s Development? *Disability and Rehab* 29:16, pp. 1281-1294.
- Souza, J. M. et al. (2014) Advances in Transfemoral Amputee Rehabilitation: Early Experience with Targeted Muscle Reinnervation. *Curr Surg Rep* 2:51.
- Sparrow, R. (2007). Killer robots. *Journal of applied philosophy*, 24(1), 62–77
- Sparrow, R., and Sparrow, L. (2006) In the hands of machines? The future of aged care. *Minds and Machines*, 16, pp. 141–161
- Steinert, S. (2014). The Five Robots—A Taxonomy for Roboethics. *International Journal of Social Robotics*, 6(2), pp. 249-260.
- Stephan, A. (2015) Empathy for Artificial Agents. *Int J Soc Robotics* 7, pp. 111-116
- Stradella, E. et al. (2012). Robot Companions as Case-Scenario for Assessing the “Subjectivity” of Autonomous Agents. *Some Philosophical and Legal Remarks*. *Autonomous Agents (RDA2)*, 25
- Swan, M. (2012). Health 2050: The realization of personalized medicine through crowdsourcing, the quantified self, and the participatory biocitizen. *Journal of Personalized Medicine*, 2(3), 93-118.
- Swan, M. (2013). The quantified self: Fundamental disruption in big data science and biological discovery. *Big Data*, 1(2), 85-99.
- Syrdal, D. S., Walters, M. L., Otero, N., Koay, K. L., & Dautenhahn, K. (2007). He knows when you are sleeping-privacy and the personal robot companion. In *Proc.*

workshop human implications of human–robot interaction, association for the advancement of artificial intelligence (AAAI'07), pp. 28-33.

T

Talebifard P et al (2014) A Risk Assessment Infrastructure for Powered Wheelchair Motion Commands without Full Sensor Coverage. IROS, pp. 3592-3597.

Tamura Y, Fukuzawa T, Asama H (2010) Smooth collision avoidance in human-robot coexisting environment. In: IEEE/RSJ inter-national conference on intelligent robots and systems, pp 3887– 3892

Tapus, A., Mataric, M. J., & Scassellati, B. (2007). Socially assistive robotics. *IEEE Robotics and Automation Magazine*, 14(1), 35

Tedrake, R., et al. (2015, November). A closed-form solution for real-time ZMP gait generation and feedback stabilization. *IEEE-RAS 15th International Conference on Humanoid Robots (Humanoids)*, 2015 , pp. 936-940.

Teubner, G. (2006). Rights of non-humans? Electronic agents and animals as new actors in politics and law. *Journal of Law and Society*, 33(4), pp. 497-521

Tisseron, S. et al. (2015) Testing Empathy with Robots: A Model in Four Dimensions and Sixteen Items. *Int J Soc Robotics* 7, pp. 97-102

Torta, E., Oberzaucher, J., Werner, F., Cuijpers, R. H., & Juola, J. F. (2012). Attitudes towards socially assistive robots in intelligent homes: results from laboratory studies and field trials. *Journal of Human-Robot Interaction*, 1(2), 76-99

Traum, D. R., & Allen, J. F. (1994, June). Discourse obligations in dialogue processing. In *Proceedings of the 32nd annual meeting on Association for Computational Linguistics* (pp. 1-8). Association for Computational Linguistics

Tucker, M. R. et al. (2015). Control strategies for active lower extremity prosthetics and orthotics: a review. *Journal of neuroengineering and rehabilitation*, 12(1), 1.

Turing, A. M. (1950). Computing machinery and intelligence. *Mind*, 59(236), pp. 433-460

Turner, P. J. et al. (2015) Increase in Anaphylaxis-related Hospitalizations but no Increase in Fatalities: An analysis of United Kingdom National Anaphylaxis Data, 1992-2012". *J Allergy Clin Immunol* 135(4), pp. 956–963.

U

Uvanesh, K., Nayak, S. K., Champaty, B., Thakur, G., Mohapatra, B., Tibarewala, D. N., & Pal, K. (2016). Development of a Surface EMG-Based Control System for Controlling Assistive Devices: A Study on Robotic Vehicle. In *Classification and Clustering in Biomedical Signal Processing*, pp. 335-355.

V

Vallor, S. (2011) Carebots and caregivers: Sustaining the ethical ideal of care in the 21st century. *Journal of Philosophy and Technology*, 24, pp. 251–268

Varshney, K. R. et al. (2013) Practical ensemble classification error bounds for different operating points, *IEEE Trans. Knowl. Data Eng.*, vol. 25, no. 11, pp. 2590–2601

Varshney, K. R. (2016). *Engineering Safety in Machine Learning*. Open Access

Vasic, M., & Billard, A. (2013, May). Safety issues in human-robot interactions. *International Conference on Robotics and Automation (ICRA)*, 2013 IEEE pp. 197-204.

- Vázquez, M., et al. (2011, March). ShakeTime! A deceptive robot referee. In 2011 6th ACM/IEEE International Conference on Human-Robot Interaction (HRI), pp. 403-403.
- Viebrock, E. (2008). Systematic literature reviews as a tool for evidence-based policy. ECPR Joint Sessions in Rennes, pp. 11-16.
- Virk, G. S., Haider, U., Indrawibawa, I. N., Thekkeparamadom, R. K., & Masud, N. (2014, July). EXO-LEGS for elderly persons. In 17th International Conference on Climbing and Walking Robots (CLAWAR), JUL 21-23, 2014, Poznan, POLAND, pp. 85-92.

W

- Walters, M. L., Dautenhahn, K., Te Boekhorst, R., Koay, K. L., Syrdal, D. S., & Nehaniv, C. L. (2009). An empirical framework for human-robot proxemics. *Procs of new frontiers in human-robot interaction*.
- Wang C et al (2013) A Collision Avoidance Strategy for Safe Autonomous Navigation for an Intelligent Electric-Powered Wheelchair in Dynamic Uncertain Environments with Moving Obstacles. *European Control Conference*, pp. 4382-4387.
- Wang, Y. and Kobsa, A. (2008) Privacy Enhancing Technologies. In: M. Gupta and R. Sharman, eds. (2008) *Handbook of Research on Social and Organizational Liabilities in Information Security*. Hershey, PA: IGI Global, pp. 203-227
- Ward, J.C. (2014) Oncology Reimbursement in the Era of Personalized Medicine and Big Data. *Journal of Oncology Practice*, vol. 10, issue 2, pp. 83-86
- Wee, R., Henaghan, M., & Winship, I. (2013). Ethics: Dynamic consent in the digital age of biology: online initiatives and regulatory considerations. *Journal of primary health care*, 5(4), 341-347
- Welch, K. C., et al. (2010). An approach to the design of socially acceptable robots for children with autism spectrum disorders. *International Journal of Social Robotics*, 2, 391-403
- Weng, Y. H., Sugahara, Y., Hashimoto, K., & Takanishi, A. (2015). Intersection of “Tokku” special zone, robots, and the law: a case study on legal impacts to humanoid robots. *International Journal of Social Robotics*, 7(5), 841-857
- Westlund, J.K. and C. Breazeal, (2015) “Deception, Secrets, Children and Robots: What’s Acceptable?” HRI 2015 Workshop, Portland, US.
- Wolbring G. et al (2014) Social Robots: Views of Staff of a Disability Service Organization, *Int J of Soc Robotics* 6:457-468.
- Wright, D., & De Hert, P. (2012). *Privacy Impact Assessment*. Springer Netherlands.
- Wright, D., Friedewald, M., & Gellert, R. (2015). Developing and testing a surveillance impact assessment methodology. *International Data Privacy Law*, 5(1), 40-53
- Wright, D.; Wadhwa, K. (2012) A Step-by-step Guide to Privacy Impact Assessment. II PIAF Workshop. Poland
- Wynsberghe A. van (2013) Designing Robots for Care: Care-Centered Value-Sensitive Design. *Sci Eng Ethics* 19, pp. 407-433.
- Wynsberghe, A. (2012) Designing Robots with Care Creating a Framework for the Future Design and Implementation of Care Robots. Doctoral Dissertation, University of Twente, Enschede.

X

Xiao, Y.; Zhang, Z. and Thalmann, D. (2013) Human-Robot Interaction by Understanding Upper Body Gesture Understanding. Proceedings 19th ACM Symposium on Virtual Reality Software and Technology (VRST), pp.133-142

Y

Yamaki, K. (2012) et al. Application of Robot Suit HAL to Gait Rehabilitation of Stroke Patients: A Case Study. ICCHP 2012, Part II, LNCS 7383, pp. 184-187.

Z

Zaghlami, L. (2016) How Religious Beliefs Deal with Robotization. New Friends 2016, Conference Proceedings. Ethical, Legal and Societal Issues of Robots in Therapy and Education Workshop.

Zaratti, M., et al. (2006). A 3D simulator of multiple legged robots based on USARSim. In Robot Soccer World Cup, Springer Berlin Heidelberg, pp. 13-24.

Zhang, F. et al. (2011) Preliminary Design of a Terrain Recognition System. Conference Proceedings IEEE EMBS, pp. 5452-5455

Zhang, F. et al. (2012) Preliminary Study of the Effect of the User Intention Recognition Errors on Volitional Control of Powered Limbs Prostheses. 34th International Conference of the IEEE Engineering in Medicine and Biology Society

Zhang, Q., Chen M., Xu, L. (2012) Kinematics and Dynamics Modeling for Lower Limbs Rehabilitation Robot. ICSR 2012, LNAI 7621, pp. 641-649.

Zielinska, T. (2014) History of Service Robots. Information Resources Management Association, dir. Robotics: Concepts, Methodologies, Tools, and Applications. USA, ING. Global

Zuo, X., et al. (2010). Detecting robot-directed speech by situated understanding in physical interaction. Information and Media Technologies, 5(4), 1314-1326

2. Non-academic Papers

A

Ackerman, E. (2015) DARPA Tests Battery-Powered Exoskeletons on Real Soldiers IEEE Spectrum

Anonymous (2012) You, Robot? The Economist.

B

Baar, A. (2015) Google Mistakenly Tags Black People as 'Gorillas,' Showing Limits of Algorithms. Wall Street Journal

Baar, A. (2015) Google's YouTube Kids Criticized for "Inappropriate Content". Wall Street Journal

Ballaban, M. (2015). Mercedes, Google, Volvo To Accept Liability When Their Autonomous Cars Screw Up. Jalopnik.

Barghava, S. and Didia, D. (1992) Automated Guided Vehicle Time-Out Analysis. University of Michigan Hospital.

BBC (2015) Not in front of the telly: Warning over 'listening' TV.

Beckland, R. (2015) The Digital Health Trends Poised to Transform Healthcare in 2015. Validic

Berman, D. K. (2013) Daddy, What Was A Truck Driver? - Over the Next Two Decades, the Machines Themselves Will Take Over the Driving. The Wall Street Journal

Blanco, R. (2013) Robots: Slavery in the Digital Age. Daily Reckoning

Blennerhassett, P. (2016) U.S. military to test SFU-invented bionic exoskeletons. Gizmag.

Borghino, D. (2016) Would you buy a car programmed to kill you for the greater good? Gizmag.

C

Carrol, S. (2016) Goodbye privacy, hello 'Alexa': Amazon Echo, the home robot who hears it all. The Guardian.

Cavoukian, A. (2011) 7 Foundational Principles of Privacy by Design

D

Dale, B. (2016) Humans 2.0: People and AI Will Probably Team Up. Observer.

Darling, K. (2015) Children Beating Up Robot Inspires New Escape Maneuver System. IEEE Spectrum.

Diaz, C-A. (2016) Saatchi's New Directors' Showcase Features an A.I.-Created Film. In Creativity.

F

Falconer, J. (2013) Unleash the Kraken! Robot octopus learning to swim. New Atlas.

Fingas, J. (2014) Robotic exoskeletons give dock workers superhuman lifting abilities. Engadget.

G

Garfield, L. (2016) 7 companies that are replacing human jobs with robots. Business Insider.

H

Hamblen M. (2015) UL Creating a Standard for Wearable Privacy and Security. Computerworld.

Hempel, J. (2015) Facebook Launches M, Its Bold Answer to Siri and Cortana. Wired Business.

Hustinx, P. (2013) Ethical Dimensions on Data Protection and Privacy. European Data Protection Supervisor (EDPS)

J

Jessica, F. (2016) Elon Musk Opens \$1 Billion "Robot Gym" for Artificial Intelligence Training. Nature World News.

K

Kobie, N. (2015) Why the cookies law wasn't fully baked – and how to avoid being tracked online. The Guardian.

Khullar, D. (2016) Helping Patients Make the Right Decisions. New York Times, September.

Kravetz, A. M. (2012) Toys Cars Offer Mobility to Children with Disabilities. Live Science

L

Lazzaro, S. (2016) IBM Watson Has Learned to Make Cocktails and Compose Music. Observer.

Leigh, A. (2016) Is an algorithm any less racist than a human? The Guardian.

Le Monde (2012) Le label "TÜV", une institution en Allemagne [The Label TÜV, an institution in Germany]

Les voitures de demain (2012) Inriality.

M

Madrigal, A.C. (2012) How Google Builds Its Maps—and What It Means for the Future of Everything. The Atlantic.

Madrigal, A.C. (2012) The Trick That Makes Google's Self-Driving Cars Work. The Atlantic.

Marszalek, J. (2013) Classification Discussion: Mechanical Wheelchairs. FDA.

Miller, C. C. (2015) When Algorithms Discriminate. New York Times.

Mitchell, T. M. (2006). The discipline of machine learning, Carnegie Mellon University.

Moss, F. (2016) Robots on Track to Bump Humans From Call-Center Jobs. The Wall Street Journal.

N

Nelson, R. (2015) Robot Safety Standard Update. Robotics.org.

P

Petersen, A. (2016) The driverless car is coming, and it's going to automate millions of jobs. Crunch Network

Place, N. (2016) Watch This Robot Dog Slip on Banana Peels. The Daily Beast.

Ponsford, M. (2013) Robot exoskeleton suits that could make us superhuman, CNN.

Power, M. (2014) What Happens When a Software Bot Goes on a Darknet Shopping Spree? The Guardian.

R

Regan, T. (2017) Virginia is the First to Legalize Delivery Robots. You better start getting used to a more crowded sidewalk. Engadget.

Rundle, M. (2013) Hyundai E4U: Egg-Shaped Futuristic Vehicle Rolls Without Wheels - Kinda (PICTURES)

Russon, M-A (2015) Kuratas: Giant wearable mecha robot suit currently for sale on Amazon Japan for \$1m. International Business Times.

S

Science Alert Staff (2014) New wearable robotic exoskeleton gives you superhuman powers. Science Alert.
Sharkey, N. (2007) Robot wars are a reality. The Guardian.
Sherwood, H. (2016) Robot monk to spread Buddhist wisdom to the digital generation. The Guardian.

V

Vanstone, L. (2016) In the driverless future, what happens to drivers' jobs? Houston Chronicle.
Vincent, J. (2016) Twitter taught Microsoft's AI chatbot to be a racist asshole in less than a day. The Verge.
Virk, G. (2014) New ISO 13482 Robot Safety Standard Published. Clawar.org.

W

Warren, T. (2016) This autonomous, 3D-printed bus starts giving rides in Washington, DC today. The Verge.

1. Norms, standards, judgements and opinions

A

Article 29 Working Party Opinion 04/2007 on the concept of personal data.
Article 29 Working Party, Opinion 5/2009 on Online Social Networking.
Article 29 Working Party, Opinion 01/2012 on the data protection reforms proposals, adopted in March 23rd 2012
Article 29 Working Party Opinion 02/2013 on apps on smart devices
Article 29 Working Party, Opinion 8/2014 on the on Recent Developments on the Internet of Things

B

British Standard 8611:2016 on the ethical design of robots

C

Convention on the Elimination of all Forms of Racial Discrimination
Convention on the Elimination of All Forms of Discrimination Against Women
Convention on the Rights of the Persons with Disabilities

D

Directive 90/385/EEC on the approximation of the laws of the Member States relating to active implantable medical devices, abbreviated as AIMDD
Directive 93/42/EEC concerning medical devices (as amended by Directive 2007/47/EC), Medical Device Directive
Directive 2006/42/EC of the European Parliament and of the Council of 17 May 2006 on machinery

E

European Commission Proposal 2015/0278 (COD) of a Directive on the approximation of the laws, regulations and administrative provisions of the Member States as regards the accessibility requirements for products and services
European Convention of Human Rights

I

International Covenant on Economic, Social and Cultural Rights
ISO 8373:2012 Robots and Robotic Devices – Vocabulary
ISO 12100:2010 Safety of Machinery – General Principles for Design – Risk Assessment and Risk Reduction
ISO 13482:2014 Robots and Robotics Devices – Safety Requirements for Personal Care Robots
ISO 27005:2011, Information Technology – Security Techniques – Information Security Risk Management
ISO/TS 13582:2013 Health informatics -- Sharing of OID registry information

J

Jacobellis v. Ohio, 378, US 184 (2964)

O

Operational Rules on Small Unmanned Aircraft Systems, Federal Aviation Agency, US.

P

Patent WO2013130656 A1 Gyroscope Stabilization for Two-wheeled Vehicles (2013) from Lit Motor Corporation
Patent US 20140005577 A1 Airbag for exoskeleton device
Patent US 8 996 429 B1, Google, Methods and systems for robot personality development, March 31, 2015

R

Regulation (EU) 679/2016 on the protection of natural persons with regard to the processing of personal data and on the free movement of such data

S

Softbot Lab: www.softbotlabs.com/Home/

U

Universal Declaration of Human Rights

W

Worker's disability compensation act from 1969, Michigan

3. Reports, resolutions, projects and studies

A

Artificial Companions as a New Kind of Interface to the Future Internet. (2006) Oxford Internet Institute Research report No. 13.

B

Big Data and Smart Devices and Their Impact on Privacy (2015) DG for Internal Policies. Policy Department. Citizen's Rights and Constitutional Affairs.
British Standard Organization: www.bsigroup.com

C

Commission Nationale de l'Informatique et des Libertés (CNIL) (2012) Methodology for Privacy Risk Management. How to Implement the Data Protection Act.
Commission Recommendation 2012/148/EU on the Data Protection Impact Assessment Template for Smart Grid and Smart Metering Systems
CQC (2012) Annual Report and Accounts. Care Quality Commission. United Kingdom.

D

DaVinci Surgery System: www.davincisurgery.com
DOMEO Project. AAL-2008-1-159. ID: R-BME-1_0-D4.3 D4.3 Risk Assessment/ISO Links.

E

EDPS Annual Report Annual Report of the EDPS of 2015:
secure.edps.europa.eu/EDPSWEB/webdav/site/mySite/shared/Documents/EDPS/Publications/Annualreport/2015/EDPS_Annual_Report_2015_Web_EN.pdf
Eurobarometer 382's report on Public Attitudes Towards Robots, Wave EB77.1 – TNS Opinion & Social (2012).
Eurobarometer 427 on Autonomous Systems (2015)
euRobotics (2010-2012) ELS Issues in Robotics
euRobotics (2013-2016) Regulating Emerging Robotic Technologies in Europe: Robotics facing Law and Ethics
European Aviation Safety Agency EASA (2015) Introduction of a regulatory framework for the operation of drones
European Harmonized Standards: ec.europa.eu/growth/single-market/european-standards/harmonised-standards/index_en.htm
European Network of Living Labs (ENoLL) (2015). Citizen-Driven Innovation – A Guidebook for City Mayors and Public Administrators.
European Parliament 2015/2103(INL) Resolution on Civil Law Rules on Robotics, February 2017.
European Parliament's Committee on Legal Affairs, Policy Department for "Citizens' Rights and Constitutional Affairs Study on European Civil Law Rules in Robotics of October 2016
European Parliament Research Service (2016) Automated Vehicles in the EU.

European Road Transport Research Advisory Council (2015) Automated Driving Roadmap

Exoskeleton Report (2015): exoskeletonreport.com/2015/10/otherlab-orthotics-a-fundamental-jump-in-technology/

Exoskeleton Report (2016): exoskeletonreport.com/2016/08/exoskeleton-industry-2016/

G

Genworth (2013) Cost of Care Survey. Home Care Providers, Adult Day Health Care Facilities, Assisted Living Facilities and Nursing Homes. 10th Edition

Guidelines relating to the application of the council directive 90/385/EEC on active implantable medical devices and the council directive 93/42/EEC on medical devices. Ref. MEDDEV 2.1/1 Medical Device Guidance Document

H

Health Service Planning and Policy-Making. A Toolkit for Nurses. Module 2: Stakeholder Analysis and Networks. World Health Organization, Western Pacific Region

K

KPMG (2013) Observatoire des Établissement d'hébergement pour personnes âgées dépendantes [*Observatory for accommodation facilities for elderly dependent people*]

L

Long Lasting Memories – Mind and Body Fitness for Live (LLM) Project (2008) ICT-PSP Program: ICT for ageing well with cognitive problems, combining assistive and independent living technologies

M

Market Research Reports Biz. (2013) Wearable Technology Market - Global Scenario, Trends, Industry Analysis, Size, Share And Forecast, 2012 – 2018.

N

National collaborating Centre for Healthy Public Policy. (2010) Four Types of Impact Assessment Used in Canada

P

Privacy Commissioner of Canada (OPC) Guidance Documents (2012) Seizing Opportunity: Good Privacy Practices for Developing Mobile Apps

Privacy Commissioner of Canada (OPC) Guidance Documents (2014) Wearable Computing.

PWC (2014) The Wearable Future. Consumer Intelligent Series.

R

Robolaw Project (2014) Deliverable D 6.2, Guidelines on Regulating Robots.
Robotics 2020 Multi-Annual Roadmap For Robotics in Europe. Call 2 ICT 24 Horizon
2020, SPARC, 2015, p. 287
ROCKEU (2016) ELS issues in robotics and steps to consider them. Part 2: Robotics
and Regulations.

S

Serpentine Future Transport: www.serpentine.ch/p_systeme/Systeme.html
SPARC Robotics 2020 Multi-Annual Roadmap (2015). For Robotics in Europe. Call
2 ICT 24 Horizon 2020, SPARC, p. 287
Special Eurobarometer 382's report (2012) Public Attitudes Towards Robots", Wave
EB77.1 – TNS Opinion & Social
STOA (2012) Legal and Ethical Reflections Concerning Robotics.
Suggestion for a green paper on legal issues in robotics (2012) Contribution to
Deliverable D, 3(1) on ELS issues in Robotics.

T

Task force report: The role of autonomy in DoD systems. (2012) U.S. Department of
Defense.
Transparency Market Research (2013) Medical Robotic Systems Market. Global
Industry Analysis, Size, Share, Growth, Trends and Forecast (2012-2018).

U

UN ST/ESA/SER.A/348 (2013) World Population Ageing 2013. United Nations,
Department of Economic and Social Affairs, Population Division.

4. Website Materials

A

Apple Speech Recognition System: Apple at <http://www.apple.com/ios/siri/>
Ambient Assisted Living: www.aal-europe.eu
Aquatic Therapy Lokomat: umrehabortho.org/research/ct/lokomat-aquatic-therapy
ASIMO: world.honda.com/ASIMO/
Autonomous Car Legislation, National Conference of State Legislatures, cfr.:
www.ncsl.org/research/transportation/autonomous-vehicles-legislation.aspx

B

Boston Dynamics: www.bostondynamics.com/robot_ls3.html
Butter, M. et al. (2008) Robotics for Healthcare. Available at:
https://ec.europa.eu/eip/ageing/library/robotics-healthcare_en

C

Caring Robots Summer School: lasallealmere.nl/course/caring-robots/
CEDIA, Smart Homes: www.cedia.org

Colin Angle's Speech in TedMed (2009): Will a Robot Care for my Mom?
www.tedmed.com/talks/show?id=7193

Cybercars: www.cybercars.fr.

Cyberdyne: www.cyberdyne.jp

Cyberdyne Hybrid Assistive Limb (HAL®):
www.cyberdyne.jp/english/products/HAL/

D

Drones for Good: www.alecmomont.com/projects/dronesforgood/

E

EC DG Health and Consumer Directorate B, Unit B2 "Cosmetics and medical devices":
ec.europa.eu/consumers/sectors/medical-devices/files/meddev/2_4_1_rev_9_classification_en.pdf

EUCog – European Framework for the Advancement of Artificial Cognitive Systems, IEE-RAS

European Privacy Seal: www.european-privacy-seal.eu/EPs-en/Home

European rules on drones: dronerules.eu/en/.

Exo-Legs EU Project: www.exo-legs.org/about.html

Exomed: www.exomed.org

F

Family Dog, New York Times:
www.nytimes.com/video/technology/100000003746796/the-family-dog.html

G

Google: www.google.com/about/company/.

H

Healthcare Robotics: Current Market Trends and Future Opportunities:
www.roboticsbusinessreview.com/health-medical/healthcare-robotics-current-market-trends-and-future-opportunities/

Hello Barbie Privacy Policy: www.toytalk.com/hellobarbie/privacy/.

Hocoma, Lokomat: www.hocoma.com/usa/us/products/lokomat/

Honda: world.honda.com/U3-X/

Housing Care: www.housingcare.org/jargon-personal-care-ea2e2.aspx

I

INCOTERM: iccwbo.org/resources-for-business/incoterms-rules/

INTEL IoT Wheelchair Project: www.intel.com/content/www/us/en/internet-of-things/videos/dr-hawkings-connected-wheelchair-video.html

Interactions and Robotics you will see that within the disciplines they deal with, there is also psychology. See www.eucognition.org/index.php?page=statistical-data

International Conference on Humanoid Robots: www.humanoids2016.org

International Federation of Robotics: www.ifr.org/service-robots/

International Standard Organization: www.iso.org

Instituto Robotica – Project Follow Me: institutorobotica.org/en/projects/follow-me/

J

Japanese robotic strategy: www.meti.go.jp/english/press/2015/pdf/0123_01b.pdf

Jeeves: projects.csail.mit.edu/jeeves/

JIBO: www.jibo.com

K

Klier, J. (2010) LabVIEW Robotics: Sense-Think-Act – Application Engineers
National Instruments NIDays Conference:

www.slideshare.net/mayankagarwal51/labview-robotics-sensethinkact

Knight Scope Robot: knightscope.com

L

Laboratoire des Systèmes Robotiques, EPFL: lsro.epfl.ch/page-118584-en.html

M

Masdar City Transportation: www.2getthere.eu/projects/masdar-prt/

Merriam-Webster Dictionary: www.merriam-webster.com/dictionary

MIT Intelligent Wheelchair project: rvsn.csail.mit.edu/wheelchair/

Moral Algorithms: the Ethics of Autonomous Vehicles (2016) at the Center for Ethics
and Human Values at the Ohio State University: [cehv.osu.edu/events/moral-
algorithms-conference](http://cehv.osu.edu/events/moral-algorithms-conference)

N

NASA: www.jpl.nasa.gov/msl/

O

Oxford Dictionary: www.oxforddictionaries.com/definition/english/definition

P

Panasonic News: news.panasonic.com/global/topics/2016/45099.html

Pepper robot: www.aldebaran.com/en/a-robots/who-is-pepper

Personal Rapid Transit Vehicles: www.skytran.com/prt/

R

Resyone Toyota: www.toyota-global.com/showroom/toyota_design/award/i_real/ and
news.panasonic.com/global/topics/2014/26411.html

Rewalk: rewalk.com

Rexbionics: www.rexbionics.com

RIBA Robot: rtc.nagoya.riken.jp/RIBA/index-e.html

RoboAutism CEEO Project: roboautism.k12engineering.com/?page_id=2

Roboethics Roadmap:
www.roboethics.org/atelier2006/docs/ROBOETHICS%20ROADMAP%20Rel2.1.1.pdf.
Robolaw Asia: www.robolaw.asia
Robolaw Project: www.robolaw.eu
Robotic Nurses project at Stanford university:
cs.stanford.edu/people/eroberts/cs201/projects/2010-11/ComputersMakingDecisions/robotic-nurses/index.html

S

Samsung Privacy policy:
www.samsung.com/sg/info/privacy/smarttv.html?CID=AFL-hq-mul-0813-11000170
Sapient project: www.sapientproject.eu
Segway patroller: www.segway.com/products/public-safety/se-3-patroller
Segwar Robot: robot.segway.com
Segway Tour Barcelona: www.barcelonasegwaytour.com/en/
Segway Tour Lithuania: www.lithuaniantours.com/en/travelers/special-offers/135-vilnius-segway-tour-package
Stop Killer Robots: www.stopkillerrobots.org/2013/04/campaign-launch-in-london/
Subcultron EU project: www.subcultron.eu
Suidoba Shijuko - Kuratas: suidobashijuko.jp

T

Tankchair: www.tankchair.com
Toyota Website: <http://www.toyota-global.com>

U

Union Internationale des Transports Publics (UITP), see: <http://www.uitp.org>
Unmanned Aircraft System, Federal Aviation Administration: www.faa.gov/uas/

W

Watson for Oncology, IBM: www.ibm.com/watson/health/oncology-and-genomics/oncology/
Werobot Conferences: robots.law.miami.edu
Werobot 2017 Conference: www.werobot2017.com
Workshop Series on the Ethical, Legal and Social Issues of Robots in Therapy and Education. Clarifying Legal Issues Involving Social and Non-Social Robots in Therapeutic and Educational Settings: legalaspectsofsocialrobots.wordpress.com
World Robot Declaration: www.prnewswire.co.uk/news-releases/world-robot-declaration-from-international-robot-fair-2004-organizing-office-154289895.html